

Keysight M9420A VXT Vector Transceiver

Notice: This document contains references to Agilent. Please note that Agilent's Test and Measurement business has become Keysight Technologies. For more information, go to www.keysight.com

N9072A cdma2000
Measurement
Application User's &
Programmer's
Reference

Notices

© Keysight Technologies, Inc. 2015

No part of this manual may be reproduced in any form or by any means (including electronic storage and retrieval or translation into a foreign language) without prior agreement and written consent from Keysight Technologies, Inc. as governed by United States and international copyright laws.

Trademark Acknowledgments

Manual Part Number

M9420-90010

Edition

Edition 1, August 2015

Published by:

Keysight Technologies

No 116 Tianfu 4th Street
Chengdu, China 610041

Warranty

THE MATERIAL CONTAINED IN THIS DOCUMENT IS PROVIDED "AS IS," AND IS SUBJECT TO BEING CHANGED, WITHOUT NOTICE, IN FUTURE EDITIONS. FURTHER, TO THE MAXIMUM EXTENT PERMITTED BY APPLICABLE LAW, KEYSIGHT DISCLAIMS ALL WARRANTIES, EITHER EXPRESS OR IMPLIED WITH REGARD TO THIS MANUAL AND ANY INFORMATION CONTAINED HEREIN, INCLUDING BUT NOT LIMITED TO THE IMPLIED WARRANTIES OF MERCHANTABILITY AND FITNESS FOR A PARTICULAR PURPOSE. KEYSIGHT SHALL NOT BE LIABLE FOR ERRORS OR FOR INCIDENTAL OR CONSEQUENTIAL DAMAGES IN CONNECTION WITH THE FURNISHING, USE, OR PERFORMANCE OF THIS DOCUMENT OR ANY INFORMATION CONTAINED HEREIN. SHOULD KEYSIGHT AND THE USER HAVE A SEPARATE WRITTEN AGREEMENT WITH WARRANTY TERMS COVERING THE MATERIAL IN THIS

DOCUMENT THAT CONFLICT WITH THESE TERMS, THE WARRANTY TERMS IN THE SEPARATE AGREEMENT WILL CONTROL.

Technology Licenses

The hardware and/or software described in this document are furnished under a license and may be used or copied only in accordance with the terms of such license.

U.S. Government Rights

The Software is "commercial computer software," as defined by Federal Acquisition Regulation ("FAR") 2.101. Pursuant to FAR 12.212 and 27.405-3 and Department of Defense FAR Supplement ("DFARS") 227.7202, the U.S. government acquires commercial computer software under the same terms by which the software is customarily provided to the public.

Accordingly, Keysight provides the Software to U.S. government customers under its standard commercial license, which is embodied in its End User License Agreement (EULA), a copy of which can be found at

<http://www.keysight.com/find/sweula>

The license set forth in the EULA represents the exclusive authority by which the U.S. government may use, modify, distribute, or disclose the Software. The EULA and the license set forth therein, does not require or permit, among other things, that Keysight: (1) Furnish technical information related to commercial computer software or commercial computer software documentation that is not customarily provided to the public; or (2) Relinquish to, or otherwise provide, the government rights in excess of these rights customarily provided to the public to use, modify, reproduce, release, perform, display, or disclose commercial computer software or commercial computer software documentation. No additional

government requirements beyond those set forth in the EULA shall apply, except to the extent that those terms, rights, or licenses are explicitly required from all providers of commercial computer software pursuant to the FAR and the DFARS and are set forth specifically in writing elsewhere in the EULA. Keysight shall be under no obligation to update, revise or otherwise modify the Software. With respect to any technical data as defined by FAR 2.101, pursuant to FAR 12.211 and 27.404.2 and DFARS 227.7102, the U.S. government acquires no greater than Limited Rights as defined in FAR 27.401 or DFAR 227.7103-5 (c), as applicable in any technical data.

Safety Notices

CAUTION

A **CAUTION** notice denotes a hazard. It calls attention to an operating procedure, practice, or the like that, if not correctly performed or adhered to, could result in damage to the product or loss of important data. Do not proceed beyond a CAUTION notice until the indicated conditions are fully understood and met.

WARNING

A **WARNING** notice denotes a hazard. It calls attention to an operating procedure, practice, or the like that, if not correctly performed or adhered to, could result in personal injury or death. Do not proceed beyond a WARNING notice until the indicated conditions are fully understood and met.

Table of Contents

N9072A cdma2000 Measurement Application User's & Programmer's Reference	i
Table of Contents	iii
1 About the Transceiver	65
Installing Application Software	66
Viewing a License Key	66
Obtaining and Installing a License Key	66
Updating Measurement Application Software	66
M9420A Options and Accessories	68
Virtual Front-Panel Features	69
Display Annotations	70
Window Control Keys	71
Virtual Front Panel	71
Windows Control Menu	71
Multi-Window	72
Zoom	72
Next Window	72
Full Screen	73
Display Enable (Remote Command Only)	74
Mouse and Keyboard Control	76
Right-Click	76
PC Keyboard	78
2 About the cdma2000 Measurement Application	81
What Does the cdma2000 Application Do?	82
3 Programming the Transceiver	83
What Programming Information is Available?	84
STATus Subsystem	85
Detailed Description	87
What Are Status Registers	88
What Are Status Register SCPI Commands	88
How to Use the Status Registers	89
Using a Status Register	90
Using the Service Request (SRQ) Method	91
Generating a Service Request	91
Status Register System	92
The Status Byte Register	93
Standard Event Status Register	95
Operation and Questionable Status Registers	97
Operation Status Register	97
Questionable Status Register	97
STATus Subsystem Command Descriptions	98

Operation Register	98
Operation Condition Query	98
Operation Enable	99
Operation Event Query	99
Operation Negative Transition	99
Operation Positive Transition	100
Preset the Status Byte	100
Questionable Register	101
Questionable Condition	101
Questionable Enable	101
Questionable Event Query	102
Questionable Negative Transition	102
Questionable Positive Transition	102
Questionable Calibration Register	103
Questionable Calibration Condition	103
Questionable Calibration Enable	103
Questionable Calibration Event Query	104
Questionable Calibration Negative Transition	104
Questionable Calibration Positive Transition	105
Questionable Calibration Skipped Register	105
Questionable Calibration Skipped Condition	105
Questionable Calibration Skipped Enable	106
Questionable Calibration Skipped Event Query	106
Questionable Calibration Skipped Negative Transition	107
Questionable Calibration Skipped Positive Transition	107
Questionable Calibration Extended Failure Register	107
Questionable Calibration Extended Failure Condition	108
Questionable Calibration Extended Failure Enable	108
Questionable Calibration Extended Failure Event Query	108
Questionable Calibration Extended Failure Negative Transition	109
Questionable Calibration Extended Failure Positive Transition	109
Questionable Calibration Extended Needed Register	110
Questionable Calibration Extended Needed Condition	110
Questionable Calibration Extended Needed Enable	110
Questionable Calibration Extended Needed Event Query	111
Questionable Calibration Extended Needed Negative Transition	111
Questionable Calibration Extended Needed Positive Transition	112
Questionable Frequency Register	112
Questionable Frequency Condition	112
Questionable Frequency Enable	113
Questionable Frequency Event Query	113
Questionable Frequency Negative Transition	113
Questionable Frequency Positive Transition	114

Questionable Integrity Register	114
Questionable Integrity Condition	114
Questionable Integrity Enable	115
Questionable Integrity Event Query	115
Questionable Integrity Negative Transition	116
Questionable Integrity Positive Transition	116
Questionable Integrity Signal Register	117
Questionable Integrity Signal Condition	117
Questionable Integrity Signal Enable	117
Questionable Integrity Signal Event Query	118
Questionable Integrity Signal Negative Transition	118
Questionable Integrity Signal Positive Transition	118
Questionable Integrity Uncalibrated Register	119
Questionable Integrity Uncalibrated Condition	119
Questionable Integrity Uncalibrated Enable	119
Questionable Integrity Uncalibrated Event Query	120
Questionable Integrity Uncalibrated Negative Transition	120
Questionable Integrity Uncalibrated Positive Transition	121
Questionable Power Register	121
Questionable Power Condition	121
Questionable Power Enable	122
Questionable Power Event Query	122
Questionable Power Negative Transition	123
Questionable Power Positive Transition	123
Questionable Temperature Register	123
Questionable Temperature Condition	124
Questionable Temperature Enable	124
Questionable Temperature Event Query	124
Questionable Temperature Negative Transition	125
Questionable Temperature Positive Transition	125
IEEE 488.2 Common Commands	127
All (Daily use)	127
Clear Status	129
Standard Event Status Enable	130
Standard Event Status Register Query	130
Identification Query	131
Operation Complete	131
Query Instrument Options	132
Recall Instrument State	133
*RST (Remote Command Only)	133
Save Instrument State	134
Service Request Enable	134
Status Byte Query	134

Trigger	135
Self Test Query	135
Wait-to-Continue	135
4 Input/Output Functions	137
Input/Output	138
Input/Output variables - Preset behavior	139
RF Input	140
Input Z Correction	140
RF Input Port	141
RF Input	142
External Gain	142
Ext Preamp	143
More Information	143
MS	144
BTS	145
Restore Input/Output Defaults	146
Data Source	146
Inputs	147
Capture Buffer	147
Current Meas -> Capture Buffer	148
Freq Ref In	148
External	150
Ext Ref Freq	150
RF Output & Test Set Config	151
RF Output	152
RF Output	152
Output Config	152
Trig Out	153
Polarity	153
Off	153
Sweeping (HSWP)	154
Measuring	154
Main Trigger	154
Gate Trigger	154
Gate	155
Odd/Even Trace Point	155
Trig Out	155
Off	156
Source Marker 1	156
Source Marker 2	156
Source Marker 3	156
Source Marker 4	157
Analog Out	157

More Information	157
Auto	158
Off	158
LISN Control	159
V-network (Remote Command Only)	159
Phase (Remote Command Only)	159
150 kHz Highpass (Remote Command Only)	160
Protective Earth (Remote Command Only)	160
5 Mode Functions	161
Mode	162
More Information	163
IQ Analyzer (Basic)	164
W-CDMA with HSPA+	164
GSM/EDGE/EDGE Evo	165
802.16 OFDMA (WiMAX/WiBro)	165
Vector Signal Analyzer (VXA)	165
Bluetooth	166
TD-SCDMA with HSPA/8PSK	166
cdma2000	166
1xEV-DO	167
WLAN	167
LTE-Advanced FDD	167
LTE-Advanced TDD	168
Application Mode Number Selection (Remote Command Only)	168
Application Mode Catalog Query (Remote Command Only)	169
Application Identification (Remote Commands Only)	169
Current Application Model	170
Current Application Revision	170
Current Application Options	170
Application Identification Catalog (Remote Commands Only)	171
Application Catalog Number of Entries	171
Application Catalog Model Numbers	171
Application Catalog Revision	171
Application Catalog Options	172
Detailed List of Modes	172
1xEV-DO	172
802.16 OFDMA (WiMAX/WiBro)	173
89601 VSA	173
Analog Demod	174
Bluetooth	174
cdma2000	174
GSM/EDGE/EDGE Evo	175
IQ Analyzer (Basic)	175

LTE	175
LTE TDD	176
LTE-Advanced FDD	176
LTE-Advanced TDD	176
Sequence Analyzer	177
TD-SCDMA with HSPA/8PSK	177
Vector Signal Analyzer (VXA)	177
W-CDMA with HSPA+	178
WLAN	178
Global Settings	178
Global Center Freq	179
Restore Defaults	179
Mode Setup	181
Radio	181
Device	181
Restore Mode Defaults	181
Preset Type (Remote Command Only)	182
6 System Functions	183
File	184
File Explorer	184
Page Setup	185
Print	186
Maximize	186
Minimize	186
Exit	187
Print	188
System	189
Show	189
Errors	189
Previous Page	190
Next Page	191
History	191
Verbose SCPI On/Off	191
Refresh	192
Clear Error Queue	192
Status	192
Input Overload Enable (Remote Command Only)	192
Power Up (Remote Command Only)	193
System	193
Show System contents (Remote Command Only)	194
Computer System description (Remote Command Only)	194
Hardware	195
System Remote Commands (Remote Commands Only)	196

System Powerdown (Remote Command Only)	197
System Log Off (Remote Command Only)	197
List installed Options (Remote Command Only)	197
Lock the Front-panel keys (Remote Command Only)	197
Front Panel activity history (Remote Command only)	198
SCPI activity history (Remote Command only)	198
Instrument start time (Remote Command only)	199
List SCPI Commands (Remote Command Only)	199
SCPI Version Query (Remote Command Only)	200
Date (Remote Command Only)	200
Time (Remote Command Only)	200
Module Name (Remote Command Only)	201
Module Index (Remote Command Only)	201
Module Mnemonic (Remote Command Only)	201
Module List (Remote Command Only)	202
Module Enable (Remote Command Only)	202
Module Default (Remote Command Only)	203
Module Model Number (Remote Command Only)	204
Module Model Serial Number (Remote Command Only)	204
Power On	204
Mode and Input/Output Defaults	205
User Preset	205
Last State	206
Power On Application	206
Configure Applications	207
Preloading Applications	208
Access to Configure Applications utility	208
Virtual memory usage	208
Select All	209
Deselect All	209
Move Up	209
Move Down	209
Select/Deselect	209
Save Changes and Exit	210
Exit Without Saving	210
Restore Power On Defaults	210
Configure Applications - Instrument boot-up	211
Configure Applications - Windows desktop	211
Configure Applications - Remote Commands	211
Configuration list (Remote Command Only)	212
Configuration Memory Available (Remote Command Only)	212
Configuration Memory Total (Remote Command Only)	212
Configuration Memory Used (Remote Command Only)	212

Configuration Application Memory (Remote Command Only)	213
Alignments	213
Align Now	213
All (Daily use)	213
All but RF	216
RF (Weekly use)	217
Source (Weekly use)	219
Show Alignment Statistics	220
Restore Align Defaults	223
Execute Expired Alignments (Remote Command Only)	224
I/O Config	225
SCPI LAN	225
SCPI Telnet	225
SCPI Socket	226
SICL Server	226
HiSLIP Server	227
SCPI Socket Control Port (Remote Command Only)	227
System IDN Response	228
Factory	228
User	229
Lock Remote I/O Session (Remote Command only)	229
Unlock Remote I/O Session (Remote Command only)	232
Remote I/O Session Lock Name (Remote Command only)	232
Remote I/O Session Lock Owner (Remote Command only)	233
Restore Defaults	233
Restore Input/Output Defaults	234
Restore Power On Defaults	234
Restore Align Defaults	235
Restore Misc Defaults	235
Restore Mode Defaults (All Modes)	236
All	237
Control Panel...	238
Licensing...	239
Security	241
USB	241
Read-Write	241
Read only	241
Diagnostics	242
Show Hardware Statistics	242
SCPI for Show Hardware Statistics (Remote Commands Only)	243
Self test	243
All Self Test	243
FEC Self Test	243

Show Result	244
Internet Explorer...	246
7 Trigger Functions	247
Trigger	248
Trigger Source Presets	249
RF Trigger Source	252
I/Q Trigger Source	253
More Information	254
Free Run	255
Video (IF Envelope)	256
Trigger Level	256
Trig Slope	257
Trig Delay	258
External 1	259
Trigger Level	260
Trig Slope	261
Trig Delay	261
Zero Span Delay Comp On/Off	262
External 2	262
Trigger Level	263
Trig Slope	263
Trig Delay	264
Zero Span Delay Comp On/Off	265
RF Burst	265
Absolute Trigger Level	266
Relative Trigger Level	267
Trigger Slope	268
Trig Delay	268
Periodic Timer (Frame Trigger)	269
Period	271
Offset	271
Offset Adjust (Remote Command Only)	272
Reset Offset Display	273
Sync Source	273
Off	274
External 1	274
External 2	276
RF Burst	278
Trig Delay	280
Auto/Holdoff	280
Auto Trig	281
Trig Holdoff	281
Internal	282

8 Channel Power Measurement	283
AMPTD Y Scale	287
Ref Value	287
Range	287
Range	288
Adjust Range For Min Clip	288
Pre-Adjust for Min Clip	288
Peak to Average	289
Mixer Level Offset	289
Scale/Div	290
Ref Position	290
Auto Scaling	291
Auto Couple	292
More Information	292
Auto/Man Active Function keys	292
Auto/Man 1-of-N keys	292
BW	294
Res BW	294
Video BW	295
Filter Type	297
Cont (Continuous Measurement/Sweep)	298
File	300
FREQ Channel	301
Center Freq	301
Center Frequency Presets	302
RF Center Freq	304
Ext Mix Center Freq	305
I/Q Center Freq	306
CF Step	306
Input/Output	309
Marker	310
Select Marker	310
Marker Type	310
Properties	311
Select Marker	311
Relative To	311
All Markers Off	312
Marker X Axis Value (Remote Command Only)	312
Marker X Axis Position (Remote Command Only)	312
Marker Y Axis Value (Remote Command only)	313
Backward Compatibility SCPI Commands	313
Marker Function	315
Marker To	316

Meas	317
Remote Measurement Functions	317
Measurement Group of Commands	318
Current Measurement Query (Remote Command Only)	320
Limit Test Current Results (Remote Command Only)	320
Data Query (Remote Command Only)	320
Calculate/Compress Trace Data Query (Remote Command Only)	321
Calculate Peaks of Trace Data (Remote Command Only)	326
Hardware-Accelerated Fast Power Measurement (Remote Command Only)	327
Reset Fast Power Measurement (Remote Command Only)	327
Define Fast Power Measurement (Remote Command Only)	328
Define Fast Power Measurement Query (Remote Command Only)	337
Configure Fast Power Measurement (Remote Command Only)	338
Initiate Fast Power Measurement (Remote Command Only)	339
Fetch Fast Power Measurement (Remote Command Only)	339
Execute Fast Power Measurement (Remote Command Only)	339
Binary Read Fast Power Measurement (Remote Command Only)	340
Diagnostic Binary Read Fast Power Measurement (Remote Command Only)	340
Format Data: Numeric Data (Remote Command Only)	341
Format Data: Byte Order (Remote Command Only)	342
Meas Setup	343
Avg/Hold Num	343
Avg Mode	344
Integ BW	345
Limits	346
Power Limit	346
PSD Limit	347
Power Limit Fail (remote command only)	348
PSD Limit Fail (remote command only)	349
Meas Preset	349
PSD Unit	349
Mode	351
Mode Preset	352
How-To Preset	353
Mode Setup	355
Peak Search	356
Print	357
Quick Save	358
Recall	360
State	360
More Information	362
From File...	362
Edit Register Names	364

Register 1 thru Register 16	364
Register 1 thru Register 16	365
Sequences	366
Source Sequence	366
Open...	367
Data (Import)	367
Capture Buffer	368
Open...	368
Restart	369
More Information	369
Save	371
State	371
To File . . .	372
Edit Register Names	374
More Information	374
Register 1 thru Register 16	375
Register 1 thru Register 16	375
Mass Storage Catalog (Remote Command Only)	376
Mass Storage Change Directory (Remote Command Only)	377
Mass Storage Copy (Remote Command Only)	377
Mass Storage Device Copy (Remote Command Only)	377
Mass Storage Delete (Remote Command Only)	378
Mass Storage Data (Remote Command Only)	378
Mass Storage Make Directory (Remote Command Only)	378
Mass Storage Move (Remote Command Only)	378
Mass Storage Remove Directory (Remote Command Only)	379
Mass Storage Determine Removable Media (Remote Command Only)	379
Mass Storage Determine Removable Media Label (Remote Command Only)	380
Mass Storage Determine Removable Media Write-protect status (Remote Command Only)	380
Mass Storage Determine Removable Media size (Remote Command Only)	380
Sequences	381
Source Sequence	381
Save As . . .	381
Data (Export)	382
Measurement Results	382
Capture Buffer	385
Save As . . .	386
Screen Image	386
Themes	387
3D Color	388
3D Monochrome	388
Flat Color	388

Flat Monochrome	389
Save As...	389
Single (Single Measurement/Sweep)	390
More Information	390
Source	391
RF Output	391
Amplitude	391
RF Power	392
RF Power Range	393
RF Power Range	393
Set Reference Power	393
Power Ref	394
Amptd Offset	394
Modulation	395
Frequency	396
Frequency	396
Channel	397
GSM/EDGE Channel Number Ranges	397
W-CDMA Channel Number Ranges	398
CDMA 2000 / 1xEVDO Channel Number Ranges	400
LTE FDD Channel Number Ranges	402
LTE TDD Channel Number Ranges	403
TDSCDMA Channel Number Ranges	404
Radio Setup	405
Radio Standard	405
Radio Band Link	420
Set Reference Frequency	421
Freq Reference	422
Freq Offset	422
Modulation Setup	423
ARB	423
ARB	424
Select Waveform	424
ARB Setup	429
Trigger Type	434
ARB	437
Trigger Initiate	439
Waveform Sequences	439
Waveform Utilities	447
Marker Utilities	452
Header Utilities	457
AM	458
AM	458

Table of Contents

AM Depth	459
AM Rate	459
FM	459
FM	460
FM Deviation	460
FM Rate	460
PM	461
PM	461
PM Deviation	461
PM Rate	461
List Sequencer	462
Sequencer	462
Initiate Sequence	463
List Sequencer Setup	463
Number of Steps	463
Current Step	464
Insert Step Before	464
Delete Step	464
Clear List	465
Step Trigger	465
Transition Time	467
Radio Setup	467
Channel	482
Frequency	482
Power	483
Waveform	483
Step Duration	489
Output Trigger	491
Repetition	491
Single	491
Continuous	492
Trigger Type	492
BeginningOfStep	492
DataMarker	493
Manual Trigger Now	494
Source Preset	494
Span X Scale	495
Span	495
Full Span	496
Last Span	497
Sweep/Control	498
Sweep Time	498
Sweep Setup	499

Auto Sweep Time Rules	499
Pause	500
Gate	500
Gate On/Off	500
Gate View On/Off	501
Gate View Setup	504
Gate View Acquisition Time	504
Gate View Start Time	505
Gate Delay	505
Gate Length	506
Gate Source	506
Video (IF Envelope)	507
External 1	509
External 2	511
RF Burst	514
Periodic Timer (Frame Trigger)	517
Auto/Holdoff	528
Gate Preset (Remote Command Only)	529
Gate Level (Remote Command Only)	530
Gate Polarity (Remote Command Only)	530
Points	530
System	532
Trace/Detector	533
Trace Type	533
Detector	533
Auto	534
Detector Selection	534
Trigger	536
Free Run	536
Video	536
Trigger Level	536
Trig Slope	536
Trig Delay	536
External 1	536
Trigger Level	536
Trig Slope	536
Trig Delay	536
Zero Span Delay Comp	536
External 2	536
Trigger Level	536
Trig Slope	536
Trig Delay	537
Zero Span Delay Comp	537

RF Burst	537
Absolute Trigger	537
Relative Trigger	537
Trig Slope	537
Trig Delay	537
Periodic Timer	537
Period	537
Offset	537
Offset Adjust (Remote Command Only)	537
Reset Offset Display	537
Sync Source	537
Off	537
External 1	538
External 2	538
RF Burst	538
Trig Delay	538
Auto/Holdoff	538
Auto Trig	538
Trig Holdoff	538
Internal	538
User Preset	539
User Preset	539
User Preset All Modes	540
Save User Preset	541
View/Display	542
Display	544
Annotation	545
Meas Bar On/Off	546
Screen	546
Active Function Values On/Off	546
Title	547
Change Title	548
Clear Title	548
Graticule	549
System Display Settings	549
Annotation Local Settings	549
Themes	550
Bar Graph	551
9 ACP Measurement	553
AMPTD Y Scale	565
Ref Value	565
Range	565
Range	566

Adjust Range For Min Clip	566
Pre-Adjust for Min Clip	566
Peak to Average	567
Mixer Level Offset	567
Scale/Div	568
Ref Position	568
Auto Scaling	569
Auto Couple	570
More Information	570
Auto/Man Active Function keys	570
Auto/Man 1-of-N keys	570
BW	572
Res BW	572
Video BW	573
RBW Control	575
Filter Type	575
Filter BW	576
Cont (Continuous Measurement/Sweep)	577
File	579
FREQ Channel	580
Center Freq	580
Center Frequency Presets	581
RF Center Freq	583
Ext Mix Center Freq	584
I/Q Center Freq	585
CF Step	585
Input/Output	588
Marker	589
Select Marker	589
Marker Type	589
Properties	590
Select Marker	590
Relative To	590
Marker Trace	591
Couple Markers	592
Marker All Off	592
Marker X Axis Value (Remote Command only)	592
Marker X Axis Position (Remote Command only)	593
Marker Y Axis Value (Remote Command only)	594
Backward Compatibility Remote Commands	594
Marker Function	595
Marker To	596
Meas	597

Remote Measurement Functions	597
Measurement Group of Commands	598
Current Measurement Query (Remote Command Only)	600
Limit Test Current Results (Remote Command Only)	600
Data Query (Remote Command Only)	600
Calculate/Compress Trace Data Query (Remote Command Only)	601
Calculate Peaks of Trace Data (Remote Command Only)	606
Hardware-Accelerated Fast Power Measurement (Remote Command Only)	607
Reset Fast Power Measurement (Remote Command Only)	607
Define Fast Power Measurement (Remote Command Only)	608
Define Fast Power Measurement Query (Remote Command Only)	617
Configure Fast Power Measurement (Remote Command Only)	618
Initiate Fast Power Measurement (Remote Command Only)	619
Fetch Fast Power Measurement (Remote Command Only)	619
Execute Fast Power Measurement (Remote Command Only)	619
Binary Read Fast Power Measurement (Remote Command Only)	620
Diagnostic Binary Read Fast Power Measurement (Remote Command Only)	620
Format Data: Numeric Data (Remote Command Only)	621
Format Data: Byte Order (Remote Command Only)	622
Meas Setup	623
Average/Hold Number	623
Avg Mode	624
Carrier Setup (This menu is unavailable in MSR)	624
Carriers	624
Ref Carrier	625
Ref Car Freq	626
Power Ref	627
Total Power	628
PSD	629
Configure Carriers	630
Carrier	630
Carrier Pwr Present	630
Carrier Spacing	631
Measurement Noise Bandwidth	632
Carrier Coupling	634
Offset/Limits	635
Select Offset	635
Offset Freq	635
Integ BW	637
Offset BW	638
Res BW	639
Video BW	640
RBW Control	641

Limits	642
Select Offset	642
Abs Limit	642
Rel Lim (Car)	643
Rel Limit (PSD)	646
Fail Mask	647
Offset Side	648
Offset Frequency Define	649
Carrier Result	650
Meas Method	651
Meas Type	652
PSD Ref	653
Limit Test	653
Meas Preset	654
Offset RRC Weighting (Backward Compatibility SCPI)	655
Offset Filter Alpha (Backward Compatibility SCPI)	655
Method for Carrier (Backward Compatibility SCPI)	656
Mode	658
Mode Preset	659
How-To Preset	660
Mode Setup	662
Peak Search	663
Next Peak	663
Next Pk Right	663
Next Pk Left	664
Marker Delta	664
Pk-Pk Search	664
Min Search	664
Print	666
Quick Save	667
Recall	669
State	669
More Information	671
From File...	671
Edit Register Names	673
Register 1 thru Register 16	673
Register 1 thru Register 16	674
Sequences	675
Source Sequence	675
Open...	676
Data (Import)	676
Capture Buffer	677
Open...	677

Restart	678
More Information	678
Save	680
State	680
To File . . .	681
Edit Register Names	683
More Information	683
Register 1 thru Register 16	684
Register 1 thru Register 16	684
Mass Storage Catalog (Remote Command Only)	685
Mass Storage Change Directory (Remote Command Only)	686
Mass Storage Copy (Remote Command Only)	686
Mass Storage Device Copy (Remote Command Only)	686
Mass Storage Delete (Remote Command Only)	687
Mass Storage Data (Remote Command Only)	687
Mass Storage Make Directory (Remote Command Only)	687
Mass Storage Move (Remote Command Only)	687
Mass Storage Remove Directory (Remote Command Only)	688
Mass Storage Determine Removable Media (Remote Command Only)	688
Mass Storage Determine Removable Media Label (Remote Command Only)	689
Mass Storage Determine Removable Media Write-protect status (Remote Command Only)	689
Mass Storage Determine Removable Media size (Remote Command Only)	689
Sequences	690
Source Sequence	690
Save As . . .	690
Data (Export)	691
Measurement Results	691
Capture Buffer	699
Save As . . .	700
Screen Image	701
Themes	702
3D Color	702
3D Monochrome	702
Flat Color	703
Flat Monochrome	703
Save As...	703
Single (Single Measurement/Sweep)	704
More Information	704
Source	705
RF Output	705
Amplitude	705
RF Power	706

RF Power Range	707
RF Power Range	707
Set Reference Power	707
Power Ref	708
Amptd Offset	708
Modulation	709
Frequency	710
Frequency	710
Channel	711
GSM/EDGE Channel Number Ranges	711
W-CDMA Channel Number Ranges	712
CDMA 2000 / 1xEVDO Channel Number Ranges	714
LTE FDD Channel Number Ranges	716
LTE TDD Channel Number Ranges	717
TDSCDMA Channel Number Ranges	718
Radio Setup	719
Radio Standard	719
Radio Band Link	734
Set Reference Frequency	735
Freq Reference	736
Freq Offset	736
Modulation Setup	737
ARB	737
ARB	738
Select Waveform	738
ARB Setup	743
Trigger Type	748
ARB	751
Trigger Initiate	753
Waveform Sequences	753
Waveform Utilities	761
Marker Utilities	766
Header Utilities	771
AM	772
AM	772
AM Depth	773
AM Rate	773
FM	773
FM	774
FM Deviation	774
FM Rate	774
PM	775
PM	775

Table of Contents

PM Deviation	775
PM Rate	775
List Sequencer	776
Sequencer	776
Initiate Sequence	777
List Sequencer Setup	777
Number of Steps	777
Current Step	778
Insert Step Before	778
Delete Step	778
Clear List	779
Step Trigger	779
Transition Time	781
Radio Setup	781
Channel	796
Frequency	796
Power	797
Waveform	797
Step Duration	803
Output Trigger	805
Repetition	805
Single	805
Continuous	806
Trigger Type	806
BeginningOfStep	806
DataMarker	807
Manual Trigger Now	808
Source Preset	808
SPAN X Scale	809
Span	809
Full Span	810
Last Span	810
Sweep/Control	811
Sweep Time	811
Sweep Setup	812
Auto Sweep Time Rules	813
Pause	813
Gate	813
Gate On/Off	814
Gate View On/Off	815
Gate View Setup	817
Gate View Acquisition Time	817
Gate View Start Time	818

Gate Delay	818
Gate Length	819
Gate Source	819
Video (IF Envelope)	820
External 1	822
External 2	824
RF Burst	827
Periodic Timer (Frame Trigger)	830
Auto/Holdoff	841
Gate Preset (Remote Command Only)	842
Gate Level (Remote Command Only)	843
Gate Polarity (Remote Command Only)	843
Points	843
System	845
Trace/Detector	846
Select Trace (Front-panel Only)	846
Trace Type	846
View/Blank	847
Detector	848
Auto	849
Detector Selection	849
Trigger	851
Free Run	851
Video	851
Trigger Level	851
Trig Slope	851
Trig Delay	851
External 1	851
Trigger Level	851
Trig Slope	851
Trig Delay	851
Zero Span Delay Comp	851
External 2	851
Trigger Level	851
Trig Slope	851
Trig Delay	852
Zero Span Delay Comp	852
RF Burst	852
Absolute Trigger	852
Relative Trigger	852
Trig Slope	852
Trig Delay	852
Periodic Timer	852

Period	852
Offset	852
Reset Offset Display	852
Sync Source	852
Off	852
External 1	852
External 2	853
RF Burst	853
Trig Delay	853
Auto/Holdoff	853
Auto Trig	853
Trig Holdoff	853
Internal	853
User Preset	854
User Preset	854
User Preset All Modes	855
Save User Preset	856
View/Display	857
Spectrum Window	859
Results Window	859
Display	861
Annotation	861
Meas Bar On/Off	862
Screen	863
Active Function Values On/Off	863
Title	864
Change Title	864
Clear Title	865
Graticule	866
System Display Settings	866
Annotation Local Settings	866
Themes	867
Bar Graph	868
10 Spectrum Emission Mask Measurement	871
AMPTD Y Scale	894
Ref Value	894
Range	894
Range	895
Adjust Range For Min Clip	895
Pre-Adjust for Min Clip	895
Peak to Average	896
Mixer Level Offset	896
Scale/Div	897

Ref Position	897
Auto Scaling	898
Auto Couple	899
More Information	899
Auto/Man Active Function keys	899
Auto/Man 1-of-N keys	899
BW	901
Filter Type	901
Cont (Continuous Measurement/Sweep)	902
File	904
FREQ Channel	905
Center Freq	905
Center Frequency Presets	906
RF Center Freq	908
Ext Mix Center Freq	909
I/Q Center Freq	910
CF Step	910
Input/Output	913
Marker	914
Select Marker	914
Marker Type	914
Couple Markers	915
All Markers Off	915
Marker X Axis Value (Remote Command Only)	915
Marker X Axis Position (Remote Command Only)	916
Marker Y Axis Value (Remote Command Only)	917
Marker Function	918
Marker To	919
Meas	920
Remote Measurement Functions	920
Measurement Group of Commands	921
Current Measurement Query (Remote Command Only)	923
Limit Test Current Results (Remote Command Only)	923
Data Query (Remote Command Only)	923
Calculate/Compress Trace Data Query (Remote Command Only)	924
Calculate Peaks of Trace Data (Remote Command Only)	929
Hardware-Accelerated Fast Power Measurement (Remote Command Only)	930
Reset Fast Power Measurement (Remote Command Only)	930
Define Fast Power Measurement (Remote Command Only)	931
Define Fast Power Measurement Query (Remote Command Only)	940
Configure Fast Power Measurement (Remote Command Only)	941
Initiate Fast Power Measurement (Remote Command Only)	942
Fetch Fast Power Measurement (Remote Command Only)	942

Execute Fast Power Measurement (Remote Command Only)	942
Binary Read Fast Power Measurement (Remote Command Only)	943
Diagnostic Binary Read Fast Power Measurement (Remote Command Only)	943
Format Data: Numeric Data (Remote Command Only)	944
Format Data: Byte Order (Remote Command Only)	945
Meas Setup	946
Avg/Hold Num	946
Meas Type	946
Ref Channel	947
Integ BW	947
Span	948
Sweep Time	950
Power Ref (for the modes except MSR and LTE-Advanced FDD/TDD)	950
Total Power	951
PSD	951
Spectrum Peak	952
Res BW	953
Video BW	954
VBW/RBW	956
Offset/Limits	957
Select Offset	957
Start Freq	957
Stop Freq	960
Sweep Time	962
Offset Side	963
Res BW	964
Meas BW	966
Video BW	967
VBW/RBW	968
Limits	970
Select Offset	970
Abs Start	970
Abs Stop	972
Rel Start	975
Rel Stop	977
Fail Mask	979
Offset Freq Define	981
Meas Preset	983
Mode	984
Mode Preset	985
How-To Preset	986
Mode Setup	988
Peak Search	989

Print	990
Quick Save	991
Recall	993
State	993
More Information	995
From File...	995
Edit Register Names	997
Register 1 thru Register 16	997
Register 1 thru Register 16	998
Sequences	999
Source Sequence	999
Open...	1000
Data (Import)	1000
Capture Buffer	1001
Open...	1001
Restart	1002
More Information	1002
Save	1004
State	1004
To File . . .	1005
Edit Register Names	1007
More Information	1007
Register 1 thru Register 16	1008
Register 1 thru Register 16	1008
Mass Storage Catalog (Remote Command Only)	1009
Mass Storage Change Directory (Remote Command Only)	1010
Mass Storage Copy (Remote Command Only)	1010
Mass Storage Device Copy (Remote Command Only)	1010
Mass Storage Delete (Remote Command Only)	1011
Mass Storage Data (Remote Command Only)	1011
Mass Storage Make Directory (Remote Command Only)	1011
Mass Storage Move (Remote Command Only)	1011
Mass Storage Remove Directory (Remote Command Only)	1012
Mass Storage Determine Removable Media (Remote Command Only)	1012
Mass Storage Determine Removable Media Label (Remote Command Only)	1013
Mass Storage Determine Removable Media Write-protect status (Remote Command Only)	1013
Mass Storage Determine Removable Media size (Remote Command Only)	1013
Sequences	1014
Source Sequence	1014
Save As . . .	1014
Data (Export)	1015
Measurement Results	1015

Table of Contents

Meas Results File Contents	1016
Capture Buffer	1025
Save As . . .	1026
Screen Image	1026
Themes	1027
3D Color	1028
3D Monochrome	1028
Flat Color	1028
Flat Monochrome	1029
Save As...	1029
Single (Single Measurement/Sweep)	1030
More Information	1030
Source	1031
RF Output	1031
Amplitude	1031
RF Power	1032
RF Power Range	1033
RF Power Range	1033
Set Reference Power	1033
Power Ref	1034
Amptd Offset	1034
Modulation	1035
Frequency	1036
Frequency	1036
Channel	1037
GSM/EDGE Channel Number Ranges	1037
W-CDMA Channel Number Ranges	1038
CDMA 2000 / 1xEVDO Channel Number Ranges	1040
LTE FDD Channel Number Ranges	1042
LTE TDD Channel Number Ranges	1043
TDSCDMA Channel Number Ranges	1044
Radio Setup	1045
Radio Standard	1045
Radio Band Link	1060
Set Reference Frequency	1061
Freq Reference	1062
Freq Offset	1062
Modulation Setup	1063
ARB	1063
ARB	1064
Select Waveform	1064
ARB Setup	1069
Trigger Type	1074

ARB	1077
Trigger Initiate	1079
Waveform Sequences	1079
Waveform Utilities	1087
Marker Utilities	1092
Header Utilities	1097
AM	1098
AM	1098
AM Depth	1099
AM Rate	1099
FM	1099
FM	1100
FM Deviation	1100
FM Rate	1100
PM	1101
PM	1101
PM Deviation	1101
PM Rate	1101
List Sequencer	1102
Sequencer	1102
Initiate Sequence	1103
List Sequencer Setup	1103
Number of Steps	1103
Current Step	1104
Insert Step Before	1104
Delete Step	1104
Clear List	1105
Step Trigger	1105
Transition Time	1107
Radio Setup	1107
Channel	1122
Frequency	1122
Power	1123
Waveform	1123
Step Duration	1129
Output Trigger	1131
Repetition	1131
Single	1131
Continuous	1132
Trigger Type	1132
BeginningOfStep	1132
DataMarker	1133
Manual Trigger Now	1134

Table of Contents

Source Preset	1134
Span X Scale	1135
Ref Value	1135
Scale/Div	1135
Ref Position	1136
Auto Scaling	1136
Sweep/Control	1138
Pause	1138
Gate	1138
Gate On/Off	1138
Gate View On/Off	1139
Gate View Setup	1142
Gate View Acquisition Time	1142
Gate View Start Time	1143
Gate Delay	1143
Gate Length	1144
Gate Source	1144
Video (IF Envelope)	1145
External 1	1147
External 2	1149
RF Burst	1152
Periodic Timer (Frame Trigger)	1155
Auto/Holdoff	1166
Gate Preset (Remote Command Only)	1167
Gate Level (Remote Command Only)	1168
Gate Polarity (Remote Command Only)	1168
System	1169
Trace/Detector	1170
Trace Type	1170
Chan Detector	1170
Chan Detector Auto	1171
Chan Detector Selection	1171
Offset Detector	1172
Offset Detector Auto	1172
Offset Detector Selection	1173
Trigger	1174
Free Run	1174
Video	1174
Trigger Level	1174
Trig Slope	1174
Trig Delay	1174
External 1	1174
Trigger Level	1174

Trig Slope	1174
Trig Delay	1174
Zero Span Delay Comp	1174
External 2	1174
Trigger Level	1174
Trig Slope	1174
Trig Delay	1175
Zero Span Delay Comp	1175
RF Burst	1175
Absolute Trigger	1175
Relative Trigger	1175
Trig Slope	1175
Trig Delay	1175
Periodic Timer	1175
Period	1175
Offset	1175
Offset Adjust (Remote Command Only)	1175
Reset Offset Display	1175
Sync Source	1175
Off	1175
External 1	1176
External 2	1176
RF Burst	1176
Trig Delay	1176
Auto/Holdoff	1176
Auto Trig	1176
Trig Holdoff	1176
Internal	1176
User Preset	1177
User Preset	1177
User Preset All Modes	1178
Save User Preset	1179
View/Display	1180
View Selection by Name (Remote Command Only)	1180
Views Selection by Number (Remote Command only)	1181
Display	1181
Annotation	1182
Meas Bar On/Off	1183
Screen	1184
Active Function Values On/Off	1184
Title	1185
Change Title	1185
Clear Title	1186

Graticule	1187
System Display Settings	1187
Annotation Local Settings	1187
Themes	1188
Abs Pwr Freq	1189
Abs Peak Pwr & Freq (Total Pwr Ref)	1189
Trace Window	1191
Results Window	1191
Abs Peak Pwr & Freq (PSD Ref)	1191
Trace Window	1193
Results Window	1193
Abs Peak Pwr & Freq (Spectrum Pk Ref)	1193
Trace Window	1195
Results Window	1195
Rel Pwr Freq	1195
Rel Peak Pwr & Freq (Total Pwr Ref)	1195
Trace Window	1196
Results Window	1196
Rel Peak Pwr & Freq (PSD Ref)	1197
Trace Window	1197
Results Window	1198
Rel Peak Pwr & Freq (Spectrum Pk Ref)	1198
Trace Window	1199
Results Window	1199
Integrated Power	1200
Integrated Power (Total Pwr Ref)	1200
Trace Window	1202
Results Window	1202
Integrated Power (PSD Ref)	1203
Trace Window	1205
Results Window	1205
Integrated Power (Spectrum Pk Ref)	1206
Trace Window	1207
Results Window	1207
Limit Lines	1208
11 Occupied Bandwidth Measurement	1209
AMPTD Y Scale (Amplitude/Y Scale)	1212
Ref Value	1212
Range	1212
Range	1213
Adjust Range For Min Clip	1213
Pre-Adjust for Min Clip	1213
Peak to Average	1214

Mixer Level Offset	1214
Scale/Div	1215
Ref Position	1216
Auto Scaling	1216
Auto Couple	1218
More Information	1218
Auto/Man Active Function keys	1218
Auto/Man 1-of-N keys	1218
BW	1220
Res BW	1220
Video BW	1221
Filter Type	1222
Cont (Continuous Measurement/Sweep)	1224
Display	1226
Display	1226
Annotation	1226
Meas Bar On/Off	1227
Screen	1228
Active Function Values On/Off	1228
Title	1229
Change Title	1229
Clear Title	1230
Graticule	1231
System Display Settings	1231
Annotation Local Settings	1231
Themes	1232
Boundary Frequency	1233
x dB BW Boundaries	1234
File	1235
FREQ Channel	1236
Center Freq	1236
Center Frequency Presets	1237
RF Center Freq	1239
Ext Mix Center Freq	1240
I/Q Center Freq	1241
CF Step	1241
Input/Output	1244
Marker	1245
Select Marker	1245
Select Marker	1245
Marker Type	1245
Properties	1246
Select Marker	1246

Select Marker	1246
Relative To	1246
All Markers Off	1247
Marker X Axis Value (Remote Command Only)	1247
Marker X Axis Position (Remote Command Only)	1248
Marker Y Axis Value (Remote Command Only)	1248
Backward Compatibility SCPI Commands	1249
Marker Function	1250
Marker To	1251
Meas	1252
Remote Measurement Functions	1252
Measurement Group of Commands	1253
Current Measurement Query (Remote Command Only)	1255
Limit Test Current Results (Remote Command Only)	1255
Data Query (Remote Command Only)	1255
Calculate/Compress Trace Data Query (Remote Command Only)	1256
Calculate Peaks of Trace Data (Remote Command Only)	1261
Hardware-Accelerated Fast Power Measurement (Remote Command Only)	1262
Reset Fast Power Measurement (Remote Command Only)	1262
Define Fast Power Measurement (Remote Command Only)	1263
Define Fast Power Measurement Query (Remote Command Only)	1272
Configure Fast Power Measurement (Remote Command Only)	1273
Initiate Fast Power Measurement (Remote Command Only)	1274
Fetch Fast Power Measurement (Remote Command Only)	1274
Execute Fast Power Measurement (Remote Command Only)	1274
Binary Read Fast Power Measurement (Remote Command Only)	1275
Diagnostic Binary Read Fast Power Measurement (Remote Command Only)	1275
Format Data: Numeric Data (Remote Command Only)	1276
Format Data: Byte Order (Remote Command Only)	1277
Meas Setup	1278
Avg/Hold Num	1278
Avg Mode	1279
Occ BW % Pwr	1279
Power Ref	1280
x dB	1280
Limit (for all modes except MSR and LTE-Advanced FDD/TDD)	1281
Meas Preset	1282
Max Hold (Remote Command Only)	1283
Mode	1284
Mode Preset	1285
How-To Preset	1286
Mode Setup	1288
Peak Search	1289

Print	1290
Quick Save	1291
Recall	1293
State	1293
More Information	1295
From File...	1295
Edit Register Names	1297
Register 1 thru Register 16	1297
Register 1 thru Register 16	1298
Sequences	1299
Source Sequence	1299
Open...	1300
Data (Import)	1300
Capture Buffer	1301
Open...	1301
Restart	1302
More Information	1302
Save	1304
State	1304
To File . . .	1305
Edit Register Names	1307
More Information	1307
Register 1 thru Register 16	1308
Register 1 thru Register 16	1308
Mass Storage Catalog (Remote Command Only)	1309
Mass Storage Change Directory (Remote Command Only)	1310
Mass Storage Copy (Remote Command Only)	1310
Mass Storage Device Copy (Remote Command Only)	1310
Mass Storage Delete (Remote Command Only)	1311
Mass Storage Data (Remote Command Only)	1311
Mass Storage Make Directory (Remote Command Only)	1311
Mass Storage Move (Remote Command Only)	1311
Mass Storage Remove Directory (Remote Command Only)	1312
Mass Storage Determine Removable Media (Remote Command Only)	1312
Mass Storage Determine Removable Media Label (Remote Command Only)	1313
Mass Storage Determine Removable Media Write-protect status (Remote Command Only)	1313
Mass Storage Determine Removable Media size (Remote Command Only)	1313
Sequences	1314
Source Sequence	1314
Save As . . .	1314
Data (Export)	1315
Measurement Results	1315

Meas Results File Definition	1316
Meas Results File Example	1317
Capture Buffer	1318
Save As . . .	1319
Screen Image	1319
Themes	1320
3D Color	1321
3D Monochrome	1321
Flat Color	1321
Flat Monochrome	1322
Save As...	1322
Single (Single Measurement/Sweep)	1323
More Information	1323
Source	1324
RF Output	1324
Amplitude	1324
RF Power	1325
RF Power Range	1326
RF Power Range	1326
Set Reference Power	1326
Power Ref	1327
Amptd Offset	1327
Modulation	1328
Frequency	1329
Frequency	1329
Channel	1330
GSM/EDGE Channel Number Ranges	1330
W-CDMA Channel Number Ranges	1331
CDMA 2000 / 1xEVDO Channel Number Ranges	1333
LTE FDD Channel Number Ranges	1335
LTE TDD Channel Number Ranges	1336
TDSCDMA Channel Number Ranges	1337
Radio Setup	1338
Radio Standard	1338
Radio Band Link	1353
Set Reference Frequency	1354
Freq Reference	1355
Freq Offset	1355
Modulation Setup	1356
ARB	1356
ARB	1357
Select Waveform	1357
ARB Setup	1362

Trigger Type	1367
ARB	1370
Trigger Initiate	1372
Waveform Sequences	1372
Waveform Utilities	1380
Marker Utilities	1385
Header Utilities	1390
AM	1391
AM	1391
AM Depth	1392
AM Rate	1392
FM	1392
FM	1393
FM Deviation	1393
FM Rate	1393
PM	1394
PM	1394
PM Deviation	1394
PM Rate	1394
List Sequencer	1395
Sequencer	1395
Initiate Sequence	1396
List Sequencer Setup	1396
Number of Steps	1396
Current Step	1397
Insert Step Before	1397
Delete Step	1397
Clear List	1398
Step Trigger	1398
Transition Time	1400
Radio Setup	1400
Channel	1415
Frequency	1415
Power	1416
Waveform	1416
Step Duration	1422
Output Trigger	1424
Repetition	1424
Single	1424
Continuous	1425
Trigger Type	1425
BeginningOfStep	1425
DataMarker	1426

Table of Contents

Manual Trigger Now	1427
Source Preset	1427
Span X Scale	1428
Span	1428
Full Span	1429
Last Span	1429
Sweep/Control	1431
Sweep Time	1431
Sweep Setup	1432
Auto Sweep Time Rules	1432
Pause	1433
Gate	1433
Gate On/Off	1433
Gate View On/Off	1434
Gate View Setup	1437
Gate View Acquisition Time	1437
Gate View Start Time	1437
Gate Delay	1438
Gate Length	1438
Gate Source	1439
Video (IF Envelope)	1440
External 1	1442
External 2	1444
RF Burst	1446
Periodic Timer (Frame Trigger)	1449
Auto/Holdoff	1460
Gate Preset (Remote Command Only)	1462
Gate Level (Remote Command Only)	1462
Gate Polarity (Remote Command Only)	1462
Points	1463
System	1465
Trace/Detector	1466
Trace Type	1466
Detector	1466
Auto	1467
Detector Selection	1467
Trigger	1469
Free Run	1469
Video	1469
Trigger Level	1469
Trig Slope	1469
Trig Delay	1469
External 1	1469

Trigger Level	1469
Trig Slope	1469
Trig Delay	1469
Zero Span Delay Comp	1469
External 2	1469
Trigger Level	1469
Trig Slope	1469
Trig Delay	1470
Zero Span Delay Comp	1470
RF Burst	1470
Absolute Trigger	1470
Relative Trigger	1470
Trig Slope	1470
Trig Delay	1470
Periodic Timer	1470
Period	1470
Offset	1470
Reset Offset Display	1470
Sync Source	1470
Off	1470
External 1	1470
External 2	1471
RF Burst	1471
Trig Delay	1471
Auto/Holdoff	1471
Auto Trig	1471
Trig Holdoff	1471
Internal	1471
User Preset	1472
User Preset	1472
User Preset All Modes	1473
Save User Preset	1474
12 Code Domain Measurement	1475
AMPTD Y Scale	1483
Range	1483
Range	1483
Adjust Range For Min Clip	1484
Pre-Adjust for Min Clip	1484
Peak to Average	1484
Mixer Level Offset	1485
Power Graph & Metrics View CDP Window Y Scale/Div	1485
YRef Position	1486
I/Q Error View Mag Error Window Y Ref Position	1486

I/Q Error View Phase Error Window Y Ref Position	1486
I/Q Error View Evm Window Y Ref Position	1487
Code Domain View Symbol Power Window Y Ref Position	1487
Demod Bits View Symbol Power Window Y Ref Position	1488
Auto Scaling	1488
I/Q Error View Mag Error Window Y Auto Scaling	1489
I/Q Error View Phase Error Window Y Auto Scaling	1489
I/Q Error View Evm Window Y Auto Scaling	1490
Code Domain View Symbol Power Window Y Auto Scaling	1490
Demod Bits View Symbol Power Window Y Auto Scaling	1491
Auto Couple	1492
More Information	1492
Auto/Man Active Function keys	1492
Auto/Man 1-of-N keys	1492
BW	1494
Cont (Continuous Measurement/Sweep)	1495
File	1497
FREQ Channel	1498
Center Freq	1498
Center Frequency Presets	1499
RF Center Freq	1501
Ext Mix Center Freq	1502
I/Q Center Freq	1503
CF Step	1503
Input/Output	1506
Marker	1507
Select Marker	1507
Marker Type	1507
Properties	1508
Select Marker	1508
Relative To	1508
Marker Trace	1509
Couple Markers	1509
All Markers Off	1510
Marker Symbol Value (Remote Command only)	1510
Marker X Axis Value (Remote Command only)	1511
Marker X Axis Position (Remote Command only)	1511
Marker Y Axis Value (Remote Command only)	1512
Backward Compatibility SCPI Commands	1512
Marker Function	1513
Marker To	1514
Mkr -> Despread	1514
Meas	1515

Remote Measurement Functions	1515
Measurement Group of Commands	1516
Current Measurement Query (Remote Command Only)	1518
Limit Test Current Results (Remote Command Only)	1518
Data Query (Remote Command Only)	1518
Calculate/Compress Trace Data Query (Remote Command Only)	1519
Calculate Peaks of Trace Data (Remote Command Only)	1524
Hardware-Accelerated Fast Power Measurement (Remote Command Only)	1525
Reset Fast Power Measurement (Remote Command Only)	1525
Define Fast Power Measurement (Remote Command Only)	1526
Define Fast Power Measurement Query (Remote Command Only)	1535
Configure Fast Power Measurement (Remote Command Only)	1536
Initiate Fast Power Measurement (Remote Command Only)	1537
Fetch Fast Power Measurement (Remote Command Only)	1537
Execute Fast Power Measurement (Remote Command Only)	1537
Binary Read Fast Power Measurement (Remote Command Only)	1538
Diagnostic Binary Read Fast Power Measurement (Remote Command Only)	1538
Format Data: Numeric Data (Remote Command Only)	1539
Format Data: Byte Order (Remote Command Only)	1540
Meas Setup	1541
Meas Type	1541
Walsh Code Length	1541
Walsh Code Number	1542
Meas Interval	1542
Meas Offset	1543
PN Offset	1543
Sync Type(BTS only)	1544
Capture Interval	1544
Spectrum Inversion	1545
Meas Preset	1545
Advanced	1545
Active Threshold	1546
Filter Alpha	1546
Chip Rate	1547
Walsh Code QOF (BTS only)	1547
Mode	1548
Mode Preset	1549
How-To Preset	1550
Mode Setup	1552
Peak Search	1553
Next Peak	1553
Next Pk Right	1553
Next Pk Left	1553

Table of Contents

Marker Delta	1554
Pk-Pk Search	1554
Min Search	1554
Print	1555
Quick Save	1556
Recall	1558
State	1558
More Information	1560
From File...	1560
Edit Register Names	1562
Register 1 thru Register 16	1562
Register 1 thru Register 16	1563
Sequences	1564
Source Sequence	1564
Open...	1565
Data (Import)	1565
Capture Buffer	1566
Open...	1566
Restart	1567
More Information	1567
Save	1569
State	1569
To File . . .	1570
Edit Register Names	1572
More Information	1572
Register 1 thru Register 16	1573
Register 1 thru Register 16	1573
Mass Storage Catalog (Remote Command Only)	1574
Mass Storage Change Directory (Remote Command Only)	1575
Mass Storage Copy (Remote Command Only)	1575
Mass Storage Device Copy (Remote Command Only)	1575
Mass Storage Delete (Remote Command Only)	1576
Mass Storage Data (Remote Command Only)	1576
Mass Storage Make Directory (Remote Command Only)	1576
Mass Storage Move (Remote Command Only)	1576
Mass Storage Remove Directory (Remote Command Only)	1577
Mass Storage Determine Removable Media (Remote Command Only)	1577
Mass Storage Determine Removable Media Label (Remote Command Only)	1578
Mass Storage Determine Removable Media Write-protect status (Remote Command Only)	1578
Mass Storage Determine Removable Media size (Remote Command Only)	1578
Sequences	1579
Source Sequence	1579

Save As . . .	1579
Data (Export)	1580
Measurement Results	1580
Meas Results File Contents	1581
Marker Table	1581
Peak Table	1584
Spectrogram	1587
Capture Buffer	1591
Save As . . .	1592
Screen Image	1593
Themes	1594
3D Color	1594
3D Monochrome	1594
Flat Color	1595
Flat Monochrome	1595
Save As...	1595
Single (Single Measurement/Sweep)	1596
More Information	1596
Source	1597
RF Output	1597
Amplitude	1597
RF Power	1598
RF Power Range	1599
RF Power Range	1599
Set Reference Power	1599
Power Ref	1600
Amptd Offset	1600
Modulation	1601
Frequency	1602
Frequency	1602
Channel	1603
GSM/EDGE Channel Number Ranges	1603
W-CDMA Channel Number Ranges	1604
CDMA 2000 / 1xEVDO Channel Number Ranges	1606
LTE FDD Channel Number Ranges	1608
LTE TDD Channel Number Ranges	1609
TDSCDMA Channel Number Ranges	1610
Radio Setup	1611
Radio Standard	1611
Radio Band Link	1626
Set Reference Frequency	1627
Freq Reference	1628
Freq Offset	1628

Modulation Setup	1629
ARB	1629
ARB	1630
Select Waveform	1630
ARB Setup	1635
Trigger Type	1640
ARB	1643
Trigger Initiate	1645
Waveform Sequences	1645
Waveform Utilities	1653
Marker Utilities	1658
Header Utilities	1663
AM	1664
AM	1664
AM Depth	1665
AM Rate	1665
FM	1665
FM	1666
FM Deviation	1666
FM Rate	1666
PM	1667
PM	1667
PM Deviation	1667
PM Rate	1667
List Sequencer	1668
Sequencer	1668
Initiate Sequence	1669
List Sequencer Setup	1669
Number of Steps	1669
Current Step	1670
Insert Step Before	1670
Delete Step	1670
Clear List	1671
Step Trigger	1671
Transition Time	1673
Radio Setup	1673
Channel	1688
Frequency	1688
Power	1689
Waveform	1689
Step Duration	1695
Output Trigger	1697
Repetition	1697

Single	1697
Continuous	1698
Trigger Type	1698
BeginningOfStep	1698
DataMarker	1699
Manual Trigger Now	1700
Source Preset	1700
SPAN X Scale	1701
Start Code Number	1701
Stop Code Number	1701
Code Span	1702
Start Code Number	1702
Stop Code Number	1703
Sweep/Control	1704
Pause/Resume	1704
System	1705
Trace/Detector	1706
Trigger	1707
Free Run	1707
Video	1707
Trigger Level	1707
Trig Slope	1707
Trig Delay	1707
External 1	1707
Trigger Level	1707
Trig Slope	1707
Trig Delay	1707
Zero Span Delay Comp	1707
External 2	1707
Trigger Level	1707
Trig Slope	1707
Trig Delay	1708
Zero Span Delay Comp	1708
RF Burst	1708
Absolute Trigger	1708
Relative Trigger	1708
Trig Slope	1708
Trig Delay	1708
Periodic Timer	1708
Period	1708
Offset	1708
Offset Adjust (Remote Command Only)	1708
Reset Offset Display	1708

Table of Contents

Sync Source	1708
Off	1708
External 1	1709
External 2	1709
RF Burst	1709
Trig Delay	1709
Auto/Holdoff	1709
Auto Trig	1709
Trig Holdoff	1709
Internal	1709
User Preset	1710
User Preset	1710
User Preset All Modes	1711
Save User Preset	1712
View/Display	1713
View Selection by name (SCPI only)	1713
View Selection by number (SCPI only)	1713
Display	1714
Annotation	1714
Meas Bar On/Off	1715
Screen	1716
Active Function Values On/Off	1716
Title	1717
Change Title	1717
Clear Title	1718
Graticule	1719
System Display Settings	1719
Annotation Local Settings	1719
Themes	1720
Power Graph & Metrics	1721
Radio Device: BTS	1721
CDP(Code Domain Power) Graph window	1722
Numeric Results window	1722
Radio Device: MS	1723
CDP(Code Domain Power) Graph window	1724
Numeric Results window	1724
Code Order	1725
Base Code Length	1725
Consolidated Marker	1726
I/Q Error (Quad View)	1727
Radio Device: BTS	1727
Magnitude Error window	1727
Phase Error window	1728

EVM window	1728
Numeric Results window	1728
Radio Device: MS	1728
Magnitude Error window Note 1	1729
Phase Error window (Note 1, 2)	1729
EVM window Note 1	1729
Numeric Results window	1729
13 Modulation Accuracy (Composite Rho) Measurement	1731
AMPTD Y Scale	1735
Ref Value	1735
I/Q Error View - EVM Window	1735
I/Q Error View - Mag Error Window	1736
I/Q Error View - Phase Error Window	1736
Range	1737
Range	1737
Adjust Range For Min Clip	1737
Pre-Adjust for Min Clip	1738
Peak to Average	1738
Mixer Level Offset	1739
Ref Position	1739
I/Q Error View - EVM Window	1739
I/Q Error View - Mag Error Window	1740
I/Q Error View - Phase Error Window	1740
Auto Scaling	1740
I/Q Error View - EVM Window	1741
I/Q Error View - Mag Error Window	1741
I/Q Error View - Phase Error Window	1742
Auto Couple	1743
More Information	1743
Auto/Man Active Function keys	1743
Auto/Man 1-of-N keys	1743
BW	1745
Cont (Continuous Measurement/Sweep)	1746
File	1748
FREQ Channel	1749
Center Freq	1749
Center Frequency Presets	1750
RF Center Freq	1752
Ext Mix Center Freq	1753
I/Q Center Freq	1754
CF Step	1754
Input/Output	1757
Marker	1758

Select Marker	1758
Properties	1758
Select Marker	1758
Relative To	1758
Marker Trace	1759
Couple Markers	1759
All Markers Off	1760
Marker Chip Value (Remote Command only)	1760
Marker X Axis Value (Remote Command only)	1761
Marker X Axis Position (Remote Command only)	1761
Marker Y Axis Value (Remote Command only)	1762
Meas	1763
Remote Measurement Functions	1763
Measurement Group of Commands	1764
Current Measurement Query (Remote Command Only)	1766
Limit Test Current Results (Remote Command Only)	1766
Data Query (Remote Command Only)	1766
Calculate/Compress Trace Data Query (Remote Command Only)	1767
Calculate Peaks of Trace Data (Remote Command Only)	1772
Hardware-Accelerated Fast Power Measurement (Remote Command Only)	1773
Reset Fast Power Measurement (Remote Command Only)	1773
Define Fast Power Measurement (Remote Command Only)	1774
Define Fast Power Measurement Query (Remote Command Only)	1783
Configure Fast Power Measurement (Remote Command Only)	1784
Initiate Fast Power Measurement (Remote Command Only)	1785
Fetch Fast Power Measurement (Remote Command Only)	1785
Execute Fast Power Measurement (Remote Command Only)	1785
Binary Read Fast Power Measurement (Remote Command Only)	1786
Diagnostic Binary Read Fast Power Measurement (Remote Command Only)	1786
Format Data: Numeric Data (Remote Command Only)	1787
Format Data: Byte Order (Remote Command Only)	1788
Meas Setup	1789
Avg Number	1789
Avg Mode	1789
Limits	1790
RMS EVM (Composite)	1790
Peak EVM (Composite)	1791
Rho (Composite)	1791
Peak Code Domain Error	1792
Timing Error	1792
Phase Error	1793
PN Offset	1793
Sync Type BTS	1794

Spectrum	1794
Advanced	1795
EVM Result I/Q Offset	1795
Active Threshold	1796
Filter Alpha	1796
Chip Rate	1797
Multi Channel Estimator	1797
Meas Preset	1797
Mode	1799
Mode Preset	1800
How-To Preset	1801
Mode Setup	1803
Peak Search	1804
Next Peak	1804
Next Pk Right	1804
Next Pk Left	1804
Marker Delta	1805
Pk-Pk Search	1805
Min Search	1805
Print	1806
Quick Save	1807
Recall	1809
State	1809
More Information	1811
From File...	1811
Edit Register Names	1813
Register 1 thru Register 16	1813
Register 1 thru Register 16	1814
Sequences	1815
Source Sequence	1815
Open...	1816
Data (Import)	1816
Capture Buffer	1817
Open...	1817
Restart	1818
More Information	1818
Save	1820
State	1820
To File . . .	1821
Edit Register Names	1823
More Information	1823
Register 1 thru Register 16	1824
Register 1 thru Register 16	1824

Mass Storage Catalog (Remote Command Only)	1825
Mass Storage Change Directory (Remote Command Only)	1826
Mass Storage Copy (Remote Command Only)	1826
Mass Storage Device Copy (Remote Command Only)	1826
Mass Storage Delete (Remote Command Only)	1827
Mass Storage Data (Remote Command Only)	1827
Mass Storage Make Directory (Remote Command Only)	1827
Mass Storage Move (Remote Command Only)	1827
Mass Storage Remove Directory (Remote Command Only)	1828
Mass Storage Determine Removable Media (Remote Command Only)	1828
Mass Storage Determine Removable Media Label (Remote Command Only)	1829
Mass Storage Determine Removable Media Write-protect status (Remote Command Only)	1829
Mass Storage Determine Removable Media size (Remote Command Only)	1829
Sequences	1830
Source Sequence	1830
Save As . . .	1830
Data (Export)	1831
Measurement Results	1831
Meas Results File Contents	1832
Marker Table	1832
Peak Table	1835
Spectrogram	1838
Capture Buffer	1842
Save As . . .	1843
Screen Image	1844
Themes	1845
3D Color	1845
3D Monochrome	1845
Flat Color	1846
Flat Monochrome	1846
Save As...	1846
Single (Single Measurement/Sweep)	1847
More Information	1847
Source	1848
RF Output	1848
Amplitude	1848
RF Power	1849
RF Power Range	1850
RF Power Range	1850
Set Reference Power	1850
Power Ref	1851
Amptd Offset	1851

Modulation	1852
Frequency	1853
Frequency	1853
Channel	1854
GSM/EDGE Channel Number Ranges	1854
W-CDMA Channel Number Ranges	1855
CDMA 2000 / 1xEVDO Channel Number Ranges	1857
LTE FDD Channel Number Ranges	1859
LTE TDD Channel Number Ranges	1860
TDSCDMA Channel Number Ranges	1861
Radio Setup	1862
Radio Standard	1862
Radio Band Link	1877
Set Reference Frequency	1878
Freq Reference	1879
Freq Offset	1879
Modulation Setup	1880
ARB	1880
ARB	1881
Select Waveform	1881
ARB Setup	1886
Trigger Type	1891
ARB	1894
Trigger Initiate	1896
Waveform Sequences	1896
Waveform Utilities	1904
Marker Utilities	1909
Header Utilities	1914
AM	1915
AM	1915
AM Depth	1916
AM Rate	1916
FM	1916
FM	1917
FM Deviation	1917
FM Rate	1917
PM	1918
PM	1918
PM Deviation	1918
PM Rate	1918
List Sequencer	1919
Sequencer	1919
Initiate Sequence	1920

List Sequencer Setup	1920
Number of Steps	1920
Current Step	1921
Insert Step Before	1921
Delete Step	1921
Clear List	1922
Step Trigger	1922
Transition Time	1924
Radio Setup	1924
Channel	1939
Frequency	1939
Power	1940
Waveform	1940
Step Duration	1946
Output Trigger	1948
Repetition	1948
Single	1948
Continuous	1949
Trigger Type	1949
BeginningOfStep	1949
DataMarker	1950
Manual Trigger Now	1951
Source Preset	1951
SPAN X Scale	1952
Sweep/Control	1953
Pause/Resume	1953
System	1954
Trace/Detector	1955
Trigger	1956
Free Run	1956
Video	1956
Trigger Level	1956
Trig Slope	1956
Trig Delay	1956
External 1	1956
Trigger Level	1956
Trig Slope	1956
Trig Delay	1956
Zero Span Delay Comp	1956
External 2	1956
Trigger Level	1956
Trig Slope	1956
Trig Delay	1957

Zero Span Delay Comp	1957
RF Burst	1957
Absolute Trigger	1957
Relative Trigger	1957
Trig Slope	1957
Trig Delay	1957
Periodic Timer	1957
Period	1957
Offset	1957
Offset Adjust (Remote Command Only)	1957
Reset Offset Display	1957
Sync Source	1957
Off	1957
External 1	1958
External 2	1958
RF Burst	1958
Trig Delay	1958
Auto/Holdoff	1958
Auto Trig	1958
Trig Holdoff	1958
Internal	1958
User Preset	1959
User Preset	1959
User Preset All Modes	1960
Save User Preset	1961
View/Display	1962
View Selection by name (SCPI only)	1962
View Selection by number (SCPI only)	1963
Display	1963
Annotation	1964
Meas Bar On/Off	1965
Screen	1965
Active Function Values On/Off	1965
Title	1966
Change Title	1966
Clear Title	1967
Graticule	1968
System Display Settings	1968
Annotation Local Settings	1968
Themes	1969
I/Q Measured Polar Graph	1970
I/Q Measured Polar Graph view for Radio Device: BTS	1970
I/Q Measured Polar Vector window (Note 1)	1971

Numeric Results window (Note 1)	1971
I/Q Measured Polar Graph view for Radio Device: MS	1972
I/Q Measured Polar Vector window (Note 1)	1973
Numeric Results window (Note 1)	1973
I/Q Polar Vec/ConstIn	1974
Chip Offset	1975
I/Q Chips	1975
+45° Rotation	1976
Full Vector	1976
I/Q Error	1976
I/Q Error view for Radio Device: BTS	1977
EVM window	1977
Magnitude Error window	1977
Phase Error window	1978
I/Q Error view for Radio Device: MS	1978
EVM window	1978
Magnitude Error window	1979
Phase Error window	1979
Power Timing & Phase	1979
Power, Timing, and Phase view for Radio Device: BTS	1979
Power, Timing and Phase view for Radio Device: MS	1980
Prev Page	1981
Next Page	1981
Scroll Up	1982
Scroll Down	1982
First Page	1982
Last Page	1982
14 QPSK EVM Measurement	1983
AMPTD Y Scale	1987
Range	1987
Range	1987
Adjust Range For Min Clip	1987
Pre-Adjust for Min Clip	1988
Peak to Average	1988
Mixer Level Offset	1989
Presel Center	1989
Presel Adjust	1989
Auto Couple	1991
More Information	1991
Auto/Man Active Function keys	1991
Auto/Man 1-of-N keys	1991
BW	1993
Info BW	1993

Info BW Control	1993
Filter Type	1994
Cont (Continuous Measurement/Sweep)	1995
File	1997
FREQ Channel	1998
Center Freq	1998
Center Frequency Presets	1999
RF Center Freq	2001
Ext Mix Center Freq	2002
I/Q Center Freq	2003
CF Step	2003
Input/Output	2006
Marker	2007
Select Marker	2007
Marker Type	2007
Marker Properties	2008
Select Marker	2008
Relative To	2008
Marker Trace	2009
Couple Marker	2009
All Markers Off	2010
Marker X Axis Value (Remote Command only)	2010
Marker Chip Value (Remote Command only)	2011
Marker X Axis Position (Remote Command only)	2011
Marker Y Axis Value (Query Only)	2012
Marker Function	2013
Marker To	2014
Meas	2015
Remote Measurement Functions	2015
Measurement Group of Commands	2016
Current Measurement Query (Remote Command Only)	2018
Limit Test Current Results (Remote Command Only)	2018
Data Query (Remote Command Only)	2018
Calculate/Compress Trace Data Query (Remote Command Only)	2019
Calculate Peaks of Trace Data (Remote Command Only)	2024
Hardware-Accelerated Fast Power Measurement (Remote Command Only)	2025
Reset Fast Power Measurement (Remote Command Only)	2025
Define Fast Power Measurement (Remote Command Only)	2026
Define Fast Power Measurement Query (Remote Command Only)	2035
Configure Fast Power Measurement (Remote Command Only)	2036
Initiate Fast Power Measurement (Remote Command Only)	2037
Fetch Fast Power Measurement (Remote Command Only)	2037
Execute Fast Power Measurement (Remote Command Only)	2037

Table of Contents

Binary Read Fast Power Measurement (Remote Command Only)	2038
Diagnostic Binary Read Fast Power Measurement (Remote Command Only)	2038
Format Data: Numeric Data (Remote Command Only)	2039
Format Data: Byte Order (Remote Command Only)	2040
Meas Setup	2041
Avg/Hold Number	2041
Avg Mode	2041
Meas Interval	2042
Limits	2042
RMS EVM	2043
Freq Error	2043
Spectrum	2044
Meas Preset	2044
Advanced	2044
EVM Result I/Q Offset	2045
Chip Rate	2045
Mode	2047
Mode Preset	2048
How-To Preset	2049
Mode Setup	2051
Peak Search	2052
Next Peak	2052
Next Pk Right	2052
Next Pk Left	2053
Marker Delta	2053
Pk-Pk Search	2053
Min Search	2053
Print	2055
Quick Save	2056
Recall	2058
State	2058
More Information	2060
From File...	2060
Edit Register Names	2062
Register 1 thru Register 16	2062
Register 1 thru Register 16	2063
Sequences	2064
Source Sequence	2064
Open...	2065
Data (Import)	2065
Capture Buffer	2066
Open...	2066
Restart	2067

More Information	2067
Save	2069
State	2069
To File . . .	2070
Edit Register Names	2072
More Information	2072
Register 1 thru Register 16	2073
Register 1 thru Register 16	2073
Mass Storage Catalog (Remote Command Only)	2074
Mass Storage Change Directory (Remote Command Only)	2075
Mass Storage Copy (Remote Command Only)	2075
Mass Storage Device Copy (Remote Command Only)	2075
Mass Storage Delete (Remote Command Only)	2076
Mass Storage Data (Remote Command Only)	2076
Mass Storage Make Directory (Remote Command Only)	2076
Mass Storage Move (Remote Command Only)	2076
Mass Storage Remove Directory (Remote Command Only)	2077
Mass Storage Determine Removable Media (Remote Command Only)	2077
Mass Storage Determine Removable Media Label (Remote Command Only)	2078
Mass Storage Determine Removable Media Write-protect status (Remote Command Only)	2078
Mass Storage Determine Removable Media size (Remote Command Only)	2078
Sequences	2079
Source Sequence	2079
Save As . . .	2079
Data (Export)	2080
Measurement Results	2080
Meas Results File Contents	2081
Marker Table	2081
Peak Table	2084
Spectrogram	2087
Capture Buffer	2091
Save As . . .	2092
Screen Image	2093
Themes	2094
3D Color	2094
3D Monochrome	2094
Flat Color	2095
Flat Monochrome	2095
Save As...	2095
Single (Single Measurement/Sweep)	2096
More Information	2096
Source	2097

Table of Contents

RF Output	2097
Amplitude	2097
RF Power	2098
RF Power Range	2099
RF Power Range	2099
Set Reference Power	2099
Power Ref	2100
Amptd Offset	2100
Modulation	2101
Frequency	2102
Frequency	2102
Channel	2103
GSM/EDGE Channel Number Ranges	2103
W-CDMA Channel Number Ranges	2104
CDMA 2000 / 1xEVDO Channel Number Ranges	2106
LTE FDD Channel Number Ranges	2108
LTE TDD Channel Number Ranges	2109
TDSCDMA Channel Number Ranges	2110
Radio Setup	2111
Radio Standard	2111
Radio Band Link	2126
Set Reference Frequency	2127
Freq Reference	2128
Freq Offset	2128
Modulation Setup	2129
ARB	2129
ARB	2130
Select Waveform	2130
ARB Setup	2135
Trigger Type	2140
ARB	2143
Trigger Initiate	2145
Waveform Sequences	2145
Waveform Utilities	2153
Marker Utilities	2158
Header Utilities	2163
AM	2164
AM	2164
AM Depth	2165
AM Rate	2165
FM	2165
FM	2166
FM Deviation	2166

FM Rate	2166
PM	2167
PM	2167
PM Deviation	2167
PM Rate	2167
List Sequencer	2168
Sequencer	2168
Initiate Sequence	2169
List Sequencer Setup	2169
Number of Steps	2169
Current Step	2170
Insert Step Before	2170
Delete Step	2170
Clear List	2171
Step Trigger	2171
Transition Time	2173
Radio Setup	2173
Channel	2188
Frequency	2188
Power	2189
Waveform	2189
Step Duration	2195
Output Trigger	2197
Repetition	2197
Single	2197
Continuous	2198
Trigger Type	2198
BeginningOfStep	2198
DataMarker	2199
Manual Trigger Now	2200
Source Preset	2200
SPAN X Scale	2201
Sweep/Control	2202
Pause	2202
System	2203
Trace/Detector	2204
Trigger	2205
Free Run	2205
Video	2205
Trigger Level	2205
Trig Slope	2205
Trig Delay	2205
External 1	2205

Table of Contents

Trigger Level	2205
Trig Slope	2205
Trig Delay	2205
Zero Span Delay Comp	2205
External 2	2205
Trigger Level	2205
Trig Slope	2205
Trig Delay	2206
Zero Span Delay Comp	2206
RF Burst	2206
Absolute Trigger	2206
Relative Trigger	2206
Trig Slope	2206
Trig Delay	2206
Periodic Timer	2206
Period	2206
Offset	2206
Offset Adjust (Remote Command Only)	2206
Reset Offset Display	2206
Sync Source	2206
Off	2206
External 1	2207
External 2	2207
RF Burst	2207
Trig Delay	2207
Auto/Holdoff	2207
Auto Trig	2207
Trig Holdoff	2207
Internal	2207
User Preset	2208
User Preset	2208
User Preset All Modes	2209
Save User Preset	2210
View/Display	2211
View Selection by name (Remote Command Only)	2211
View Selection by number (Remote Command only)	2211
Display	2212
Annotation	2212
Meas Bar On/Off	2213
Screen	2214
Active Function Values On/Off	2214
Title	2215
Change Title	2215

Clear Title	2216
Graticule	2217
System Display Settings	2217
Annotation Local Settings	2217
Themes	2218
I/Q Polar Vec/Constln	2219
Chip Offset	2220
I/Q Chips	2220
Interpolation	2221
+45° Rotation	2221
Full Vector	2222
I/Q Error View	2222
Mag Error vs. Symbol Window	2223
Phase Error vs. Symbol Window	2223
EVM vs. Symbol Window	2223
Numeric Results Window	2224

1 About the Transceiver

The M9420A VXT Vector Transceiver measures and monitors complex RF and microwave signals. The transceiver integrates traditional measurements with advanced vector signal analysis to optimize speed, accuracy, and dynamic range.

With a broad set of applications and demodulation capabilities, an intuitive virtual user interface, outstanding connectivity and powerful measurements, the transceiver is ideal for both R&D and manufacturing engineers working on cellular, emerging wireless communications, general purpose, aerospace and defense applications.

Installing Application Software

If you want to install a measurement application after your initial hardware purchase, you need only to license it. When you purchase a new application, you will receive an entitlement certificate that you can use to obtain a license key for that application. To activate the new measurement application, enter the license key that you obtain into the Signal Transceiver.

Viewing a License Key

Measurement applications that you purchased with your instrument have been installed and activated at the factory before shipment. The instrument requires a unique License Key for every measurement application purchased. The license key is a hexadecimal string that is specific to your measurement application, instrument model number and serial number. It enables you to install, or reactivate, that particular application.

Press **System, Show, System** in virtual panel to display the measurement applications that are currently licensed in your transceiver.

Go to the following location to view the license keys for the installed measurement applications:

C:\Program Files\Keysight\Licensing

You may want to keep a copy of your license key in a secure location. To do this, you can print out a copy of the display showing the license numbers. If you should lose your license key, call your nearest Keysight Technologies service or sales office for assistance.

Obtaining and Installing a License Key

If you purchase an additional application that requires installation, you will receive an "Entitlement Certificate", which may be redeemed for a license key for one instrument. To obtain your license key, follow the instructions that accompany the certificate.

Installing a license key for the selected application can be done automatically using a USB memory device. To do this, you copy the license file to the USB memory device, at the root level. Follow the instructions that come with your software installation kit.

Installing a license key can also be done manually using the built-in license management application, which may be found via the virtual front panel keys at **System, Licensing. . .**, or on-disk at:

C:\Programming Files\Keysight\Licensing

You can also use these procedures to reinstall a license key that has been accidentally deleted, or lost due to a memory failure.

Updating Measurement Application Software

All the software applications were loaded at the time of original instrument manufacture. It is a good idea to regularly update your software with the latest available version. This helps to ensure that you receive any improvements and expanded functionality.

Because the software was loaded at the initial purchase, further additional measurement applications may now be available. If the application you are interested in licensing is not available, you will need to do a software update. (To display a list of installed applications, press **System, Show, System** in virtual panel.)

Check the appropriate page of the Keysight web site for the latest available software versions as follows:

<http://www.keysight.com/find/m9420a>

You can load the updated software package into the analyzer from a USB drive, or directly from Internet. An automatic loading program is included with the files.

M9420A Options and Accessories

You can view an online list of available Options and Accessories for your instrument as follows:

1. Browse to one of the following URLs, according to the product name of your analyzer:
www.keysight.com/find/m9420a
2. The home page for Keysight M9420A VXT Vector Transceiver appears (in some cases, you may see an initial splash screen containing a button named View the Webpage, which you should click to display the home page).
3. Click the Options tab, to display a list of available options and accessories for your instrument.

Virtual Front-Panel Features

The instrument's Virtual Front-panel features are fully detailed in the section "Virtual Front-Panel Features" of the M9420A Getting Started Guide.

Display Annotations

Display Annotations are fully detailed under the Section "Display Annotations" of the M9420A Getting Started Guide.

Window Control Keys

The instrument provides three virtual-front-panel keys or four menu items for controlling windows.

Virtual Front Panel

The virtual-front-panel keys are Multi Window, Zoom, and Next Window. These are all “immediate action” keys.



Windows Control Menu

The menu items are Zoom, Split Screen, Next [Window], and Full screen. These are all “immediate action” menu selections. Zoom and Full Screen are toggle functions.

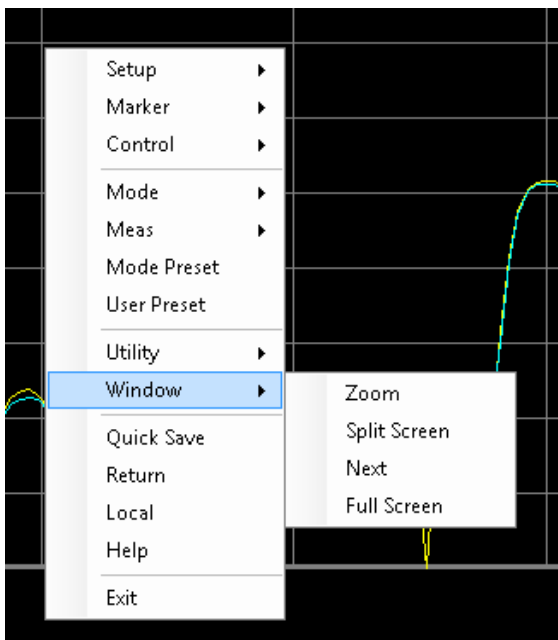

Multi-Window

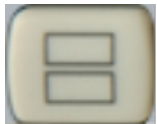

The Multi Window front-panel key will toggle you back and forth between the Normal View and the last Multi Window View (Zone Span, Trace Zoom or Spectrogram) that you were in, when using the Swept SA measurement of the Spectrum Analyzer Mode. It remembers which View you were in through a Preset. This “previous view” is set to Zone Span on a Restore Mode Defaults.

Key Path	Front-panel key
Initial S/W Revision	Prior to A.02.00

Zoom

Zoom is a toggle function. Pressing this key once increases the size of the selected window. Pressing the key again returns the window to the original size.

When Zoom is on for a window, that window will get the entire primary display area. The zoomed window, since it is the selected window, is outlined in green.

Zoom is local to each Measurement. Each Measurement remembers its Zoom state. The Zoom state of each Measurement is part of the Mode’s state.

NOTE

Data acquisition and processing for the other windows continues while a window is zoomed, as does all SCPI communication with the other windows.

Remote Command	:DISPlay:WINDow:FORMat:ZOOM
Remote Command	:DISPlay:WINDow:FORMat:TILE
Example	:DISP:WIND:FORM:ZOOM sets zoomed :DISP:WIND:FORM:TILE sets un-zoomed
Preset	TILE
Initial S/W Revision	Prior to A.02.00

Next Window

Selects the next window of the current view. When the Next Window key is pressed, the next window in the order of precedence becomes selected. If the selected window was zoomed, the next window will also be zoomed.

The window numbers are as follows. Note that these numbers also determine the order of precedence (that is, Next Window goes from 1 to 2, then 2 to 3, etc.):

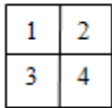

Four window display

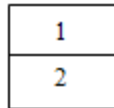

Two window display

RTSA measurements:

Only two windows are available in the Spectrogram view under the Spectrum measurement and up to three windows are available in the Power vs. Time measurement, depending on the view set up.

Remote Command	:DISPlay:WINDow[:SElect] <number> :DISPlay:WINDow[:SElect]?
Example	:DISP:WIND 1
Preset	1
Min	1
Max	If <number> is greater than the number of windows, limit to <number of windows>
Initial S/W Revision	Prior to A.02.00

One and only one window is always selected. The selected window has the focus; this means that all window-specific key presses apply only to that window. You can tell which window is selected by the thick green border around it. If a window is not selected, its boundary is gray.

If a window in a multi-window display is zoomed it is still outlined in green. If there is only one window, the green outline is not used. This allows the user to distinguish between a zoomed window and a display with only one window.

The selected window is local to each Measurement. Each Measurement remembers which window is selected. The selected window for each Measurement is remembered in Mode state.

NOTE

When this key is pressed in Help Mode, it toggles focus between the table of contents window and the topic pane window.

Full Screen

When Full Screen is pressed the measurement window expands horizontally over the entire instrument display. The screen graticule area expands to fill the available display area.

It turns off the display of the softkey labels, however the menus and active functions still work. (Though it would obviously be very hard to navigate without the key labels displayed.) Pressing Full Screen again while Full Screen is in effect cancels Full Screen.

Note that the banner and status lines are unaffected. You can get even more screen area for your data display by turning off the Meas Bar (in the Display menu) which also turns off the settings panel.

Full Screen is a Meas Global function. Therefore it is cancelled by the Preset key.

Key Path	Display
Remote Command	:DISPlay:FSCReen[:STATe] OFF ON 0 1 :DISPlay:FSCReen[:STATe]?
Preset	Unaffected by Preset but set to Off by Restore Misc Defaults or shutdown and restart
State Saved	Not saved in instrument state.
Backwards Compatibility SCPI	:DISPlay:MENU[:STATe] OFF ON 0 1 This emulates ESA full screen functionality, which is the same as the FSCReen command in PSA except that the sense of on/off is reversed (that is, OFF means the menus are OFF, so Fullscreen is ON) and the default is ON (meaning Fullscreen is OFF).
Backwards Compatibility Notes	In ESA/PSA, Full Screen was turned on with a softkey, so pressing any other key turned Full Screen off. In the X-Series, because a hardkey is provided to turn this function on and off, pressing any other key no longer turns off Full Screen
Initial S/W Revision	Prior to A.02.00

Display Enable (Remote Command Only)

Turns the display on/off, including the display drive circuitry. The backlight stays lit so you can tell that the instrument is on. The display enable setting is mode global. The reasons for turning the display off are three:

- To increase speed as much as possible by freeing the instrument from having to update the display
- To reduce emissions from the display, drive circuitry
- For security purposes

If you have turned off the display:

- and you are in local operation, the display can be turned back on by pressing any key or by sending the SYSTem:DEFaults MISC command or the DISPlay:ENABle ON (neither *RST nor SYSTem:PRESet enable the display.)
- and you are in remote operation, the display can be turned back on by pressing the Local or Esc keys or by sending the SYSTem:DEFaults MISC command or the DISPlay:ENABle ON (neither *RST nor SYSTem:PRESet enable the display.)

and you are using either the SYSTem:KLOCK command or GPIB local lockout, then no front-panel key press will turn the display back on. You must turn it back on remotely.

Remote Command	:DISPlay:ENABle OFF ON 0 1 :DISPlay:ENABle?
Example	DISP:ENAB OFF
Couplings	DISP:ENAB OFF turns Backlight OFF and DISP:ENAB ON turns Backlight ON. However, settings of Backlight do not change the state of DISP:ENAB
Preset	On Set by SYST:DEF MISC, but Not affected by *RST or SYSTem:PRESet.

State Saved	Not saved in instrument state.
Backwards Compatibility Notes	SYST:PRES no longer turns on DISPlay:ENABle as it did in legacy analyzers
Initial S/W Revision	Prior to A.02.00

Mouse and Keyboard Control

If you do not have access to the instrument front-panel, there are several ways that a mouse and PC Keyboard can give you access to functions normally accessed using the front-panel keys.

For instrument lacking a physical front panel display, you can watch the instrument display via external monitor or remote desktop connection

Right-Click

If you plug in a mouse and right-click on the analyzer screen, a menu will appear as below:

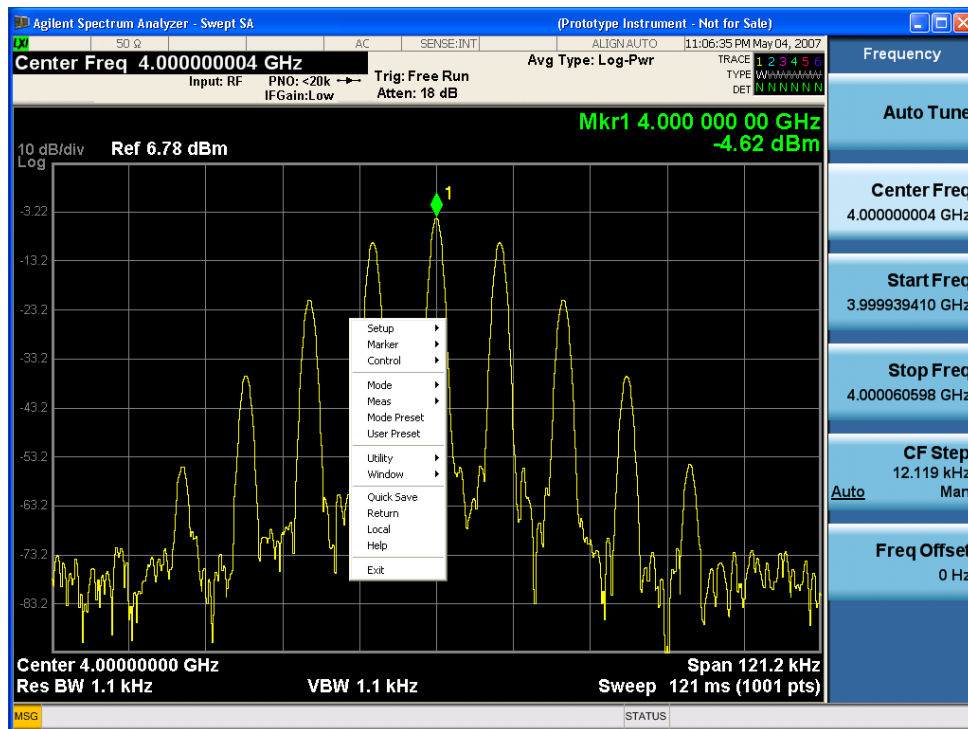

Placing the mouse on one of the rows marked with a right arrow symbol will cause that row to expand, as for example below where the mouse is hovered over the “Utility” row:

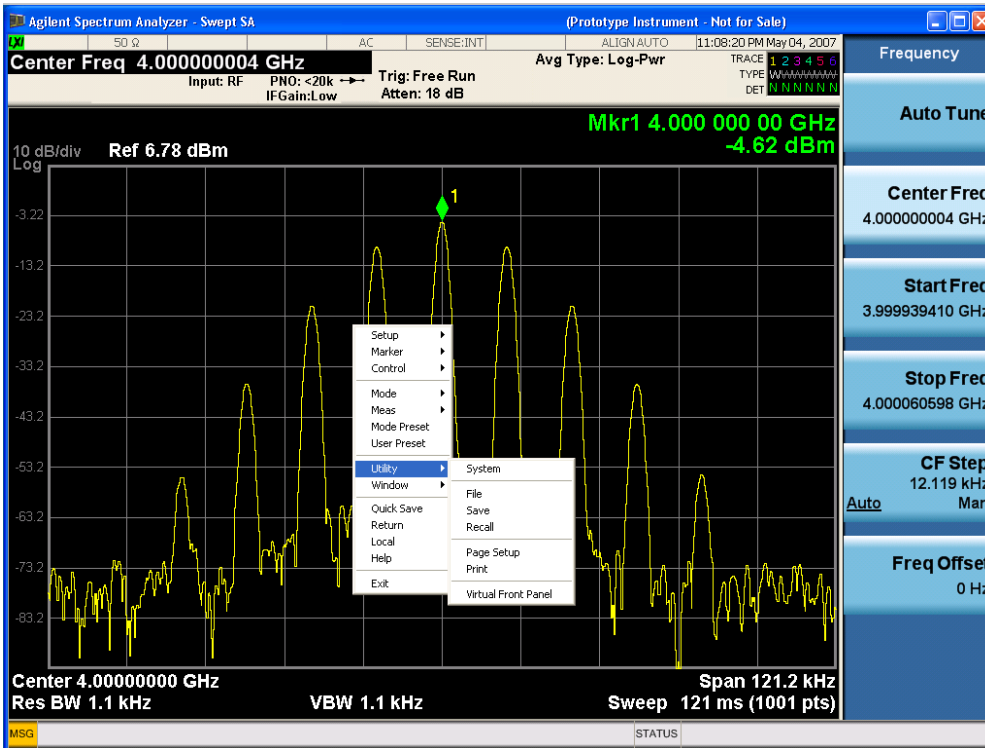

This method can be used to access any of the front-panel keys by using a mouse; as for example if you are accessing the instrument through Remote Desktop.

The array of keys thus available is shown below:

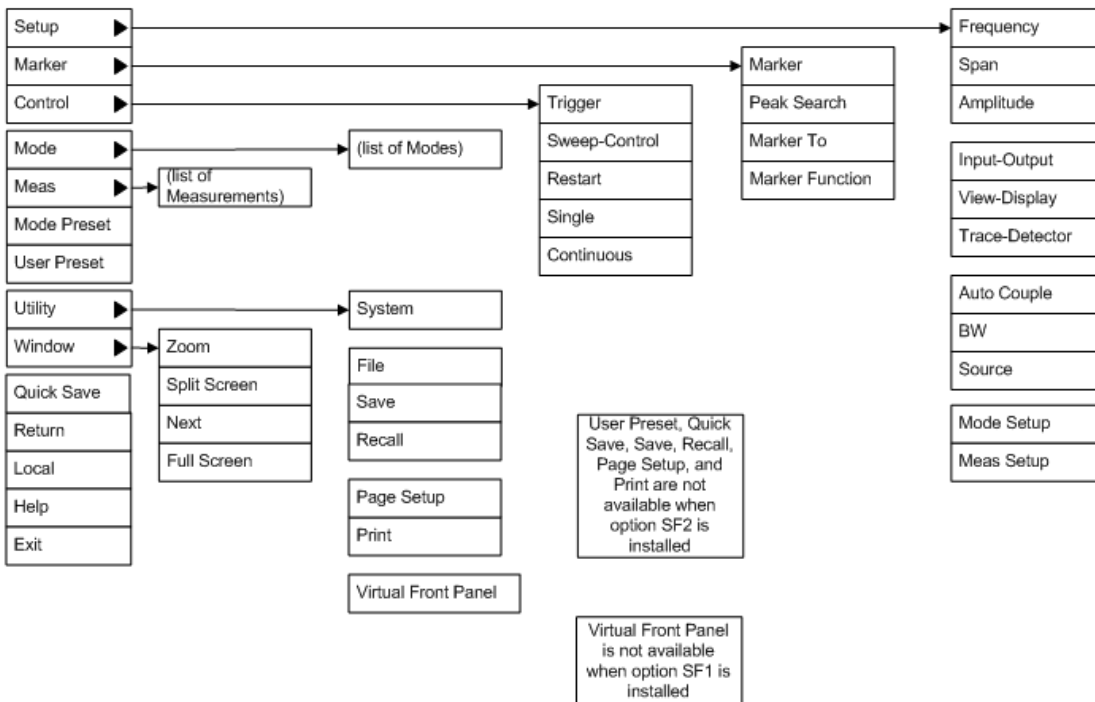

PC Keyboard

If you have a PC keyboard plugged in (or via Remote Desktop), certain key codes on the PC keyboard map to front-panel keys on the GPSA front panel. These key codes are shown below:

Front-panel key	Key code
Frequency	CTRL+SHIFT+F
Span	CTRL+SHIFT+S
Amplitude	CTRL+SHIFT+A
Input/Output	CTRL+SHIFT+O
View/Display	CTRL+SHIFT+V
Trace/Detector	CTRL+ALT+T
Auto Couple	CTRL+SHIFT+C
Bandwidth	CTRL+ALT+B
Source	CTRL+ALT-U
Marker	CTRL+ALT+K
Peak Search	CTRL+ALT+P
Marker To	CTRL+ALT+N
Marker Function	CTRL+ALT+F
System	CTRL+SHIFT+Y
Quick Save	CTRL+Q
Save	CTRL+S
Recall	CTRL+R
Mode Preset	CTRL+M
User Preset	CTRL+U
Print	CTRL+P
File	CTRL+SHIFT+L
Mode	CTRL+SHIFT+M
Measure	CTRL+ALT+M
Mode Setup	CTRL+SHIFT+E
Meas Setup	CTRL+ALT+E
Trigger	CTRL+SHIFT+T
Sweep/Control	CTRL+SHIFT+W
Restart	CTRL+ALT+R
Single	CTRL+ALT+S
Cont	CTRL+ALT+C
Zoom	CTRL+SHIFT+Z
Next Window	CTRL+SHIFT+N
Split Screen	CTRL+L

Front-panel key	Key code
Full Screen	CTRL+SHIFT+B
Return	CTRL+SHIFT+R
Mute	Mute
Inc Audio	Volume Up
Dec Audio	Volume Down
Help	F1
Control	CTRL
Alt	ALT
Enter	Return
Cancel	Esc
Del	Delete
Backspace	Backspace
Select	Space
Up Arrow	Up
Down Arrow	Down
Left Arrow	Left
Right Arrow	Right
Menu key 1	CTRL+SHIFT+F1
Menu key 2	CTRL+SHIFT+F2
Menu key 3	CTRL+SHIFT+F3
Menu key 4	CTRL+SHIFT+F4
Menu key 5	CTRL+SHIFT+F5
Menu key 6	CTRL+SHIFT+F6
Menu key 7	CTRL+SHIFT+F7
Backspace	BACKSPACE
Enter	ENTER
Tab	Tab
1	1
2	2
3	3
4	4
5	5
6	6
7	7
8	8
9	9
0	0

1 About the Transceiver
 Mouse and Keyboard Control

This is a pictorial view of the table:

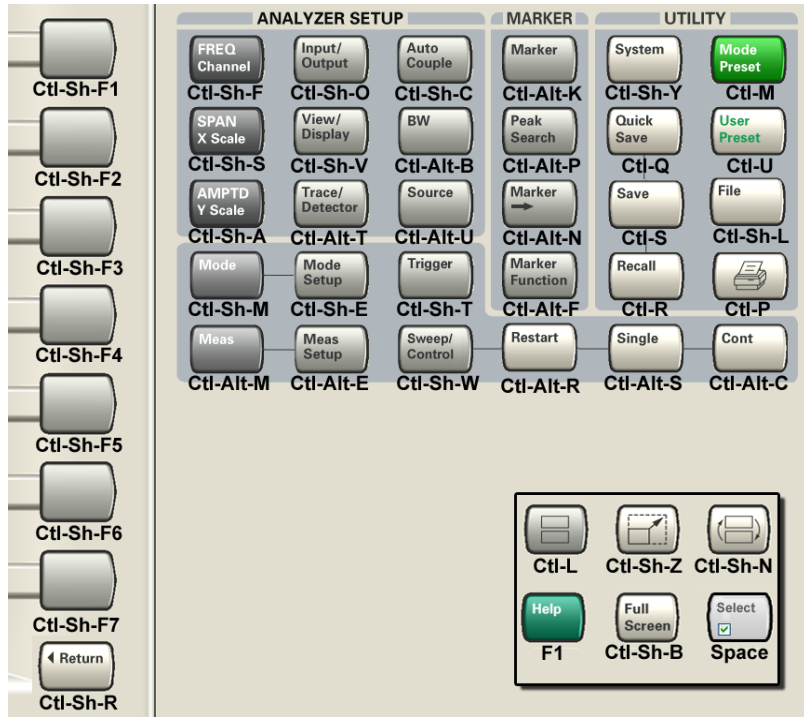

2 About the cdma2000 Measurement Application

This chapter provides overall information on cdma2000 communications systems, and describes cdma2000 measurements made by the analyzer.

What Does the cdma2000 Application Do?

This analyzer can be used for testing a cdma2000 transmitter and IS95 signals with the Radio configuration 1 and 2. It is manufactured according to the following standards documents:

- 3GPP2 C.S0002 Physical Layer Standard for cdma2000 Spread Spectrum Systems
- 3GPP2 C. S0010 Recommended Minimum Performance Standards for cdma2000 Spread Spectrum Base Stations
- 3GPP2 C. S0011 Recommended Minimum Performance Standards for cdma2000 Spread Spectrum Mobile Stations

These documents define complex, multi-part measurements used to create and maintain an interference-free environment. For example, the documents include standardized test methods for the measurement of power in a carrier, a spectrum emission mask, and other critical measurements.

The instrument automatically makes these measurements using the measurement methods and limits defined in the documents. The detailed results displayed by the measurements enable you to analyze cdma2000 system performance. You may alter the measurement parameters for specialized analysis. For infrastructure test, the analyzer tests transmitters of base stations in a non-interfering manner, using a coupler or power splitter.

This analyzer makes the following measurements of cdma2000 signals:

- Channel Power
- Adjacent Channel Power (ACP)
- Spectrum Emission Mask
- Occupied BW
- Code Domain
- Modulation Accuracy (Composite RHO)
- QPSK EVM

3 Programming the Transceiver

This section provides introductory information about the programming documentation included with your product.

- ["What Programming Information is Available?" on page 84](#)
- ["STATus Subsystem " on page 85](#)
- ["IEEE 488.2 Common Commands" on page 127](#)

What Programming Information is Available?

The M9420A Documentation can be accessed through the Additional Documentation page in the instrument Help system and is included on the Documentation DVD shipped with the instrument. It can also be found online at: http://www.keysight.com/find/m9420a_manuals.

The following resources are available to help you create programs for automating your unit:

Resource	Description
M9420A Programmer's Guide	Provides general SCPI programming information on the following topics: <ul style="list-style-type: none">• Programming the X-Series Applications• Programming fundamentals• Programming with IVI driver Note that SCPI command descriptions for measurement applications are not in this book, but are in the User's and Programmer's Reference.
User's and Programmer's Reference manuals	Describes all virtual front panel keys, including SCPI commands for a measurement application. Note that: <ul style="list-style-type: none">• Each measurement application has its own User's and Programmer's Reference.• The content in this manual is duplicated in the instrument's Help (the Help that you see for a key is identical to what you see in this manual).
Embedded Help in your instrument	Describes all virtual front panel keys and softkeys, including SCPI commands, for a measurement application. Note that the content that you see in Help when you press a key is identical to what you see in the User's and Programmer's Reference.
M9420A Getting Started Guide	Provides valuable sections related to programming including: <ul style="list-style-type: none">• Licensing New Measurement Application Software - After Initial Purchase• Using the controller to connect to the transceiver This printed document is shipped with the instrument.

STATus Subsystem

The following diagram provides a graphical overview of the entire X-Series Status Register System.

For readability, the diagram is split into two sections:

- ["X-Series Status Register System \(1\) " on page 86](#)
- ["X-Series Status Register System \(2\) " on page 87](#)

X-Series Status Register System (1)

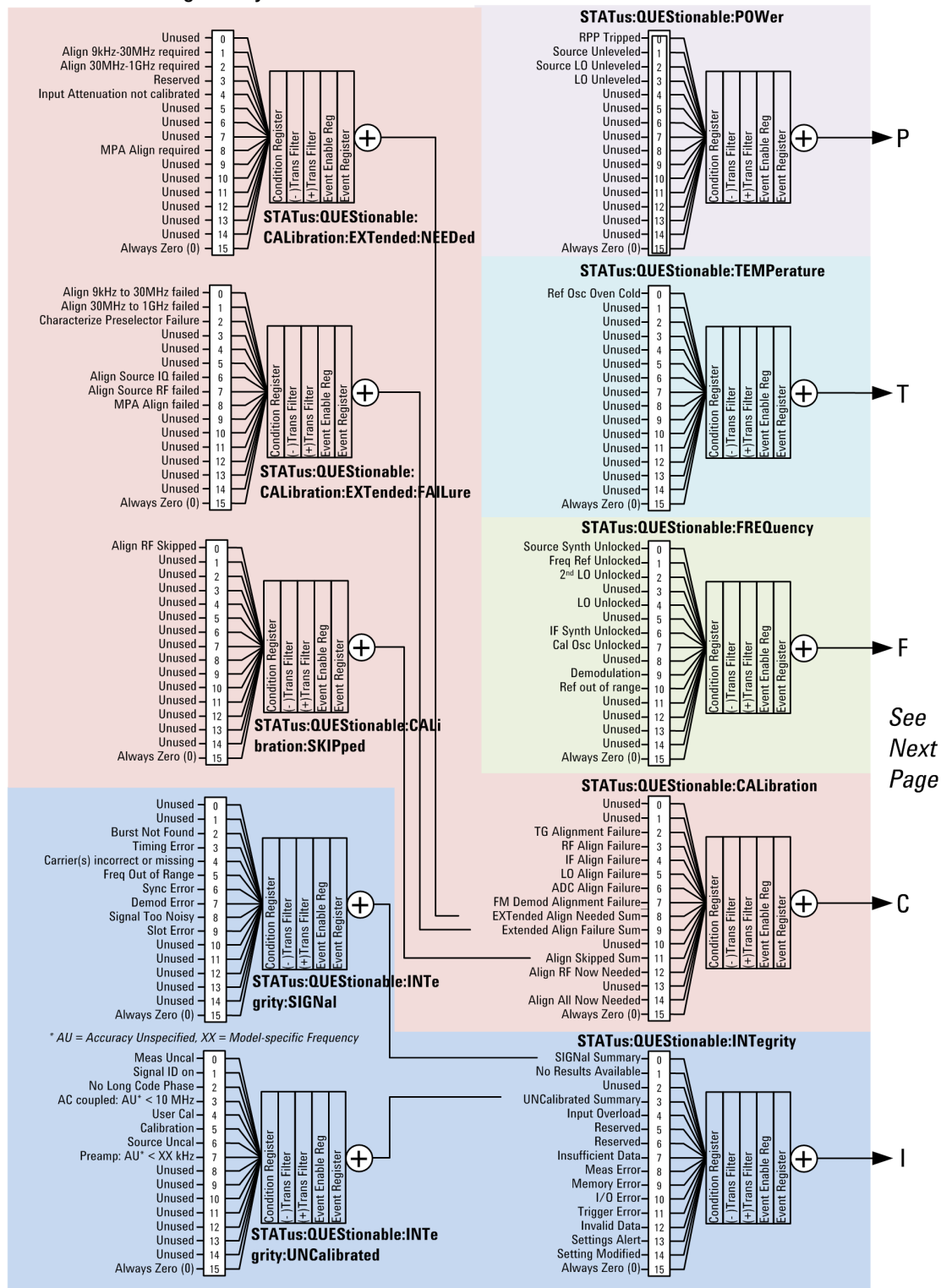

See Next Page

X-Series Status Register System (2)

See
 Previous
 Page

P
 T
 F
 C
 I

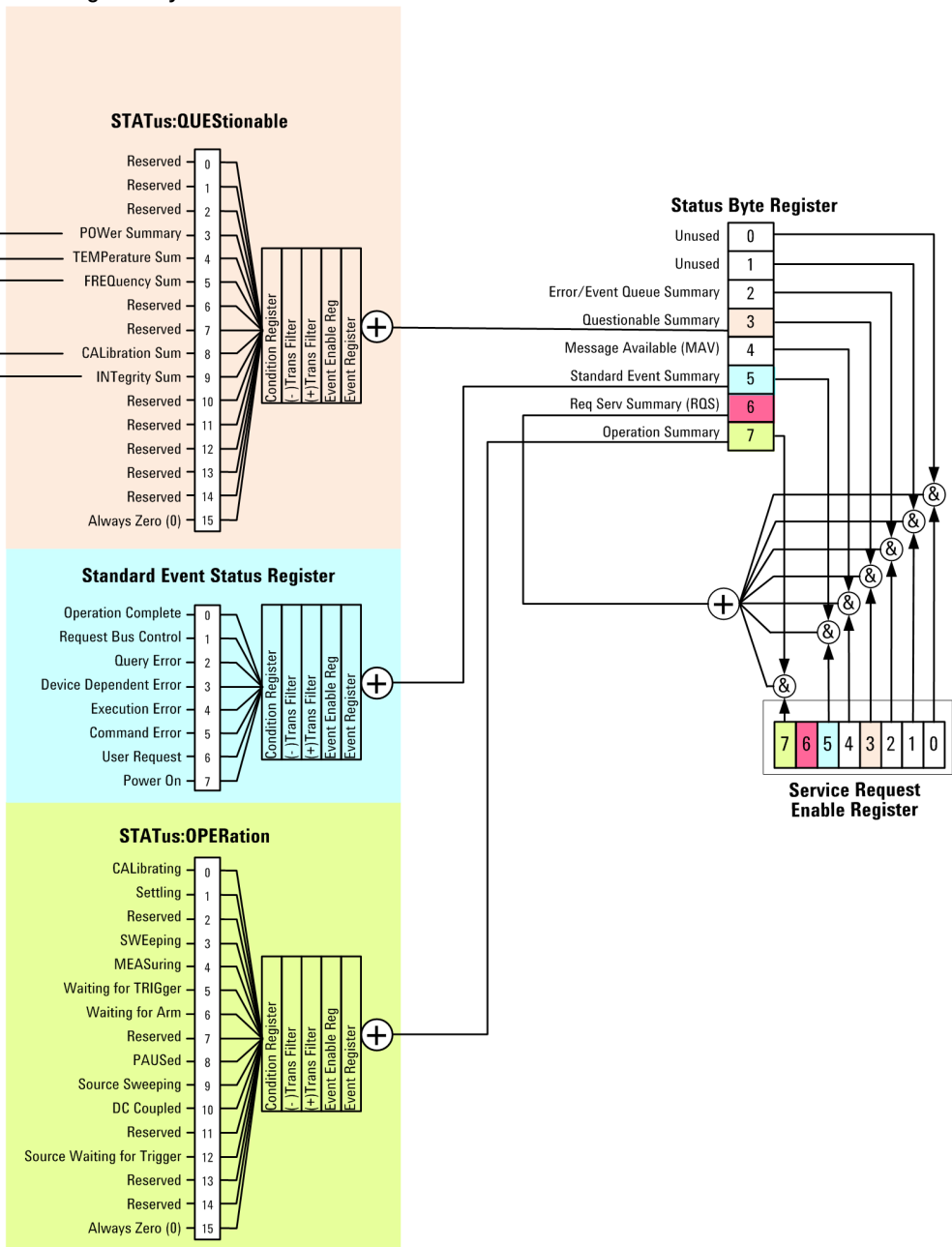

Detailed Description

The STATus subsystem remote commands set and query the status hardware registers. This system of registers monitors various events and conditions in the instrument. Software written to control the instrument may need to monitor some of these events and conditions.

NOTE All status register commands are sequential. Most commands can be started immediately and will overlap with any existing commands that are already running. This is not true of status commands. All the commands in the spectrum analyzer are assumed to be overlapped unless a command description specifically says that it is sequential.

What Are Status Registers

The status system contains multiple registers that are arranged in a hierarchical order. The lower-level status registers propagate their data to the higher-level registers in the data structures by means of summary bits. The status byte register is at the top of the hierarchy and contains general status information for the instrument's events and conditions. All other individual registers are used to determine the specific events or conditions. For a diagram of the registers and their interconnections, see above.

The operation and questionable status registers are sets of registers that monitor the overall instrument condition. They are accessed with the STATus:OPERation and STATus:QUEStionable commands in the STATus command subsystem. Each register set is made up of five registers:

- Condition Register—It reports the real-time state of the signals monitored by this register set. There is no latching or buffering for a condition register.
- Positive Transition Register—This filter register controls which signals will set a bit in the event register when the signal makes a low to high transition (when the condition bit changes from 0 to 1).
- Negative Transition Register—This filter register controls which signals will set a bit in the event register when the signal makes a high to low transition (when the condition bit changes from 1 to 0).
- Event Register—It latches any signal state changes, in the way specified by the filter registers. Bits in the event register are never cleared by signal state changes. Event registers are cleared when read. They are also cleared by *CLS and by presetting the instrument.
- Event Enable Register—It controls which of the bits, being set in the event register, will be summarized as a single output for the register set. Summary bits are then used by the next higher register.

The STATus:QUEStionable registers report abnormal operating conditions. The status register hierarchy is:

1. The summary outputs from the six STATus:QUEStionable:<keyword> detail registers are inputs to the STATus:QUEStionable register.
2. The summary output from the STATus:QUEStionable register is an input to the Status Byte Register. See the overall system in Figure at the beginning of this section.

The STATus:OPERation register set has no summarized inputs. The inputs to the STATus:OPERation:CONDition register indicate the real time state of the instrument. The STATus:OPERation:EVENT register summary output is an input to the Status Byte Register.

What Are Status Register SCPI Commands

Most monitoring of the instrument conditions is done at the highest level using the IEEE common commands indicated below. Complete command descriptions are available in the IEEE commands section at the beginning of the language reference. Individual status registers can be set and queried using the commands in the STATus subsystem of the language reference.

- *CLS (clear status) clears the status byte by emptying the error queue and clearing all the event registers.
- *ESE, *ESE? (event status enable) sets and queries the bits in the enable register part of the standard event status register.
- *ESR? (event status register) queries and clears the event register part of the standard event status register.

- *OPC, *OPC? (operation complete) sets the standard event status register to monitor the completion of all commands. The query stops any new commands from being processed until the current processing is complete, then returns a '1'.
- *PSC, *PSC? (power-on state clear) sets the power-on state so that it clears the service request enable register and the event status enable register at power on.
- *SRE, *SRE? (service request enable) sets and queries the value of the service request enable register.
- *STB? (status byte) queries the value of the status byte register without erasing its contents.

How to Use the Status Registers

A program often needs to be able to detect and manage error conditions or changes in instrument status. There are two methods you can use to programmatically access the information in status registers:

- The polling method
- The service request (SRQ) method

In the polling method, the instrument has a passive role. It only tells the controller that conditions have changed when the controller asks the right question. In the SRQ method, the instrument takes a more active role. It tells the controller when there has been a condition change without the controller asking. Either method allows you to monitor one or more conditions.

The polling method works well if you do not need to know about changes the moment they occur. The SRQ method should be used if you must know immediately when a condition changes. To detect a change using the polling method, the program must repeatedly read the registers.

Use the SRQ method when:

- you need time-critical notification of changes
- you are monitoring more than one device which supports SRQs
- you need to have the controller do something else while waiting
- you can't afford the performance penalty inherent to polling

Use polling when:

- your programming language/development environment does not support SRQ interrupts
- you want to write a simple, single-purpose program and don't want the added complexity of setting up an SRQ handler
- To monitor a condition:
 - a. Determine which register contains the bit that reports the condition.
 - b. Send the unique SCPI query that reads that register.
 - c. Examine the bit to see if the condition has changed.

You can monitor conditions in different ways.

- Check the current instrument hardware and firmware status.

Do this by querying the condition registers which continuously monitor status. These registers represent the current state of the instrument. Bits in a condition register are updated in real time. When the condition monitored by a particular bit becomes true, the bit is set to 1. When the condition becomes false, the bit is reset to 0.

- Monitor a particular condition (bit).

You can enable a particular bit(s), using the event enable register. The instrument will then monitor that particular condition(s). If the bit becomes true (0 to 1 transition) in the event register, it will stay set until the event register is cleared. Querying the event register allows you to detect that this condition occurred even if the condition no longer exists. The event register can only be cleared by querying it or sending the *CLS command.

- Monitor a particular type of change in a condition (bit).
 - The transition registers are preset to register if the condition goes from 0 to 1 (false to true, or a positive transition).
 - This can be changed so the selected condition is detected if the bit goes from 1 to 0 (true to false, or a negative transition).
 - It can also be set for both types of transitions occurring.
 - Or it can be set for neither transition. If both transition registers are set to 0 for a particular bit position, that bit will not be set in the event register for either type of change.

Using a Status Register

Each bit in a register is represented by a numerical value based on its location. See figure below. This number is sent with the command to enable a particular bit. If you want to enable more than one bit, you would send the sum of all the bits that you want to monitor.

Figure: Status Register Bit Values

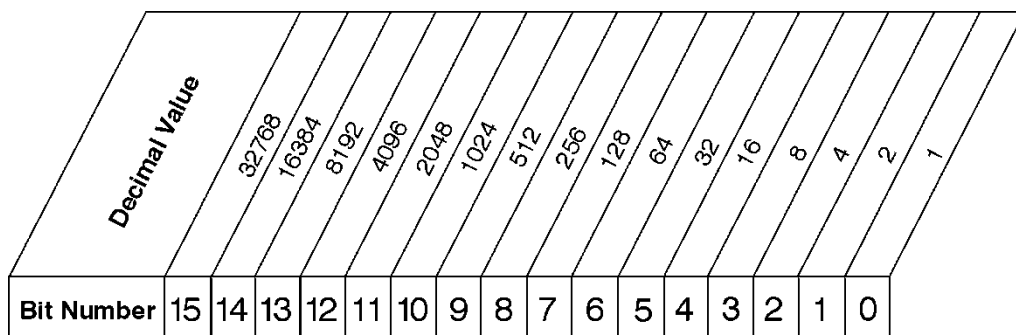

STATus:OPERation:ENABLE < num >
 STATus:OPERation:ENABLE?

Standard Operation Event Enable Register

ck730a

Bit 15 is not used to report status.

Example 1:

1. To enable bit 0 and bit 6 of standard event status register, you would send the command *ESE 65 because 1 + 64 = 65.

2. The results of a query are evaluated in a similar way. If the *STB? command returns a decimal value of 140, ($140 = 128 + 8 + 4$) then bit 7 is true, bit 3 is true and bit 2 is true.

Example 2:

1. Suppose you want to know if an Auto-trigger Timeout occurs, but you only cared about that specific condition. So you would want to know what was happening with bit 10 in the Status Questionable Integrity register, and not about any other bits.
2. It's usually a good idea to start by clearing all the status registers with *CLS.
3. Sending the STAT:QUES:INT:ENAB 1024 command lets you monitor only bit 10 events, instead of the default monitoring all the bits in the register. The register default is for positive transition events (0 to 1 transition). That is, when an auto-trigger timeout occurs. If instead, you wanted to know when the Auto-trigger timeout condition is cleared, then you would set the STAT:QUES:INT:PTR 0 and the STAT:QUES:INT:NTR 32767.
4. So now the only output from the Status Questionable Integrity register will come from a bit 10 positive transition. That output goes to the Integrity Sum bit 9 of the Status Questionable register.
5. You can do a similar thing with this register to only look at bit 9 using, STAT:QUES:ENAB 512.
6. The Status Questionable register output goes to the "Status Questionable Summary" bit 3 of the Status Byte Register. The output from this register can be enabled using the *SRE 8 command.
7. Finally, you would use the serial polling functionality available for the particular bus/software that you are using to monitor the Status Byte Register. (You could also use *STB? to poll the Status Byte Register.)

Using the Service Request (SRQ) Method

Your language, bus, and programming environment must be able to support SRQ interrupts. (For example, BASIC used with VXI-11.3 (GPIB over LAN). When you monitor a condition with the SRQ method, you must:

1. Determine which bit monitors the condition.
2. Determine how that bit reports to the request service (RQS) bit of the status byte.
3. Send SCPI commands to enable the bit that monitors the condition and to enable the summary bits that report the condition to the RQS bit.
4. Enable the controller to respond to service requests.

When the condition changes, the instrument sets its RQS bit. The controller is informed of the change as soon as it occurs. As a result, the time the controller would otherwise have used to monitor the condition can be used to perform other tasks. Your program determines how the controller responds to the SRQ.

Generating a Service Request

To use the SRQ method, you must understand how service requests are generated. Bit 6 of the status byte register is the request service (RQS) bit. The *SRE command is used to configure the RQS bit to report changes in instrument status. When such a change occurs, the RQS bit is set. It is cleared when the status byte register is queried using *SRE? (with a serial poll.) It can be queried without erasing the contents with *STB?.

When a register set causes a summary bit in the status byte to change from 0 to 1, the instrument can initiate the service request (SRQ) process. However, the process is only initiated if both of the following conditions are true:

- The corresponding bit of the service request enable register is also set to 1.
- The instrument does not have a service request pending. (A service request is considered to be pending between the time the instrument's SRQ process is initiated and the time the controller reads the status byte register.)

The SRQ process sets the SRQ true. It also sets the status byte's request service (RQS) bit to 1. Both actions are necessary to inform the controller that the instrument requires service. Setting the SRQ line only informs the controller that some device on the bus requires service. Setting the RQS bit allows the controller to determine which instrument requires service.

If your program enables the controller to detect and respond to service requests, it should instruct the controller to perform a serial poll when the SRQ is set true. Each device on the bus returns the contents of its status byte register in response to this poll. The device whose RQS bit is set to 1 is the device that requested service.

When you read the instrument's status byte register with a serial poll, the RQS bit is reset to 0. Other bits in the register are not affected.

If the status register is configured to SRQ on end-of-measurement and the measurement is in continuous mode, then restarting a measurement (INIT command) can cause the measuring bit to pulse low. This causes an SRQ when you have not actually reached the "end-of-measurement" condition. To avoid this:

1. Set INITiate:CONTinuous off.
2. Set/enable the status registers.
3. Restart the measurement (send INIT).

Status Register System

The hardware status registers are combined to form the instrument status system. Specific status bits are assigned to monitor various aspects of the instrument operation and status. See the diagram of the status system above for information about the bit assignments and status register interconnections.

The Status Byte Register

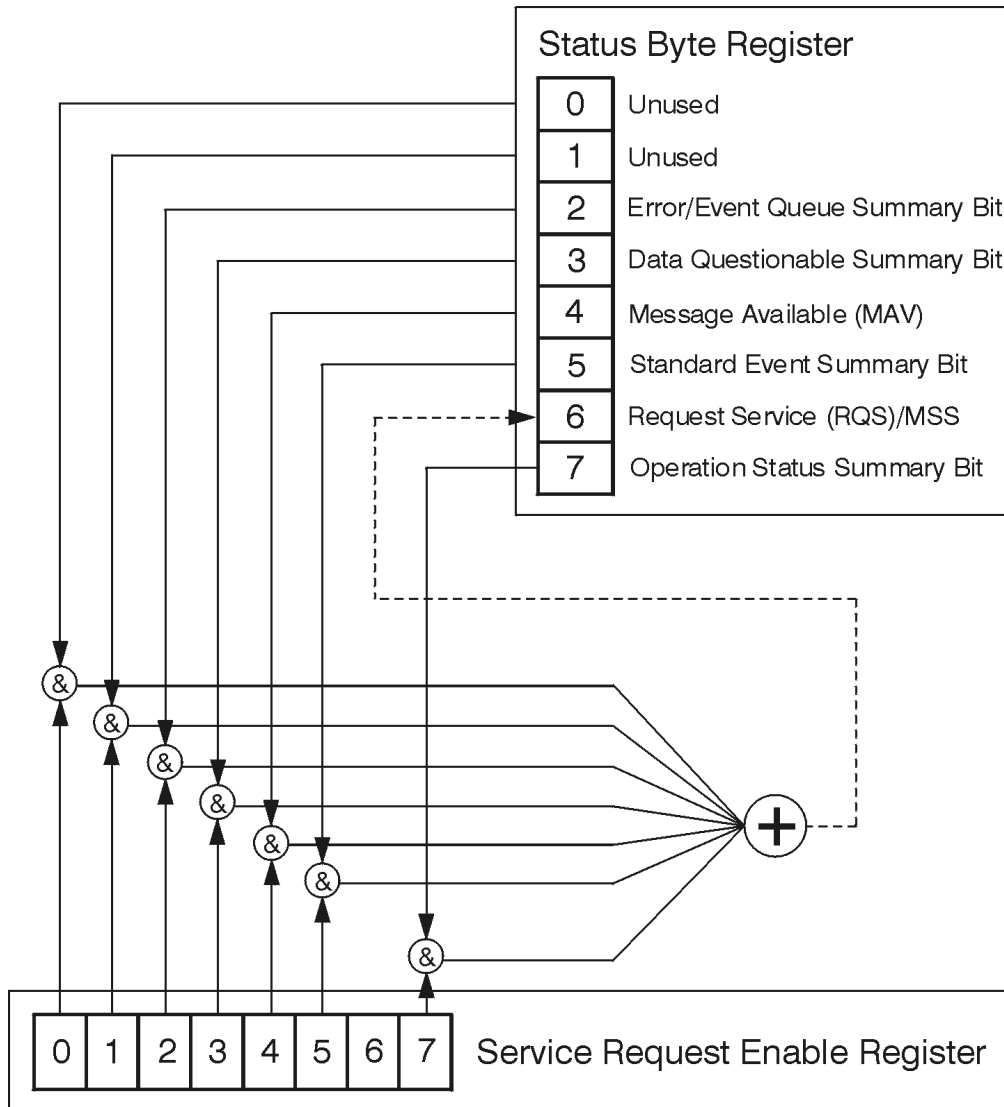

ck776a

The RQS bit is read and reset by a serial poll. The same bit position (MSS) is read, non-destructively by the *STB? command. If you serial poll bit 6 it is read as RQS, but if you send *STB it reads bit 6 as MSS. For more information refer to IEEE 488.2 standards, section 11.

	Description	Standard Operation Status Summary Bit	Request Service (RQS) Summary Bit	Standard Event Status Summary Bit	Message Available (MAV)	Data Questionable Status Summary Bit	Error/Event Queue Summary Bit	Unused	Unused
Bit Number	7	6	5	4	3	2	1	0	

*STB?

Status Byte Register

ck725a

Bit	Description
0, 1	These bits are always set to 0.
2	A 1 in this bit position indicates that the SCPI error queue is not empty which means that it contains at least one error message.
3	A 1 in this bit position indicates that the data questionable summary bit has been set. The data questionable event register can then be read to determine the specific condition that caused this bit to be set.
4	A 1 in this bit position indicates that the instrument has data ready in the output queue. There are no lower status groups that provide input to this bit.
5	A 1 in this bit position indicates that the standard event summary bit has been set. The standard event status register can then be read to determine the specific event that caused this bit to be set.
6	A 1 in this bit position indicates that the instrument has at least one reason to report a status change. This bit is also called the master summary status bit (MSS).
7	A 1 in this bit position indicates that the standard operation summary bit has been set. The standard operation event register can then be read to determine the specific condition that caused this bit to be set.

To query the status byte register, send the command *STB?. The response will be the decimal sum of the bits which are set to 1. For example, if bit number 7 and bit number 3 are set to 1, the decimal sum of the 2 bits is 128 plus 8. So the decimal value 136 is returned. The *STB command does not clear the status register.

In addition to the status byte register, the status byte group also contains the service request enable register. This register lets you choose which bits in the status byte register will trigger a service request.

Send the *SRE <integer> command where <integer> is the sum of the decimal values of the bits you want to enable plus the decimal value of bit 6. For example, assume that you want to enable bit 7 so that whenever the standard operation status register summary bit is set to 1 it will trigger a service request. Send the command *SRE 192 (because 192 = 128 + 64). You must always add 64 (the numeric value of RQS

bit 6) to your numeric sum when you enable any bits for a service request. The command *SRE? returns the decimal value of the sum of the bits previously enabled with the *SRE <integer> command.

The service request enable register presets to zeros (0).

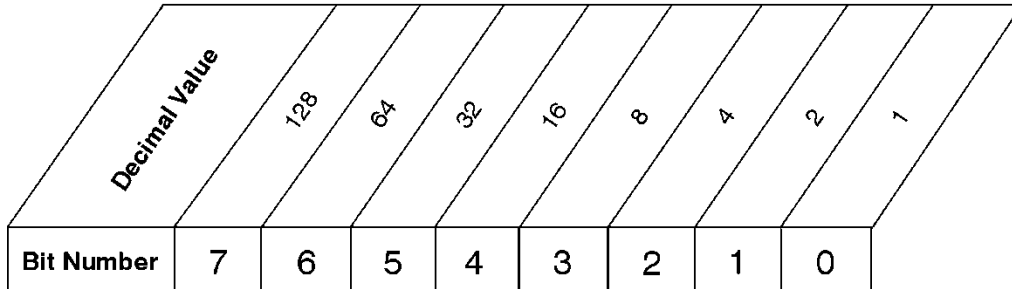

*SRE <num>
 *SRE?

Service Request Enable Register

ck726a

Standard Event Status Register

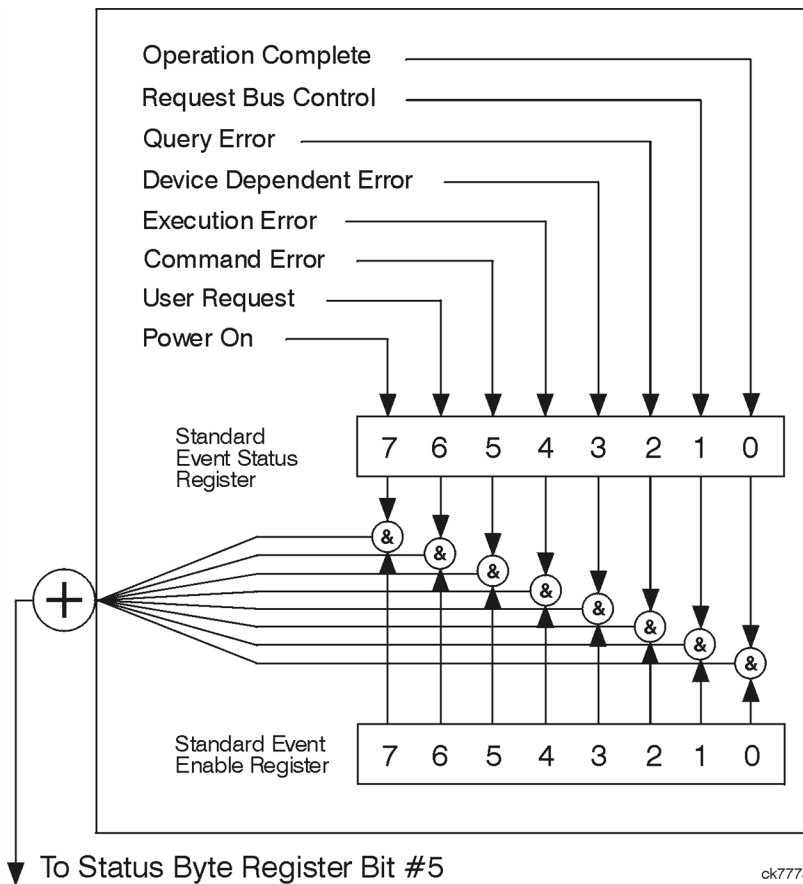

The standard event status register contains the following bits:

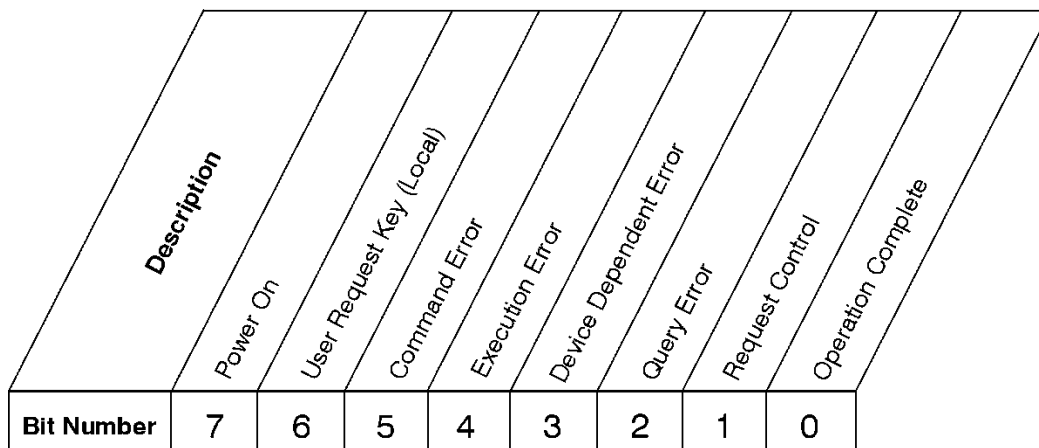

*ESR?

Standard Event Status Register

ck727a

Bit	Description
0	A 1 in this bit position indicates that all pending operations were completed following execution of the *OPC command.
1	This bit is for GPIB handshaking to request control. Currently it is set to 0 because there are no implementations where the spectrum analyzer controls another instrument.
2	A 1 in this bit position indicates that a query error has occurred. Query errors have SCPI error numbers from -499 to -400.
3	A 1 in this bit position indicates that a device dependent error has occurred. Device dependent errors have SCPI error numbers from -399 to -300 and 1 to 32767.
4	A 1 in this bit position indicates that an execution error has occurred. Execution errors have SCPI error numbers from -299 to -200.
5	A 1 in this bit position indicates that a command error has occurred. Command errors have SCPI error numbers from -199 to -100.
6	A 1 in this bit position indicates that the LOCAL key has been pressed. This is true even if the instrument is in local lockout mode.
7	A 1 in this bit position indicates that the instrument has been turned off and then on.

The standard event status register is used to determine the specific event that set bit 5 in the status byte register. To query the standard event status register, send the command *ESR?. The response will be the decimal sum of the bits which are enabled (set to 1). For example, if bit number 7 and bit number 3 are enabled, the decimal sum of the 2 bits is 128 plus 8. So the decimal value 136 is returned.

In addition to the standard event status register, the standard event status group also contains a standard event status enable register. This register lets you choose which bits in the standard event status register will set the summary bit (bit 5 of the status byte register) to 1. Send the *ESE <integer> command where <integer> is the sum of the decimal values of the bits you want to enable. For example, to enable bit 7 and bit 6 so that whenever either of those bits is set to 1, the standard event status summary bit of the status

byte register will be set to 1, send the command *ESE 192 (128 + 64). The command *ESE? returns the decimal value of the sum of the bits previously enabled with the *ESE <integer> command.

The standard event status enable register presets to zeros (0).

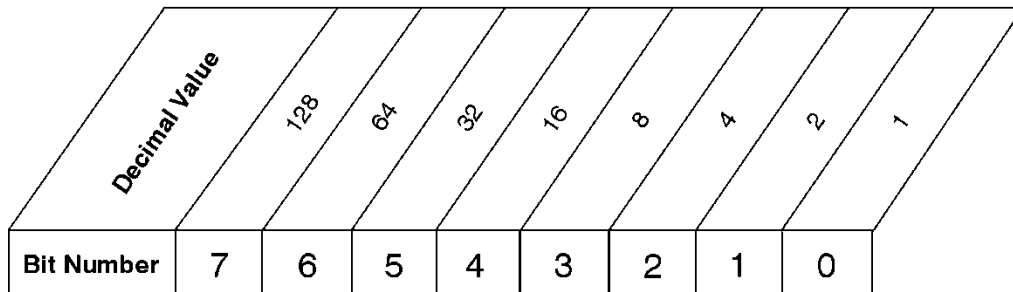

*ESE <num>
 *ESE?

Standard Event Status Enable Register

ck728a

Operation and Questionable Status Registers

The operation and questionable status registers are registers that monitor the overall instrument condition. They are accessed with the STATUS:OPERation and STATUS:QUESTionable commands in the STATUS command subsystem. See the figure at the beginning of this chapter.

Operation Status Register

The operation status register monitors the current instrument measurement state. It checks to see if the instrument is calibrating, sweeping, or waiting for a trigger. For more information see the *OPC? command located in the IEEE Common Commands section.

Bit	Condition	Operation
0	Calibrating	The instrument is busy executing its Align Now process
3	Sweeping	The instrument is busy taking a sweep.
4	Measuring	The instrument is busy making a measurement. Measurements often require multiple sweeps. They are initiated by keys under the MEASURE key or with the MEASure group of commands. The bit is valid for most X-Series Modes.
5	Waiting for trigger	The instrument is waiting for the trigger conditions to be met, then it will trigger a sweep or measurement.

Questionable Status Register

The questionable status register monitors the instrument's condition to see if anything questionable has happened to it. It is looking for anything that might cause an error or a bad measurement like a hardware problem, an out of calibration situation, or a unusual signal. All the bits are summary bits from lower-level event registers.

Bit	Condition	Operation
-----	-----------	-----------

3	Power summary	The instrument hardware has detected a power unlevelled condition.
4	Temperature summary	The instrument is still warming up.
5	Frequency summary	The instrument hardware has detected an unlocked condition or a problem with the external frequency reference.
8	Calibration summary	The instrument has detected a hardware problem while doing the automatic internal alignment process.
9	Integrity summary	The instrument has detected a questionable measurement condition such as: bad timing, bad signal/data, timeout problem, signal overload, or "meas uncal".

STATus Subsystem Command Descriptions

The STATus subsystem controls the SCPI-defined instrument status reporting structures. Each status register has a set of five commands used for querying or masking that particular register.

Numeric values for bit patterns can be entered using decimal or hexadecimal representations. (i.e. 0 to 32767 is equivalent to #H0 to #H7FFF. It is also equal to all ones, 11111111111111) See the SCPI Basics information about using bit patterns for variable parameters.

Operation Register

"Operation Condition Query" on page 98

"Operation Enable" on page 99

"Operation Event Query" on page 99

"Operation Negative Transition" on page 99

"Operation Positive Transition" on page 100

Operation Condition Query

This query returns the decimal value of the sum of the bits in the Status Operation Condition register.

NOTE The data in this register is continuously updated and reflects the current conditions.

Mode	All
Remote Command	:STATus:OPERation:CONDition?
Example	STAT:OPER:COND?
Preset	0
Status Bits/OPC dependencies	Sequential command
Initial S/W Revision	Prior to A.02.00

Operation Enable

This command determines which bits in the Operation Event register, will set the Operation Status Summary bit (bit 7) in the Status Byte Register. The variable <integer> is the sum of the decimal values of the bits you want to enable.

NOTE

The preset condition is to have all bits in this enable register set to 0. To have any Operation Events reported to the Status Byte Register, one or more bits need to be set to 1.

Mode	All
Remote Command	:STATus:OPERation:ENABle <integer> :STATus:OPERation:ENABle?
Example	STAT:OPER:ENAB 1 Sets the register so that Align Now operation will be reported to the Status Byte Register.
Preset	0
Min	0
Max	32767
Status Bits/OPC dependencies	Sequential command
Initial S/W Revision	Prior to A.02.00

Operation Event Query

This query returns the decimal value of the sum of the bits in the Operation Event register.

NOTE

The register requires that the associated PTR or NTR filters be set before a condition register bit can set a bit in the event register. The data in this register is latched until it is queried. Once queried, the register is cleared.

Mode	All
Remote Command	:STATus:OPERation[:EVENT]?
Example	STAT:OPER?
Preset	0
Status Bits/OPC dependencies	Sequential command
Initial S/W Revision	Prior to A.02.00

Operation Negative Transition

This command determines which bits in the Operation Condition register will set the corresponding bit in the Operation Event register when the condition register bit has a negative transition (1 to 0). The variable <integer> is the sum of the decimal values of the bits that you want to enable.

Mode	All
Remote Command	:STATus:OPERation:NTRansition <integer> :STATus:OPERation:NTRansition?
Example	STAT:OPER:NTR 1 Align Now operation complete will be reported to the Status Byte Register.
Preset	0
Min	0
Max	32767
Status Bits/OPC dependencies	Sequential command
Initial S/W Revision	Prior to A.02.00

Operation Positive Transition

This command determines which bits in the Operation Condition register will set the corresponding bit in the Operation Event register when the condition register bit has a positive transition (0 to 1). The variable <integer> is the sum of the decimal values of the bits that you want to enable.

Mode	All
Remote Command	:STATus:OPERation:PTRansition <integer> :STATus:OPERation:PTRansition?
Example	STAT:OPER:PTR 1 Align Now operation beginning will be reported to the Status Byte Register.
Preset	32767
Min	0
Max	32767
Status Bits/OPC dependencies	Sequential command
Initial S/W Revision	Prior to A.02.00

Preset the Status Byte

Sets bits in most of the enable and transition registers to their default state. It presets all the Transition Filters, Enable Registers, and the Error/Event Queue Enable. It has no effect on Event Registers, Error/Event QUEUE, IEEE 488.2 ESE, and SRE Registers as described in IEEE Standard 488.2–1992, IEEE Standard Codes, Formats, Protocols, and Common Commands for Use with ANSI/IEEE Std 488.1–1987. New York, NY, 1992.

Remote Command	:STATus:PRESet
Example	STAT:PRES
Initial S/W Revision	Prior to A.02.00

Questionable Register

"Questionable Condition " on page 101

"Questionable Enable " on page 101

"Questionable Event Query " on page 102

"Questionable Negative Transition " on page 102

"Questionable Positive Transition" on page 102

Questionable Condition

This query returns the decimal value of the sum of the bits in the Questionable Condition register.

NOTE

The data in this register is continuously updated and reflects the current conditions.

Mode	All
Remote Command	:STATus:QUESTionable:CONDition?
Example	STAT:QUES:COND?
Preset	0
Status Bits/OPC dependencies	Sequential command
Initial S/W Revision	Prior to A.02.00

Questionable Enable

This command determines which bits in the Questionable Event register will set the Questionable Status Summary bit (bit3) in the Status Byte Register. The variable <integer> is the sum of the decimal values of the bits you want to enable.

NOTE

The preset condition is all bits in this enable register set to 0. To have any Questionable Events reported to the Status Byte Register, one or more bits need to be set to 1. The Status Byte Event Register should be queried after each measurement to check the Questionable Status Summary (bit 3). If it is equal to 1, a condition during the test may have made the test results invalid. If it is equal to 0, this indicates that no hardware problem or measurement problem was detected by the analyzer.

Mode	All
Remote Command	:STATus:QUESTionable:ENABle <integer> :STATus:QUESTionable:ENABle?
Example	STAT:OPER:PTR 1 Align Now operation beginning will be reported to the Status Byte Register.
Preset	0
Min	0
Max	32767
Status Bits/OPC dependencies	Sequential command

Initial S/W Revision Prior to A.02.00

Questionable Event Query

This query returns the decimal value of the sum of the bits in the Questionable Event register.

NOTE

The register requires that the associated PTR or NTR filters be set before a condition register bit can set a bit in the event register. The data in this register is latched until it is queried. Once queried, the register is cleared.

Mode	All
Remote Command	:STATus:QUEStionable[:EVENT]?
Example	STAT:QUES?
Preset	0
Status Bits/OPC dependencies	Sequential command
Initial S/W Revision	Prior to A.02.00

Questionable Negative Transition

This command determines which bits in the Questionable Condition register will set the corresponding bit in the Questionable Event register when the condition register bit has a negative transition (1 to 0). The variable <integer> is the sum of the decimal values of the bits that you want to enable.

Mode	All
Remote Command	:STATus:QUEStionable:NTRansition <integer> :STATus:QUEStionable:NTRansition?
Example	STAT:QUES:NTR 16 Temperature summary 'questionable cleared' will be reported to the Status Byte Register.
Preset	0
Min	0
Max	32767
Status Bits/OPC dependencies	Sequential command
Initial S/W Revision	Prior to A.02.00

Questionable Positive Transition

This command determines which bits in the Questionable Condition register will set the corresponding bit in the Questionable Event register when the condition register bit has a positive transition (0 to 1). The variable <integer> is the sum of the decimal values of the bits that you want to enable.

Mode	All
Remote Command	:STATus:QUEStionable:PTRansition <integer> :STATus:QUEStionable:PTRansition?
Example	STAT:QUES:PTR 16 Temperature summary 'questionable asserted' will be reported to the Status Byte Register.
Preset	32767
Min	0
Max	32767
Status Bits/OPC dependencies	Sequential command
Initial S/W Revision	Prior to A.02.00

Questionable Calibration Register

"Questionable Calibration Condition " on page 103

"Questionable Calibration Enable " on page 103

"Questionable Calibration Event Query " on page 104

"Questionable Calibration Negative Transition " on page 104

"Questionable Calibration Positive Transition " on page 105

Questionable Calibration Condition

This query returns the decimal value of the sum of the bits in the Questionable Calibration Condition register.

NOTE

The data in this register is continuously updated and reflects the current conditions.

Mode	All
Remote Command	:STATus:QUEStionable:CALibration:CONDition?
Example	STAT:QUES:CAL:COND?
Preset	0
Status Bits/OPC dependencies	Sequential command
Initial S/W Revision	Prior to A.02.00

Questionable Calibration Enable

This command determines which bits in the Questionable Calibration Condition Register will set bits in the Questionable Calibration Event register, which also sets the Calibration Summary bit (bit 8) in the

Questionable Register. The variable <integer> is the sum of the decimal values of the bits you want to enable.

Mode	All
Remote Command	:STATus:QUESTionable:CALibration:ENABle <integer> :STATus:QUESTionable:CALibration:ENABle?
Example	STAT:QUES:CAL:ENAB 16384 Can be used to query if an alignment is needed, if you have turned off the automatic alignment process.
Min	0
Max	32767
Status Bits/OPC dependencies	Sequential command
Initial S/W Revision	Prior to A.02.00

Questionable Calibration Event Query

This query returns the decimal value of the sum of the bits in the Questionable Calibration Event register.

NOTE

The register requires that the associated PTR or NTR filters be set before a condition register bit can set a bit in the event register. The data in this register is latched until it is queried. Once queried, the register is cleared.

Mode	All
Remote Command	:STATus:QUESTionable:CALibration[:EVENT]?
Example	STAT:QUES:CAL?
Preset	0
Status Bits/OPC dependencies	Sequential command
Initial S/W Revision	Prior to A.02.00

Questionable Calibration Negative Transition

This command determines which bits in the Questionable Calibration Condition register will set the corresponding bit in the Questionable Calibration Event register when the condition register bit has a negative transition (1 to 0). The variable <integer> is the sum of the decimal values of the bits that you want to enable.

Mode	All
Remote Command	:STATus:QUESTionable:CALibration:NTRansition <integer> :STATus:QUESTionable:CALibration:NTRansition?
Example	STAT:QUES:CAL:NTR 16384 Alignment is not required.
Preset	0

Min	0
Max	32767
Status Bits/OPC dependencies	Sequential command
Initial S/W Revision	Prior to A.02.00

Questionable Calibration Positive Transition

This command determines which bits in the Questionable Calibration Condition register will set the corresponding bit in the Questionable Calibration Event register when the condition register bit has a positive transition (0 to 1). The variable <integer> is the sum of the decimal values of the bits that you want to enable.

Mode	All
Remote Command	:STATus:QUEStionable:CALibration:PTRansition <integer> :STATus:QUEStionable:CALibration:PTRansition?
Example	STAT:QUES:CAL:PTR 16384 Alignment is required.
Preset	32767
Min	0
Max	32767
Status Bits/OPC dependencies	Sequential command
Initial S/W Revision	Prior to A.02.00

Questionable Calibration Skipped Register

"Questionable Calibration Skipped Condition " on page 105

"Questionable Calibration Skipped Enable " on page 106

"Questionable Calibration Skipped Event Query " on page 106

"Questionable Calibration Skipped Negative Transition " on page 107

"Questionable Calibration Skipped Positive Transition " on page 107

Questionable Calibration Skipped Condition

This query returns the decimal value of the sum of the bits in the Questionable Calibration Skipped Condition register.

NOTE The data in this register is continuously updated and reflects the current conditions.

Mode	All
------	-----

Remote Command	:STATus:QUESTionable:CALibration:SKIpped:CONDition?
Example	STAT:QUES:CAL:SKIP:COND?
Preset	0
Status Bits/OPC dependencies	Sequential command
Initial S/W Revision	Prior to A.02.00

Questionable Calibration Skipped Enable

This command determines which bits in the Questionable Calibration Skipped Condition Register will set bits in the Questionable Calibration Skipped Event register, which also sets bit 11 of the Questionable Calibration Register. The variable <integer> is the sum of the decimal values of the bits you want to enable.

Mode	All
Remote Command	:STATus:QUESTionable:CALibration:SKIpped:ENABle <integer> :STATus:QUESTionable:CALibration:SKIpped:ENABle?
Example	STAT:QUES:CAL:SKIP:ENAB 1 Can be used to query if an EMI alignment skipped condition is detected
Preset	32767
Min	0
Max	32767
Status Bits/OPC dependencies	Sequential command
Initial S/W Revision	Prior to A.02.00

Questionable Calibration Skipped Event Query

This query returns the decimal value of the sum of the bits in the Questionable Calibration Event register.

NOTE The register requires that the associated PTR or NTR filters be set before a condition register bit can set a bit in the event register. The data in this register is latched until it is queried. Once queried, the register is cleared.

Mode	All
Remote Command	:STATus:QUESTionable:CALibration:SKIpped[:EVENT]?
Example	STAT:QUES:CAL:SKIP?
Preset	0
Status Bits/OPC dependencies	Sequential command
Initial S/W Revision	Prior to A.02.00

Questionable Calibration Skipped Negative Transition

This command determines which bits in the Questionable Calibration Skipped Condition register will set the corresponding bit in the Questionable Calibration Skipped Event register when the condition register bit has a negative transition (1 to 0). The variable <integer> is the sum of the decimal values of the bits that you want to enable.

Mode	All
Remote Command	:STATus:QUEStionable:CALibration:SKIpped:NTRansition <integer> :STATus:QUEStionable:CALibration:SKIpped:NTRansition?
Example	STAT:QUES:CAL:SKIP:NTR 1 Align RF skipped is not required.
Preset	0
Min	0
Max	32767
Status Bits/OPC dependencies	Sequential command
Initial S/W Revision	Prior to A.02.00

Questionable Calibration Skipped Positive Transition

This command determines which bits in the Questionable Calibration Skipped Condition register will set the corresponding bit in the Questionable Calibration Skipped Event register when the condition register bit has a positive transition (0 to 1). The variable <integer> is the sum of the decimal values of the bits that you want to enable.

Mode	All
Remote Command	:STATus:QUEStionable:CALibration:SKIpped:PTRansition <integer> :STATus:QUEStionable:CALibration:SKIpped:PTRansition?
Example	STAT:QUES:CAL:SKIP:PTR 1 Align RF skipped is required.
Preset	32767
Min	0
Max	32767
Status Bits/OPC dependencies	Sequential command
Initial S/W Revision	Prior to A.02.00

Questionable Calibration Extended Failure Register

"Questionable Calibration Extended Failure Condition " on page 108

"Questionable Calibration Extended Failure Enable " on page 108

"Questionable Calibration Extended Failure Event Query " on page 108

"Questionable Calibration Extended Failure Negative Transition " on page 109

"Questionable Calibration Extended Failure Positive Transition " on page 109

Questionable Calibration Extended Failure Condition

This query returns the decimal value of the sum of the bits in the Questionable Calibration Extended Failure Condition register.

NOTE	The data in this register is continuously updated and reflects the current conditions.
Mode	All
Remote Command	:STATus:QUES:CALibration:EXTended:FAILure:CONDition?
Example	STAT:QUES:CAL:EXT:FAIL:COND?
Preset	0
Status Bits/OPC dependencies	Sequential command
Initial S/W Revision	Prior to A.02.00

Questionable Calibration Extended Failure Enable

This command determines which bits in the Questionable Calibration Extended Failure Condition Register will set bits in the Questionable Calibration Extended Failure Event register, which also sets bit 9 of the Questionable Calibration Register. The variable <integer> is the sum of the decimal values of the bits you want to enable.

Mode	All
Remote Command	:STATus:QUES:CALibration:EXTended:FAILure:ENABle <integer> :STATus:QUES:CALibration:EXTended:FAILure:ENABle?
Example	STAT:QUES:CAL:EXT:FAIL:ENAB 1 Can be used to query if an EMI conducted alignment is needed.
Preset	32767
Min	0
Max	32767
Status Bits/OPC dependencies	Sequential command
Initial S/W Revision	Prior to A.02.00

Questionable Calibration Extended Failure Event Query

This query returns the decimal value of the sum of the bits in the Questionable Calibration Extended Failure Event register.

NOTE	The register requires that the associated PTR or NTR filters be set before a condition register bit can set a bit in the event register. The data in this register is latched until it is queried. Once queried, the register is cleared.
-------------	---

Mode	All
Remote Command	:STATus:QUESTionable:CALibration:EXTended:FAILure[:EVENT]?
Example	STAT:QUES:CAL:EXT:FAIL?
Preset	0
Status Bits/OPC dependencies	Sequential command
Initial S/W Revision	Prior to A.02.00

Questionable Calibration Extended Failure Negative Transition

This command determines which bits in the Questionable Calibration Extended Failure Condition register will set the corresponding bit in the Questionable Calibration Extended Failure Event register when the condition register bit has a negative transition (1 to 0). The variable <integer> is the sum of the decimal values of the bits that you want to enable.

Mode	All
Remote Command	:STATus:QUESTionable:CALibration:EXTended:FAILure:NTRansition <integer> :STATus:QUESTionable:CALibration:EXTended:FAILure:NTRansition?
Example	STAT:QUES:CAL:EXT:FAIL:NTR 1 EMI conducted align failure is not required.
Preset	0
Min	0
Max	32767
Status Bits/OPC dependencies	Sequential command
Initial S/W Revision	Prior to A.02.00

Questionable Calibration Extended Failure Positive Transition

This command determines which bits in the Questionable Calibration Extended Failure Condition register will set the corresponding bit in the Questionable Calibration Extended Failure Event register when the condition register bit has a positive transition (0 to 1). The variable <integer> is the sum of the decimal values of the bits that you want to enable.

Mode	All
Remote Command	:STATus:QUESTionable:CALibration:EXTended:FAILure:PTRansition <integer> :STATus:QUESTionable:CALibration:EXTended:FAILure:PTRansition?
Example	STAT:QUES:CAL:EXT:FAIL:PTR 1 EMI conducted align failure is required.
Preset	32767
Min	0
Max	32767

Status Bits/OPC dependencies	Sequential command
Initial S/W Revision	Prior to A.02.00

Questionable Calibration Extended Needed Register

- "Questionable Calibration Extended Needed Condition " on page 110
- "Questionable Calibration Extended Needed Enable " on page 110
- "Questionable Calibration Extended Needed Event Query " on page 111
- "Questionable Calibration Extended Needed Negative Transition " on page 111
- "Questionable Calibration Extended Needed Positive Transition " on page 112

Questionable Calibration Extended Needed Condition

This query returns the decimal value of the sum of the bits in the Questionable Calibration Extended Needed Condition register.

NOTE The data in this register is continuously updated and reflects the current conditions.

Mode	All
Remote Command	:STATus:QUESTionable:CALibration:EXTended:NEEDed:CONDition?
Example	STAT:QUES:CAL:EXT:NEED:COND?
Preset	0
Status Bits/OPC dependencies	Sequential command
Initial S/W Revision	Prior to A.02.00

Questionable Calibration Extended Needed Enable

This command determines which bits in the Questionable Calibration Extended Needed Condition Register will set bits in the Questionable Calibration Extended Needed Event register, which also sets bit 14 of the Questionable Calibration Register. The variable <integer> is the sum of the decimal values of the bits you want to enable.

Mode	All
Remote Command	:STATus:QUESTionable:CALibration:EXTended:NEEDed:ENABle <integer> :STATus:QUESTionable:CALibration:EXTended:NEEDed:ENABle?
Example	STAT:QUES:CAL:EXT:NEED:ENAB 2 Can be used to query if an EMI conducted alignment is needed.
Preset	32767
Min	0

Max	32767
Status Bits/OPC dependencies	Sequential command
Initial S/W Revision	Prior to A.02.00

Questionable Calibration Extended Needed Event Query

This query returns the decimal value of the sum of the bits in the Questionable Calibration Extended Needed Event register.

NOTE

The register requires that the associated PTR or NTR filters be set before a condition register bit can set a bit in the event register. The data in this register is latched until it is queried. Once queried, the register is cleared.

Mode	All
Remote Command	:STATus:QUESTionable:CALibration:EXTended:NEEDED[:EVENT]?
Example	STAT:QUES:CAL:EXT:NEED?
Preset	0
Status Bits/OPC dependencies	Sequential command
Initial S/W Revision	Prior to A.02.00

Questionable Calibration Extended Needed Negative Transition

This command determines which bits in the Questionable Calibration Extended Needed Condition register will set the corresponding bit in the Questionable Calibration Extended Needed Event register when the condition register bit has a negative transition (1 to 0). The variable <integer> is the sum of the decimal values of the bits that you want to enable.

Mode	All
Remote Command	:STATus:QUESTionable:CALibration:EXTended:NEEDED:NTRansition <integer> :STATus:QUESTionable:CALibration:EXTended:NEEDED:NTRansition?
Example	STAT:QUES:CAL:EXT:NEED:NTR 2 Align EMI conducted is not required.
Preset	0
Min	0
Max	32767
Status Bits/OPC dependencies	Sequential command
Initial S/W Revision	Prior to A.02.00

Questionable Calibration Extended Needed Positive Transition

This command determines which bits in the Questionable Calibration Extended Needed Condition register will set the corresponding bit in the Questionable Calibration Extended Needed Event register when the condition register bit has a positive transition (0 to 1). The variable <integer> is the sum of the decimal values of the bits that you want to enable.

Mode	All
Remote Command	:STATus:QUESTionable:CALibration:EXTended:NEEDed:PTRansition <integer> :STATus:QUESTionable:CALibration:EXTended:NEEDed:PTRansition?
Example	STAT:QUES:CAL:EXT:NEED:PTR 2 Align EMI conducted is required.
Preset	32767
Min	0
Max	32767
Status Bits/OPC dependencies	Sequential command
Initial S/W Revision	Prior to A.02.00

Questionable Frequency Register

"Questionable Frequency Condition " on page 112

"Questionable Frequency Enable " on page 113

"Questionable Frequency Event Query " on page 113

"Questionable Frequency Negative Transition " on page 113

"Questionable Frequency Positive Transition " on page 114

Questionable Frequency Condition

This query returns the decimal value of the sum of the bits in the Questionable Frequency Condition register.

NOTE

The data in this register is continuously updated and reflects the current conditions.

Mode	All
Remote Command	:STATus:QUESTionable:FREQuency:CONDition?
Example	STAT:QUES:FREQ:COND?
Preset	0
Status Bits/OPC dependencies	Sequential command
Initial S/W Revision	Prior to A.02.00

Questionable Frequency Enable

This command determines which bits in the Questionable Frequency Condition Register will set bits in the Questionable Frequency Event register, which also sets the Frequency Summary bit (bit 5) in the Questionable Register. The variable <integer> is the sum of the decimal values of the bits you want to enable.

Mode	All
Remote Command	:STATus:QUEStionable:FREQuency:ENABle <integer> :STATus:QUEStionable:FREQuency:ENABle?
Example	STAT:QUES:FREQ:ENAB 2 Frequency Reference Unlocked will be reported to the Frequency Summary of the Status Questionable register.
Preset	32767
Min	0
Max	32767
Status Bits/OPC dependencies	Sequential command
Initial S/W Revision	Prior to A.02.00

Questionable Frequency Event Query

This query returns the decimal value of the sum of the bits in the Questionable Frequency Event register.

NOTE

The register requires that the associated PTR or NTR filters be set before a condition register bit can set a bit in the event register. The data in this register is latched until it is queried. Once queried, the register is cleared.

Mode	All
Remote Command	:STATus:QUEStionable:FREQuency[:EVENT]?
Example	STAT:QUES:FREQ?
Preset	0
Status Bits/OPC dependencies	Sequential command
Initial S/W Revision	Prior to A.02.00

Questionable Frequency Negative Transition

This command determines which bits in the Questionable Frequency Condition register will set the corresponding bit in the Questionable Frequency Event register when the condition register bit has a negative transition (1 to 0). The variable <integer> is the sum of the decimal values of the bits that you want to enable.

Mode	All
------	-----

Remote Command	:STATus:QUESTionable:FREQuency:NTRansition <integer> :STATus:QUESTionable:FREQuency:NTRansition?
Example	STAT:QUES:FREQ:NTR 2 Frequency Reference 'regained lock' will be reported to the Frequency Summary of the Status Questionable register.
Preset	0
Min	0
Max	32767
Status Bits/OPC dependencies	Sequential command
Initial S/W Revision	Prior to A.02.00

Questionable Frequency Positive Transition

This command determines which bits in the Questionable Frequency Condition register will set the corresponding bit in the Questionable Frequency Event register when the condition register bit has a positive transition (0 to 1). The variable <integer> is the sum of the decimal values of the bits that you want to enable.

Mode	All
Remote Command	:STATus:QUESTionable:FREQuency:PTRansition <integer> :STATus:QUESTionable:FREQuency:PTRansition?
Example	STAT:QUES:FREQ:PTR 2 Frequency Reference 'became unlocked' will be reported to the Frequency Summary of the Status Questionable register.
Preset	32767
Min	0
Max	32767
Status Bits/OPC dependencies	Sequential command
Initial S/W Revision	Prior to A.02.00

Questionable Integrity Register

["Questionable Integrity Condition " on page 114](#)

["Questionable Integrity Enable " on page 115](#)

["Questionable Integrity Event Query " on page 115](#)

["Questionable Integrity Negative Transition " on page 116](#)

["Questionable Integrity Positive Transition " on page 116](#)

Questionable Integrity Condition

This query returns the decimal value of the sum of the bits in the Questionable Integrity Condition register.

NOTE

The data in this register is continuously updated and reflects the current conditions.

Mode	All
Remote Command	:STATus:QUEStionable:INTEgrity:CONDition?
Example	STAT:QUES:INT:COND?
Preset	0
Status Bits/OPC dependencies	Sequential command
Initial S/W Revision	Prior to A.02.00

Questionable Integrity Enable

This command determines which bits in the Questionable Integrity Condition Register will set bits in the Questionable Integrity Event register, which also sets the Integrity Summary bit (bit 9) in the Questionable Register. The variable <integer> is the sum of the decimal values of the bits you want to enable.

Mode	All
Remote Command	:STATus:QUEStionable:INTEgrity:ENABle <integer> :STATus:QUEStionable:INTEgrity:ENABle?
Example	STAT:QUES:INT:ENAB 8 Measurement Uncalibrated Summary will be reported to the Integrity Summary of the Status Questionable register.
Preset	32767
Min	0
Max	32767
Status Bits/OPC dependencies	Sequential command
Initial S/W Revision	Prior to A.02.00

Questionable Integrity Event Query

This query returns the decimal value of the sum of the bits in the Questionable Integrity Event register.

NOTE

The register requires that the associated PTR or NTR filters be set before a condition register bit can set a bit in the event register. The data in this register is latched until it is queried. Once queried, the register is cleared.

Mode	All
Remote Command	:STATus:QUEStionable:INTEgrity[:EVENT]?
Example	STAT:QUES:INT?
Preset	0
Status Bits/OPC dependencies	Sequential command

Initial S/W Revision	Prior to A.02.00
----------------------	------------------

Questionable Integrity Negative Transition

This command determines which bits in the Questionable Integrity Condition register will set the corresponding bit in the Questionable Integrity Event register when the condition register bit has a negative transition (1 to 0)

The variable <integer> is the sum of the decimal values of the bits that you want to enable.

Mode	All
Remote Command	:STATus:QUEStionable:INTEgrity:NTRansition <integer> :STATus:QUEStionable:INTEgrity:NTRansition?
Example	STAT:QUES:INT:NTR 8 Measurement 'regained calibration' Summary will be reported to the Integrity Summary of the Status Questionable register.
Preset	0
Min	0
Max	32767
Status Bits/OPC dependencies	Sequential command
Initial S/W Revision	Prior to A.02.00

Questionable Integrity Positive Transition

This command determines which bits in the Questionable Integrity Condition register will set the corresponding bit in the Questionable Integrity Event register when the condition register bit has a positive transition (0 to 1). The variable <integer> is the sum of the decimal values of the bits that you want to enable.

Mode	All
Remote Command	:STATus:QUEStionable:INTEgrity:PTRansition <integer> :STATus:QUEStionable:INTEgrity:PTRansition?
Example	STAT:QUES:INT:PTR 8 Measurement 'became uncalibrated' Summary will be reported to the Integrity Summary of the Status Questionable register.
Preset	32767
Min	0
Max	32767
Status Bits/OPC dependencies	Sequential command
Initial S/W Revision	Prior to A.02.00

Questionable Integrity Signal Register

"Questionable Integrity Signal Condition" on page 117

"Questionable Integrity Signal Enable" on page 117

"Questionable Integrity Signal Event Query" on page 118

"Questionable Integrity Signal Negative Transition" on page 118

"Questionable Integrity Signal Positive Transition" on page 118

Questionable Integrity Signal Condition

This query returns the decimal value of the sum of the bits in the Questionable Integrity Signal Condition register.

NOTE

The data in this register is continuously updated and reflects the current conditions.

Mode	All
Remote Command	:STATus:QUESTionable:INTEgrity:SIGNal:CONDition?
Example	STAT:QUES:INT:SIGN:COND?
Preset	0
Status Bits/OPC dependencies	Sequential command
Initial S/W Revision	Prior to A.02.00

Questionable Integrity Signal Enable

This command determines which bits in the Questionable Integrity Signal Condition Register will set bits in the Questionable Integrity Signal Event register, which also sets the Integrity Summary bit (bit 9) in the Questionable Register. The variable <integer> is the sum of the decimal values of the bits you want to enable.

Mode	All
Remote Command	:STATus:QUESTionable:INTEgrity:SIGNal:ENABle <integer> :STATus:QUESTionable:INTEgrity:SIGNal:ENABle?
Example	STAT:QUES:INT:SIGN:ENAB 4 Burst Not Found will be reported to the Integrity Summary of the Status Questionable register.
Preset	32767
Min	0
Max	32767
Status Bits/OPC dependencies	Sequential command
Initial S/W Revision	Prior to A.02.00

Questionable Integrity Signal Event Query

This query returns the decimal value of the sum of the bits in the Questionable Integrity Signal Event register.

NOTE

The register requires that the associated PTR or NTR filters be set before a condition register bit can set a bit in the event register. The data in this register is latched until it is queried. Once queried, the register is cleared.

Mode	All
Remote Command	:STATus:QUESTionable:INTEgrity:SIGNal[:EVENT]?
Example	STAT:QUES:INT:SIGN?
Preset	0
Status Bits/OPC dependencies	Sequential command
Initial S/W Revision	Prior to A.02.00

Questionable Integrity Signal Negative Transition

This command determines which bits in the Questionable Integrity Signal Condition register will set the corresponding bit in the Questionable Integrity Signal Event register when the condition register bit has a negative transition (1 to 0). The variable <integer> is the sum of the decimal values of the bits that you want to enable.

Mode	All
Remote Command	:STATus:QUESTionable:INTEgrity:SIGNal:NTRansition <integer> :STATus:QUESTionable:INTEgrity:SIGNal:NTRansition?
Example	STAT:QUES:INT:SIGN:NTR 4 Burst found will be reported to the Integrity Summary of the Status Questionable register.
Preset	0
Min	0
Max	32767
Status Bits/OPC dependencies	Sequential command
Initial S/W Revision	Prior to A.02.00

Questionable Integrity Signal Positive Transition

This command determines which bits in the Questionable Integrity Signal Condition register will set the corresponding bit in the Questionable Integrity Signal Event register when the condition register bit has a positive transition (0 to 1). The variable <integer> is the sum of the decimal values of the bits that you want to enable.

Mode	All
Remote Command	:STATus:QUEStionable:INTEgrity:SIGNal:PTRansition <integer> :STATus:QUEStionable:INTEgrity:SIGNal:PTRansition?
Example	STAT:QUES:INT:SIGN:PTR 4 Burst not found will be reported to the Integrity Summary of the Status Questionable register.
Preset	32767
Min	0
Max	32767
Status Bits/OPC dependencies	Sequential command
Initial S/W Revision	Prior to A.02.00

Questionable Integrity Uncalibrated Register

"Questionable Integrity Uncalibrated Condition " on page 119

"Questionable Integrity Uncalibrated Enable " on page 119

"Questionable Integrity Uncalibrated Event Query " on page 120

"Questionable Integrity Uncalibrated Negative Transition " on page 120

"Questionable Integrity Uncalibrated Positive Transition " on page 121

Questionable Integrity Uncalibrated Condition

This query returns the decimal value of the sum of the bits in the Questionable Integrity Uncalibrated Condition register.

NOTE

The data in this register is continuously updated and reflects the current conditions.

Mode	All
Remote Command	:STATus:QUEStionable:INTEgrity:UNCalibrated:CONDition?
Example	STAT:QUES:INT:UNC:COND?
Preset	0
Status Bits/OPC dependencies	Sequential command
Initial S/W Revision	Prior to A.02.00

Questionable Integrity Uncalibrated Enable

This command determines which bits in the Questionable Integrity Uncalibrated Condition Register will set bits in the Questionable Integrity Uncalibrated Event register, which also sets the Data Uncalibrated Summary bit (bit 3) in the Questionable Integrity Register. The variable <integer> is the sum of the decimal values of the bits you want to enable.

Mode	All
Remote Command	:STATus:QUEStionable:INTEgrity:UNCalibrated:ENABle :STATus:QUEStionable:INTEgrity:UNCalibrated:ENABle?
Example	STAT:QUES:INT:UNC:ENAB 1 Oversweep (Meas Uncal) will be reported to the Integrity Summary of the Status Questionable register.
Preset	32767
Min	0
Max	32767
Status Bits/OPC dependencies	Sequential command
Initial S/W Revision	Prior to A.02.00

Questionable Integrity Uncalibrated Event Query

This query returns the decimal value of the sum of the bits in the Questionable Integrity Uncalibrated Event register.

NOTE

The register requires that the associated PTR or NTR filters be set before a condition register bit can set a bit in the event register. The data in this register is latched until it is queried. Once queried, the register is cleared.

Mode	All
Remote Command	:STATus:QUEStionable:INTEgrity:UNCalibrated[:EVENT]?
Example	STAT:QUES:INT:UNC?
Preset	0
Status Bits/OPC dependencies	Sequential command
Initial S/W Revision	Prior to A.02.00

Questionable Integrity Uncalibrated Negative Transition

This command determines which bits in the Questionable Integrity Uncalibrated Condition register will set the corresponding bit in the Questionable Integrity Uncalibrated Event register when the condition register bit has a negative transition (1 to 0). The variable <integer> is the sum of the decimal values of the bits that you want to enable.

Mode	All
Remote Command	:STATus:QUEStionable:INTEgrity:UNCalibrated:NTRansition <integer> :STATus:QUEStionable:INTEgrity:UNCalibrated:NTRansition?
Example	STAT:QUES:INT:UNC:NTR 1 Oversweep cleared will be reported to the Integrity Summary of the Status Questionable register.

Preset	0
Min	0
Max	32767
Status Bits/OPC dependencies	Sequential command
Initial S/W Revision	Prior to A.02.00

Questionable Integrity Uncalibrated Positive Transition

This command determines which bits in the Questionable Integrity Uncalibrated Condition register will set the corresponding bit in the Questionable Integrity Uncalibrated Event register when the condition register bit has a positive transition (0 to 1). The variable <integer> is the sum of the decimal values of the bits that you want to enable.

Mode	All
Remote Command	:STATus:QUEStionable:INTEgrity:UNCalibrated:PTRansition <integer> :STATus:QUEStionable:INTEgrity:UNCalibrated:PTRansition?
Example	STAT:QUES:INT:UNC:PTR 1 Oversweep (Meas Uncal) occurred will be reported to the Integrity Summary of the Status Questionable register.
Preset	32767
Min	0
Max	32767
Status Bits/OPC dependencies	Sequential command
Initial S/W Revision	Prior to A.02.00

Questionable Power Register

"Questionable Power Condition " on page 121

"Questionable Power Enable " on page 122

"Questionable Power Event Query " on page 122

"Questionable Power Negative Transition " on page 123

"Questionable Power Positive Transition " on page 123

Questionable Power Condition

This query returns the decimal value of the sum of the bits in the Questionable Power Condition register.

NOTE

The data in this register is continuously updated and reflects the current conditions.

Mode	All
Remote Command	:STATus:QUEStionable:POWer:CONDition?
Example	STAT:QUES:POW:COND?
Preset	0
Status Bits/OPC dependencies	Sequential command
Initial S/W Revision	Prior to A.02.00

Questionable Power Enable

This command determines which bits in the Questionable Power Condition Register will set bits in the Questionable Power Event register, which also sets the Power Summary bit (bit 3) in the Questionable Register. The variable <integer> is the sum of the decimal values of the bits you want to enable.

Mode	All
Remote Command	:STATus:QUEStionable:POWer:ENABle <integer> :STATus:QUEStionable:POWer:ENABle?
Example	STAT:QUES:POW:ENAB 32 50 MHz Input Pwr too High for Cal will be reported to the Power Summary of the Status Questionable register.
Preset	32767
Min	0
Max	32767
Status Bits/OPC dependencies	Sequential command
Initial S/W Revision	Prior to A.02.00

Questionable Power Event Query

This query returns the decimal value of the sum of the bits in the Questionable Power Event register.

NOTE

The register requires that the associated PTR or NTR filters be set before a condition register bit can set a bit in the event register. The data in this register is latched until it is queried. Once queried, the register is cleared.

Mode	All
Remote Command	:STATus:QUEStionable:POWer[:EVENT]?
Example	STAT:QUES:POW?
Preset	0
Status Bits/OPC dependencies	Sequential command
Initial S/W Revision	Prior to A.02.00

Questionable Power Negative Transition

This command determines which bits in the Questionable Power Condition register will set the corresponding bit in the Questionable Power Event register when the condition register bit has a negative transition (1 to 0). The variable <integer> is the sum of the decimal values of the bits that you want to enable.

Mode	All
Remote Command	:STATus:QUEStionable:POWer:NTRansition <integer> :STATus:QUEStionable:POWer:NTRansition?
Example	STAT:QUES:POW:NTR 32 50 MHz Input Power became OK for Cal will be reported to the Power Summary of the Status Questionable register.
Preset	0
Min	0
Max	32767
Status Bits/OPC dependencies	Sequential command
Initial S/W Revision	Prior to A.02.00

Questionable Power Positive Transition

This command determines which bits in the Questionable Power Condition register will set the corresponding bit in the Questionable Power Event register when the condition register bit has a positive transition (0 to 1). The variable <integer> is the sum of the decimal values of the bits that you want to enable.

Mode	All
Remote Command	:STATus:QUEStionable:POWer:PTRansition <integer> :STATus:QUEStionable:POWer:PTRansition?>
Example	STAT:QUES:POW:PTR 32 50 MHz Input Power became too high for Cal will be reported to the Power Summary of the Status Questionable register.
Preset	32767
Min	0
Max	32767
Status Bits/OPC dependencies	Sequential command
Initial S/W Revision	Prior to A.02.00

Questionable Temperature Register

"Questionable Temperature Condition" on page 124

"Questionable Temperature Enable" on page 124

"Questionable Temperature Event Query" on page 124

"Questionable Temperature Negative Transition" on page 125

"Questionable Temperature Positive Transition" on page 125

Questionable Temperature Condition

This query returns the decimal value of the sum of the bits in the Questionable Temperature Condition register.

NOTE

The data in this register is continuously updated and reflects the current conditions.

Mode	All
Remote Command	:STATus:QUESTionable:TEMPerature:CONDition?
Example	STAT:QUES:TEMP:COND?
Preset	0
Status Bits/OPC dependencies	Sequential command
Initial S/W Revision	Prior to A.02.00

Questionable Temperature Enable

This command determines which bits in the Questionable Temperature Condition Register will set bits in the Questionable Temperature Event register, which also sets the Temperature Summary bit (bit 4) in the Questionable Register. The variable <integer> is the sum of the decimal values of the bits you want to enable.

Mode	All
Remote Command	:STATus:QUESTionable:TEMPerature:ENABle <integer> :STATus:QUESTionable:TEMPerature:ENABle?
Example	STAT:QUES:TEMP:ENAB 1 Reference Oscillator Oven Cold will be reported to the Temperature Summary of the Status Questionable register.
Preset	32767
Min	0
Max	32767
Status Bits/OPC dependencies	Sequential command
Initial S/W Revision	Prior to A.02.00

Questionable Temperature Event Query

This query returns the decimal value of the sum of the bits in the Questionable Temperature Event register.

NOTE

The register requires that the associated PTR or NTR filters be set before a condition register bit can set a bit in the event register. The data in this register is latched until it is queried. Once queried, the register is cleared

Mode	All
Remote Command	:STATus:QUEStionable:TEMPerature[:EVENT]?
Example	STAT:QUES:TEMP?
Preset	0
Status Bits/OPC dependencies	Sequential command
Initial S/W Revision	Prior to A.02.00

Questionable Temperature Negative Transition

This command determines which bits in the Questionable Temperature Condition register will set the corresponding bit in the Questionable Temperature Event register when the condition register bit has a negative transition (1 to 0). The variable <integer> is the sum of the decimal values of the bits that you want to enable.

Mode	All
Remote Command	:STATus:QUEStionable:TEMPerature:NTRansition <integer> :STATus:QUEStionable:TEMPerature:NTRansition?
Example	STAT:QUES:TEMP:NTR 1 Reference Oscillator Oven not cold will be reported to the Temperature Summary of the Status Questionable register.
Preset	0
Min	0
Max	32767
Status Bits/OPC dependencies	Sequential command
Initial S/W Revision	Prior to A.02.00

Questionable Temperature Positive Transition

This command determines which bits in the Questionable Temperature Condition register will set the corresponding bit in the Questionable Temperature Event register when the condition register bit has a positive transition (0 to 1). The variable <integer> is the sum of the decimal values of the bits that you want to enable.

Mode	All
Remote Command	:STATus:QUEStionable:TEMPerature:PTRansition <integer> :STATus:QUEStionable:TEMPerature:PTRansition?
Example	STAT:QUES:TEMP:PTR 1 Reference Oscillator Oven became cold will be reported to the

Temperature Summary of the Status Questionable register.	
Preset	32767
Min	0
Max	32767
Status Bits/OPC dependencies	Sequential command
Initial S/W Revision	Prior to A.02.00

IEEE 488.2 Common Commands

The instrument supports the following subset of IEEE 488.2 Common Commands, as defined in Chapter 10 of [IEEE Standard 488.2–1992](#). As indicated in the detailed descriptions, some of these commands correspond directly to instrument front-panel key functionality, while others are available only as remote commands.

Command	Description
*CAL?	Align Now "All (Daily use)" on page 213
*CLS	"Clear Status " on page 129
*ESE	"Standard Event Status Enable " on page 130
*ESE?	
*ESR?	"Standard Event Status Register Query " on page 130
*IDN?	"Identification Query " on page 131
*OPC	"Operation Complete " on page 131
*OPC?	
*OPT?	"Query Instrument Options " on page 132
*RCL	"Recall Instrument State " on page 133
*RST	"*RST (Remote Command Only)" on page 133
*SAV	"Save Instrument State " on page 134
*SRE	"Service Request Enable " on page 134
*SRE?	
*STB?	"Status Byte Query " on page 134
*TRG	"Trigger " on page 135
*TST?	"Self Test Query " on page 135
*WAI	"Wait-to-Continue " on page 135

All (Daily use)

Immediately executes an alignment of all subsystems which includes both the source and the analyzer in the TRX module. The "All" alignment is sufficient to maintain specified performance, provided that (1) the TRX's internal temperature has not drifted more than +/-5 degree C since the previous alignment, and (2) no more than 8 hours have elapsed since the previous "All" alignment., and (3) no more than 1 week has elapsed since these three alignments have all been run: IF, RF, and Source, and (4) a 45 minute warm-up period between power-up of the TRX and invoking the "All" alignment. The instrument stops any measurement currently underway, performs the alignment, then restarts the measurement from the beginning (similar to pressing the Restart key).

If an interfering user signal is present at the RF Input, the alignment is performed on all subsystems except the RF. After completion, the Error Condition message "Align skipped: 50 MHz interference" or "Align

skipped: 4.8 GHz interference” is generated. In addition the Error Condition message “Align Now, RF required” is generated, and bits 11 and 12 are set in the Status Questionable Calibration register.

The query form of the remote commands (:CALibration[:ALL]? or *CAL?) invokes the alignment of all subsystems and returns a success or failure value. An interfering user signal is not grounds for failure; if the alignment was able to succeed on all portions but unable to align the RF because of an interfering signal, the resultant will be the success value.

Successful completion of Align Now, All will clear the “Align Now, All required” Error Condition, and clear bit 14 in the Status Questionable Calibration register. It will also begin the elapsed time counter for Last Align Now, All Time, and capture the Last Align Now, All Temperature.

If the Align RF subsystem succeeded in aligning (no interfering signal present), the elapsed time counter begins for Last Align Now, RF Time, and the temperature is captured for the Last Align Now, RF Temperature. In addition the Error Conditions “Align skipped: 50 MHz interference” and “Align skipped: 4.8 GHz interference” are cleared, the Error Condition “Align Now, RF required” is cleared, and bits 11 and 12 are cleared in the Status Questionable Calibration register

Align Now, All can be interrupted by pressing the Cancel (ESC) front-panel key or remotely with Device Clear followed by the :ABORt SCPI command. When this occurs the Error Condition message “Align Now, All required” is generated, and bit 14 is set in the Status Questionable Condition register. This is because new alignment data may be employed for an individual subsystem, but not a cohesive set of data for all subsystems.

In many cases, you might find it more convenient to change alignments to Normal, instead of executing Align Now, All. When the Auto Align process transitions to Normal, the analyzer will immediately start to update only the alignments that have expired, thus efficiently restoring the alignment process.

NOTE

In EXM/M9420A, Source ARB play will be turned off and the source states will not be restored after Align Now, All.

Key Path	System, Alignments, Align Now
Mode	All
Remote Command	:CALibration[:ALL] :CALibration[:ALL]?
Example	:CAL
Notes	:CALibration[:ALL]? returns 0 if successful :CALibration[:ALL]? returns 1 if failed :CALibration[:ALL]? is the same as *CAL? While Align Now, All is performing the alignment, bit 0 in the Status Operation register is set. Completion, or termination, will clear bit 0 in the Status Operation register. This command is sequential; it must complete before further SCPI commands are processed. Interrupting the alignment from remote is accomplished by invoking Device Clear followed by the :ABORt command. Successful completion will clear bit 14 in the Status Questionable Calibration register. An interfering user signal is not grounds for failure of Align Now, All. However, bits 11 and 12 are set in the Status Questionable Calibration register to indicate Align Now, RF is required.

	An interfering user supplied signal will result in the instrument requiring an Align Now, RF with the interfering signal removed.
Couplings	Initializes the time for the Last Align Now, All Time. Records the temperature for the Last Align Now, All Temperature. If Align RF component succeeded, initializes the time for the Last Align Now, RF Time. If Align RF component succeeded, records the temperature for the Last Align Now, RF Temperature.
Status Bits/OPC dependencies	Bits 11, 12, or 14 may be set in the Status Questionable Calibration register.
Initial S/W Revision	Prior to A.02.00

Mode	All
Remote Command	*CAL?
Example	*CAL?
Notes	*CAL? returns 0 if successful *CAL? returns 1 if failed :CALibration[:ALL]? is the same as *CAL? See additional remarks described with :CALibration[:ALL]? Everything about :CALibration[:ALL]? is synonymous with *CAL? including all conditions, status register bits, and couplings
Initial S/W Revision	Prior to A.02.00

Mode	All
Remote Command	:CALibration[:ALL]:NPENDING
Example	CAL:NPEN
Notes	:CALibration[:ALL]:NPENDING is the same as :CALibration[:ALL] including all conditions, status register bits, except this scpi command does not BLOCK the scpi session, so the user should use status register bits to query if the calibration is successfully completed or not. Typical usage is: 1) :CALibration:ALL:NPENDING (Start a calibration) 2) :STATus:OPERation:CONDition? (Check if the calibration is completed or not, If bit 0 is set, then the system is doing calibration, the user should repeat this scpi query until the bit is cleared) 3):STATus:QUESTionable:CALibration:CONDition? (Check if there are any errors/failures in previous calibration procedure
Initial S/W Revision	X.14.20

Clear Status

Clears the status byte register. It does this by emptying the error queue and clearing all bits in all of the event registers. The status byte register summarizes the states of the other registers. It is also responsible

for generating service requests.

Key Path	No equivalent key. Related key System, Show Errors, Clear Error Queue
Remote Command	*CLS
Example	*CLS Clears the error queue and the Status Byte Register.
Notes	For related commands, see the SYSTem:ERRor[:NEXT]? command. See also the STATus:PRESet command and all commands in the STATus subsystem.
Status Bits/OPC dependencies	Resets all bits in all event registers to 0, which resets all the status byte register bits to 0 also.
Backwards Compatibility Notes	In general the status bits used in the X-Series status system will be backwards compatible with ESA and PSA. However, note that all conditions will generate events that go into the event log, and some will also generate status bits.
Initial S/W Revision	Prior to A.02.00

Standard Event Status Enable

Selects the desired bits from the standard event status enable register. This register monitors I/O errors and synchronization conditions such as operation complete, request control, query error, device dependent error, status execution error, command error, and power on. The selected bits are OR'd to become a summary bit (bit 5) in the byte register which can be queried.

The query returns the state of the standard event status enable register.

Key Path	No equivalent key. Related key System, Show Errors, Clear Error Queue
Remote Command	*ESE <integer> *ESE?
Example	*ESE 36 Enables the Standard Event Status Register to monitor query and command errors (bits 2 and 5). *ESE? Returns a 36 indicating that the query and command status bits are enabled.
Notes	For related commands, see the STATus subsystem and SYSTem:ERRor[:NEXT]? commands.
Preset	255
State Saved	Not saved in state.
Min	0
Max	255
Status Bits/OPC dependencies	Event Enable Register of the Standard Event Status Register.
Initial S/W Revision	Prior to A.02.00

Standard Event Status Register Query

Queries and clears the standard event status event register. (This is a destructive read.) The value returned is a hexadecimal number that reflects the current state (0/1) of all the bits in the register.

Remote Command	*ESR?
Example	*ESR? Returns a 1 if there is either a query or command error, otherwise it returns a zero.
Notes	For related commands, see the STATus subsystem commands.
Preset	0
Min	0
Max	255
Status Bits/OPC dependencies	Standard Event Status Register (bits 0 – 7).
Initial S/W Revision	Prior to A.02.00

Identification Query

Returns a string of instrument identification information. The string will contain the model number, serial number, and firmware revision.

The response is organized into four fields separated by commas. The field definitions are as follows:

- Manufacturer
- Model
- Serial number
- Firmware version

Key Path	No equivalent key. See related key System, Show System.
Remote Command	*IDN?
Example	*IDN? Returns instrument identification information, such as: Keysight Technologies, M9420A, US01020004, M.16.30
Initial S/W Revision	Prior to A.02.00
Modified at S/W Revision	x.14.50

Operation Complete

The *OPC command sets bit 0 in the standard event status register (SER) to “1” when pending operations have finished, that is when all overlapped commands are complete. It does not hold off subsequent operations. You can determine when the overlapped commands have completed either by polling the OPC bit in SER, or by setting up the status system such that a service request (SRQ) is asserted when the OPC bit is set.

The *OPC? query returns a “1” after all the current overlapped commands are complete. So it holds off subsequent commands until the “1” is returned, then the program continues. This query can be used to synchronize events of other instruments on the external bus.

Remote Command	*OPC *OPC?
Example	INIT:CONT 0 Selects single sweeping. INIT:IMM Initiates a sweep. *OPC? Holds off any further commands until the sweep is complete.
Status Bits/OPC dependencies	Not global to all remote ports or front panel. *OPC only considers operation that was initiated on the same port as the *OPC command was issued from. *OPC is an overlapped command, but *OPC? is sequential.
Backwards Compatibility Notes	<ol style="list-style-type: none"> 1. The ESA/PSA/VSA products do not meet all the requirements for the *OPC command specified by IEEE 488.2. This is corrected for X-Series. This will sometimes cause behavior that is not backward compatible, but it will work as customers expect. 2. Commands such as, *OPC/*OPC?/*WAI/*RST used to be global. They considered front panel operation in conjunction with the GPIB functionality. Now they are evaluated on a per channel basis. That is, the various rear panel remote ports and the front panel i/o are all considered separately. Only the functionality initiated on the port where the *OPC was sent, is considered for its operation. 3. *OPC used to hold off until the operation bits were cleared. Now it holds off until all overlapping commands are completed. Also, earlier instruments did not wait for completion of all processes, only the ones identified here (in the STATus:OPERation register): Calibrating: monitored by PSA, ESA, VSA (E4406A) Sweeping: monitored by PSA, ESA, VSA (E4406A) Waiting for Trigger: monitored by PSA, ESA, VSA (E4406A) Measuring: monitored by PSA and ESA (but not in all Modes). Paused: monitored by VSA (E4406A). Printing: monitored by VSA (E4406A). Mass memory busy: monitored by VSA (E4406A).
Initial S/W Revision	Prior to A.02.00

Query Instrument Options

Returns a string of all the installed instrument options. It is a comma separated list with quotes, such as: "503,P03,PFR".

To be IEEE compliant, this command should return an arbitrary ascii variable that would not begin and end with quotes. But the quotes are needed to be backward compatible with previous SA products and software. So, the actual implementation will use arbitrary ascii. But quotes will be sent as the first and last ascii characters that are sent with the comma-separated option list.

Remote Command	*OPT?
Initial S/W Revision	Prior to A.02.00

Recall Instrument State

This command recalls the instrument state from the specified instrument memory register.

- If the state being loaded has a newer firmware revision than the revision of the instrument, no state is recalled and an error is reported
- If the state being loaded has an equal firmware revision than the revision of the instrument, the state will be loaded.
- If the state being loaded has an older firmware revision than the revision of the instrument, the instrument will only load the parts of the state that apply to the older revision.

Remote Command	*RCL <register #>
Example	*RCL 7 Recalls the instrument state that is currently stored in register 7.
Notes	Registers 0 through 6 are accessible from the front panel in menu keys for Recall Registers.
Min	0
Max	127
Status Bits/OPC dependencies	The command is sequential.
Initial S/W Revision	Prior to A.02.00

*RST (Remote Command Only)

*RST is equivalent to :SYST:PRESet:INIT:CONT OFF, which is a Mode Preset in the Single measurement state. This remote command is preferred over Mode Preset remote command - :SYST:PRESet, as optimal remote programming occurs with the instrument in the single measurement state.

Remote Command	*RST
Example	*RST
Notes	Sequential Clears all pending OPC bits and the Status Byte is set to 0.
Couplings	A *RST will cause the currently running measurement to be aborted and cause the default measurement to be active. *RST gets the mode to a consistent state with all of the default couplings set.
Backwards Compatibility Notes	In legacy analyzers *RST did not set the analyzer to Single, but in the X-Series it does, for compliance with the IEEE 488.2 specification. In the X-Series, *RST does not do a *CLS (clear the status bits and the error queue). In legacy analyzers, *RST used to do the equivalent of SYSTem:PRESet, *CLS and INITiate:CONTinuous OFF. But to be 488.2 compliant, *RST in the X-Series does not do a *CLS.
Initial S/W Revision	Prior to A.02.00

Save Instrument State

This command saves the current instrument state and mode to the specified instrument memory register.

Remote Command	*SAV <register #>
Example	*SAV 9 Saves the instrument state in register 9.
Notes	Registers 0 through 6 are accessible from the front panel in menu keys for Save Registers.
Min	0
Max	127
Status Bits/OPC dependencies	The command is sequential.
Initial S/W Revision	Prior to A.02.00

Service Request Enable

This command enables the desired bits of the service request enable register.

The query returns the value of the register, indicating which bits are currently enabled.

Remote Command	*SRE <integer> *SRE?
Example	*SRE 22 Enables bits 1, 2, and 4 in the service request enable register.
Notes	For related commands, see the STATus subsystem and SYSTem:ERRor[:NEXT]? commands.
Preset	0
Min	0
Max	255
Status Bits/OPC dependencies	Service Request Enable Register (all bits, 0 - 7).
Initial S/W Revision	Prior to A.02.00

Status Byte Query

Returns the value of the status byte register without erasing its contents.

Remote Command	*STB?
Example	*STB? Returns a decimal value for the bits in the status byte register. For example, if a 16 is returned, it indicates that bit 5 is set and one of the conditions monitored in the standard event status register is set.
Notes	See related command *CLS.
Status Bits/OPC dependencies	Status Byte Register (all bits, 0 - 7).
Initial S/W Revision	Prior to A.02.00

Trigger

This command triggers the instrument. Use the :TRIGger[:SEQuence]:SOURce command to select the trigger source.

Key Path	No equivalent key. See related keys Single and Restart.
Remote Command	*TRG
Example	*TRG Triggers the instrument to take a sweep or start a measurement, depending on the current instrument settings.
Notes	See related command :INITiate:IMMediate.
Initial S/W Revision	Prior to A.02.00

Self Test Query

This query performs the internal self-test routines and returns a number indicating the success of the testing. A zero is returned if the test is successful, 1 if it fails.

Remote Command	*TST?
Example	*TST? Runs the self-test routines and returns 0=passed, 1=some part failed.
Initial S/W Revision	Prior to A.02.00

Wait-to-Continue

This command causes the instrument to wait until all overlapped commands are completed before executing any additional commands. There is no query form for the command.

Remote Command	*WAI
Example	INIT:CONT OFF; INIT;*WAI Sets the instrument to single sweep. Starts a sweep and waits for its completion.
Status Bits/OPC dependencies	Not global to all remote ports or front panel. *OPC only considers operation that was initiated on the same port as the *OPC command was issued from.
Initial S/W Revision	Prior to A.02.00

4 Input/Output Functions

Input/Output

The Input/Output features are common across multiple Modes and Measurements. These common features are described in this section. See the Measurement description for information on features that are unique.

The Input/Output key accesses the keys that control the Input/Output parameters of the instrument. In general, these are functions associated with external connections to the analyzer, either to the inputs or the outputs. Since these connections tend to be fairly stable within a given setup, in general, the input/output settings do not change when you Preset the analyzer.

Other functions related to the input/output connections, but which tend to change on a measurement by measurement basis, can be found under the Trigger and AMPTD Y Scale keys. In addition, some of the digital I/O bus configurations can be found under the System key.

NOTE

The functions in the Input/Output menu are "global" (common) to all Modes (applications). But individual Input/Output functions only appear in a Mode if they apply to that Mode. Functions that apply to a Mode but not to all measurements in the Mode may be grayed-out in some measurements.

["Input/Output variables - Preset behavior" on page 139](#)

The Input Port selection is the first menu under the Input/Output key:

Key Path	Front-panel key
Remote Command	<code>[:SENSe] :FEED RF AIQ EMIXer</code> <code>[:SENSe] :FEED?</code>
Example	<code>:FEED RF</code> <code>:FEED?</code>
Couplings	The <code>[:SENSe] :FEED RF</code> command turns the calibrator OFF
Preset	This setting is unaffected by a Preset or power cycle. It survives a Mode Preset and mode changes. It is set to RF on a "Restore Input/Output Defaults" or "Restore System Defaults->All"
State Saved	Saved in instrument state
Backwards Compatibility SCPI	<code>[:SENSe] :FEED AREFERENCE</code> In the PSA the calibrator was one of the inputs and selected using the AREF parameter to the same <code>:FEED</code> command that switched the inputs. In the X-Series it is controlled in a separate menu and overrides the input selection. For code compatibility the <code>[:SENSe] :FEED AREFERENCE</code> command is provided, and is aliased to <code>[:SENSe] :FEED :AREF REF50</code> , which causes the input to be switched to the 50 MHz calibrator. The <code>[:SENSe] :FEED RF</code> command switches the input back to the RF port and turns the calibrator OFF, thus providing full compatibility with the PSA calibrator function. Note that after sending this, the query <code>[:SENSe] :FEED?</code> will NOT return "AREF" but instead the currently selected input.
Backwards Compatibility SCPI	<code>[:SENSe] :FEED IQ IONLy QONLy</code> <code>[:SENSe] :FEED?</code> The parameters <code>IQ IONLy QONLy</code> are supported for backwards compatibility with the E44406A. <code>[:SENSe] :FEED IQ</code> aliases to <code>[:SENSe] :FEED :IQ :TYPE IQ</code> <code>[:SENSe] :FEED IONLy</code> aliases to <code>[:SENSe] :FEED :IQ :TYPE IONLy</code>

	<p>[;SENSe]:FEED QONLy aliases to [;SENSe]:FEED:IQ:TYPE QONLy</p> <p>The query [;SENSe]:FEED? will always returns AIQ whatever the type of legacy parameters IQ IONLy QONLy has been used.</p>
Backwards Compatibility Notes	<p>Most of the settings in the X-Series Input/Output system, including External Gain, Amplitude Corrections settings and data, etc., are shared by all modes and are not changed by a mode switch. Furthermore, most variables in the Input/Output system key are not affected by Mode Preset. Both of these behaviors represent a departure from legacy behavior.</p> <p>In the X-Series. Input/Output settings are reset by using the "Restore Input/Output Defaults" function. They can also be reset to their default values through the System->Restore System Defaults-> In/Out Config key or through the System ->Restore System Defaults -> All key (and corresponding SCPI).</p> <p>While this matches most use cases better, it does create some code compatibility issues. For example, Amplitude Corrections are no longer turned off by a Mode Preset, but instead by using the "Restore Input/Output Defaults" key/SCPI.</p> <p>Although Input/Output settings are not part of each Mode's State, they are saved in the Save State files, so that all of the instrument settings can be recalled with Recall State, as in legacy instruments.</p>
Initial S/W Revision	Prior to A.02.00
Remote Command	<p>:INPut:MIXer EXTernal INTernal</p> <p>:INPut:MIXer?</p>
Example	<p>INP:MIX INT</p> <p>INP:MIX?</p>
Notes	<p>In legacy analyzers you choose between the Internal mixer or an External Mixer. In the X-Series, the External Mixer is one of the choices for the Input and is selected using the FEED command (:SENSe:FEED EXTMIxer).</p> <p>For compatibility, the INPut:MIXer EXTernal INTernal legacy command is mapped as follows:</p> <ol style="list-style-type: none"> 1. When INPut:MIXer EXTernal is received, SENSe:FEED EMIXer is executed. 2. When INPut:MIXer INTernal is received, SENSe:FEED RF is executed. 3. When INPut:MIXer? is received, the response will be INT if any input other than the external mixer is selected and EXT if the external mixer is selected
Preset	INT
Backwards Compatibility Notes	<p>PSA supports the following SCPI Command :</p> <p>:INPut:MIXer:TYPE PRESelected UNPReselect</p> <p>:INPut:MIXer:TYPE?</p> <p>PXA does not support the :INPut:MIXer:TYPE command.</p>
Initial S/W Revision	A.08.01

Input/Output variables - Preset behavior

Virtually all the input/output settings are NOT a part of mode preset. They can be set to their default value

by one of the three ways:

- by using the Restore Input/Output Defaults key on the first page of the input/output menu,
- by using the System->Restore System Defaults->Input/Output Settings or,
- by using the System -> Restore System Defaults->All. Also, they survive a Preset and a Power cycle.

A very few of the Input/Output settings do respond to a Mode Preset; for example, if the Calibrator is on it turns off on a Preset, and if DC coupling is in effect it switches to AC on a Preset. These exceptions are made in the interest of reliability and usability, which overrides the need for absolute consistency. Exceptions are noted in the SCPI table for the excepted functions.

RF Input

Selects the front-panel RF input port to be the analyzer signal input. If RF is already selected, pressing this key accesses the RF input setup functions.

Key Path	Input/Output
Example	[:SENSe]:FEED RF
Couplings	The act of connecting the U7227A USB Preamplifier to one of the analyzer's USB ports will cause the Input to automatically switch to the RF Input. If the RF Calibrator is on, it is turned off. Subsequently disconnecting the USB Preamp from USB does not change the Input selection nor restore the previous selection.
Readback	The RF input port, RF coupling, and current input impedance settings appear on this key as: "XX, YY, ZZ" where XX is RF, RF2, RFIO1, RFIO2, depending on what input is selected (only appears on analyzers with multiple RF inputs) YY is AC or DC ZZ is 50Ω or 75Ω
Initial S/W Revision	Prior to A.02.00
Modified at S/W Revision	A.14.00

Input Z Correction

Sets the input impedance for unit conversions. This affects the results when the y-axis unit is voltage or current units (dBmV, dBμV, dBμA, V, A), but not when it is power units (dBm, W). The impedance you select is for computational purposes only, since the actual impedance is set by internal hardware to 50 ohms. Setting the computational input impedance to 75 ohms is useful when using a 75 ohm to 50 ohm adapter to measure a 75 ohm device on an analyzer with a 50 ohm input impedance.

There are a variety ways to make 50 to 75 ohm transitions, such as impedance transformers or minimum loss pads. The choice of the solution that is best for your measurement situation requires balancing the amount of loss that you can tolerate with the amount of measurement frequency range that you need. If you are using one of these pads/adaptors with the Input Z Corr function, you might also want to use the Ext Gain key. This function is used to set a correction value to compensate for the gain (loss) through your pad. This correction factor is applied to the displayed measurement values.

Key Path	Input/Output, RF Input
Remote Command	<code>[:SENSe] :CORRection:IMPedance [:INPut] [:MAGNitude] 50 75</code> <code>[:SENSe] :CORRection:IMPedance [:INPut] [:MAGNitude] ?</code>
Example	CORR:IMP 75 sets the input impedance correction to 75 ohms. CORR:IMP?
Preset	This is unaffected by a Preset but is set to 50 ohms on a "Restore Input/Output Defaults" or "Restore System Defaults->All" Some instruments/options may have 75 ohms available.
State Saved	Saved in instrument state
Readback	50 Ω or 75 Ω . Current setting reads back to the RF key.
Initial S/W Revision	Prior to A.02.00

RF Input Port

Specifies the RF input port used. The RF Input Port key only appears on units with multiple inputs, and lets you switch between the two inputs.

Switching from the RF input port to one of the RFIO ports, on units that have them, changes the receiver performance of the instrument.

Key Path	Input/Output, RF Input
Remote Command	<code>[:SENSe] :FEED:RF:PORT [:INPut] RFIN RFIN2 RFIO1 RFIO2 RFIO3 RFIO4 RFHD RFFD</code> <code>[:SENSe] :FEED:RF:PORT [:INPut] ?</code>
Example	:FEED:RF:PORT RFIN
Dependencies	This key only appears in models that support multiple inputs. If the SCPI command is sent with unsupported parameters in any other model, an error is generated, -221.1900, "Settings conflict;option not installed" When any input is selected in a measurement that does not support it, the "No result; Meas invalid with this input" error condition occurs, and the measurement returns invalid data when queried. RFHD and RFFD are only available on M9420A, option "HDX" is required to enable RFHD port and option "FDX" is required to enable RFFD port.
Preset	This is unaffected by Mode Preset but is set to RF on a "Restore Input/Output Defaults" or "Restore System Defaults -> All"
State Saved	Saved in instrument state
Readback	The current RF Input Port selected is read back to this key
Backwards Compatibility SCPI	<code>INPut<1 2>:TYPE INPUT1 INPUT2</code> <code>INPut<1 2>:TYPE?</code> Included for R&S ESU compatibility. In the MXE, the INPUT1 parameter is aliased to RFIN and the INPUT2 parameter is aliased to RFIN2

Initial S/W Revision	A.05.01
Modified at S/W Revision	A.14.00

RF Input

Specifies using the main RF port for the current measurement

Key Path	Input/Output, RF Input, RF Input Port
Example	:FEED:RF:PORT RFIN
ReadBack	RF Input
Initial S/W Revision	A.05.01
Modified at S/W Revision	A.14.00

External Gain

Compensates for gain or loss in the measurement system outside the spectrum analyzer. The External Gain is subtracted from the amplitude readout (or the loss is added to the amplitude readout). So, the displayed signal level represents the signal level at the output of the device-under-test, which can be the input of an external device that provides gain or loss.

Entering an External Gain value does not affect the Reference Level, therefore the trace position on screen changes, as do all of the values represented by the trace data. Thus, the values of exported trace data, queried trace data, marker amplitudes, trace data used in calculations such as N dB points, trace math, peak threshold, etc., are all affected by External Gain. Changing the External Gain, even on a trace that is not updating, will immediately change all of the above, without new data needing to be taken.

NOTE

Changing the External Gain causes the analyzer to immediately stop the current sweep and prepare to begin a new sweep. The data will not change until the trace data updates because the offset is applied to the data as it is taken. If a trace is exported with a nonzero External Gain, the exported data will contain the trace data with the offset applied.

In the Spectrum Analyzer mode, a Preamp is the common external device providing gain or loss. In a measurement application mode like GSM or W-CDMA, the gain or loss could be from a BTS (Base Transceiver Station) or an MS (Mobile Station). So in the Spectrum Analyzer mode MS and BTS would be grayed out and the only choice would be Ext Preamp. Similarly in some of the digital communications applications, Ext Preamp will be grayed out and you would have a choice of MS or BTS.

Key Path	Input/Output
Couplings	The Ext Preamp, MS, and BS keys may be grayed out depending on which measurement is currently selected. If any of the grayed out keys are pressed, or the equivalent SCPI command is sent, an advisory message is generated.
Readback	1-of-N selection [variable]
Initial S/W Revision	Prior to A.02.00

Ext Preamp

This function is similar to the reference level offset function. Both affect the displayed signal level. Ref Lvl Offset is a mathematical offset only, no analyzer configuration is affected. Ext Preamp gain is used when determining the auto-coupled value of the Attenuator. The External Gain value and the Maximum Mixer Level settings are both part of the automatic setting equation for the RF attenuation setting. (10 dB of Attenuation is added for every 10 dB of External Gain.)

Note that the Ref Lvl Offset and Maximum Mixer Level are described in the Amplitude section. They are reset by the instrument Preset. The External Preamp Gain is reset by the "Restore Input/Output Defaults" or "Restore System Defaults->All functions. . The External Gain is subtracted from the amplitude readout so that the displayed signal level represents the signal level at the output of the device-under-test, which is the input of the external device that is providing gain or loss.

"More Information" on page 143

Key Path	Input/Output, External Gain
Remote Command	<code>[:SENSe] :CORRection:SA[:RF]:GAIN <rel_ampl></code> <code>[:SENSe] :CORRection:SA[:RF]:GAIN?</code>
Example	CORR:SA:GAIN 10 sets the Ext Gain value to 10 dB CORR:SA:GAIN -10 sets the Ext Gain value to -10 dB (that is, an attenuation of 10 dB)
Notes	Does not auto return.
Dependencies	The reference level limits are determined in part by the External Gain/Atten, Max Mixer Level, and RF Atten. This key is grayed out in Modes that do not support External Gain
Preset	This is unaffected by Preset but is set to 0 dB on a "Restore Input/Output Defaults" or "Restore System Defaults->All"
State Saved	Saved in instrument state
Min	-120 dB
Max	120 dB
Readback	Preamp Gain, <Ext Gain value> dB
Backwards Compatibility SCPI	<code>[:SENSe] :CORRection:OFFSet[:MAGNitude]</code> The legacy "Ext Preamp Gain" key is now called "Ext Gain" and the sub-menu has choices of Ext Preamp MS BTS for backwards compatibility.
Initial S/W Revision	Prior to A.02.00
Modified at S/W Revision	A.14.00

More Information

The U7227A USB Preamplifier is an accessory for the X-Series Signal Analyzer that provides gain externally, and whose gain settings are automatically loaded into the analyzer over USB whenever it is connected to one of the analyzer's USB ports.

While the USB Preamplifier is plugged into one of the analyzer's USB ports, the analyzer will consider it to be in the signal path of the RF Input and will apply the calibration data from the USB Preamp to measurements taken at the RF Input (on 2 input boxes, it will be considered to be in the signal path of RF Input 1; it is not supported for RF Input 2).

The USB Preamplifier contains its own cal data. This includes a noise trace suitable for use with NFE, for those models which support NFE. The act of connecting the Preamp to USB will cause the cal data to be downloaded from the preamp. When this happens an informational message is provided saying "Cal data loaded from USB Preamp". The analyzer will then automatically apply the calibration factors loaded from the Preamp in any measurement that supports the USB Preamp.

The External Preamp Gain setting may still be used, even though it is not required for the USB Preamp (since the USB Preamp supplies its own gain data to the analyzer which is applied automatically). Connecting the USB Preamp does not change the External Preamp Gain setting, however unless you have another gain or attenuation element in the signal path, the appropriate setting for External Preamp Gain is 0 dB.

Overload detection and reporting will apply when the USB preamplifier is connected to USB. The USB Preamplifier has its own overload detector which reports overloads to the instrument over USB. This generates an error condition, "Input Overload;USB Preamp."

If, while the USB Preamp is connected to USB, a measurement is selected that does not support the USB preamplifier, the "No result; Meas invalid with Preamp" error condition is generated.

MS

Sets an external gain/attenuation value for MS (Mobile Station) tests.

Key Path	Input/Output, External Gain
Remote Command	[:SENSE] :CORRection:MS[:RF]:GAIN <rel_ampl> [:SENSe] :CORRection:MS[:RF]:GAIN?
Example	CORR:MS:GAIN 10 sets the Ext Gain value to 10 dB CORR:MS:GAIN -10 sets the Ext Gain value to -10 dB (that is, a loss of 10 dB.)
Notes	Does not auto return.
Dependencies	The reference level limits are determined in part by the External Gain, Max Mixer Level, RF Atten This key is grayed out in modes that do not support MS.
Preset	This is unaffected by a Preset but is set to 0 dB on a "Restore Input/Output Defaults" or "Restore System Defaults->All"
State Saved	Saved in instrument state.
Min	-100 dB
Max	100 dB
Readback	MS, <Ext Gain value> dB
Initial S/W Revision	Prior to A.02.00

Remote Command	[:SENSe] :CORRection:MS[:RF]:LOSS <rel_ampl>
-----------------------	--

	<code>[:SENSe] :CORRection:MS [:RF] :LOSS?</code>
Example	<code>CORR:MS:LOSS 10</code> sets the Ext Gain value to -10 dB, and subsequently querying <code>:LOSS</code> will give 10 dB <code>CORR:MS:LOSS -10</code> sets the Ext Gain value to 10 dB, and subsequently querying <code>:LOSS</code> will give -10 dB
Notes	A positive value of <code><rel_ampl></code> in the above command means a loss and a negative value indicates a gain. Anytime <code>:LOSS</code> is set it sets <code>:GAIN</code> to the negative value of the parameter sent. Anytime <code>:LOSS</code> is queried it gives the negative of <code>:GAIN</code>
Preset	This is unaffected by a Preset but is set to 0 dB on a "Restore Input/Output Defaults" or "Restore System Defaults->All"
Min	100 dB
Max	-100 dB
Initial S/W Revision	Prior to A.02.00

BTS

Sets an external attenuation value for BTS (Base Transceiver Station) tests.

Key Path	Input/Output, External Gain
Remote Command	<code>[:SENSe] :CORRection:BTS [:RF] :GAIN <rel_ampl></code> <code>[:SENSe] :CORRection:BTS [:RF] :GAIN?</code>
Example	<code>CORR:BTS:GAIN 10</code> sets the Ext Gain value to 10 dB <code>CORR:BTS:GAIN -10</code> sets the Ext Gain value to -10 dB (that is, a loss of 10 dB.)
Notes	Does not auto return.
Dependencies	The reference level limits are determined in part by the External Gain, Max Mixer Level, RF Atten This key is grayed out in modes that do not support BTS.
Preset	This is unaffected by a Preset but is set to 0 dB on a "Restore Input/Output Defaults" or "Restore System Defaults->All"
State Saved	Saved in instrument state.
Min	-100 dB
Max	100 dB
Readback	BTS, <code><Ext Gain value></code> dB
Initial S/W Revision	Prior to A.02.00

Remote Command	<code>[:SENSe] :CORRection:BTS [:RF] :LOSS <rel_ampl></code> <code>[:SENSe] :CORRection:BTS [:RF] :LOSS?</code>
Example	<code>CORR:BTS:LOSS 10</code> sets the Ext Gain value to -10 dB, and subsequently querying <code>:LOSS</code> will give 10

	dB CORR:BTS:LOSS -10 sets the Ext Gain value to 10 dB, and subsequently querying :LOSS will give -10 dB
Notes	A positive value of <rel_ampl> in the above command means a loss and a negative value indicates a gain. Anytime :LOSS is set it sets :GAIN to the negative value of the parameter sent. Anytime :LOSS is queried it gives the negative of :GAIN
Preset	This is unaffected by a Preset but is set to 0 dB on a "Restore Input/Output Defaults" or "Restore System Defaults->All"
Min	100 dB
Max	-100 dB
Initial S/W Revision	Prior to A.02.00

Restore Input/Output Defaults

This selection causes the group of settings and data associated with the Input/Output key to be a reset to their default values. In addition, when a Source is installed, licensed and selected, Restore Input/Output defaults will initiate a Source Preset.

This level of Restore System Defaults does not affect any other system settings or mode settings and does not cause a mode switch. All the features described in this section are reset using this key, including Input Corrections and Data (described in the Corrections section).

Key Path	Input/Output
Example	:SYST:DEF INP presets all the Input/Output variables to their factory default values.
Notes	Refer to the Utility Functions for information about Restore System Defaults and the complete description of the :SYSTem:DEfault INPut: command.
Initial S/W Revision	Prior to A.02.00

Data Source

Gives you the choice of either using a hardware input signal as the input or raw data stored in a data storage buffer from an earlier acquisition. You can also share raw data across certain measurements that support this feature. The measurements must be capable of storing raw data. There are three choices under this menu. You can select "Inputs" which is the same as selecting one of the inputs from the input port, for example RF, AREF, I/Q, or IFAlign. Selecting "Capture Buffer" allows you to use data that has been stored earlier in the same measurement or from a previous measurement using the "Current Meas -> Capture Buffer" feature. Selecting "Recorded Data" allows you to playback long data capture records stored in the record buffer.

Key Path	Input/Output
Remote Command	[:SENSe] :FEED:DATA INPut STORed [:SENSe] :FEED:DATA?

Example	FEED:DATA STOR FEED:DATA?
Notes	INPut = Inputs STORed = Capture Buffer
Dependencies	Not all inputs are available in all modes. Unavailable keys are grayed out.
Preset	This is unaffected by Preset but is set to INPut on a "Restore Input/Output Defaults" or "Restore System Defaults->All"
State Saved	Saved in instrument state
Readback	Variable
Backwards Compatibility SCPI	[:SENSe] :FEED:SOURce INPut STORed [:SENSe] :FEED:SOURce?
Initial S/W Revision	Prior to A.02.00

Inputs

Sets the measurement to use the input selections (RF, AREF, I/Q)

Key Path	Input/Output, Data Source
Example	FEED:DATA INP causes the measurement to look at the input selection
Notes	Does not auto return.
Readback	Inputs
Initial S/W Revision	Prior to A.02.00

Capture Buffer

Some WCDMA and demod measurements support this feature. This allows sharing of the raw data across certain measurements. If you want to make another measurement on the same signal, you would store that raw data using the "Current Meas -> Capture Buffer" key. Then the data is available for the next measurement to use. You must have raw data stored in the instrument memory before the Capture Buffer choice is available for use.

Key Path	Input/Output, Data Source
Example	FEED:DATA STOR causes stored measurement data to be used with a different measurement that supports this.
Notes	Does not auto return. This key is grayed out when you switch to a measurement that does not support this feature.
Dependencies	If you switch to a measurement that does not support this feature, then the instrument switches to

	use "Inputs" and grays out this key. If the grayed out key is pressed, it generates a message.
Readback	Stored Data
Initial S/W Revision	Prior to A.02.00

Current Meas -> Capture Buffer

Pressing this key stores the raw data of one measurement in the internal memory of the instrument where it can then be used by a different measurement by pressing "Stored Data". When raw data is stored, then the data source selection switch automatically changes to "Stored Data". Stored raw data cannot be directly accessed by a user. There is no save/recall function to save the raw data in an external media. However if you want to get the stored raw data, you must first perform a measurement using the stored raw data. Now you can access the used raw data, which is the same as stored raw data, using the FETch or READ commands.

Key Path	Input/Output, Data Source
Remote Command	[:SENSe] :FEED:DATA:STORe
Example	FEED:DATA:STOR stores recorded data
Notes	This is command only, there is no query
Dependencies	Grayed out in the SA measurement.
Backwards Compatibility SCPI	[:SENSe] :FEED:SOURce:STORe
Initial S/W Revision	Prior to A.02.00

Freq Ref In

Specifies the frequency reference as being the internal reference at the rear panel input labeled EXT REF IN, a 1 pulse per second signal at the EXT REF IN input,, external reference or sensing the presence of a signal at the EXT REF IN input.

When the frequency reference is set to internal, the internal 10 MHz reference is used even if an external reference is connected.

When the frequency reference is set to external, the instrument will use the external reference. However, if there is no external signal present, or it is not within the proper amplitude range, a condition error message is generated. When the external signal becomes valid, the error is cleared.

When the frequency reference is set to Pulse, the instrument expects a 1 pulse per second signal at the EXT REF IN input. The instrument uses this signal to adjust the frequency of the internal reference.

If Sense is selected, the instrument checks whether a signal is present at the external reference connector. If it senses a signal within 5 ppm of the External Ref Freq (as set on the External Ref Freq softkey), it will automatically switch to the external reference. If it senses a 1 pulse per second signal, it enters Pulse mode, wherein the signal is used to adjust the internal reference. When no signal is present, it automatically switches to the internal reference. No message is generated as the reference switches between pulse, external and internal. The monitoring of the external reference occurs approximately on 1

millisecond intervals, and never occurs in the middle of a measurement acquisition, only at the end of the measurement (end of the request).

If for any reason the instrument's frequency reference is not able to obtain lock, Status bit 1 in the Questionable Frequency register will be true and a condition error message is generated. When lock is regained, Status bit 1 in the Questionable Frequency register will be cleared and the condition error will be cleared.

If an external frequency reference is being used, you must enter the frequency of the external reference if it is not exactly 10 MHz. The External Ref Freq key is provided for this purpose.

NOTE:

A common frequency reference module serves all instrument instances, but only one instance of the software application can change the reference input type (INT or EXT or SENSE). The software application allowed to change the reference input is called the controlling instance; by default, the left most instrument instance is the controlling instance. This can be changed in the config file "E66XXModules.config" located under the folder E:\Agilent\Instrument. For the non-controlling instance (s) the reference input types (in SCPI commands, and in the Virtual Front Panel menus) are blanked and unavailable for use.

On M9420A module, there is no internal frequency reference. To work correctly, a 100MHz external frequency reference signal is needed to connect to the front panel of the module. The default Freq Ref In setting is "External" and it cannot be set to any other types.

Key Path	Input/Output
Remote Command	<code>[:SENSe]:ROSCillator:SOURce:TYPE INTernal EXTernal SENSe PULSe</code> <code>[:SENSe]:ROSCillator:SOURce:TYPE?</code>
Dependencies	The PULSe parameter, and support of the 1 pps signal at the EXT REF IN input, are not available in firmware prior to A.13.00. They are also not available in some model numbers. If not available, the Pulse key will be blank, and sending the PULSe parameter via SCPI will generate an error. M9420A is only support EXTernal type.
Preset	This is unaffected by a Preset but is set to EXTernal for M9420A or SENSe for other models on a "Restore Input/Output Defaults" or "Restore System Defaults->All".
State Saved	Saved in instrument state.
Status Bits/OPC dependencies	STATus:QUEStionable:FREQUency bit 1 set if unlocked. Note: The status bit is not set for non-controlling instances. To determine if the frequency reference is unlocked, the controlling instance must be queried.
Backwards Compatibility Notes	Freq Ref In was not saved in state in the legacy instruments. It is a part of state in the X-Series.
Initial S/W Revision	Prior to A.02.00
Modified at S/W Revision	A.14.00

Remote Command	<code>[:SENSe]:ROSCillator:SOURce?</code>
Notes	The query <code>[SENSe]:ROSCillator:SOURce?</code> returns the current switch setting. This means: 1. If it was set to SENSe but there is no external reference nor 1 pps signal so the instrument is

	<p>actually using the internal reference, then this query returns INTernal and not SENSE.</p> <ol style="list-style-type: none"> 2. If it was set to SENSE and there is an external reference present, the query returns EXTernal and not SENSE. 3. If it was set to SENSE and there is a 1 pps signal present, the query returns PULSe and not SENSE. 4. If it was set to EXTernal, then the query returns "EXTernal" 5. If it was set to INTernal, then the query returns "INTernal". 6. If it was set to PULSe, then the query returns "PULSe" <p>Note: The SCPI query always returns "INTernal" for non-controlling instances. M9420A is only supported EXTernal type.</p>
Preset	<p>All other models: SENSe M9420A: EXTernal</p>
Backwards Compatibility Notes	<p>The query [:SENSe]:ROSCillator:SOURce? was a query-only command in ESA which always returned whichever reference the instrument was using. The instrument automatically switched to the ext ref if it was present.</p> <p>In PSA (which had no sensing) the command [:SENSe]:ROSCillator:SOURce set the reference (INT or EXT), so again its query returned the actual routing.</p> <p>Thus the query form of this command is 100% backwards compatible with both instruments.</p>
Initial S/W Revision	Prior to A.02.00

Remote Command	<code>[:SENSe]:ROSCillator:SOURce INTernal EXTernal</code>
Notes	<p>For PSA compatibility the command form is provided and is directly mapped to [:SENSe]:ROSCillator:SOURce:TYPE</p> <p>Note: The SCPI command does nothing for non-controlling instances.</p>
Initial S/W Revision	Prior to A.02.00

External

The external reference is used.

Key Path	Input/Output, Freq Ref In
Example	:ROSC:SOUR:TYPE EXT
Readback	External
Initial S/W Revision	Prior to A.02.00

Ext Ref Freq

This key tells the analyzer the frequency of the external reference. When the external reference is in use (either because the reference has been switched to External or because the Reference has been switched

to Sense and there is a valid external reference present) this information is used by the analyzer to determine the internal settings needed to lock to that particular external reference signal.

For the instrument to stay locked, the value entered must be within 5 ppm of the actual external reference frequency. So it is important to get it close, or you risk an unlock condition.

Note that this value only affects the instrument's ability to lock. It does not affect any calculations or measurement results. See "Freq Offset" in the Frequency section for information on how to offset frequency values.

Key Path	Input/Output, Freq Ref In
Remote Command	[:SENSE] :ROSCillator:EXTernal:FREQuency <freq> [:SENSE] :ROSCillator:EXTernal:FREQuency?
Example	ROSC:EXT:FREQ 20 MHz sets the external reference frequency to 20 MHz, but does not select the external reference. ROSC:SOUR:TYPE EXT selects the external reference.
Dependencies	Still available with Internal or Pulse selected, to allow setup for when External is in use. However, the setting has no effect if the Internal Reference is in use (Freq Ref In set to Internal, Pulse, or SENSE:INT or SENSE:PULSE).
Preset	This is unaffected by a Preset but is set to 10 MHz on a "Restore Input/Output Defaults" or "Restore System Defaults->All"
Min	M9420A:100 MHz
Max	M9420A:100 MHz
Default Unit	Hz
Initial S/W Revision	Prior to A.02.00
Modified at S/W Revision	A.14.00

RF Output & Test Set Config

The RF Output & Test Set Config key allows you to set the RF Output Port and multipoint adapter unit which is connected to the instrument by USB for download of calibration data and additional control.

This menu also allows you to set Trigger Config which is used to set the input/output type of the 4 Bi-directional Trigger ports.

Key Path	Input/Output
Preset	All settings under this key are returned to their default state when Restore Input/Output Defaults is pressed.
State Saved	Saved in State
Initial S/W Revision	A.09.49

RF Output

Specifies the RF Output Port used.

Switching from the RF Output port to one of the RFIO ports changes the transmitter performance of the instrument.

Key Path	Input/Output, RF Output & Test Set Config
Remote Command	[:SENSe] :FEED:RF:PORT:OUTPut RFOut RFIO1 RFIO2 GPSout GNSSout RFIO3 RFIO4 RFHD RFFD [:SENSe] :FEED:RF:PORT:OUTPut?
Example	:FEED:RF:PORT:OUTP RFIO1
Dependencies	RFHD and RFFD are only available on M9420A, option "HDX" is required to enable RFHD port and option "FDX" is required to enable RFFD port.
Preset	This is unaffected by Mode Preset but is set to RFOut on a "Restore Input/Output Defaults" or "Restore System Defaults -> All"
State Saved	Saved in State
Readback	The current RF Output Port selected is read back to this key
Initial S/W Revision	A.05.01
Modified at S/W Revision	A.14.00

RF Output

The RF port that will be used for the current output.

Key Path	Input/Output, RF Output & Test Set Config, RF Output
Example	:FEED:RF:PORT:OUTP RFO
ReadBack	RF Output
Initial S/W Revision	A.05.01
Modified at S/W Revision	A.14.00

Output Config

Accesses keys that configure various output settings, like the frequency reference output, trigger output and analog output.

Key Path	Input/Output
Backwards Compatibility Notes	In ESA there was not a user interface to enable the Video Output (Analog Output), Trigger Output, or Gate Output. In the X-Series each of these physical connectors requires configuration, thus the user interface has been added for X-Series, along with the potential for an output you think is always on to be switched off.
Initial S/W Revision	Prior to A.02.00

Trig Out

Select the type of output signal that will be output from the Trig 1 Out, or Trig 2 Out connectors.

Key Path	Input/Output, Output Config
Remote Command	:TRIGger TRIGger1 TRIGger2[:SEquence]:OUTPut HSWP MEASuring MAIN GATE GTRigger OEVEN SPOint SSWeep SSEttled S1Marker S2Marker S3Marker S4Marker OFF :TRIGger TRIGger1 TRIGger2[:SEquence]:OUTPut?
Example	TRIG:OUTP HSWP TRIG2:OUTP GATE
Dependencies	The second Trigger output (Trig 2 Out) does not appear in all models; in models that do not support it, the Trig 2 Out key is blanked, and sending the SCPI command for this output generates an error, "Hardware missing; Not available for this model number" In models that do not support the Trigger 2 output, this error is returned if trying to set Trig 2 Out and a query of Trig 2 Out returns OFF.
Preset	Trigger 1: Sweeping (HSWP) Trigger 2: Gate This is unaffected by a Preset but is preset to the above values on a "Restore Input/Output Defaults" or "Restore System Defaults->All"
State Saved	Saved in instrument state
Initial S/W Revision	Prior to A.02.00

Polarity

Sets the output to the Trig 1 Out, or Trig 2 Out, connector to trigger on either the positive or negative polarity.

Key Path	Input/Output, Output Config, Trig 1/2 Output
Remote Command	:TRIGger TRIGger1 TRIGger2[:SEquence]:OUTPut:POLarity POSitive NEGative :TRIGger TRIGger1 TRIGger2[:SEquence]:OUTPut:POLarity?
Example	TRIG1:OUTP:POL POS
Preset	This is unaffected by a Preset but is set to POSitive on a "Restore Input/Output Defaults" or "Restore System Defaults->All"
State Saved	Saved in instrument state
Initial S/W Revision	Prior to A.02.00

Off

Selects no signal to be output to the Trig 1 Out, or Trig 2 Out, connector.

Key Path	Input/Output, Output Config, Trig 1/2 Output
Example	TRIG1:OUTP OFF
Readback	Off
Initial S/W Revision	Prior to A.02.00

Sweeping (HSWP)

Selects the Sweeping Trigger signal to be output to the Trig 1 Out, or Trig 2 Out, connector when a measurement is made. This signal has historically been known as "HSWP" (High = Sweeping), and is 5 V TTL level with 50 ohm output impedance.

Key Path	Input/Output, Output Config, Trig 1/2 Output
Example	TRIG1:OUTP HSWP
Readback	Sweeping
Initial S/W Revision	Prior to A.02.00

Measuring

Selects the Measuring trigger signal to be output to the Trig 1 Out, or Trig 2 Out, connector. This signal is true while the Measuring status bit is true.

Key Path	Input/Output, Output Config, Trig 1/2 Output
Example	TRIG1:OUTP MEAS
Readback	Measuring
Initial S/W Revision	Prior to A.02.00

Main Trigger

Selects the current instrument trigger signal to be output to the Trig 1 Out, or Trig 2 Out, connector.

Key Path	Input/Output, Output Config, Trig 1/2 Output
Example	TRIG1:OUTP MAIN
Readback	Main Trigger
Initial S/W Revision	Prior to A.02.00

Gate Trigger

Selects the gate trigger signal to be output to the Trig 1 Out, or Trig 2 Out, connector. This is the source of the gate timing, not the actual gate signal.

Key Path	Input/Output, Output Config, Trig 1/2 Output
Example	TRIG1:OUTP GTR
Readback	Gate Trigger
Initial S/W Revision	Prior to A.02.00

Gate

Selects the gate signal to be output to the Trig 1 Out, or Trig 2 Out, connector. The gate signal has been delayed and its length determined by delay and length settings. When the polarity is positive, a high on the Trig 1 Out, or Trig 2 Out, represents the time the gate is configured to pass the signal.

Key Path	Input/Output, Output Config, Trig 1/2 Output
Example	TRIG1:OUTP GATE
Readback	Gate
Initial S/W Revision	Prior to A.02.00

Odd/Even Trace Point

Selects either the odd or even trace points as the signal to be output to the Trig 1 Out, or Trig 2 Out, connector when performing swept spectrum analysis. When the polarity is positive, this output goes high during the time the analyzer is sweeping past the first point (Point 0) and every other following trace point. The opposite is true if the polarity is negative.

Key Path	Input/Output, Output Config, Trig 1/2 Output
Example	TRIG1:OUTP OEV
Readback	Odd/Even
Initial S/W Revision	Prior to A.02.00

Trig Out

Select the type of output signal that will be output from the Trig 1 Out, or Trig 2 Out connectors.

Key Path	Input/Output, Output Config
Remote Command	:TRIGger TRIGger1 TRIGger2[:SEquence]:OUTPut HSWP MEASuring MAIN GATE GTRigger OEVEN SPOint SSWeep SSEtTled S1Marker S2Marker S3Marker S4Marker OFF :TRIGger TRIGger1 TRIGger2[:SEquence]:OUTPut?
Example	TRIG:OUTP HSWP TRIG2:OUTP GATE
Dependencies	The second Trigger output (Trig 2 Out) does not appear in all models; in models that do not support it, the Trig 2 Out key is blanked, and sending the SCPI command for this output generates an error,

	"Hardware missing; Not available for this model number" In models that do not support the Trigger 2 output, this error is returned if trying to set Trig 2 Out and a query of Trig 2 Out returns OFF.
Preset	Trigger 1: Sweeping (HSWP) Trigger 2: Gate This is unaffected by a Preset but is preset to the above values on a "Restore Input/Output Defaults" or "Restore System Defaults->All"
State Saved	Saved in instrument state
Initial S/W Revision	Prior to A.02.00

Off

Selects no signal to be output to the Trig 1 Out, or Trig 2 Out, connector.

Key Path	Input/Output, Output Config, Trig 1/2 Output
Example	TRIG1:OUTP OFF
Readback	Off
Initial S/W Revision	Prior to A.02.00

Source Marker 1

Trigger output at marker 1 in current playing Waveform file.

Key Path	Input/Output, Output Config, Trig 1/2 Output
Example	:TRIG1:OUTP S1M
ReadBack	Marker 1
Initial S/W Revision	A.05.01

Source Marker 2

Trigger output at marker 2 in current playing Waveform file.

Key Path	Input/Output, Output Config, Trig 1/2 Output
Example	:TRIG1:OUTP S2M
ReadBack	Marker 2
Initial S/W Revision	A.05.01

Source Marker 3

Trigger output at marker 3 in current playing Waveform file.

Key Path	Input/Output, Output Config, Trig 1/2 Output
Example	:TRIG1:OUTP S3M
ReadBack	Marker 3
Initial S/W Revision	A.05.01

Source Marker 4

Trigger output at marker 4 in current playing Waveform file.

Key Path	Input/Output, Output Config, Trig 1/2 Output
Example	:TRIG1:OUTP S4M
ReadBack	Marker 4
Initial S/W Revision	A.05.01

Analog Out

This menu lets you control which signal is fed to the “Analog Out” connector on the analyzer rear panel.

See ["More Information" on page 157](#)

Key Path	Input/Output, Output Config
Remote Command	:OUTPut:ANALog OFF SVIDeo LOGVIdIo LINVIdIo DAUDIo :OUTPut:ANALog?
Example	OUTP:ANAL SVIDeo ! causes the analog output type to be Screen Video
Preset	This is unaffected by Preset but is set to DAUDIo on a "Restore Input/Output Defaults" or "Restore System Defaults->All
Preset	OFF
State Saved	Saved in Input/Output State
Readback line	1-of-N selection [variable]
Backwards Compatibility Notes	Prior to A.04.00, OFF was the default functionality except when in the Analog Demod application or with Tune and Listen, in which case it was DAUDIo, and there was no selection menu. So for backwards compatibility with earlier X-Series firmware versions, Auto (:OUTP:ANAL:AUTO ON) will duplicate the prior behavior. The DNWB and SANalyzer parameters, which were legal in PSA but perform no function in the X-Series, are accepted without error.
Initial S/W Revision	A.04.00

More Information

The table below gives the range for each output.

Analog Out	Nominal Range exc. (10% overrange)	Scale Factor	Notes
Off	0 V		
Screen Video	0 – 1 V open circuit	10%/division	8566 compatible
Log Video	0 – 1 V terminated	1/(192.66 dB/V)	dB referenced to mixer level, 1 V out for –10 dBm at the mixer.
Linear Video	0 – 1 V terminated	100%/V	Linear referenced to Ref Level, 1 V out for RF envelope at the Ref Level.
Demod Audio	(varies with analyzer setting)		

Auto

Selects the Auto state for the Analog Output menu. In this state, the Analog Output will automatically be set to the most sensible setting for the current mode or measurement.

If you make a selection manually from the Analog Out menu, this selection will remain in force until you change it (or re-select Auto), even if you go to a mode or measurement for which the selected output does not apply.

Key Path	Input/Output, Output Config, Analog Out
Remote Command	OUTPut:ANALog:AUTO OFF ON 0 1 OUTPut:ANALog:AUTO?
Example	OUTP:ANAL:AUTO ON
Preset	ON
State Saved	Saved in Input/Output State
Initial S/W Revision	A.04.00

Off

Turns off the analog output.

Key Path	Input/Output, Output Config, Analog Out
Example	OUTP:ANAL OFF ! causes the analog output to be off
Readback Text	Off
Initial S/W Revision	A.04.00

LISN Control

Enables you to access LISN related functions. LISN control is only available with option LSN indicating that the LISN IO board is installed. This is a remote query command only.

V-network (Remote Command Only)

Enables you to select the V-network that is controlled via the AUX IO port.

Remote Command	INPut [1] 2:LISN[:TYPE] FOURphase ESH2Z5 ENV216 OFF INPut [1] 2:LISN[:TYPE] ?
Example	:INP:LISN FOUR
Notes	FOURPhase and ESH2-Z5 R&S ESH2-Z5 (four phases and protective earth are controllable) ENV216 R&S ENV216 (two phases and highpass are controllable) OFF Remote control deactivated This query will return :- FOUR when ESH2-Z5 is selected.
Preset	Set to off on a "Restore Input/Output Defaults"
State Saved	Saved in instrument state
Initial S/W Revision	A.14.50

Phase (Remote Command Only)

This command enables you to select the phase of the V-network that is used, which is controlled via the AUX IO port. The permissible selection depends on the selected V-network.

Remote Command	INPut [1] 2:LISN:PHASe L1 L2 L3 N INPut [1] 2:LISN:PHASe?
Example	:INP:LISN:PHAS L1
Couplings	L2, L3 keys are grayed out when ENV216 is selected. If the grayed out key is pressed, an advisory message is generated. If the equivalent SCPI command is sent, this same message is generated as part of a "-224, Illegal parameter value; must apply ESH2Z5 to make this phase available" warning.
Preset	Set to N on a "Restore Input/Output Defaults"
State Saved	Saved in instrument state
Range	Phase N Phase L1 Phase L2 Phase L3 Only one phase can be selected.
Initial S/W Revision	A.14.50

150 kHz Highpass (Remote Command Only)

Controls highpass setting on the V-network.

Remote Command	INPut [1] 2:LISN:FILTeR:HPAS[:STATe] ON OFF INPut [1] 2:LISN:FILTeR:HPAS[:STATe] ?
Example	:INP:LISN:FILT:HPAS ON
Dependencies	Only available for ENV216 V-network . This key is grayed out when a V-network that is not ENV216 is selected. If the grayed out key is pressed, an advisory message is generated. If the equivalent SCPI command is sent, this same message is generated as part of a “-221, Settings conflicts; LISN function not available” warning.
Preset	Set to off on a "Restore Input/Output Defaults"
State Saved	Saved in instrument state
Range	ON OFF
Initial S/W Revision	A.14.50

Protective Earth (Remote Command Only)

Enables you to set the Protective Earth setting that is controlled via the AUX IO port.

Remote Command	INPut [1] 2:LISN:PEARth GROunded FLOating INPut [1] 2:LISN:PEARth?
Example	:INP:LISN:PEAR GRO
Dependencies	Only available for ESH2Z5. This key is grayed out when a v-network other than ESH2Z5 is selected. If the grayed out key is pressed, an advisory message is generated. If the equivalent SCPI command is sent, this same message is generated as part of a “-221, Settings conflict; LISN function not available” warning.
Preset	Set to GRO on a "Restore Input/Output Defaults"
State Saved	Saved in instrument state
Range	GRO FLO
Initial S/W Revision	A.14.50

5 Mode Functions

Mode

The Mode key allows you to select the available measurement applications or “Modes”. Modes are a collection of measurement capabilities packaged together to provide an instrument personality that is specific to your measurement needs. Each application software product is ordered separately by Model Number and must be licensed to be available. Once an instrument mode is selected, only the commands that are valid for that mode can be executed.

NOTE

Key operation can be different between modes. The information displayed in Help is about the current mode.

To access Help for a different Mode you must first exit Help (by pressing the Cancel (Esc) key). Then select the desired mode and re-access Help.

For more information on Modes, preloading Modes, and memory requirements for Modes, see ["More Information" on page 163](#)

Key Path	Front-panel key
Remote Command	:INSTrument[:SElect] SA RTSA SEQAN EMI BASIC WCDMA EDGE GSM WIMAXOFDMA VSA PNOISE NFIGure ADEMOD BTooth TDSCDMA CDMA2K CDMA1XEV LTE LTE TDD LTEAFDD LTEATDD MSR DVB DTMB DCTV ISDBT CMMB WLAN CWLAN CWIMAXOFDM WIMAXFIXED IDEN RLC SCPI LC VSA89601 :INSTrument[:SElect]?
Example	:INST SA
Notes	The available parameters are dependent upon installed and licensed applications resident in the instrument. Parameters given here are an example, specific parameters are in the individual Application. A list of the valid mode choices is returned with the INST:CAT? Query.
Preset	This is unaffected by a Preset but is set on a “Restore System Defaults->All” to: SEQAN
State Saved	Saved in instrument state
Backwards Compatibility SCPI	:INSTrument[:SElect] GSM provided for backwards compatibility. Mapped to EDGE GSM.
Backwards Compatibility SCPI	:INSTrument[:SElect] SANalyzer provided for ESU compatibility. When this command is received, the analyzer aliases it to the following: INST:SEL SCPI LC This results in the analyzer being placed in SCPI Language Compatibility Mode, in order to emulate the ESU Spectrum Analyzer Mode.
Backwards Compatibility SCPI	:INSTrument[:SElect] RECeiver provided for ESU compatibility. When this command is received, the analyzer aliases it to the following: :INST:SEL EMI

	:CONF FSC
	This results in the analyzer being placed in the EMI Receiver Mode, running the Frequency Scan measurement, in order to emulate the ESU Receiver Mode.
Initial S/W Revision	Prior to A.02.00
Modified at S/W Revision	A.13.00

Example	:INST 'SA'
Notes	The query is not a quoted string. It is an enumeration as indicated in the Instrument Select table above. The command must be sequential: i.e. continued parsing of commands cannot proceed until the instrument select is complete and the resultant SCPI trees are available.
Backwards Compatibility SCPI	:INSTrument[:SElect] 'SA' 'PNOISE' 'EDGE' 'GSM' 'BASIC'
Initial S/W Revision	Prior to A.02.00

More Information

The Mode name appears on the banner after the word “Keysight” followed by the Measurement Title. For example, for the IQ Analyzer mode with the Complex Spectrum measurement running:

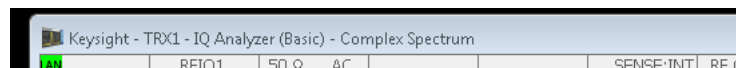

It is possible to specify the order in which the Modes appear in the Mode menu, using the Configure Applications utility (System, Power On, Configure Applications). It is also possible, using the same utility, to specify a subset of the available applications to load into memory at startup time, which can significantly decrease the startup time of the analyzer. During runtime, if an application that is not loaded into memory is selected (by either pressing that applications Mode key or sending that applications :INST:SEL command over SCPI), there will be a pause while the Application is loaded. During this pause a message box that says “Loading application, please wait...” is displayed.

Each application (Mode) that runs in the X-Series signal analyzers consumes virtual memory. The various applications consume varying amounts of virtual memory, and as more applications run, the memory consumption increases. Once an application is run, some of its memory remains allocated even when it is not running, and is not released until the analyzer program (xSA.exe) is shut down.

Keysight characterizes each Mode and assigns a memory usage quantity based on a conservative estimate. There is a limited amount of virtual memory available to applications (note that this is virtual memory and is independent of how much physical RAM is in the instrument). The instrument keeps track of how much memory is being used by all loaded applications – which includes those that preloaded at startup, and all of those that have been run since startup.

When you request a Mode that is not currently loaded, the instrument looks up the memory estimate for that Mode, and adds it to the residual total for all currently loaded Modes. If there is not enough virtual memory to load the Mode, a dialog box and menu will appear that gives you four options:

1. Close and restart the analyzer program without changing your configured preloads. This may free up enough memory to load the requested Mode, depending on your configured preloads
2. Clear out all preloads and close and restart the analyzer program with only the requested application preloaded, and with that application running. This choice is guaranteed to allow you to run the requested application; but you will lose your previously configured preloads. In addition, there may be little or no room for other applications, depending on the size of the requested application.
3. Bring up the Configure Applications utility in order to reconfigure the preloaded apps to make room for the applications you want to run (this will then require restarting the analyzer program with your new configuration). This is the recommended choice because it gives you full flexibility to select exactly what you want.
4. Exit the dialog box without doing anything, which means you will be unable to load the application you requested.

In each case except 4, this will cause the analyzer software to close, and you will lose all unsaved traces and results.

If you attempt to load a mode via SCPI that will exceed memory capacity, the Mode does not load and an error message is returned:

```
-225,"Out of memory;Insufficient resources to load Mode (mode name)"
```

where "mode name" is the SCPI parameter for the Mode in question, for example, SA for Spectrum Analyzer Mode.

IQ Analyzer (Basic)

The IQ Analyzer Mode makes general purpose frequency domain and time domain measurements. These measurements often use alternate hardware signal paths when compared with a similar measurement in the Signal Analysis Mode using the Swept SA measurement. These frequency domain and time domain measurements can be used to output I/Q data results when measuring complex modulated digital signals.

If you are using the Help feature, this mode must be currently active to access its detailed information. If it is not active, exit the Help feature (Esc key), select the mode, and re-access Help.

Key Path	Mode
Example	INST:SEL BASIC INST:NSEL 8
Initial S/W Revision	Prior to A.02.00

W-CDMA with HSPA+

Selects the W-CDMA with HSPA+ mode for general purpose measurements of signals following this standard. There are several measurements available in this mode.

If you are using the Help feature, this mode must be currently active to access its detailed information. If it is not active, exit the Help feature (Esc key), select the mode, and re-access Help.

Key Path	Mode
Example	INST:SEL WCDMA INST:NSEL 9
Initial S/W Revision	Prior to A.02.00

GSM/EDGE/EDGE Evo

Selects the GSM with EDGE mode for general purpose measurements of signals following this standard. There are several measurements available in this mode.

If you are using the Help feature, this mode must be currently active to access its detailed information. If it is not active, exit the Help feature (Esc key), select the mode, and re-access Help.

Key Path	Mode
Example	INST:SEL EDGEGSM INST:NSEL 13
Initial S/W Revision	Prior to A.02.00
Modified at S/W Revision	A.02.00

802.16 OFDMA (WiMAX/WiBro)

Selects the OFDMA mode for general purpose measurements of WiMAX signals. There are several measurements available in this mode.

If you are using the Help feature, this mode must be currently active to access its detailed information. If it is not active, exit the Help feature (Esc key), select the mode, and re-access Help.

Key Path	Mode
Example	INST:SEL WIMAXOFDMA INST:NSEL 75
Initial S/W Revision	Prior to A.02.00

Vector Signal Analyzer (VXA)

The N9064A (formerly 89601X) VXA Vector signal and WLAN modulation analysis application provides solutions for basic vector signal analysis, analog demodulation, and digital demodulation. The digital demodulation portion of N9064A allows you to perform measurements on standard-based formats such as cellular, wireless networking and digital video as well as general purpose flexible modulation analysis for wide range of digital formats, FSK to 1024QAM, with easy-to-use measurements and display tools such as constellation and eye diagram, EVM traces and up to four simultaneous displays. Analog baseband analysis is available using the MXA and PXA with option BBA. Option 3FP WLAN has been discontinued.

N9064A honors existing 89601X licenses with all features and functionalities found on X-Series software versions prior to A.06.00. Specifically:

N9064A-1 is equivalent to 89601X-205

N9064A-2 is equivalent to 89601X-AYA

If you are using the Help feature, this mode must be currently active to access its detailed information. If it is not active, exit the Help feature (Esc key), select the mode, and re-access Help.

Key Path	Mode
Example	INST:SEL VSA INST:NSEL 100
Initial S/W Revision	Prior to A.02.00

Bluetooth

Selects the Bluetooth mode for Bluetooth specific measurements. There are several measurements available in this mode.

If you are using the Help feature, this mode must be currently active to access its detailed information. If it is not active, exit the Help feature (Esc key), select the mode, and re-access Help.

Key Path	Mode
Example	INST:SEL BT INST:NSEL 228
Initial S/W Revision	A.06.01

TD-SCDMA with HSPA/8PSK

Selects the TD-SCDMA mode for general purpose measurements of signals following this standard. There are several measurements available in this mode.

If you are using the Help feature, this mode must be currently active to access its detailed information. If it is not active, exit the Help feature (Esc key), select the mode, and re-access Help.

Key Path	Mode
Example	INST:SEL TDSCDMA INST:NSEL 211
Initial S/W Revision	Prior to A.02.00

cdma2000

Selects the cdma2000 mode for general purpose measurements of signals following this standard. There are several measurements available in this mode.

If you are using the Help feature, this mode must be currently active to access its detailed information. If it is not active, exit the Help feature (Esc key), select the mode, and re-access Help.

Key Path	Mode
Example	INST:SEL CDMA2K INST:NSEL 10
Initial S/W Revision	Prior to A.02.00

1xEV-DO

Selects the 1xEV-DO mode for general purpose measurements of signals following this standard. There are several measurements available in this mode.

If you are using the Help feature, this mode must be currently active to access its detailed information. If it is not active, exit the Help feature (Esc key), select the mode, and re-access Help.

Key Path	Mode
Example	INST:SEL CDMA1XEV INST:NSEL 15
Initial S/W Revision	Prior to A.02.00

WLAN

Selects the WLAN mode for general purpose measurements of signals following this standard. There are several measurements available in this mode.

If you are using the Help feature, this mode must be currently active to access its detailed information. If it is not active, exit the Help feature (Esc key), select the mode, and re-access Help.

Key Path	Mode
Example	INST:SEL WLAN INST:NSEL 217
Initial S/W Revision	A.09.491

LTE-Advanced FDD

If you are using the Help feature, this mode must be currently active to access its detailed information. If it is not active, exit the Help feature (Esc key), select the mode, and re-access Help.

Key Path	Mode
Example	INST:SEL LTEAFDD INST:NSEL 107
Initial S/W Revision	A.14.00

LTE-Advanced TDD

If you are using the Help feature, this mode must be currently active to access its detailed information. If it is not active, exit the Help feature (Esc key), select the mode, and re-access Help.

Key Path	Mode
Example	INST:SEL LTEATDD INST:NSEL 108
Initial S/W Revision	A.14.00

Application Mode Number Selection (Remote Command Only)

Select the measurement mode by its mode number. The actual available choices depend upon which applications are installed in your instrument. The modes appear in this table in the same order they appear in the Mode menu (if the order is not changed by the Configure Applications utility found in the System, Power On menu). See "[Detailed List of Modes](#)" on page 172 for Mode details.

The Mode Number is the parameter for use with the :INSTRument:NSElect command. The Mode Parameter is the parameter for use with the :INSTRument[:SElect] command.

Mode	Mode Number	Mode Parameter
Sequence Analyzer	123	SEQAN
I/Q Analyzer (Basic)	8	BASIC
WCDMA with HSPA+	9	WCDMA
GSM/EDGE/EDGE Evo	13	EDGE GSM
Analog Demod	234	ADEM0D
Bluetooth	228	BT00th
TD-SCDMA with HSPA/8PSK	211	TDSCDMA
cdma2000	10	CDMA2K
1xEV-DO	15	CDMA1XEV
LTE	102	LTE
LTE TDD	105	LTETDD
LTE-Advanced FDD	107	LTEAFDD
LTE-Advanced TDD	108	LTEATDD
WLAN	217	WLAN
802.16 OFDM (Fixed WiMAX)	104	WIMAXFIXED

Remote Command	:INSTRument:NSElect <integer> :INSTRument:NSElect?
Example	:INST:NSEL 1
Notes	SA mode is 1 The command must be sequential: i.e. continued parsing of commands cannot proceed until the instrument select is complete and the resultant SCPI trees are available.
Preset	Not affected by Preset. Set to default mode (1 for SA mode) following Restore System Defaults.
State Saved	Saved in instrument state
Initial S/W Revision	Prior to A.02.00

Application Mode Catalog Query (Remote Command Only)

Returns a string containing a comma separated list of names of all the installed and licensed measurement modes (applications). These names can only be used with the :INSTRument[:SElect] command.

Remote Command	:INSTRument:CATalog?
Example	:INST:CAT?
Notes	Query returns a quoted string of the installed and licensed modes separated with a comma. Example: "SA,PNOISE,WCDMA"
Backwards Compatibility Notes	VSA (E4406A) :INSTRument:CATalog? returned a list of installed INSTRument:SELECT items as a comma separated list of string values: "BASIC","GSM","EDGE GSM","CDMA","NADC","PDC","WCDMA","CDMA2K","CDMA1XEV","IDEN","WIDEN","WLAN","SERVICE" X-Series uses the ESA/PSA compatible query of a string contain comma separated values: "SA,PNOISE,NFIGURE,BASIC,CDMA,CDMA2K,WCDMA,CDMA1XEV,EDGE GSM,GSM,NADC,PDC,TDSCDMA,DMODULATION,WLAN"
Initial S/W Revision	Prior to A.02.00

Application Identification (Remote Commands Only)

Each entry in the Mode Menu will have a Model Number and associated information: Version, and Options.

This information is displayed in the Show System screen. The corresponding SCPI remote commands are defined here.

"Current Application Model " on page 170

"Current Application Revision" on page 170

"Current Application Options" on page 170

Current Application Model

Returns a string that is the Model Number of the currently selected application (mode).

Remote Command	:SYSTem:APPLication[:CURRent][:NAME]?
Example	:SYST:APPL?
Notes	Query returns a quoted string that is the Model Number of the currently selected application (Mode). Example: "N9060A" String length is 6 characters.
Preset	Not affected by Preset
State Saved	Not saved in state, the value will be the selected application when a Save is done.
Initial S/W Revision	Prior to A.02.00

Current Application Revision

Returns a string that is the Revision of the currently selected application (mode).

Remote Command	:SYSTem:APPLication[:CURRent]:REVision?
Example	:SYST:APPL:REV?
Notes	Query returns a quoted string that is the Revision of the currently selected application (Mode). Example: "1.0.0.0" String length is a maximum of 23 characters. (each numeral can be an integer + 3 decimal points)
Preset	Not affected by a Preset
State Saved	Not saved in state, the value will be the selected application when a Save is done.
Initial S/W Revision	Prior to A.02.00

Current Application Options

Returns a string that is the Options list of the currently selected application (Mode).

Remote Command	:SYSTem:APPLication[:CURRent]:OPTion?
Example	:SYST:APPL:OPT?
Notes	Query returns a quoted string that is the Option list of the currently selected application (Mode). The format is the name as the *OPT? or SYSTem:OPTion command: a comma separated list of option identifiers. Example: "1FP,2FP" String length is a maximum of 255 characters.
Preset	Not affected by a Preset

State Saved	Not saved in state per se, the value will be the selected application when a Save is invoked.
Initial S/W Revision	Prior to A.02.00

Application Identification Catalog (Remote Commands Only)

A catalog of the installed and licensed applications (Modes) can be queried for their identification.

"Application Catalog Number of Entries" on page 171

"Application Catalog Model Numbers" on page 171

"Application Catalog Revision" on page 171

"Application Catalog Options" on page 172

Application Catalog Number of Entries

Returns the number of installed and licensed applications (Modes).

Remote Command	:SYSTem:APPLication:CATalog[:NAME]:COUNT?
Example	:SYST:APPL:CAT:COUN?
Preset	Not affected by Preset
State Saved	Not saved in instrument state.
Initial S/W Revision	Prior to A.02.00

Application Catalog Model Numbers

Returns a list of Model Numbers for the installed and licensed applications (Modes).

Remote Command	:SYSTem:APPLication:CATalog[:NAME]?
Example	:SYST:APPL:CAT?
Notes	Returned value is a quoted string of a comma separated list of Model Numbers. Example, if SAMS and Phase Noise are installed and licensed: "N9060A,N9068A" String length is COUNT * 7 - 1. (7 = Model Number length + 1 for comma. -1 = no comma for the 1st entry.)
Preset	Not affected by a Preset
State Saved	Not saved in instrument state.
Initial S/W Revision	Prior to A.02.00

Application Catalog Revision

Returns the Revision of the provided Model Number.

Remote Command	:SYSTem:APPLication:CATalog:REVision? <model>
Example	:SYST:APPL:CAT:REV? 'N9060A'
Notes	Returned value is a quoted string of revision for the provided Model Number. The revision will be a null-string ("") if the provided Model Number is not installed and licensed. Example, if SAMS is installed and licensed: "1.0.0.0"
Preset	Not affected by a Preset.
State Saved	Not saved in instrument state.
Initial S/W Revision	Prior to A.02.00

Application Catalog Options

Returns a list of Options for the provided Model Number

Remote Command	:SYSTem:APPLication:CATalog:OPTion? <model>
Example	:SYST:APPL:CAT:OPT? 'N9060A'
Notes	Returned value is a quoted string of a comma separated list of Options, in the same format as *OPT? or :SYSTem:OPTion?. If the provided Model Number is not installed and licensed a null-string ("") will be returned. Example, if SAMS is installed and licensed: "2FP" String length is a maximum of 255 characters.
Preset	Not affected by a Preset
State Saved	Not saved in instrument state.
Initial S/W Revision	Prior to A.02.00

Detailed List of Modes

This section contains an alphabetical list of Modes available in the X-Series, along with a brief description of each Mode.

Note that with the exception of the 89601 VSA, only licensed applications appear in the Mode menu. The 89601 will always appear, because it's licensing is handled differently.

1xEV-DO

Selects the 1xEV-DO mode for general purpose measurements of signals following this standard. There are several measurements available in this mode.

If you are using the Help feature, this mode must be currently active to access its detailed information. If it is not active, exit the Help feature (Esc key), select the mode, and re-access Help.

Key Path	Mode
----------	------

Example	INST:SEL CDMA1XEV INST:NSEL 15
Initial S/W Revision	Prior to A.02.00

802.16 OFDMA (WiMAX/WiBro)

Selects the OFDMA mode for general purpose measurements of WiMAX signals. There are several measurements available in this mode.

If you are using the Help feature, this mode must be currently active to access its detailed information. If it is not active, exit the Help feature (Esc key), select the mode, and re-access Help.

Key Path	Mode
Example	INST:SEL WIMAXOFDMA INST:NSEL 75
Initial S/W Revision	Prior to A.02.00

89601 VSA

Selecting the 89601 VSA mode will start the 89600 VSA software. The 89600 VSA software is powerful, PC-based software, offering the industry's most sophisticated general purpose and standards specific signal evaluation and troubleshooting tools for R&D engineers. Even for proprietary and non-standard signals in SATCOM or MILCOM applications, you can make signal quality measurements with customized IQ constellation. Reach deeper into signals, gather more data on signal problems, and gain greater insight.

- Over 35 general-purpose analog and digital demodulators ranging from 2FSK to 4096QAM
- Flexible and custom IQ and OFDM signal analysis for single carrier
- Standards specific modulation analysis including:
 - Cellular: GSM/EDGE, cdma2000, W-CDMA, TD-SCDMA, LTE(FDD/TDD),
 - LTE-Advanced and more
 - Wireless networking: 802.11a/b/g, 802.11n, 802.ac, 802.16 WiMAX (fixed/mobile), WiSUN (MR-FSK PHY)
 - RFID
 - Digital satellite video and other satellite signals, radar, LMDS
 - Up to 400K bin FFT, for the highest resolution spectrum analysis
 - A full suite of time domain analysis tools, including signal capture and playback, time gating, and CCDF measurements
 - 20 simultaneous trace displays and the industry's most complete set of marker functions
 - Easy-to-use Microsoft Windows graphical user interface

For more information see the Keysight 89600 Series VSA web site at www.keysight.com/find/89600vsa

To learn more about how to use the 89600 VSA running in the X-Series, after the 89600 VSA software is running, open the 89600 VSA Help and open the "About Keysight X-Series Signal Analyzer with 89600 VSA Software" help topic.

Key Path	Mode
Example	INST:SEL VSA89601 INST:NSEL 101
Initial S/W Revision	Prior to A.02.00

Analog Demod

Selects the Analog Demod mode for making measurements of AM, FM and phase modulated signals.

If you are using the Help feature, this mode must be currently active to access its detailed information. If it is not active, exit the Help feature (Esc key), select the mode, and re-access Help.

Key Path	Mode
Example	INST:SEL ADEMODO INST:NSEL 234
Initial S/W Revision	Prior to A.02.00

Bluetooth

Selects the Bluetooth mode for Bluetooth specific measurements. There are several measurements available in this mode.

If you are using the Help feature, this mode must be currently active to access its detailed information. If it is not active, exit the Help feature (Esc key), select the mode, and re-access Help.

Key Path	Mode
Example	INST:SEL BT INST:NSEL 228
Initial S/W Revision	A.06.01

cdma2000

Selects the cdma2000 mode for general purpose measurements of signals following this standard. There are several measurements available in this mode.

If you are using the Help feature, this mode must be currently active to access its detailed information. If it is not active, exit the Help feature (Esc key), select the mode, and re-access Help.

Key Path	Mode
Example	INST:SEL CDMA2K INST:NSEL 10
Initial S/W Revision	Prior to A.02.00

GSM/EDGE/EDGE Evo

Selects the GSM with EDGE mode for general purpose measurements of signals following this standard. There are several measurements available in this mode.

If you are using the Help feature, this mode must be currently active to access its detailed information. If it is not active, exit the Help feature (Esc key), select the mode, and re-access Help.

Key Path	Mode
Example	INST:SEL EDGE GSM INST:NSEL 13
Initial S/W Revision	Prior to A.02.00
Modified at S/W Revision	A.02.00

IQ Analyzer (Basic)

The IQ Analyzer Mode makes general purpose frequency domain and time domain measurements. These measurements often use alternate hardware signal paths when compared with a similar measurement in the Signal Analysis Mode using the Swept SA measurement. These frequency domain and time domain measurements can be used to output I/Q data results when measuring complex modulated digital signals.

If you are using the Help feature, this mode must be currently active to access its detailed information. If it is not active, exit the Help feature (Esc key), select the mode, and re-access Help.

Key Path	Mode
Example	INST:SEL BASIC INST:NSEL 8
Initial S/W Revision	Prior to A.02.00

LTE

Selects the LTE mode for general purpose measurements of signals following the LTE FDD standard. There are several measurements available in this mode.

If you are using the Help feature, this mode must be currently active to access its detailed information. If it is not active, exit the Help feature (Esc key), select the mode, and re-access Help.

Key Path	Mode
Example	INST:SEL LTE INST:NSEL 102
Initial S/W Revision	Prior to A.02.00

LTE TDD

Selects the LTE TDD mode for general purpose measurements of signals following the LTE TDD standard. There are several measurements available in this mode.

If you are using the Help feature, this mode must be currently active to access its detailed information. If it is not active, exit the Help feature (Esc key), select the mode, and re-access Help.

Key Path	Mode
Example	INST:SEL LTETDD INST:NSEL 105
Initial S/W Revision	A.03.00

LTE-Advanced FDD

If you are using the Help feature, this mode must be currently active to access its detailed information. If it is not active, exit the Help feature (Esc key), select the mode, and re-access Help.

Key Path	Mode
Example	INST:SEL LTEAFDD INST:NSEL 107
Initial S/W Revision	A.14.00

LTE-Advanced TDD

If you are using the Help feature, this mode must be currently active to access its detailed information. If it is not active, exit the Help feature (Esc key), select the mode, and re-access Help.

Key Path	Mode
Example	INST:SEL LTEATDD INST:NSEL 108
Initial S/W Revision	A.14.00

Sequence Analyzer

Selects the Sequence Analyzer mode for sequenced measurements. Depending on licensed applications there may be a number of different measurements available in this mode. These measurements are all done on IQ captured data and can be set up to calculated on any part of the capture.

If you are using the Help feature, this mode must be currently active to access its detailed information. If it is not active, exit the Help feature (Esc key), select the mode, and re-access Help.

Key Path	Mode
Example	INST:SEL SEQAN INST:NSEL 400
Initial S/W Revision	A.05.01

TD-SCDMA with HSPA/8PSK

Selects the TD-SCDMA mode for general purpose measurements of signals following this standard. There are several measurements available in this mode.

If you are using the Help feature, this mode must be currently active to access its detailed information. If it is not active, exit the Help feature (Esc key), select the mode, and re-access Help.

Key Path	Mode
Example	INST:SEL TDSCDMA INST:NSEL 211
Initial S/W Revision	Prior to A.02.00

Vector Signal Analyzer (VXA)

The N9064A (formerly 89601X) VXA Vector signal and WLAN modulation analysis application provides solutions for basic vector signal analysis, analog demodulation, and digital demodulation. The digital demodulation portion of N9064A allows you to perform measurements on standard-based formats such as cellular, wireless networking and digital video as well as general purpose flexible modulation analysis for wide range of digital formats, FSK to 1024QAM, with easy-to-use measurements and display tools such as constellation and eye diagram, EVM traces and up to four simultaneous displays. Analog baseband analysis is available using the MXA and PXA with option BBA. Option 3FP WLAN has been discontinued.

N9064A honors existing 89601X licenses with all features and functionalities found on X-Series software versions prior to A.06.00. Specifically:

N9064A-1 is equivalent to 89601X-205

N9064A-2 is equivalent to 89601X-AYA

If you are using the Help feature, this mode must be currently active to access its detailed information. If it is not active, exit the Help feature (Esc key), select the mode, and re-access Help.

Key Path	Mode
Example	INST:SEL VSA INST:NSEL 100
Initial S/W Revision	Prior to A.02.00

W-CDMA with HSPA+

Selects the W-CDMA with HSPA+ mode for general purpose measurements of signals following this standard. There are several measurements available in this mode.

If you are using the Help feature, this mode must be currently active to access its detailed information. If it is not active, exit the Help feature (Esc key), select the mode, and re-access Help.

Key Path	Mode
Example	INST:SEL WCDMA INST:NSEL 9
Initial S/W Revision	Prior to A.02.00

WLAN

Selects the WLAN mode for general purpose measurements of signals following this standard. There are several measurements available in this mode.

If you are using the Help feature, this mode must be currently active to access its detailed information. If it is not active, exit the Help feature (Esc key), select the mode, and re-access Help.

Key Path	Mode
Example	INST:SEL WLAN INST:NSEL 217
Initial S/W Revision	A.09.491

Global Settings

Opens a menu that allows you to switch certain Meas Global parameters to a Mode Global state. These switches apply to all Modes that support global settings. No matter what Mode you are in when you set the “Global Center Frequency” switch to on, it applies to all Modes that support Global Settings.

Key Path	Mode Setup
Initial S/W Revision	Prior to A.02.00

Global Center Freq

The software maintains a Mode Global value called “Global Center Freq”.

When the Global Center Freq key is switched to On in any mode, the current mode’s center frequency is copied into the Global Center Frequency, and from then on all modes that support global settings use the Global Center Frequency. So you can switch between any of these modes and the Center Freq will remain unchanged.

Adjusting the Center Freq of any mode which supports Global Settings, while Global Center Freq is On, will modify the Global Center Frequency.

When Global Center Freq is turned Off, the Center Freq of the current mode is unchanged, but now the Center Freq of each mode is once again independent.

When Mode Preset is pressed while Global Center Freq is On, the Global Center Freq is preset to the preset Center Freq of the current mode.

This function is reset to Off when the Restore Defaults key is pressed in the Global Settings menu, or when System, Restore Defaults, All Modes is pressed.

Key Path	Mode Setup, Global Settings
Scope	Mode Global
Remote Command	:INSTrument:COUPle:FREQuency:CENTer ALL NONE :INSTrument:COUPle:FREQuency:CENTer?
Example	INST:COUP:FREQ:CENT ALL INST:COUP:FREQ:CENT?
Preset	Set to Off on Global Settings, Restore Defaults and System, Restore Defaults, All Modes
Range	On Off
Initial S/W Revision	Prior to A.02.00

Remote Command	:GLOBal:FREQuency:CENTer[:STATe] 1 0 ON OFF :GLOBal:FREQuency:CENTer[:STATe]?
Preset	Off
Initial S/W Revision	Prior to A.02.00

Restore Defaults

This key resets all of the functions in the Global Settings menu to Off. This also occurs when System, Restore Defaults, All Modes is pressed.

Key Path	Mode Setup, Global Settings
Remote Command	:INSTrument:COUPle:DEFault

Example	INST:COUP:DEF
Backwards Compatibility SCPI	:GLOBal:DEFault
Initial S/W Revision	Prior to A.02.00

Mode Setup

This key accesses a menu to allow you to select mode parameters. These settings will be in effect for all measurements in the current mode.

Key Path	Front-panel key
----------	-----------------

Radio

Accesses a key that enables you to select either a base transceiver station (BTS) or a mobile station (MS) as the device under test.

Key Path	Mode Setup
----------	------------

Device

Allows you to specify the device to be used.

Key Path	Mode Setup, Radio
Mode	CDMA2K
Remote Command	<code>[:SENSe] :RADio:STANdard:DEVIce BTS MS</code> <code>[:SENSe] :RADio:STANdard:DEVIce?</code>
Example	<code>RADio:DEVIce BTS</code> <code>RADio:DEVIce?</code>
Preset	BTS
State Saved	Saved in instrument state
Range	BTS MS

Restore Mode Defaults

Resets the state for the currently active mode by resetting the mode persistent settings to their factory default values, clearing mode data and by performing a Mode Preset. This function will never cause a mode switch. This function performs a full preset for the currently active mode; whereas, Mode Preset performs a partial preset. Restore Mode Defaults does not affect any system settings. System settings are reset by the Restore System Defaults function. This function does reset mode data; as well as settings.

Key Path	Mode Setup
Remote Command	<code>:INSTrument:DEFault</code>
Example	<code>:INST:DEF</code>
Notes	Clears all pending OPC bits. The Status Byte is set to 0. A message comes up saying: "If you are sure, press key again".

Couplings	A Restore Mode Defaults will cause the currently running measurement to be aborted and causes the default measurement to be active. It gets the mode to a consistent state with all of the default couplings set.
Initial S/W Revision	Prior to A.02.00

Preset Type (Remote Command Only)

As stated in the Backward Compatibility section, to be compatible with ESA/PSA the PRESet:TYPE command will be implemented as a no-op.

Mode	All
Remote Command	:SYSTem:PRESet:TYPE FACTory MODE USER :SYSTem:PRESet:TYPE?
Example	:SYST:PRE:TYPE FACT
Notes	This command is supported for backward compatibility only. It is a no-op which does not change the behavior of any preset operation.
Preset	This is unaffected by Preset but is set to Mode on a "Restore System Defaults->All"
State Saved	No
Initial S/W Revision	Prior to A.02.00

6 System Functions

File

Opens a menu that enables you to access various standard and custom Windows functions. Press any other front-panel key to exit

Key Path	Front-panel key
Initial S/W Revision	Prior to A.02.00

File Explorer

Opens the standard Windows File Explorer. The File Explorer opens in the My Documents directory for the current user.

The File Explorer is a separate Windows application, so to return to the analyzer once you are in the File Explorer, you may either:

Exit the File Explorer by clicking on the red X in the upper right corner, with a mouse

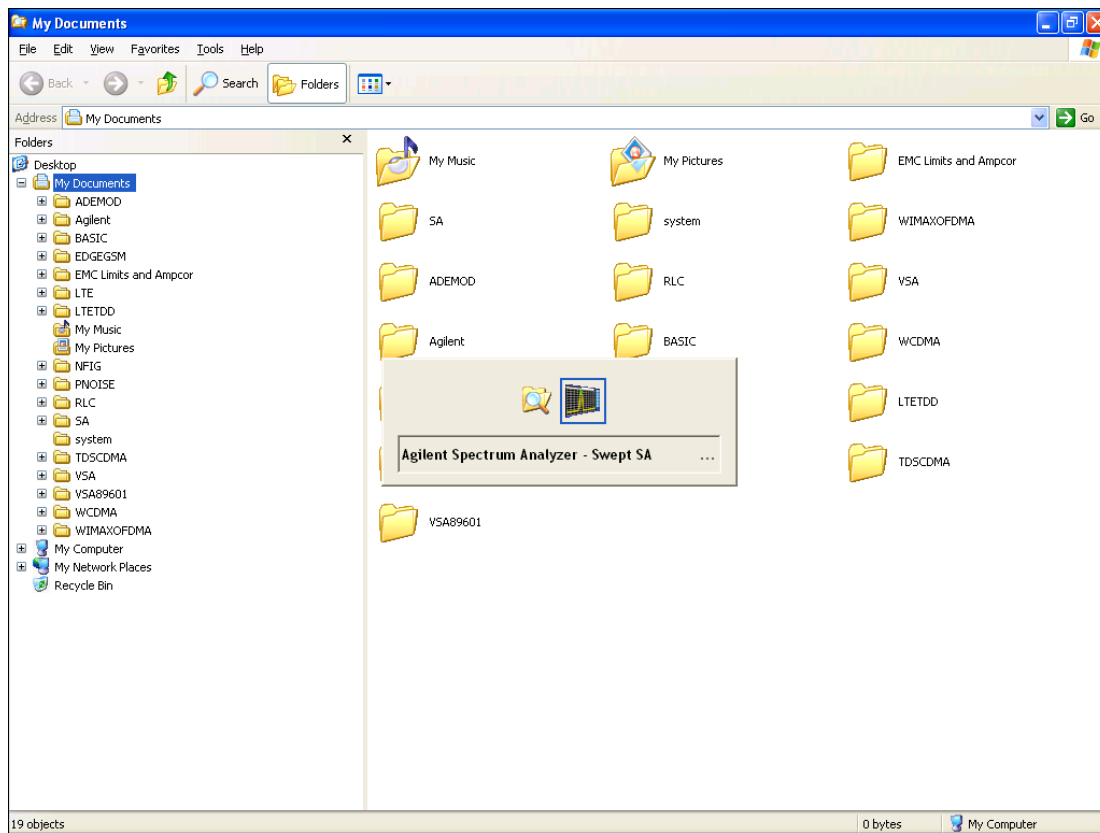

Or use Alt-Tab: press and hold the Alt key and press and release the Tab key until the Analyzer logo is showing in the window in the center of the screen, as shown above, then release the Alt key.

The ability to access File Explorer is not available if Option SF1 is installed.

Key Path	File
Initial S/W Revision	Prior to A.02.00

Page Setup

The Page Setup key brings up a Windows Page Setup dialog that allows you to control aspects of the pages sent to the printer when the PRINT hardkey is pressed.

Key Path	File
Initial S/W Revision	Prior to A.02.00

Paper size, the printer paper source, the page orientation and the margins are all settable. Just like any standard Windows dialog, you may navigate the dialog using the front-panel keys, or a mouse. There are no SCPI commands for controlling these parameters.

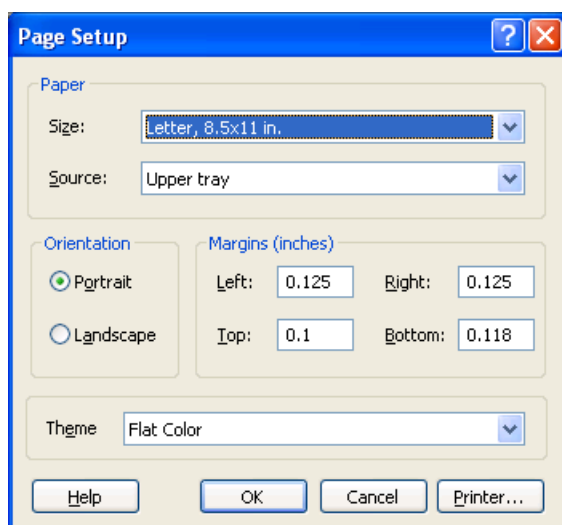

Also contained in this dialog is a drop-down control that lets you select the Theme to use when printing. For more on Themes, see information under View/Display, Display, System Display Settings, Theme. The Theme control has a corresponding SCPI command.

Parameter Name	Print Themes
Parameter Type	Enum
Mode	All
Remote Command	:SYSTem:PRINt:THEME TDCoLor TDMonochrome FCOLor FMONochrome :SYSTem:PRINt:THEME?
Example	:SYST:PRIN:THEM FCOL
Setup	:SYSTem:DEFault MISC
Preset	FCOL; not part of Preset, but is reset by Restore Misc Defaults or Restore System Defaults All and

	survives subsequent running of the modes.
State Saved	No
Initial S/W Revision	Prior to A.02.00

Print

This front-panel key is equivalent to performing a File, Print, OK. It immediately performs the currently configured Print to the Default printer.

The :HCOPY command is equivalent to pressing the PRINT key. The HCOpy:ABORt command can be used to abort a print which is already in progress. Sending HCOpy:ABORt will cause the analyzer to stop sending data to the printer, although the printer may continue or even complete the print, depending on how much data was sent to the printer before the user sent the ABORt command.

Key Path	Front-panel key
Remote Command	:HCOPY[:IMMediate]
Initial S/W Revision	Prior to A.02.00

Key Path	SCPI command only
Remote Command	:HCOPY:ABORt
Initial S/W Revision	Prior to A.02.00

Maximize

This key allows you to Maximize the Instrument Application, which causes the analyzer display to fill the screen. Once the application is maximized, this key is replaced by the Restore Down key.

Key Path	File
Mode	All
Notes	No equivalent remote command for this key.
State Saved	No
Initial S/W Revision	A.05.01

Minimize

The Minimize key causes the analyzer display to disappear down into the task bar, allowing you to see the Windows Desktop. You can use Alt-Tab (press and hold the Alt  key and press and release the Tab key) to restore the analyzer display.

Key Path	File
Mode	All
Notes	No equivalent remote command for this key.
State Saved	No
Initial S/W Revision	A.05.01

Exit

This key, when pressed, will exit the Instrument Application. A dialog box is used to confirm that you intended to exit the application:

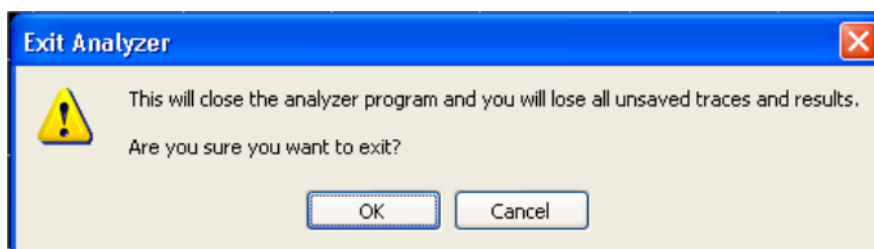

Key Path	File
Mode	All
Notes	The Instrument Application will close. No further SCPI commands can be sent. Use with caution!
Initial S/W Revision	Prior to A.02.00

Print

This front-panel key is equivalent to performing a File, Print, OK. It immediately performs the currently configured Print to the Default printer.

The :HCOPY command is equivalent to pressing the PRINT key. The HCOPY:ABORT command can be used to abort a print which is already in progress. Sending HCOPY:ABORT will cause the analyzer to stop sending data to the printer, although the printer may continue or even complete the print, depending on how much data was sent to the printer before the user sent the ABORT command.

Key Path	Front-panel key
Remote Command	:HCOPY[:IMMEDIATE]
Initial S/W Revision	Prior to A.02.00

Key Path	SCPI command only
Remote Command	:HCOPY:ABORT
Initial S/W Revision	Prior to A.02.00

System

Opens a menu of keys that access various configuration menus and dialogs.

Key Path	Front-panel key
Notes	No remote command for this key specifically.
Initial S/W Revision	Prior to A.02.00

Show

Accesses a menu of choices that enable you to select the information window you want to view.

Key Path	System
Mode	All
Remote Command	:SYSTem:SHOW OFF ERRor SYSTem HARDware LXI HWSTatistics ALIGNment SOFTware CAPplication :SYSTem:SHOW?
Example	:SYST:SHOW SYST
Notes	This command displays (or exits) the various System information screens.
Preset	OFF
State Saved	No
Range	OFF ERRor SYSTem HARDware LXI HWSTatistics ALIGNment SOFTware CAPplication
Initial S/W Revision	Prior to A.02.00

Errors

There are two modes for the Errors selection, History and Status.

The list of errors displayed in the Errors screen does not automatically refresh. You must press the Refresh key or leave the screen and return to it to refresh it.

History brings up a screen displaying the event log in chronological order, with the newest event at the top. The history queue can hold up to 100 messages (if a message has a repeat count greater than 1 it only counts once against this number of 100). Note that this count bears no relation to the size of the SCPI queue. If the queue extends onto a second page, a scroll bar appears to allow scrolling with a mouse. Time is displayed to the second.

Status brings up a screen summarizing the status conditions currently in effect. Note that the time is displayed to the second.

The fields on the Errors display are:

Type (unlabeled) - Displays the icon identifying the event or condition as an error or warning.

ID - Displays the error number.

Message - Displays the message text.

Repeat (RPT) - This field shows the number of consecutive instances of the event, uninterrupted by other events. If an event occurs 5 times with no other intervening event, the value of repeat will be 5.

If the value of Repeat is 1 the field does not display. If the value of Repeat is >1, the time and date shown are those of the most recent occurrence. If the value of repeat reaches 999,999 it stops there.

Time - Shows the most recent time (including the date) at which the event occurred.

Key Path	System, Show
Mode	All
Remote Command	:SYSTem:ERRor[:NEXT]?
Example	:SYST:ERR?
Notes	The return string has the format: “<Error Number>,<Error>” Where <Error Number> and <Error> are those shown on the Show Errors screen
Backwards Compatibility Notes	In some legacy analyzers, the Repeat field shows the number of times the message has repeated since the last time the error queue was cleared. In the X-Series, the Repeat field shows the number of times the error has repeated since the last intervening error. So the count may very well be different than in the past even for identical signal conditions Unlike previous analyzers, in the X-Series all errors are reported through the Message or Status lines and are logged to the event queue. They never appear as text in the graticule area (as they sometimes do in previous analyzers) and they are never displayed in the settings panel at the top of the screen (as they sometimes do, by changing color, in previous analyzers). As a consequence of the above, the user can only see one status condition (the most recently generated) without looking at the queue. In the past, at least in the Spectrum Analyzer, multiple status conditions might display on the right side of the graticule. In general, there is no backwards compatibility specified or guaranteed between the error numbers in the X-Series and those of earlier products. Error, event, and status processing code in customers' software will probably need to be rewritten to work with X-Series. In the legacy analyzers, some conditions report as errors and others simply turn on status bits. Conditions that report as errors often report over and over as long as the condition exists. In the X-series, all conditions report as start and stop events. Consequently, software that repeatedly queries for a condition error until it stops reporting will have to be rewritten for the X-series.
Initial S/W Revision	Prior to A.02.00

Previous Page

See ["Next Page" on page 191](#).

Key Path	System, Show, Errors
Initial S/W Revision	Prior to A.02.00

Next Page

Next Page and Previous Page menu keys move you between pages of the log, if it fills more than one page. These keys are grayed out in some cases:

- If on the last page of the log, the Next Page key is grayed-out
- If on the first page of the log, the Previous Page key is grayed-out.
- If there is only one page, both keys are grayed out.

Key Path	System, Show, Errors
Initial S/W Revision	Prior to A.02.00

History

The History and Status keys select the Errors view. The Status key has a second line that shows a number in [square brackets]. This is the number of currently open status items.

Key Path	System, Show, Errors
Initial S/W Revision	Prior to A.02.00

Verbose SCPI On/Off

When you turn Verbose SCPI on, additional information is returned when you send the :SYSTem:ERRor? query. The additional information consists of the characters that stimulated the error. This can aid you in debugging your test programs by indicating where in the parsing of a SCPI command the instrument encountered an invalid command or query.

Specifically, with Verbose SCPI on, the SYSTem:ERRor? query is expanded to show the SCPI data received, with the indicator <Err> at the point in the stream that the error occurred.

Verbose SCPI has no effect on the Show Errors screen or front panel Message Line; it only changes the response to the :SYST:ERR? query.

See the example below, where the invalid command "SENS:BOGUS" is sent:

Normal response to :SYST:ERR (using the Telnet window):

```
SCPI> SENS:BOGUS
```

```
SCPI> SYST:ERR?
```

```
-113,"Undefined header"
```

Now after turning on Verbose SCPI:

```
SCPI> SYST:BOGUS
```

```
SCPI> SYST:ERR?
```

```
-113,"Undefined header;SYST:BOGUS<Err>"
```

Key Path	System, Show, Errors
Mode	All
Remote Command	:SYSTem:ERRor:VERBoSe OFF ON 0 1 :SYSTem:ERRor:VERBoSe?
Example	:SYST:ERR:VERB ON
Preset	This is unaffected by Preset but is set to OFF on a "Restore System Defaults->Misc"
State Saved	No
Range	On Off
Initial S/W Revision	Prior to A.02.00

Refresh

When pressed, refreshes the Show Errors display.

Key Path	System, Show, Errors
Initial S/W Revision	Prior to A.02.00

Clear Error Queue

This clears all errors in all error queues.

Note the following:

- Clear Error Queue does not affect the current status conditions.
- Mode Preset does not clear the error queue.
- Restore System Defaults will clear all error queues.
- *CLS only clears the queue if it is sent remotely and *RST does not affect any error queue.
- Switching modes does not affect any error queues.

Key Path	System, Show, Errors
Initial S/W Revision	Prior to A.02.00

Status

See "[History](#)" on page 191.

Input Overload Enable (Remote Command Only)

Input Overload errors are reported using the Input Overload status bit (bit 12 in the Measurement Integrity status register). Input Overloads (for example, ADC Overload errors) can come and go with great frequency, generating many error events (for example, for signals just on the verge of overload), and so are

not put into the SCPI error queue by default. Normally the status bit is the only way for detecting these errors remotely.

It is possible to enable Input Overload reporting to the SCPI queue, by issuing the :SYSTem:ERRor:OVERload ON command. To return to the default state, issue the :SYSTem:ERRor:OVERload OFF command. In either case, Input Overloads always set the status bit.

NOTE

For versions of firmware before A.10.01, the Input Overload was only a Warning and so was never available in the SCPI queue, although it did set the status bit. For A.10.01 and later, the Input Overload is an error and can be enabled to the SCPI queue using this command.

Key Path	SCPI only
Remote Command	:SYSTem:ERRor:OVERload[:STATe] 0 1 OFF ON
Example	:SYST:ERR:OVER 1 Enable overload errors
Preset	Set to OFF by Restore Misc Defaults (no Overload errors go to SCPI)
State Saved	Saved in instrument state.
Initial S/W Revision	A.10.01

Power Up (Remote Command Only)

This serves to show the errors encountered during the application boot-up, such as: mismatch FW-FPGA, missing Calibration data, missing hardware and construction errors.

Remote Command	:SYSTem:ERRor:PUP?
Notes	<p>If no error occurs, the return value will be: "No Power Up Errors." Return Value: <list of error strings>. <List of error strings> is an <IEEE488 Block> format. Return Value Example: "Power up errors, see details in Windows Event Log" "Unmatched FPGA Version(s), See details in Windows Event Log"</p>
Initial S/W Revision	E.14.30

System

The System screen is formatted into three groupings: product descriptive information, options tied to the hardware, and software products:

```

<Product Name> <Product Description>
Product Number: N9020A
Serial Number: US46220924
Firmware Revision: A.01.01
Computer Name: <hostname>
Host ID: N9020A,US44220924

N9020A-503      Frequency Range to 3.6 GHz
N9020A-PFR     Precison Frequency Reference
N9020A-P03     Preamp 3.6 GHz

N9060A-2FP     Spectrum Analysis Measurement Suite  1.0.0.0
N9073A-1FP     WCDMA                               1.0.0.0
N9073A-2FP     WCDMA with HSDPA                     1.0.0.0
    
```

The Previous Page is grayed-out if the first page of information is presently displayed. The Next Page menu key is grayed-out if the last page is information is presently displayed.

Key Path	System, Show
Mode	All
Example	SYST:SHOW SYST
Backwards Compatibility Notes	The hardware statistics that are displayed in the PSA Show System screen have been moved to a dedicated Show Hardware Statistics screen in the Service Menu.
Initial S/W Revision	Prior to A.02.00

Show System contents (Remote Command Only)

A remote command is available to obtain the contents of the Show System screen (the entire contents, not just the currently displayed page).

Remote Command	:SYSTem:CONFigure [:SYSTem] ?
Example	:SYST:CONF?
Notes	The output is an IEEE Block format of the Show System contents. Each line is separated with a new-line character.
Initial S/W Revision	Prior to A.02.00

Computer System description (Remote Command Only)

A remote command is available to obtain the Computer System description. The Computer System is the operating system and patch level as reported by operating system.

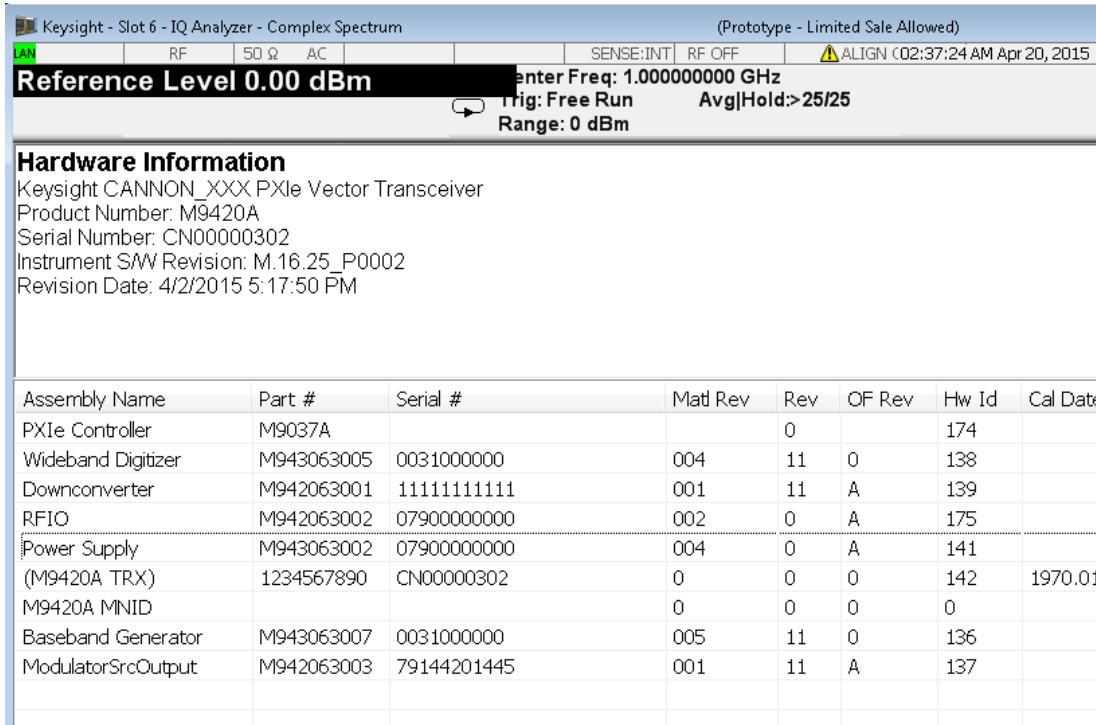

The Previous Page is grayed-out if the first page of information is presently displayed. The Next Page menu key is grayed-out if the last page is information is presently displayed.

Key Path	System, Show
Mode	All
Example	SYST:SHOW HARD
Initial S/W Revision	Prior to A.02.00

System Remote Commands (Remote Commands Only)

The commands in this section have no front-panel key equivalent.

- "System Powerdown (Remote Command Only)" on page 197
- "System Log Off (Remote Command Only)" on page 197
- "List installed Options (Remote Command Only)" on page 197
- "Lock the Front-panel keys (Remote Command Only)" on page 197
- "Front Panel activity history (Remote Command only)" on page 198
- "SCPI Version Query (Remote Command Only)" on page 200
- "Date (Remote Command Only)" on page 200
- "Time (Remote Command Only)" on page 200

Initial S/W Revision	Prior to A.02.00
----------------------	------------------

System Powerdown (Remote Command Only)

Remote Command	SYSTem:PDOWn [NORMal FORCe]
Notes	Shuts down the instrument in the normal way (NORMal) or forced way (FORCe). In case there is another application with modified data pending for saving, the application prompt the user. The system waits until the user responds in the normal mode. It will go off after 20 seconds of wait in the force mode and all data will be lost.

System Log Off (Remote Command Only)

This SCPI command provides a means to terminate all open Windows applications and log off the current user. This is equivalent to performing the Windows command “shutdown -l -f -t0”.

Remote Command	SYSTem:LOFF
Example	SYST:LOFF
Notes	Initiates an immediate log off of the current user. This exits the instrument application, thus any unsaved measurement result will be lost. You cannot use *WAI or *OPC? to synchronize operation. In addition to the instrument application, all other Windows programs will be terminated without the opportunity to save any work in progress. The instrument will require human interaction to perform a Log In to regain instrument operation.
Initial S/W Revision	A.14.50

List installed Options (Remote Command Only)

Lists the installed options that pertain to the instrument (signal analyzer).

Mode	All
Remote Command	:SYSTem:OPTions?
Example	:SYST:OPT?
Notes	The return string is a comma separated list of the installed options. For example: “503,P03,PFR” :SYSTem:OPTions? and *OPT? are the same.
State Saved	No
Initial S/W Revision	Prior to A.02.00

Lock the Front-panel keys (Remote Command Only)

Disables the instrument keyboard to prevent local input when the instrument is controlled remotely. Annunciation showing a “K” for ‘Klock’ (keyboard lock) alerts the local user that the keyboard is locked. Klock is similar to the GPIB Local Lockout function; namely that no front-panel keys are active with the

exception of the Power Standby key. (The instrument is allowed to be turned-off if Klock is ON.) The Klock command is used in remote control situations where Local Lockout cannot be used.

Although primary intent of Klock is to lock-out the front panel, it will lock-out externally connected keyboards through USB. Klock has no effect on externally connected pointing devices (mice).

The front panel 'Local' key (Cancel/Esc) has no effect if Klock is ON.

Mode	All
Remote Command	:SYSTem:KLOCK OFF ON 0 1 :SYSTem:KLOCK?
Example	:SYST:KLOC ON
Notes	Keyboard lock remains in effect until turned-off or the instrument is power-cycled
Preset	Initialized to OFF at startup, unaffected by Preset
State Saved	No
Initial S/W Revision	Prior to A.02.00

Front Panel activity history (Remote Command only)

Instrument front panel usage can be monitored with the query :SYSTem:METRics:FPANel?. The monitoring occurs for front panel Hardkey or Softkey operation (not mouse or touch operation on instruments with Multi-Touch User Interface). The information of the usage pertains to the activity since the instrument application was started; the information does not persist after the application is terminated, or the instrument has been rebooted.

To prevent the front panel from being placed into Remote the monitoring must occur via an I/O protocol such as LAN Socket, or the remote program performing the monitoring must explicitly place the instrument into Local after the query has been performed.

Remote Command	:SYSTem:METRics:FPANel?
Example	SYST:METR:FPAN?
Notes	The return value is a string with the format "YYYY-MM-DD<space>HH:MM:SS", in instrument local time. If no front panel activity has occurred since the instrument was booted (instrument application started), the return value will be the time the instrument application started. The instrument application start time can be obtained with the query SYSTem:METRics:STIME?
Initial S/W Revision	x.16.10

SCPI activity history (Remote Command only)

Instrument remote operation usage via SCPI can be monitored with the query :SYSTem:METRics:SCPI?. The monitoring occurs for SCPI control from any I/O channel (GPIB, USB, or LAN). The information of the usage pertains to the activity since the instrument application was started; the information does not persist after the application is terminated, or the instrument has been rebooted.

Remote Command	:SYSTem:METRics:SCPI?
Example	:SYST:METR:SCPI?
Notes	<p>The return value is a string with the format “YYYY-MM-DD <space> HH:MM:SS”, in instrument local time.</p> <p>The following commands are excluded from the history accounting:</p> <ul style="list-style-type: none"> *IDN? *OPT? :SYSTem:DATE? :SYSTem:TIME? :SYSTem:PON:TIME? <p>Queries in the :SYSTem:ERRor subsystem Queries in the :SYSTem:LKEY subsystem Queries in the :SYSTem:METRics subsystem Queries in the :SYSTem:MODule subsystem</p> <p>If no SCPI activity has occurred since the instrument was booted (instrument application started), the return value will be the time the instrument application started. The instrument application start time can be obtained with the query SYSTem:METRics:STIME?</p>
Initial S/W Revision	x.16.10

Instrument start time (Remote Command only)

To determine if instrument activity has occurred the SCPI query :SYSTem:METRics:STIME? can be used to determine the instrument application start time.

Remote Command	:SYSTem:METRics:STIME?
Example	:SYST:METR:STIM?
Notes	The return value is a string with the format “YYYY-MM-DD <space> HH:MM:SS”, in instrument local time.
Initial S/W Revision	x.16.10

List SCPI Commands (Remote Command Only)

Outputs a list of the valid SCPI commands for the currently selected Mode.

Remote Command	:SYSTem:HELP:HEADers?
Example	:SYST:HELP:HEAD?
Notes	The output is an IEEE Block format with each command separated with the New-Line character (hex 0x0A)
Initial S/W Revision	Prior to A.02.00

SCPI Version Query (Remote Command Only)

Returns the SCPI version number with which the instrument complies. The SCPI industry standard changes regularly. This command indicates the version used when the instrument SCPI commands were defined.

Remote Command	:SYSTem:VERSion?
Example	:SYST:VERS?
Initial S/W Revision	Prior to A.02.00

Date (Remote Command Only)

The recommended access to the Date, Time, and Time zone of the instrument is through the Windows native control (Control Panel or accessing the Task Bar). You may also access this information remotely, as shown in this command and Time (below).

Sets or queries the date in the instrument.

Mode	All
Remote Command	:SYSTem:DATE "<year>,<month>,<day>" :SYSTem:DATE?
Example	:SYST:DATE "2006,05,26"
Notes	<year> is the four digit representation of year. (for example, 2006) <month> is the two digit representation of year. (for example. 01 to 12) <day> is the two digit representation of day. (for example, 01 to 28, 29, 30, or 31) depending on the month and year Unless the current account has Power User or Administrator privileges, an error will be generated by this command and no action will be taken.
Initial S/W Revision	Prior to A.02.00

Time (Remote Command Only)

Sets or queries the time in the instrument.

Mode	All
Remote Command	:SYSTem:TIME "<hour>,<minute>,<second>" :SYSTem:TIME?
Example	:SYST:TIME "13,05,26"
Notes	<hour> is the two digit representation of the hour in 24 hour format <minute> is the two digit representation of minute <second> is the two digit representation of second Unless the current account has Power User or Administrator privileges, an error will be generated by this command and no action will be taken.
Initial S/W Revision	Prior to A.02.00

Module Name (Remote Command Only)

Query only. This will return the name of the instance as displayed on the xSA main window.

Mode	All
Remote Command	:SYSTem:MODule:NAME?
Example	:SYST:MOD:NAME?
Notes	The Display Name of the module will be returned. The Display name shows the location of the module with which the application is running. Display name uses format of "Chassis <number> - Slot <number>". If there is only one chassis is used, "Chassis <number> - "will be ignored, the display name will become "Slot <number>".
Preset	Not affected by Preset, reset to "Left" with Restore System Defaults Misc.
State Saved	No
Initial S/W Revision	A.13.80

Module Index (Remote Command Only)

Query only. This will return the index of this xSA instance. This index is used as the device number in a VISA address ("hlistip#").

Mode	All
Remote Command	:SYSTem:MODule:INDEx?
Example	:SYST:MOD:IND?
Notes	The returned value is meaningless on M9420A.3.
Preset	Not affected by Preset, reset to 0 with Restore System Defaults Misc.
State Saved	No
Initial S/W Revision	A.13.80

Module Mnemonic (Remote Command Only)

Query only. This will return the mnemonic of the instance as used in the command line "/Process:<mnemonic>" argument.

Mode	All
Remote Command	:SYSTem:MODule:MNEMonic?
Example	:SYST:MOD:MNEM?
Notes	This will return the mnemonic of the instance as used in the command line "/Process:<mnemonic>" argument.

Preset	Not affected by Preset and Restore System Defaults Misc.
State Saved	No
Initial S/W Revision	A.13.80

Module List (Remote Command Only)

Query only. This will return the list of defined mnemonics that can be used in the command line “/Process:<mnemonic>” argument with corresponding configuration information. The comma separated return values are: mnemonic, display name, Enabled/Disabled, VISA device id (instr# or hislip#), telnet port, socket port, Physics port, Physics configuration tag.

Mode	All
Remote Command	:SYSTem:MODule:LIST?
Example	:SYST:MOD:LIST?
Notes	Example: it returns: M9290A_US00000001,Slot 1,Enabled,0,5023,5025,3574 M9290A_US00000002,Slot 5,Enabled,1,5123,5125,3575 M9290A_US00000003,Slot 11,Enabled,2,5223,5225,3576 M9290A_US00000004,Slot 15,Enabled,3,5323,5325,3577
Preset	Not affected by Preset, reset to 0 with Restore System Defaults Misc.
State Saved	No
Initial S/W Revision	A.13.80

Module Enable (Remote Command Only)

Query and command. The query SYST:MOD:ENAB? “<mnemonic>” returns “0” for disabled, “1” for enabled. The command SYST:MOD:ENAB “<mnemonic>” 0|1 will disable/enable the configuration.

Notes: Enabling a configuration that does not have a HW will result in run-time errors when trying to start that configuration. Trying to disable the default configuration will result in the error: -221, “Setting conflict:Cannot disable default process configuration ‘<mnemonic>”.

Example:

```
}
SCPI>>sys:mod:enab? "M9290A_US00000001"
<<1
SCPI>>sys:mod:enab? "M9290A_US00000002"
<<0
```

SCPI>>syst:err?

<<+0,"No error"

SCPI>>syst:mod:enab "M9290A_US00000001",0

SCPI>>syst:err?

<<-221,"Settings conflict;Cannot disable default process configuration 'M9290A_US00000001'"

Mode	All
Remote Command	:SYSTem:MODule:ENABle? "<mnemonic>" :SYSTem:MODule:ENABle "<mnemonic>",<0 1
Example	:SYST:MOD:ENAB? "M9290A_US00000001" :SYST:MOD:ENAB "M9290A_US00000001",0
Preset	Not affected by Preset and Restore System Defaults Misc.
State Saved	No
Initial S/W Revision	A.13.80

Module Default (Remote Command Only)

Query and command. The query SYST:MOD:DEF? returns the mnemonic of the default configuration. The command SYST:MOD:DEF "mnemonic" will set that configuration as the default. If the configuration was disabled, the module default command on it will enable this configuration.

Example:

SCPI>>syst:mod:def?

<<" M9290A_US00000001"

SCPI>>syst:mod:enab "M9290A_US00000002",0

SCPI>>syst:mod:enab? "M9290A_US00000002"

<<0

SCPI>>syst:mod:def "M9290A_US00000002"

SCPI>>syst:mod:enab? "M9290A_US00000002"

<<1

SCPI>>syst:mod:def?

<<" M9290A_US00000002"

Mode	All
Remote Command	:SYSTem:MODule:DEFault?

	:SYSTem:MODule:DEFault "<mnemonic>"
Example	:SYST:MOD:DEF? :SYST:MOD:DEF "M9290A_US0000001"
Preset	Not affected by Preset, reset to "Left" with Restore System Defaults Misc.
State Saved	No
Initial S/W Revision	A.13.80

Module Model Number (Remote Command Only)

Query only. The query ":SYST:MODule:MODEl?" will return model number of the current module.

Mode	All
Remote Command	:SYSTem:MODule:MODEl?
Example	:SYSTem:MODule:MODEl?
Notes	This query will return model number. e.g. "M9420A"
Preset	Not affected by Preset,
State Saved	No
Initial S/W Revision	E.14.14

Module Model Serial Number (Remote Command Only)

Query only. The query ":SYST: MODule:SERial?" will return model serial number of the current module.

Mode	All
Remote Command	:SYSTem:MODule:SERial?
Example	:SYSTem:MODule:SERial?
Notes	This query will return model serial number like "SN12344321"
Preset	Not affected by Preset
State Saved	No
Initial S/W Revision	E.14.14

Power On

Enables you to select how the instrument should power on. The options are: Mode and Input/Output Defaults, User Preset and Last State.

NOTE

In products that run multiple instances of the X-Series Application, the same Power On type is shared between all the instances.

Key Path	System
Mode	All
Remote Command	:SYSTem:PON:TYPE MODE USER LAST :SYSTem:PON:TYPE?
Example	:SYST:PON:TYPE MODE
Preset	This is unaffected by a Preset but is set to Mode on a “Restore System Defaults->All”
State Saved	No
Backwards Compatibility SCPI	:SYSTem:PON:TYPE PRESet the “PRESet” parameter is supported for backward compatibility only and behaves the same as MODE.
Backwards Compatibility Notes	The Preset Type key in legacy analyzers has been removed, and the Power On toggle key has been replaced by this 1-of-N key in the System menu.
Initial S/W Revision	Prior to A.02.00

Mode and Input/Output Defaults

When the analyzer is powered on in Mode and Input/Output Defaults, it performs a Restore Mode Defaults to all modes in the instrument and also performs a Restore Input/Output Defaults.

Persistent parameters (such as Amplitude Correction tables or Limit tables) are not affected at power on, even though they are normally cleared by Restore Input/Output Defaults and/or Restore Mode Defaults.

Key Path	System, Power On
Mode	All
Example	SYST:PON:TYPE MODE
Readback Text	Defaults
Initial S/W Revision	Prior to A.02.00

User Preset

Sets Power On to User Preset. When the analyzer is powered on in User Preset, it will User Preset each mode and switch to the power-on mode. Power On User Preset will not affect any settings beyond what a normal User Preset affects.

NOTE

In products that run multiple instances of the X-Series Application, the same User Preset is shared between all the instances.

An instrument could never power up for the first time in User Preset.

Key Path	System, Power On
Mode	All

Example	SYST:PON:TYPE USER
Readback Text	User Preset
Backwards Compatibility Notes	Power On User Preset will cause the instrument to power up in the power-on mode, not the last mode the instrument was in prior to shut down. Also, Power On User Preset will User Preset all modes. This does not exactly match legacy behavior.
Initial S/W Revision	Prior to A.02.00

Last State

Sets Power On to **Last**. When the analyzer is powered on, it will put all modes in the last state they were in prior to when the analyzer was put into Power Standby and it will wake up in the mode it was last in prior to powering off the instrument. The saving of the active mode prior to shutdown happens behind the scenes when a controlled shutdown is requested by using the front panel power Standby key or by using the remote command SYSTem:PDOWn. The non-active modes are saved as they are deactivated and recalled by Power On Last State.

NOTE

In products that run multiple instances of the X-Series Application, each instance has a unique Last State. An instrument can never power up for the first time in Last.

If line power to the analyzer is interrupted, for example by pulling the line cord plug or by switching off power to a test rack, Power On Last State may not work properly. For proper operation, Power On Last State depends on you shutting down the instrument using the Standby key or the SYSTem:PDOWn SCPI command. This will ensure the last state of each mode is saved and can be recalled during a power up.

Key Path	System, Power On
Mode	All
Example	SYST:PON:TYPE LAST
Notes	Power on Last State only works if you have done a controlled shutdown prior to powering on in Last. If a controlled shutdown is not done when in Power On Last State, the instrument will power up in the last active mode, but it may not power up in the active mode's last state. If an invalid mode state is detected, a Mode Preset will occur. To control the shutdown under remote control use the :SYSTem:PDOWn command.
Readback Text	Last State
Backwards Compatibility Notes	It is no longer possible to power-up the analyzer in the last mode the analyzer was running with that mode in the preset state. (ESA/PSA SYST:PRESET:TYPE MODE with SYST:PON:PRESET) You can power-on the analyzer in the last mode the instrument was running in its last state (SYST:PON:TYPE LAST), or you can specify the mode to power-up in its preset state (SYST:PON:MODE <mode>).
Initial S/W Revision	Prior to A.02.00

Power On Application

Accesses a menu that lists the available Modes and lets you select which Mode is to be the power-on application.

This application is used for Power On Type “Mode and Input/Output Defaults” and Restore System Defaults All.

NOTE

In products that run multiple instances of the X-Series Application, the same Power On Application is shared between all the instances.

Key Path	System, Power On
Mode	All
Remote Command	:SYSTem:PON:MODE SA BASIC ADEMOD NFIGURE PNOISE CDMA2K TDSCDMA VSA VSA89601 WCDMA WIMAXOFDMA :SYSTem:PON:MODE?
Example	SYST:PON:MODE SA
Notes	The list of possible modes (and remote parameters) to choose from is dependent on which modes are installed in the instrument.
Preset	This is unaffected by a Preset but is set on a “Restore System Defaults->All” to: SEQAN
State Saved	No
Initial S/W Revision	Prior to A.02.00

Configure Applications

The Configure Applications utility can be used to:

- select applications for preload
- determine how many applications can fit in memory at one time
- specify the order of the Modes in the Mode menu.

This utility consists of a window with instructions, a set of “Select Application” checkboxes, a “fuel bar” style memory gauge, and keys that help you set up your configuration.

NOTE

In products that run multiple instances of the X-Series Application, the same Configure Applications Utility is shared between all the instances.

For more information, see the following topics:

["Preloading Applications" on page 208](#)

["Access to Configure Applications utility" on page 208](#)

["Virtual memory usage" on page 208](#)

Key Path	System, Power On
Example	:SYST:SHOW CAPP Displays the Config Applications screen
Initial S/W Revision	A.02.00

Preloading Applications

During runtime, if a Mode that is not preloaded is selected using the Mode menu or sending SCPI commands, there will be a pause while the Application is loaded. During this pause a message that says “Loading application, please wait ...” is displayed. Once loaded, the application stays loaded, so the next time you select it during a session, there is no delay.

Preloading enables you to “preload” at startup, to eliminate the runtime delay. Preloading an application will cause it to be loaded into the analyzer’s memory when the analyzer program starts up. If you do this, the delay will increase the time it takes to start up the analyzer program, but this may be preferable to having to wait the first time you select an application. Note that, once an application is loaded into memory, it cannot be unloaded without exiting and restarting the analyzer program.

Note that there are more applications available for the X-Series than can fit into Windows Virtual Memory. By allowing you to choose which licensed applications to load at startup, the Configure Applications utility allows you to make optimal use of your memory.

Access to Configure Applications utility

A version of the utility runs the first time you power up the analyzer after purchasing it from Keysight. The utility automatically configures preloads so that as many licensed applications as possible are preloaded while keeping the total estimated virtual memory usage below the limit. This auto-configuration only takes place at the very first run, and after analyzer software upgrades.

You may, at any time, manually call up the Configure Applications utility by pressing System, Power On, Configure Applications, to find a configuration that works best for you, and then restart the analyzer program.

The utility may also be called if, during operation of the analyzer, you attempt to load more applications than can fit in memory at once.

Virtual memory usage

There are more applications available for the X-Series than can fit into memory at any one time, so the Configure Applications utility includes a memory tracker that serves two purposes:

1. It will not let you preload more applications than will fit into memory at once.
2. You can determine how many of your favorite applications can reside in memory at one time.

The utility provides a graphical representation of the amount of memory (note that the memory in question here is Virtual memory and is a limitation imposed by the operating system, not by the amount of physical memory you have in your analyzer). You select applications to preload by checking the boxes on the left. Checked applications preload at startup. The colored fuel bar indicates the total memory required when all the checked applications are loaded (either preloaded or selected during runtime).

Here is what the fuel bar colors mean:

RED: the applications you have selected cannot all fit into the analyzer’s memory. You must deselect applications until the fuel bar turns yellow.

YELLOW: the applications you have selected can all fit into the analyzer’s memory, but there is less than 10% of the memory left, probably not enough to load any other applications, either via preload or by selecting a Mode while the analyzer is running..

GREEN: The indicator is green when <90% of the memory limit is consumed. This means the applications you have selected can all fit into the analyzer's memory with room to spare. You will likely be able to load one or more other applications without running out of memory.

Select All

Marks all applications in the selection list. This allows you to enable all applications licensed on the instrument for pre-loading, or is a convenience for selecting all applications in one operation and then letting you deselect individual applications.

Key Path	System, Power On, Configure Applications
Initial S/W Revision	A.02.00

Deselect All

Clears the marks from all applications in the selection list, except the Power On application. The Power On application cannot be eliminated from the pre-load list.

Key Path	System, Power On, Configure Applications
Initial S/W Revision	A.02.00

Move Up

The application list is the order that applications appear in the Mode Menu. This key enables you to shift the selected application up in the list, thus moving the selected application earlier in the Mode Menu.

Key Path	System, Power On, Configure Applications
Initial S/W Revision	A.02.00

Move Down

The application list is the order that applications appear in the Mode Menu. This key enables you to shift the selected application down in the list, thus moving the selected application later in the Mode Menu.

Key Path	System, Power On, Configure Applications
Initial S/W Revision	A.02.00

Select/Deselect

Toggles the currently highlighted application in the list.

Key Path	System, Power On, Configure Applications
Initial S/W Revision	A.02.00

Save Changes and Exit

Applies the configuration of the applications list. The marked applications will be pre-loaded in memory the next time the instrument application is started, and the order of the applications in the list will be the order of the applications in the Mode Menu.

After saving your changes, the analyzer asks you if you would like it to restart so that your changes can take effect (see dialog box, below). If you choose not to restart, the changes will not take affect until the next time you shut down and restart the analyzer.

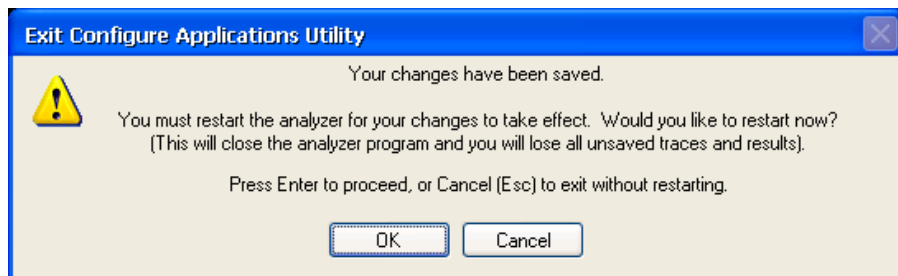

Key Path	System, Power On, Configure Applications
Remote Command	:SYSTem:PUP:PROcEss
Example	:SYST:PUP:PROC This is the SCPI command for restarting the analyzer. You must Wait after this command for the instrument application to restart
Notes	The softkey will be grayed-out when the virtual memory of the selected applications exceeds 100% of the limit.
Notes	You cannot use *WAI or *OPC? to synchronize operation after a restart. This command stops and restarts the instrument application, thus the SCPI operation is terminated and restarted. A remote program must use fixed wait time to resume sending commands to the instrument. The wait time will be dependent upon which applications are pre-loaded.
Initial S/W Revision	A.02.00
Modified at S/W Revision	A.04.00

Exit Without Saving

Pressing this key will exit the Configure Applications utility without saving your changes.

Key Path	System, Power On, Configure Applications
Initial S/W Revision	A.02.00
Modified at S/W Revision	A.04.00

Restore Power On Defaults

This selection causes the Power On Type and Power On Application settings to be a reset to their default values. This level of Restore System Defaults does not affect any other system settings, mode settings and

does not cause a mode switch. The Power On key, under the Restore System Defaults menu, causes the same action.

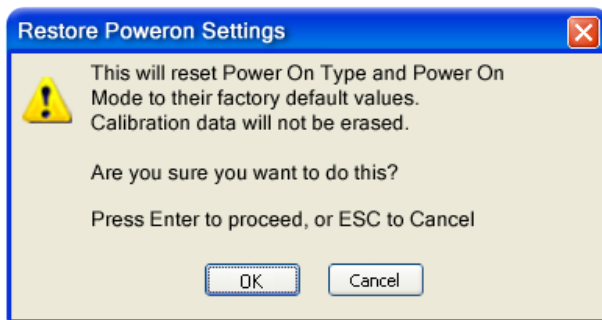

If you press any key other than OK or Enter, it is construed as a Cancel, because the only path that will actually cause the reset to be executed is through OK or Enter.

Key Path	System, Power On
Example	:SYST:DEF PON
Initial S/W Revision	Prior to A.02.00

Configure Applications - Instrument boot-up

At start-up of the analyzer program a dialog box similar to the one under the System, Power On, Configure Applications key will be displayed allowing you to choose which licensed applications are to be loaded. This dialog will only be displayed if the memory required to pre-load all of the licensed applications exceeds the Virtual Memory available.

Configure Applications - Windows desktop

The Configure Applications Utility may be run from the Windows Desktop. The utility is launched by double-



clicking the icon on the desktop, which brings-up a dialog box similar to the one under the System, Power On, Configure Applications key, allowing you to choose which licensed applications are to be loaded when the analyzer program starts up. This dialog box has mouse buttons on it that do the job the softkeys normally do in the System, Power On, Configure Applications menu.

NOTE

In products that run multiple instances of the X-Series Application, the same Configure Applications Utility launched from the Windows Desktop will apply to all the instances.

Configure Applications - Remote Commands

The following topics provide details on using remote commands to configure the list of applications you want to load into the instrument memory or query the Virtual Memory utilization for your applications.

- ["Configuration list \(Remote Command Only\)" on page 212](#)
- ["Configuration Memory Available \(Remote Command Only\)" on page 212](#)

- "Configuration Memory Total (Remote Command Only)" on page 212
- "Configuration Memory Used (Remote Command Only)" on page 212
- "Configuration Application Memory (Remote Command Only)" on page 213

Configuration list (Remote Command Only)

This remote command is used to set or query the list of applications to be loaded in-memory.

Remote Command	:SYSTem:PON:APPLication:LLISt <string of INSTRument:SElect names> :SYSTem:PON:APPLication:LLISt?
Example	:SYST:PON:APPL:LLIS "SA,BASIC,WCDMA"
Notes	<string of INSTRument:SElect names> are from the enums of the :INSTRument:SElect command. The order of the <INSTRument:SElect names> is the order that the applications are loaded into memory, and the order that they appear in the Mode Menu. Error message -225 "Out of Memory" is reported when more applications are listed than can reside in Virtual Memory. When this occurs, the existing applications load list is unchanged.
Preset	Not affected by Preset
State Saved	Not saved in instrument state
Initial S/W Revision	A.02.00

Configuration Memory Available (Remote Command Only)

This remote command is used to query the amount of Virtual Memory remaining.

Remote Command	:SYSTem:PON:APPLication:VMEMory[:AVAILable]?
Example	:SYST:PON:APPL:VMEM?
Preset	Not affected by Preset
Initial S/W Revision	A.02.00

Configuration Memory Total (Remote Command Only)

This remote command is used to query the limit of Virtual Memory allowed for applications.

Remote Command	:SYSTem:PON:APPLication:VMEMory:TOTAL?
Example	:SYST:PON:APPL:VMEM:TOT?
Preset	Not affected by Preset
Initial S/W Revision	A.02.00

Configuration Memory Used (Remote Command Only)

This remote command is a query of the amount of Virtual Memory used by all measurement applications.

Remote Command	:SYSTem:PON:APPLication:VMEMory:USED?
Example	:SYST:PON:APPL:VMEM:USED?
Preset	Not affected by Preset
Initial S/W Revision	A.02.00

Configuration Application Memory (Remote Command Only)

This remote command is used to query the amount of Virtual Memory a particular application consumes.

Remote Command	:SYSTem:PON:APPLication:VMEMory:USED:NAME? <INSTrument:SElect name>
Example	:SYST:PON:APPL:VMEM:USED:NAME? CDMA2K
Notes	<INSTrument:SElect name> is from the enums of the :INSTrument:SElect command Value returned will be 0 (zero) if the name provided is invalid.
Preset	Not affected by Preset
Initial S/W Revision	Prior to A.02.00

Alignments

The Alignments Menu controls and displays the automatic alignment of the instrument, and provides the ability to restore the default alignment values.

The current setting of the alignment system is displayed in the system Settings Panel along the top of the display, including a warning icon for conditions that may cause specifications to be impacted.



Key Path	System
Initial S/W Revision	Prior to A.02.00

Align Now

Accesses alignment processes that are immediate action operations. They perform complete operations and run until they are complete.

Key Path	System, Alignments
Initial S/W Revision	Prior to A.02.00

All (Daily use)

Immediately executes an alignment of all subsystems which includes both the source and the analyzer in the TRX module. The “All” alignment is sufficient to maintain specified performance, provided that (1) the

TRX's internal temperature has not drifted more than +/-5 degree C since the previous alignment, and (2) no more than 8 hours have elapsed since the previous "All" alignment., and (3) no more than 1 week has elapsed since these three alignments have all been run: IF, RF, and Source, and (4) a 45 minute warm-up period between power-up of the TRX and invoking the "All" alignment. The instrument stops any measurement currently underway, performs the alignment, then restarts the measurement from the beginning (similar to pressing the Restart key).

If an interfering user signal is present at the RF Input, the alignment is performed on all subsystems except the RF. After completion, the Error Condition message "Align skipped: 50 MHz interference" or "Align skipped: 4.8 GHz interference" is generated. In addition the Error Condition message "Align Now, RF required" is generated, and bits 11 and 12 are set in the Status Questionable Calibration register.

The query form of the remote commands (:CALibration[:ALL]? or *CAL?) invokes the alignment of all subsystems and returns a success or failure value. An interfering user signal is not grounds for failure; if the alignment was able to succeed on all portions but unable to align the RF because of an interfering signal, the resultant will be the success value.

Successful completion of Align Now, All will clear the "Align Now, All required" Error Condition, and clear bit 14 in the Status Questionable Calibration register. It will also begin the elapsed time counter for Last Align Now, All Time, and capture the Last Align Now, All Temperature.

If the Align RF subsystem succeeded in aligning (no interfering signal present), the elapsed time counter begins for Last Align Now, RF Time, and the temperature is captured for the Last Align Now, RF Temperature. In addition the Error Conditions "Align skipped: 50 MHz interference" and "Align skipped: 4.8 GHz interference" are cleared, the Error Condition "Align Now, RF required" is cleared, and bits 11 and 12 are cleared in the Status Questionable Calibration register

Align Now, All can be interrupted by pressing the Cancel (ESC) front-panel key or remotely with Device Clear followed by the :ABORt SCPI command. When this occurs the Error Condition message "Align Now, All required" is generated, and bit 14 is set in the Status Questionable Condition register. This is because new alignment data may be employed for an individual subsystem, but not a cohesive set of data for all subsystems.

In many cases, you might find it more convenient to change alignments to Normal, instead of executing Align Now, All. When the Auto Align process transitions to Normal, the analyzer will immediately start to update only the alignments that have expired, thus efficiently restoring the alignment process.

NOTE

In EXM/M9420A, Source ARB play will be turned off and the source states will not be restored after Align Now, All.

Key Path	System, Alignments, Align Now
Mode	All
Remote Command	:CALibration[:ALL] :CALibration[:ALL]?
Example	:CAL
Notes	:CALibration[:ALL]? returns 0 if successful :CALibration[:ALL]? returns 1 if failed :CALibration[:ALL]? is the same as *CAL?

	<p>While Align Now, All is performing the alignment, bit 0 in the Status Operation register is set. Completion, or termination, will clear bit 0 in the Status Operation register.</p> <p>This command is sequential; it must complete before further SCPI commands are processed. Interrupting the alignment from remote is accomplished by invoking Device Clear followed by the :ABORt command.</p> <p>Successful completion will clear bit 14 in the Status Questionable Calibration register.</p> <p>An interfering user signal is not grounds for failure of Align Now, All. However, bits 11 and 12 are set in the Status Questionable Calibration register to indicate Align Now, RF is required.</p> <p>An interfering user supplied signal will result in the instrument requiring an Align Now, RF with the interfering signal removed.</p>
Couplings	<p>Initializes the time for the Last Align Now, All Time.</p> <p>Records the temperature for the Last Align Now, All Temperature.</p> <p>If Align RF component succeeded, initializes the time for the Last Align Now, RF Time.</p> <p>If Align RF component succeeded, records the temperature for the Last Align Now, RF Temperature.</p>
Status Bits/OPC dependencies	Bits 11, 12, or 14 may be set in the Status Questionable Calibration register.
Initial S/W Revision	Prior to A.02.00

Mode	All
Remote Command	*CAL?
Example	*CAL?
Notes	<p>*CAL? returns 0 if successful</p> <p>*CAL? returns 1 if failed</p> <p>:CALibration[:ALL]? is the same as *CAL?</p> <p>See additional remarks described with :CALibration[:ALL]?</p> <p>Everything about :CALibration[:ALL]? is synonymous with *CAL? including all conditions, status register bits, and couplings</p>
Initial S/W Revision	Prior to A.02.00

Mode	All
Remote Command	:CALibration[:ALL]:NPENding
Example	CAL:NPEN
Notes	<p>:CALibration[:ALL]:NPENding is the same as :CALibration[:ALL] including all conditions, status register bits, except this scpi command does not BLOCK the scpi session, so the user should use status register bits to query if the calibration is successfully completed or not.</p> <p>Typical usage is:</p> <ol style="list-style-type: none"> 1) :CALibration:ALL:NPENding (Start a calibration) 2) :STATus:OPERation:CONDition? (Check if the calibration is completed or not, If bit 0 is set, then the system is doing calibration, the user should repeat this scpi query until the bit is cleared)

	3):STATus:QUEStionable:CALibration:CONDition? (Check if if there are any errors/failures in previous calibration procedure)
Initial S/W Revision	X.14.20

All but RF

Immediately executes an alignment of all subsystems except the RF subsystem which includes both the source and the analyzer in the TRX module . The instrument will stop any measurement currently underway, perform the alignment, and then restart the measurement from the beginning (similar to pressing the Restart key). This can be used to align portions of the instrument that are not impacted by an interfering user input signal.

This operation might be chosen instead of All if you do not want the device under test to experience a large change in input impedance, such as a temporary open circuit at the analyzer input.

The query form of the remote commands (:CALibration:NRF?) will invoke the alignment and return a success or failure value.

Successful completion of Align Now, All but RF will clear the “Align Now, All required” Error Condition, and clear bit 14 in the Status Questionable Calibration register. If “Align Now, All required” was in effect prior to executing the All but RF, the Error Condition message “Align Now, RF required” is generated and bit 12 in the Status Questionable Calibration register is set. It will also begin the elapsed time counter for Last Align Now, All Time, and capture the Last Align Now, All Temperature.

Align Now, All but RF can be interrupted by pressing the Cancel (ESC) front-panel key or remotely with Device Clear followed by the :ABORt SCPI command. When this occurs the Error Condition message “Align Now, All required” is generated, and bit 14 is set in the Status Questionable Condition register. This is because new alignment data may be used for an individual subsystem, but not a full new set of data for all subsystems.

NOTE

In EXM/M9420A, Source ARB play will be turned off and the source states will not be restored after Align Now, All but RF.

Key Path	System, Alignments, Align Now
Mode	All
Remote Command	:CALibration:NRF :CALibration:NRF?
Example	:CAL:NRF
Notes	:CALibration:NRF? returns 0 if successful :CALibration:NRF? returns 1 if failed While Align Now, All but RF is performing the alignment, bit 0 in the Status Operation register is set. Completion, or termination, will clear bit 0 in the Status Operation register. This command is sequential; it must complete before further SCPI commands are processed. Interrupting the alignment from remote is accomplished by invoking Device Clear followed by the :ABORt command. Successful completion will clear bit 14 in the Status Questionable Calibration register and set bit 12

	if invoked with “Align Now, All required”.
Couplings	Initializes the time for the Last Align Now, All Time. Records the temperature for the Last Align Now, All Temperature.
Status Bits/OPC dependencies	Bits 12 or 14 may be set in the Status Questionable Calibration register.
Initial S/W Revision	Prior to A.02.00
Mode	All
Remote Command	:CALibration:NRF:NPENding
Example	CAL:NRF:NPEN
Notes	:CALibration:NRF:NPENding is the same as :CALibration:NRF including all conditions, status register bits, except that this scpi command does not BLOCK the scpi session, so the user should use status register bits to query if the calibration is successfully completed or not. Typical usage is: 1):CALibration:NRF:NPENding (start theAll but RF calibration) 2):STATus:OPERation:CONDition? (If bit 0 is set, then the system is doing calibration, the user should do re-query until this bit is cleared) 3):STATus:QUESTionable:CALibration:CONDition? (to check if there are any errors/failures in previous calibration procedure)
Initial S/W Revision	X.14.20

RF (Weekly use)

Immediately executes an alignment of the RF subsystem which includes both the source and the analyzer in the TRX module . The instrument stops any measurement currently underway, performs the alignment, then restarts the measurement from the beginning (similar to pressing the Restart key).

This alignment corrects slow-rate drift which does not impair specifications for time periods shorter than one week. Thus, it is required to perform this alignment on a weekly basis to maintain specifications. This alignment typically takes >2 minutes to complete.

This operation might be desirable if the alignments had been set to not include RF alignments, or if previous RF alignments could not complete because of interference which has since been removed.

If an interfering user signal is present at the RF Input, the alignment will terminate and generate the Error Condition message “Align skipped: 50 MHz interference” or “Align skipped: 4.8 GHz interference”, and Error Condition “Align Now, RF required”. In addition, bits 11 and 12 will be set in the Status Questionable Calibration register.

The query form of the remote commands (:CALibration:RF?) will invoke the alignment of the RF subsystem and return a success or failure value. An interfering user signal is grounds for failure.

Successful completion of Align Now, RF will begin the elapsed time counter for Last Align Now, RF Time, and capture the Last Align Now, RF Temperature.

Align Now, RF can be interrupted by pressing the Cancel (ESC) front-panel key or remotely with Device Clear followed by the :ABORt SCPI command. When this occurs, the Error Condition message “Align Now, RF required” is generated, and bit 12 is set in the Status Questionable Condition register. None of the new alignment data is used.

NOTE

In EXM/M9420A, Source ARB play will be turned off and the source states will not be restored after Align Now, All but RF.

Key Path	System, Alignments, Align Now
Mode	All
Remote Command	:CALibration:RF :CALibration:RF?
Example	:CAL:RF
Notes	:CALibration:RF? returns 0 if successful :CALibration:RF? returns 1 if failed (including interfering user signal) While Align Now, RF is performing the alignment, bit 0 in the Status Operation register is set. Completion, or termination, will clear bit 0 in the Status Operation register. This command is sequential; it must complete before further SCPI commands are processed. Interrupting the alignment from remote is accomplished by invoking Device Clear followed by the :ABORt command. Successful completion clears the Error Conditions “Align skipped: 50 MHz interference” and “Align skipped: 4800 MHz interference” and the Error Conditions “Align RF failed” and “Align Now, RF required”, and clears bits 3, 11, and 12 in the Status Questionable Calibration register. A failure encountered during alignment will generate the Error Condition message “Align RF failed” and set bit 3 in the Status Questionable Calibration register. An interfering user signal will result in bits 11 and 12 to be set in the Status Questionable Calibration register to indicate Align Now, RF is required. An interfering user supplied signal will result in the instrument requiring an Align Now, RF with the interfering signal removed.
Couplings	Initializes the time for the Last Align Now, RF Time. Records the temperature for the Last Align Now, RF Temperature.
Status Bits/OPC dependencies	Bits 11, 12, or 14 may be set in the Status Questionable Calibration register.
Initial S/W Revision	Prior to A.02.00

Mode	All
Remote Command	:CALibration:RF:NPENding
Example	CAL:RF:NPEN
Notes	:CALibration:RF:NPENding is the same as :CALibration:RF including all conditions, status register bits, except that this scpi command does not BLOCK the scpi

session, so the user should use status register bits to query if the calibration is successfully completed or not.

Typical usage is:

1):CALibration:RF:NPENding (Start a RF calibration)

2):STATus:OPERation:CONDition? (If bit 0 is set, then the system is doing calibration, the user should do re-query until this bit is cleared)

3):STATus:QUESTionable:CALibration:CONDition? (to check if there are any errors/failures in previous calibration procedure)

Initial S/W Revision	X.14.20
----------------------	---------

Source (Weekly use)

Accesses source alignment processes that are immediate action operations. They perform complete operations and run until they are complete.

Immediately executes an IQ alignment, and power level alignment. The instrument stops any sequence of the source, performs the alignment, then restarts the sequence from the beginning.

This alignment corrects slow-rate drift which does not impair specifications for time periods shorter than one week. Thus, it is required to perform this alignment on a weekly basis to maintain specifications. This alignment typically takes >2 minutes to complete.

There is no alert available for the source alignment. The operators have the responsibility to check temperature shift since last Align Now, Source to determine if the source alignment needs to be executed.

Key Path	System, Alignments, Align Now
Mode	All
Remote Command	:CALibration:INTernal:SOURce[:ALL] :CALibration:INTernal:SOURce[:ALL]?
Example	:CAL:INT:SOUR
Notes	:CAL:SOUR? Initiates an Alignment and returns 0 if successful :CAL:SOUR? Initiates an Alignment and returns 1 if failed
Couplings	Initializes the time for the Last Align Source Now, All Time. Records the temperature for the Last Align Source Now, All Temperature.
Initial S/W Revision	A.05.00

Mode	All
Remote Command	:CALibration:INTernal:SOURce[:ALL]:NPENding
Example	CAL:INT:SOUR:NPEN
Notes	:CALibration:INTernal:SOURce[:ALL]:NPENding is the same as :CALibration:INTernal:SOURce[:ALL] including all conditions, status register bits, except that this scpi command does not BLOCK the scpi session, so the user should use status register bits to query if the calibration is successfully

completed or not.

Typical usage is:

- 1):CALibration:INTernal:SOURce:NPending (start an internal source calibration)
- 2):STATus:OPERation:CONDition? (Check if the calibration is completed or not, If bit 0 is set, then the system is doing calibration, the user should repeat this scpi query until the bit is cleared)
- 3):STATus:QUEStionable:CALibration:EXTended:FAILure:CONDition? (Check if bit 14 is set or not. If this bit is set, that means there are some errors in previous internal source calibration)

Initial S/W Revision X.14.20

Show Alignment Statistics

Shows alignment information you can use to ensure that the instrument is operating in a specific manner. The Show Alignment Statistics screen is where you can view time and temperature information.

Values which are displayed are only updated when the Show Alignment Statistics screen is invoked, they are not updated while the Show Alignment Statistics screen is being displayed. The remote commands that access this information obtain current values.

An example of the Show Alignment Statistics screen would be similar to:

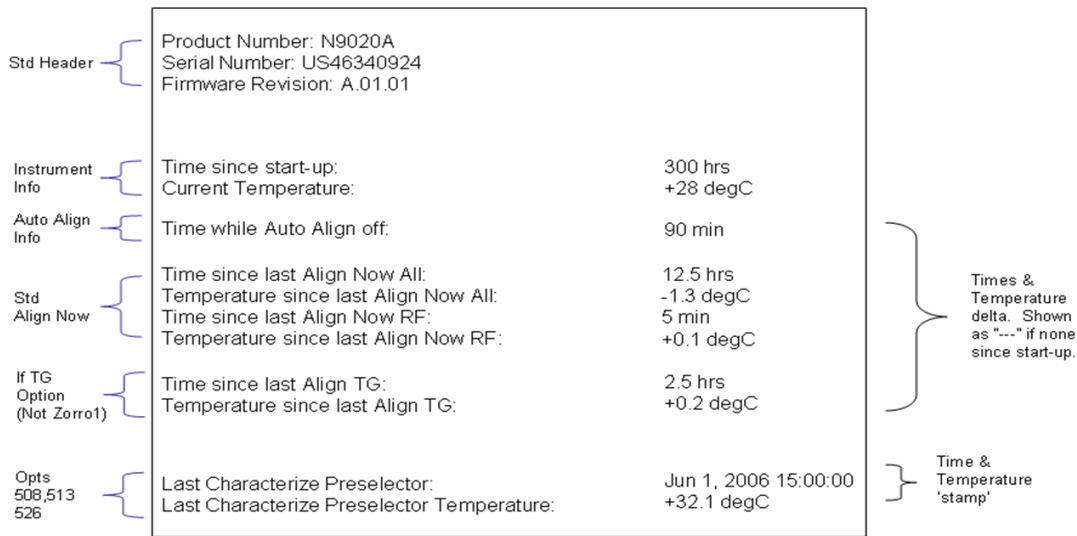

A successful Align Now, RF will set the Last Align RF temperature to the current temperature, and reset the Last Align RF time. A successful Align Now, All or Align Now, All but RF will set the Last Align Now All temperature to the current temperature, and reset the Last Align Now All time. A successful Align Now, All will also reset the Last Align RF items if the RF portion of the Align Now succeeded.

Key Path	System, Alignments
Mode	All
Notes	The values displayed on the screen are only updated upon entry to the screen and not updated while

	the screen is being displayed.
Initial S/W Revision	Prior to A.02.00

Key Path	Visual annotation in the Show Alignment Statistics screen
Mode	All
Remote Command	:SYSTem:PON:TIME?
Example	:SYST:PON:TIME?
Notes	Value is the time since the most recent start-up in seconds.
State Saved	No
Initial S/W Revision	Prior to A.02.00

Key Path	Visual annotation in the Show Alignment Statistics screen
Mode	All
Remote Command	:CALibration:TEMPerature:CURRent?
Example	:CAL:TEMP:CURR?
Notes	Value is in degrees Centigrade. Value is invalid if using default alignment data (Align Now, All required)
State Saved	No
Initial S/W Revision	Prior to A.02.00

Key Path	Visual annotation in the Show Alignment Statistics screen
Mode	All
Remote Command	:CALibration:TIME:LALL?
Example	:CAL:TIME:LALL?
Notes	Value is the elapsed time, in seconds, since the last successful Align Now, All or Align Now, All but RF was executed.
State Saved	No
Initial S/W Revision	Prior to A.02.00

Key Path	Visual annotation in the Show Alignment Statistics screen
Mode	All
Remote Command	:CALibration:TEMPerature:LALL?
Example	:CAL:TEMP:LALL?
Notes	Value is in degrees Centigrade at which the last successful Align Now, All or Align Now, All but RF

	was executed.
State Saved	No
Initial S/W Revision	Prior to A.02.00

Key Path	Visual annotation in the Show Alignment Statistics screen
Mode	All
Remote Command	:CALibration:TIME:LRF?
Example	:CAL:TIME:LRF?
Notes	Value is the elapsed time, in seconds, since the last successful Align Now, RF was executed, either individually or as a component of Align Now, All.
State Saved	No
Initial S/W Revision	Prior to A.02.00

Key Path	Visual annotation in the Show Alignment Statistics screen
Mode	All
Remote Command	:CALibration:TEMPerature:LRF?
Example	:CAL:TEMP:LRF?
Notes	Value is in degrees Centigrade at which the last successful Align Now, RF was executed, either individually or as a component of Align Now, All.
State Saved	No
Initial S/W Revision	Prior to A.02.00

Key Path	SCPI Only
Mode	All
Remote Command	:CALibration:TIME:LIF?
Example	:CAL:TIME:LIF?
Notes	Value is the elapsed time, in seconds, since the last successful Align IF was executed.
State Saved	No
Initial S/W Revision	A.14.50

Key Path	SCPI Only
Mode	All
Remote Command	:CALibration:TEMPerature:LIF?

Example	:CAL:TEMP:LIF?
Notes	Value is in degrees Centigrade at which the last successful Align IF was executed.
State Saved	No
Initial S/W Revision	A.14.50

Key Path	Visual annotation in the Show Alignment Statistics screen
Mode	All
Remote Command	:CALibration:TIME:SOURce:LALL?
Example	:CAL:TIME:SOUR:LALL?
Notes	Value is the date and time of the last successful Align Now, Source was performed on the instrument.
State Saved	No
Initial S/W Revision	A.05.00

Key Path	Visual annotation in the Show Alignment Statistics screen
Mode	All
Remote Command	:CALibration:TEMPerature:SOURce: LALL?
Example	:CAL:TEMP:SOUR:LALL?
Notes	Value is in degrees Centigrade at which the last successful Align Now, Source was performed on the instrument.
State Saved	No
Initial S/W Revision	A.05.00

Restore Align Defaults

Initializes the alignment user interface settings, not alignment data, to the factory default values. Align Now, All must be executed if the value of the Timebase DAC results in a change.

For front panel operation, you are prompted to confirm action before setting the alignment parameters to factory defaults:

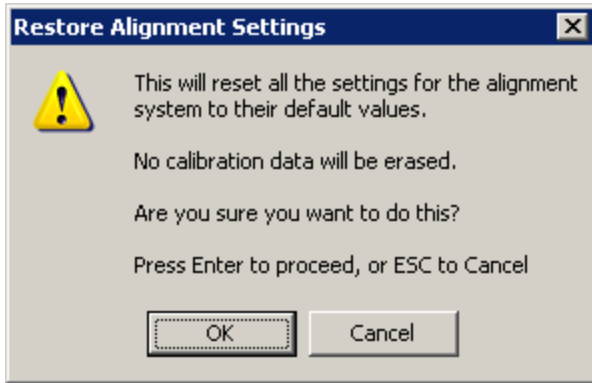

The parameters affected are:

Parameter	Setting
Timebase DAC	Calibrated
Timebase DAC setting	Calibrated value
Auto Align State	Normal (if the instrument is not operating with default alignment data, Off otherwise)
Auto Align All but RF	Off
Auto Align Alert	Time & Temperature

Key Path	System, Alignments
Mode	All
Example	:SYST:DEF ALIG
Notes	Alignment processing that results as the transition to Auto Alignment Normal will be executed sequentially; thus *OPC? or *WAI will wait until the alignment processing is complete.
Initial S/W Revision	Prior to A.02.00

Execute Expired Alignments (Remote Command Only)

Alignments can be expired in the situation where Auto Align is in the state of Partial or Off. This feature runs the alignments that have expired. This is different than performing an Align All, Now operation. Align All, Now performs an alignment of all subsystems regardless of whether they are needed or not, with Execute Expired Alignments, only the individual subsystems that have become due are aligned.

Mode	All
Remote Command	:CALibration:EXPIred?
Example	:CAL:EXP?
Notes	:CALibration:EXPIred? returns 0 if successful :CALibration:EXPIred? returns 1 if failed
Initial S/W Revision	Prior to A.02.00

I/O Config

Activates a menu for identifying and changing the I/O configuration for remote control.

Key Path	System
Initial S/W Revision	Prior to A.02.00

SCPI LAN

Activates a menu for identifying and changing the SCPI over a LAN configuration. There are a number of different ways to send SCPI remote commands to the instrument over LAN. It can be a problem to have multiple users simultaneously accessing the instrument over the LAN. These keys limit that somewhat by disabling the telnet, socket, and/or SICL capability.

NOTE

By default settings: Telnet port 5023, socket port 5025, SICL server 0 and HiSLIP server 0 will be assigned to first instance; Telnet port 5123, socket port 5125, SICL server 1 and HiSLIP server 1 will be assigned to second instance; Telnet port 5223, socket port 5225, SICL server 2 and HiSLIP server 2 will be assigned to third instance; Telnet port 5323, socket port 5325, SICL server 3 and HiSLIP server 3 will be assigned to the fourth instance.

The Telnet port, socket port, physics port and HiSLIP server can also be set on the LaunchModularSA tool Setting panel.

Key Path	System, I/O Config
Initial S/W Revision	Prior to A.02.00

SCPI Telnet

Turns the SCPI LAN telnet capability On or Off allowing you to limit SCPI access over LAN through telnet.

Key Path	System, I/O Config, SCPI LAN
Mode	All
Remote Command	:SYSTem:COMMunicate:LAN:SCPI:TELNet:ENABle OFF ON 0 1 :SYSTem:COMMunicate:LAN:SCPI:TELNet:ENABle?
Example	:SYST:COMM:LAN:SCPI:TELN:ENAB OFF
Preset	This is unaffected by Preset but is set to ON with a "Restore System Defaults->Misc"
State Saved	No
Range	On Off
Initial S/W Revision	Prior to A.02.00

SCPI Socket

Turns the capability of establishing Socket LAN sessions On or Off. This allows you to limit SCPI access over LAN through socket sessions.

Key Path	System, I/O Config, SCPI LAN
Mode	All
Remote Command	:SYSTem:COMMunicate:LAN:SCPI:SOCKet:ENABle OFF ON 0 1 :SYSTem:COMMunicate:LAN:SCPI:SOCKet:ENABle?
Example	:SYST:COMM:LAN:SCPI:SOCK:ENAB OFF
Preset	This is unaffected by a Preset but is set to ON with a "Restore System Defaults->Misc"
State Saved	No
Range	On Off
Initial S/W Revision	Prior to A.02.00

SICL Server

Turns the SICL server capability On or Off, enabling you to limit SCPI access over LAN through the SICL server. (SICL IEEE 488.2 protocol.)

Parameter	Description	Setting
Maximum Connections	The maximum number of connections that can be accessed simultaneously	5
Instrument Name	The name (same as the remote SICL address) of your analyzer	inst0
Instrument Logical Unit	The unique integer assigned to your analyzer when using SICL LAN	8
Emulated GPIB Name	The name (same as the remote SICL address) of the device used when communicating with your analyzer	gpib7
Emulated GPIB Logical Unit	The unique integer assigned to your device when it is being controlled using SICL LAN	8
Emulated GPIB Address	The emulated GPIB address assigned to your transmitter tester when it is a SICL server (the same as your GPIB address)	18

Key Path	System, I/O Config, SCPI LAN
Mode	All
Remote Command	:SYSTem:COMMunicate:LAN:SCPI:SICL:ENABle OFF ON 0 1 :SYSTem:COMMunicate:LAN:SCPI:SICL:ENABle?
Example	:SYST:COMM:LAN:SCPI:SICL:ENAB OFF
Preset	This is unaffected by Preset, but is set to ON with a "Restore System Defaults->Misc"
State Saved	No
Range	On Off

Initial S/W Revision	Prior to A.02.00
----------------------	------------------

HiSLIP Server

Turns the HiSLIP server capability On or Off, enabling you to limit SCPI access over LAN through the HiSLIP server.

HiSLIP stands for High Speed LAN Instrument Protocol and is part of the IVI–6.1 specification.

Here is an example of a VISA connection string used to connect to the HiSLIP Server on an X-Series Spectrum Analyzer:

```
TCPIP0::a-n9030a-93016::hislip0::INSTR
```

In the example above, hislip0 is the HiSLIP device name that VISA users must include in their HiSLIP VISA Address strings. Your HiSLIP device name may be different depending on your VISA settings.

Key Path	System, I/O Config, SCPI LAN
Mode	All
Remote Command	:SYSTem:COMMunicate:LAN:SCPI:HISLip:ENABle OFF ON 0 1 :SYSTem:COMMunicate:LAN:SCPI:HISLip:ENABle?
Example	:SYST:COMM:LAN:SCPI:HISL:ENAB OFF
Preset	This is unaffected by Preset, but is set to ON with a “Restore System Defaults-> Misc”
State Saved	No
Range	On Off
Initial S/W Revision	A.11.00

SCPI Socket Control Port (Remote Command Only)

Returns the TCP/IP port number of the control socket associated with the SCPI socket session. This query enables you to obtain the unique port number to open when a device clear is to be sent to the instrument. Every time a connection is made to the SCPI socket, the instrument creates a peer control socket. The port number for this socket is random. The user must use this command to obtain the port number of the control socket. To force a device clear on this socket, open the port and send the string “DCL” to the instrument.

If this SCPI command is sent to a non SCPI Socket interface, then 0 is returned.

Mode	All
Remote Command	:SYSTem:COMMunicate:LAN:SCPI:SOCKet:CONTrol?
Example	:SYST:COMM:LAN:SCPI:SOCK:CONT?
Preset	This is unaffected by Preset or “Restore System Defaults-> Misc”.
State Saved	No
Range	0 to 65534

Min	0
Max	65534
Initial S/W Revision	Prior to A.02.00

System IDN Response

This key allows you to specify a response to the *IDN? query, or to return the analyzer to the Factory response if you have changed it.

To choose the factory-set response, press the Factory key.

To specify your own response, press the User key, and enter your desired response.

If your test software is expecting the response to indicate Agilent Technologies as the Manufacturer, you can conveniently configure the response by pressing the Agilent key.

Key Path	System, I/O Config
Mode	All
Remote Command	
Notes	<ul style="list-style-type: none"> • This affects the response given in all Modes of the Analyzer, unless the current Mode has also specified a custom response, in which case the current Mode's custom IDN response takes precedence over the System's, but only while that Mode is the current Mode.. • It survives shutdown and restart of the software and therefore survives a power cycle
Preset	This is unaffected by Preset but is set to Factory on a "Restore System Defaults->Misc"
State Saved	No
Initial S/W Revision	A.06.00
Modified at S/W Revision	x.14.50

Factory

This key selects the factory setting, for example:

"Keysight Technologies,M9420A,MY00012345, E.14.50"

where the fields are manufacturer, model number, serial number, firmware revision.

Note: In products that run multiple instances of the X-Series Application, all instances use the same factory System IDN response.

Key Path	System, I/O Config, IDN Response
Example	:SYST:IDN:CONF FACT
Initial S/W Revision	A.06.0

User

This key allows you to specify your own response to the *IDN? query. You may enter your desired response with the Alpha Editor or a plugin PC keyboard.

When you press this key, the active function becomes the current User string with the cursor at the end. This makes it easy to edit the existing string.

If you enter a null string (for example, by clearing the User String while editing and then pressing Done) the analyzer automatically reverts to the Factory setting.

Note: In products that run multiple instances of the X-Series Application, all instances use the same User System IDN response.

Key Path	System, I/O Config, IDN Response
Example	:SYST:IDN:CONF USER
Initial S/W Revision	A.06.00

SYSTEM:IDN Response setting (Remote command)

This SCPI command is used to set or clear the User SYSTEM:IDN response.

Remote Command	:SYSTem:IDN <string> :SYSTem:IDN?
Notes	<ul style="list-style-type: none"> • The format of the <string> must be four fields each separated by a comma, example: :SYST:IDN "XYZ Corp,Model 12,012345,A.01.01" • The four fields are <manufacturer>, <model number>, <serial number>, <firmware revision>. Thus, the text within a field cannot contain a comma. • This affects the response given in all Modes of the Analyzer, unless the current Mode has also specified a custom response, in which case the current Mode's custom IDN response takes precedence over the System's, but only while that Mode is the current Mode.. • It survives shutdown and restart of the software and therefore survives a power cycle • Null string as parameter restores the Factory setting, example: :SYST:IDN ""
Preset	This is unaffected by Preset but is set to the original factory setting on a "Restore System Defaults->Misc"
Initial S/W Revision	A.06.00

Lock Remote I/O Session (Remote Command only)

You can lock the SCPI control of the instrument to the I/O Interface and Session by performing a SYSTem:LOCK:REQuest? Query. This permits cooperative sharing of the instrument between multiple computers, or multiple sessions from the same computer.

NOTE

Use of cooperative sharing (locking) must take into account the properties of an interface, interfaces are either single session or multiple session:

NOTE	I n t e r f a c e	NOTE	Single Session	NOTE	Multiple Session
NOTE	G P I B	NOTE	✓	NOTE	
NOTE	U S B - 4 8 8	NOTE	✓	NOTE	
NOTE	L A N V X I - 1 1 (S I C L)	NOTE	✓	NOTE	
NOTE	L A N S o c k e t	NOTE		NOTE	✓

NOTE	L A N H i S L I P	NOTE	NOTE	✓
NOTE	L A N T e l n e t	NOTE	NOTE	✓

NOTE It is inappropriate to control the instrument from multiple computers (or multiple processes or threads of a single computer) when using single session interfaces. In particular, care must be taken when using LAN VXI-11 (SICL) interface that only a single computer (or single process or single thread) is controlling the instrument; if multiple computers are controlling the instrument responses may not result in expected operation.

It is not recommend to use VXI-11 with SCPI locking as multiple clients can simultaneously connect to the instrument. If VXI-11 is required then VISA locking must be used in addition to SCPI locking.

The recommended interface is LAN HiSLIP. Since HiSLIP is a multiple session interface, the controlling computer can send lock requests from multiple applications (or multiple threads of a single application) to permit cooperative sharing of the instrument.

Remote Command	SYSTem:LOCK:REQuest?
Example	SYST:LOCK:REQ?
Notes	<p>The command returns a 1 if the lock request is granted, 0 is returned if the request is denied.</p> <p>Single Session interfaces will always return 1 once the same interface has already received a lock request.</p> <p>Lock requests on an individual interface and session can be nested and each request will increase an internal lock count by 1. For every granted request, you will need to perform a SYSTem:LOCK:RELease to decrement the internal lock count to fully relinquish the lock.</p> <p>When the instrument is locked bit 0 is set in the Operation Instrument status register.</p> <p>Disconnecting the individual interface and session will release the lock if the lock is granted to the interface and session.</p> <p>A Device Clear over any interface and session will release the lock, regardless of the interface and session which obtained the lock.</p>

The following queries are permitted over any interface and session even if an interface has the instrument locked:

*IDN?

*OPT?

*STB?

*ESR?

:SYSTem:DATE?

:SYSTem:TIME?

:SYSTem:PON:TIME?

Queries in the :STATus subsystem

Queries in the :SYSTem:ERRor subsystem

Queries in the :SYSTem:LKEY subsystem

Queries in the :SYSTem:LOCK subsystem

Queries in the :SYSTem:METRics subsystem

Queries in the :SYSTem:MODule subsystem

All other commands and queries will result in the error: -203,"Command protected; Instrument locked by another I/O session"

State Saved	Not part of Save/Recall
-------------	-------------------------

Initial S/W Revision	x.16.10
----------------------	---------

Unlock Remote I/O Session (Remote Command only)

You can unlock the SCPI control of an I/O Interface and Session performing a SYSTem:LOCK:RELease command. Lock requests on an individual interface and session can be nested and each request will increase an internal lock count by 1. For every granted request, you will need to perform a release. The lock is not relinquished until the internal lock count is at 0.

Remote Command	SYSTem:LOCK:RELease
-----------------------	---------------------

Example	SYST:LOCK:REL
----------------	---------------

Notes	When the instrument is unlocked bit 0 is cleared in the Operation Instrument status register.
--------------	---

Initial S/W Revision	x.16.10
----------------------	---------

Remote I/O Session Lock Name (Remote Command only)

You can determine the I/O Interface and Session name of the currently running program with the query SYSTem:LOCK:NAME?.

Remote Command	SYSTem:LOCK:NAME?
-----------------------	-------------------

Example	SYST:LOCK:NAME?
----------------	-----------------

Notes	The information returned is a string of the format: "<I/O Interface>[/<IP address>/<Session ID>]" Where IP address and Session ID are only provided for interfaces that provide multiple sessions.
--------------	--

Single Session interfaces (GPIB, USB-488, and LAN VXI-11) only list interface name.
The Session ID is an internally generated identifier, it is not guaranteed to be consistent across instrument software versions (the identifier is free to change when the software of the instrument is updated). The absolute value of the Session ID is not significant, the identifier will be consistent for a given software version and can be relied upon for lock owner logic comparisons.

Initial S/W Revision x.16.10

Remote I/O Session Lock Owner (Remote Command only)

You can determine which I/O Interface and Session has the SCPI locked with the query `SYSTem:LOCK:OWNer?`. If no interface and session has the SCPI locked "NONE" is returned.

Remote Command `SYSTem:LOCK:OWNer?`

Example `SYST:LOCK:OWN?`

Notes The information returned is a string of the format:
 “<I/O Interface>[/<IP address>/<Session ID>]”
 Where IP address and Session ID are only provided for interfaces that provide multiple sessions.
 Single Session interfaces (GPIB, USB-488, and LAN VXI-11) only list interface name.
 The Session ID is an internally generated identifier, it is not guaranteed to be consistent across instrument software versions (the identifier is free to change when the software of the instrument is updated). The absolute value of the Session ID is not significant, the identifier will be consistent for a given software version and can be relied upon for lock owner logic comparisons.
 If no interface and session have the SCPI locked the return value is "NONE".

Initial S/W Revision x.16.10

Restore Defaults

Provides incremental initialization of the system setting groups along with supporting a comprehensive reset of the entire instrument back to a factory default state. The menu selections are the groups of system settings and when one is selected, that particular group of system settings is reset back to their default values.

NOTE In products that run multiple instances of the X-Series Application, all instances have the same factory default states for Restore Defaults.

Key Path System

Mode All

Remote Command `:SYSTem:DEFault [ALL] | ALIGn | INPut | MISC | MODes | PON`

Example `SYST:DEF`

State Saved No

Initial S/W Revision Prior to A.02.00

Restore Input/Output Defaults

Causes the group of settings and data associated with Input/Output front-panel key to be a reset to their default values. This level of Restore System Defaults does not affect any other system settings, mode settings and does not cause a mode switch. .

Confirmation is required to restore the Input/Output setting. The confirmation dialog is:

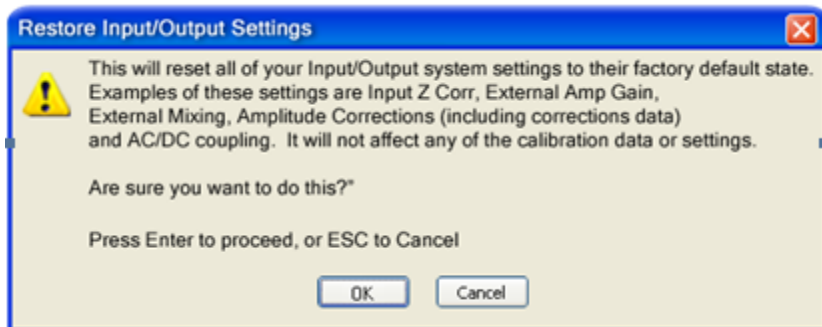

Key Path	System, Restore System Defaults
----------	---------------------------------

Example	:SYST:DEF INP
----------------	---------------

Initial S/W Revision	Prior to A.02.00
----------------------	------------------

Restore Power On Defaults

This selection causes the Power On settings to be a reset to their default value. This level of Restore System Defaults does not affect any other system settings, mode settings and does not cause a mode switch. The Power On settings and their default values are Power On Type reset to Mode and Input/Output Defaults and Power On Application reset to whatever the factory set as its default value.

Confirmation is required to restore the factory default values. The confirmation dialog is:

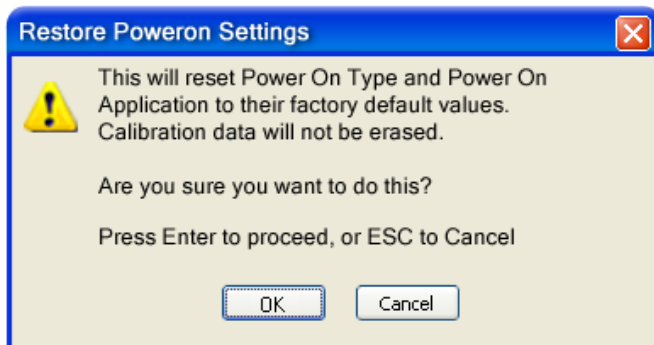

Key Path	System, Restore System Defaults
----------	---------------------------------

Example	:SYST:DEF PON
----------------	---------------

Initial S/W Revision	Prior to A.02.00
----------------------	------------------

Restore Align Defaults

This selection causes the Alignment system settings to be a reset to their default values. This does not affect any Alignment data stored in the system. This level of Restore System Defaults does not affect any other system settings, mode settings and does not cause a mode switch.

After performing this function, it may impact the auto-alignment time of the instrument until a new alignment baseline has been established.

Confirmation is required to restore the factory default values. The confirmation dialog is:

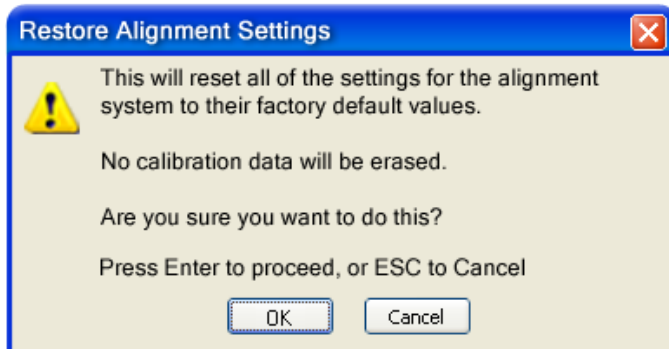

Key Path	System, Restore System Defaults
----------	---------------------------------

Example	:SYST:DEF ALIG
----------------	----------------

Initial S/W Revision	Prior to A.02.00
----------------------	------------------

Restore Misc Defaults

This selection causes miscellaneous system settings to be reset to their default values. With this reset, you lose the GPIB address and it is reset to 18, so this should be used with caution. This level of Restore System Defaults does not affect any other system settings, mode settings and does not cause a mode switch. This miscellaneous group contains the rest of the settings that have not been part of the other Restore System Defaults groups. The following table is a complete list of settings associated with this group:

Miscellaneous Setting	Default Value
Verbose SCPI	Off
The SYST:PRES:TYPE	MODE
Auto File Name Number	000
Save Type	State
State Save To	Register 1
Screen Save To	SCREEN000.png
DISP:ENABle	ON
Full Screen	Off

Miscellaneous Setting	Default Value
SCPI Telnet	ON
SCPI Socket	ON
SICL Server	ON
Softkey Language	English
System Annotation	ON
Display Theme	TDColor
System IDN Response	Factory result of *IDN?
System IDN Response selection	Factory

Confirmation is required to restore the factory default values. The confirmation dialog is:

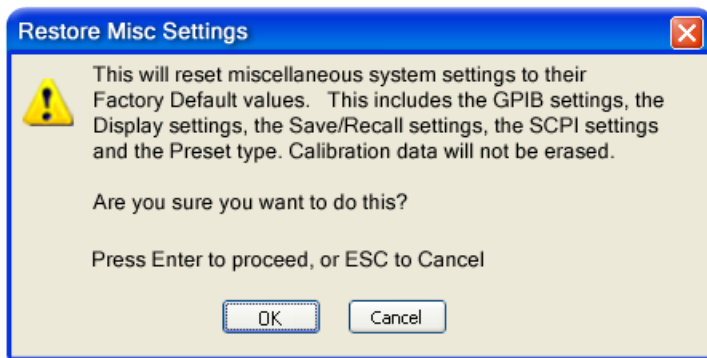

Key Path	System, Restore System Defaults
Example	:SYST:DEF MISC
Initial S/W Revision	Prior to A.02.00
Modified at S/W Revision	x.14.50

Restore Mode Defaults (All Modes)

This selection resets all of the modes in the instrument back to their default state just as a Restore Mode Defaults does and it switches the instrument to the power-on mode and causes the default measurement for the power-on mode to be active. This level of Restore System Defaults does not affect any system settings, but it does affect the state of all modes and does cause a mode switch unless the instrument was already in the power-on mode.

Confirmation is required to restore the factory default values. The confirmation dialog is:

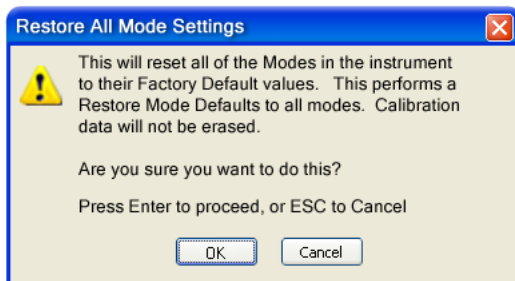

Key Path	System, Restore System Defaults
Example	:SYST:DEF MOD
Couplings	An All Mode will cause the currently running measurement to be aborted, mode switch to the power-on mode and activate the default measurement for the power-on mode.. It gets the mode to a consistent state with all of the default couplings set.
Initial S/W Revision	Prior to A.02.00

All

This performs a comprehensive reset of ALL analyzer settings to their factory default values. It resets all of the system setting groups, causes a Restore Mode Defaults for all modes in the instrument, and switches back to the power-on mode. It does not affect the User Preset file or any user saved files.

Confirmation is required to restore the factory default values. The confirmation dialog is:

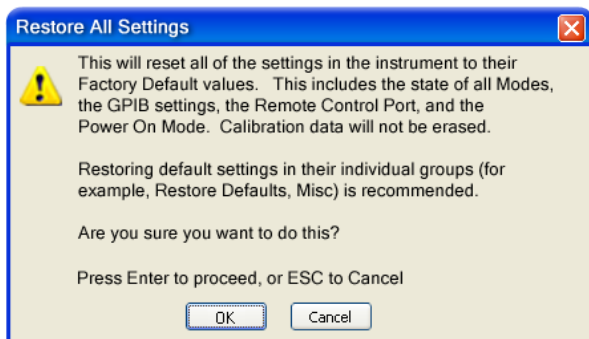

NOTE

If you are using a Keysight USB External Mixer, then you will need to perform a Refresh USB Mixer Connection after Restoring All Defaults.

Key Path	System, Restore System Defaults
Example	:SYST:DEF ALL
Notes	If using Keysight USB External Mixer, perform a Refresh USB Mixer Connection (SCPI command :MIX:BAND USB) following a Restore All Defaults.
Couplings	An All will cause the currently running measurement to be aborted and get all modes to a consistent state, so it is unnecessary to couple any settings.
Initial S/W Revision	Prior to A.02.00
Modified at S/W Revision	A.14.00

Control Panel...

Opens the Windows Control Panel. The Control Panel is used to configure certain elements of Windows that are not configured through the hardkey/softkey System menus.

NOTE This feature is not available if option SF1 is installed.

The Control Panel is a separate Windows application, so to return to the analyzer once you are in the Control Panel, you may either:

Exit the Control Panel by clicking on the red X in the upper right hand corner, with a mouse

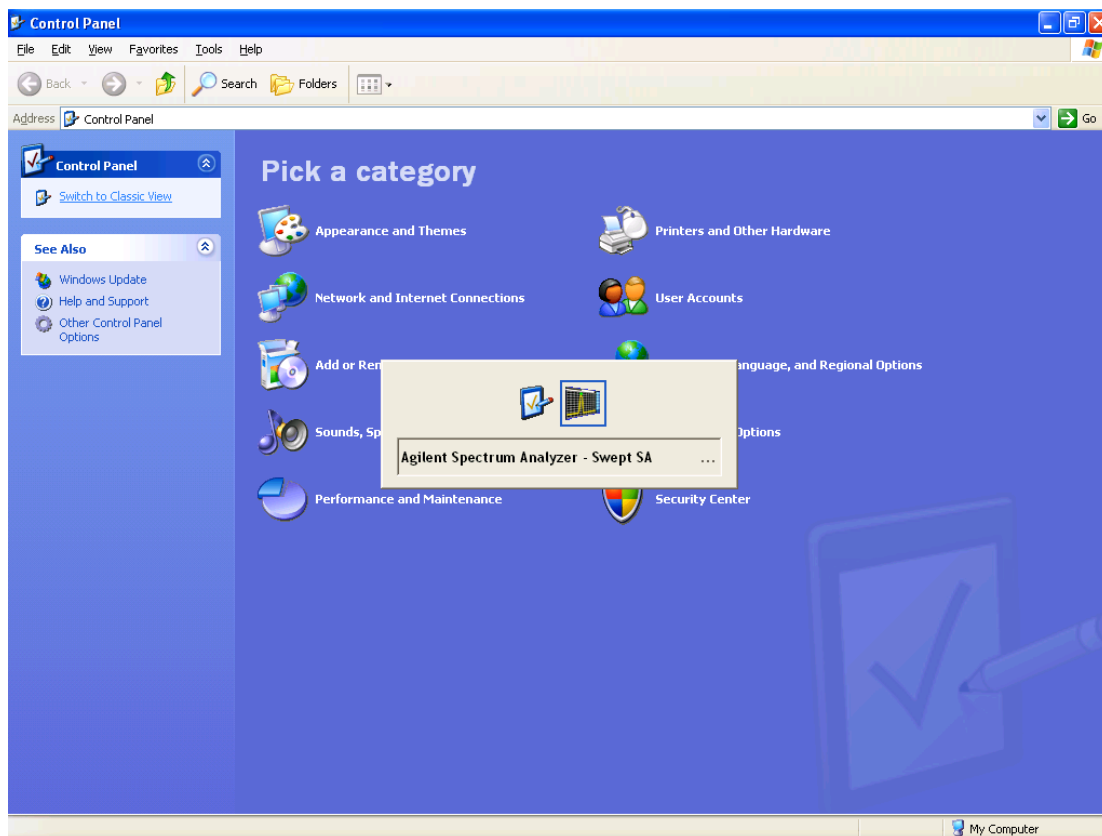

Or use Alt-Tab: press and hold the Alt key and press and release the Tab key until the Analyzer logo is showing in the window in the center of the screen, as above, then release the Alt key.

Key Path	System
Notes	No remote command for this key.
Initial S/W Revision	Prior to A.02.00

Licensing...

Opens the license explorer.

NOTE This feature is not available if option SF1 is installed.

For Help on this key, select Help in the menu bar at the top of the license explorer window.

Key Path	System
Notes	No equivalent remote command for this key.
Backwards Compatibility Notes	In ESA the SCPI command for displaying the Show Licenses screen is: :SYSTem:CONFIgure:LKEY:STATe OFF ON 0 1 :SYSTem:CONFIgure:LKEY:STATe? There are no equivalent SCPI commands in the X-Series for displaying the License Explorer.
Initial S/W Revision	Prior to A.02.00

Remote Command	:SYSTem:LKEY <"OptionInfo">, <"LicenseInfo">
Example	SYST:LKEY "N9073A-1FP", "027253AD27F83CDA5673A9BA5F427FDA5E4F25AEB1017638211AC9F60D9C639FE539735909C551DE0A91"
Notes	The <"OptionInfo"> contains the feature and the version. You must specify the feature but can omit the version. If you omit the version, the system regards it as the latest one, since the system knows which version is supported for each feature. The <"LicenseInfo"> contains the signature, the expiration date, and serial number for transport if transportable. You must specify the signature, but you can omit the other information. If you omit the expiration date, the system regards it as permanent. If you omit the serial number, the system regards it as non-transportable. As a result, this supports reverse compatibility.
Initial S/W Revision	Prior to A.02.00

Remote Command	:SYSTem:LKEY:DELeTe <"OptionInfo">,<"LicenseInfo">
Example	SYST:LKEY:DEL "N9073A-1FP", "027253AD27F83CDA5673A9BA5F427FDA5E4F25AEB1017638211AC9F60D9C639FE539735909C551DE0A91"
Notes	The <"OptionInfo"> contains the feature and the version. You must specify the feature but can omit the version. If you omit the version, the system regards it as the latest one, if more than one version is installed. The <"LicenseInfo"> contains the signature, the expiration date, and whether or not be transportable. You must specify the signature, but you can omit the other information. If you omit the expiration date, the system regards it as permanent. If you omit the transportability, the system regards it as non-transportable. As a result, this supports reverse compatibility.
Initial S/W Revision	Prior to A.02.00

Remote Command	:SYSTem:LKEY:LIST?
Notes	<p>Return Value: An <arbitrary block data> of all the installed instrument licenses. The format of each license is as follows. <Feature>,<Version>,<Signature>,<Expiration Date>,<Serial Number for Transport> Return Value Example: #3136 N9073A-1FP,1.000,B043920A51CA N9060A-2FP,1.000,4D1D1164BE64 N9020A-508,1.000,389BC042F920 N9073A-1F1,1.000,5D71E9BA814C,13-aug-2005 <arbitrary block data> is: #NMMM<data> Where: N is the number of digits that describes the number of MMM characters. For example if the data was 55 bytes, N would be 2. MMM would be the ASCII representation of the number of bytes. In the previous example, N would be 55. <data> ASCII contents of the data</p>
Initial S/W Revision	Prior to A.02.00

Remote Command	:SYSTem:LKEY? <"OptionInfo">
Example	SYST:LKEY? "N9073A-1FP"
Notes	<p>The <"OptionInfo"> contains the feature and the version. You must specify the feature but can omit the version. If you omit the version, the system regards it as the latest one. Return Value: <"LicenseInfo"> if the license is valid, null otherwise. <"LicenseInfo"> contains the signature, the expiration date, and serial number if transportable. Return Value Example: "B043920A51CA"</p>
Initial S/W Revision	Prior to A.02.00

Remote Command	:SYSTem:HID?
Notes	Return value is the host ID as a string
Initial S/W Revision	Prior to A.02.00

Security

Accesses capabilities for operating the instrument in a security controlled environment.

Key Path	System
Initial S/W Revision	A.04.00

USB

The Windows operating system can be configured to disable write access to the USB ports for users who are in a secure environment where transferring data from the instrument is prohibited. This user interface is a convenient way for the customer to disable write access to USB.

Key Path	System, Security
Mode	All
Scope	Mode Global
Remote Command	:SYSTem:SECurity:USB:WPRotect[:ENABLE] ON OFF 0 1 :SYSTem:SECurity:USB:WPRotect[:ENABLE]?
Example	:SYST:SEC:USB:WPR ON Will set USB ports to Read-only
Notes	When the USB ports are in Read-only mode then no data can be stored to USB, including the internal USB memory used for a back-up location for the calibration data.
Dependencies	This key is grayed-out unless the current user has administrator privileges.
Preset	This is unaffected by Preset or any Restore System Defaults. An Agilent Recovery will set the USB to write protect OFF
State Saved	No
Range	Read-Write Read only
Initial S/W Revision	A.04.00

Read-Write

Selection for allowing full read-write access to the USB ports.

Key Path	System, Security, USB
Example	:SYST:SEC:USB:WPR OFF Will set USB ports to Read-Write
Initial S/W Revision	A.04.00

Read only

Selection for disabling write access to the USB ports.

Key Path	System, Security, USB	
Example	:SYST:SEC:USB:WPR ON	Will set USB ports to Read only
Initial S/W Revision	A.04.00	

Diagnostics

The Diagnostics key in the System menu gives you access to basic diagnostic capabilities of the instrument.

Key Path	System
Initial S/W Revision	Prior to A.02.00

Show Hardware Statistics

Provides a display of various hardware statistics. The statistics include the following:

- High and Low temperature extremes
- Elapsed time that the instrument has been powered-on (odometer)

The display should appear listing the statistics, product number, serial number, and firmware revision.

Hardware Statistical Information		
Agilent MXA Signal Analyzer		
Product Number: N9020A		
Serial Number: US00061145		
Instrument S/W Revision: A.12.00		
Revision Date: 7/11/2012 12:11:10 PM		
Component Name	Value	
MechAtten #1 Count Total	457304	
Calibrator Switch Cycles	105953	In some CXA models this field is called "Fixed Atten"
AC/DC Switch Cycles	114240	
2 dB #1 Mechanical Atten Cycles	112655	Some CXA models omit these fields
2 dB #2 Mechanical Atten Cycles	124456	
MechAtten #2 Count Total	472265	
6 dB Mechanical Atten Cycles	115302	
10 dB Mechanical Atten Cycles	93602	
20 dB Mechanical Atten Cycles	144781	
30 dB Mechanical Atten Cycles	118580	
Low Noise Path Switch	Only shown if LNP installed 45668	
Preselector Bypass Cycles	Only shown if MPB installed 31133	
High temperature operating extreme	45.75	
Low temperature operating extreme	-23.9375	
Elapsed Time (On-Time)(hours)	134164	

The CXA models in which the AC/DC Switch field is called Fixed Atten and that omit the mechanical attenuation fields are the N9000A–503/507 models.

Modular HWs only have time and temperature information in Show Hardware Statistics.

The data will be updated only when the Show Hardware Statistics menu key is pressed, it will not be updated while the screen is displayed.

The tabular data should be directly printable.

Key Path	System, Diagnostics
Mode	All
Notes	The values displayed on the screen are only updated upon entry to the screen and not updated while the screen is being displayed.
Initial S/W Revision	Prior to A.02.00

SCPI for Show Hardware Statistics (Remote Commands Only)

Each of the hardware statistic items can be queried via SCPI.

- Error! Reference source not found.
- Error! Reference source not found.
- Error! Reference source not found.

Self test

This key gives you access to diagnostic capabilities for self tests of the instrument.

Key Path	System, Diagnostics
Initial S/W Revision	Prior to A.10.00

All Self Test

This key invokes all the self tests defined in the Diagnostics Self Test section.

Key Path	System, Diagnostics, Self Test
Remote Command	SYSTem:TEST:WCTS: [ALL]
Example	SYST:TEST:WCTS:[ALL]
Initial S/W Revision	A.12.50

FEC Self Test

This key invokes the EXT E6607C front end control self test. When operation is complete, the generated test summary information is appended to log file E:\Agilent\Instrument\FECTestLog.txt. This test summary

file can be retrieved from the instrument using the MMEM set of SCPI command, once you have the fully qualified the path and file name.

If the self test fails, the following error message will be generated:

All other models:

“-330, Self-test failed, see log file E:\Agilent\Instrument\FECTestLog.txt”

M9420A:

“-330, Self-test failed, see Front end self test log file under C:\ProgramData\Keysight\X-Series Instrument”

If the self test passes, an advisory message “FEC self-test completed successfully” is generated.

Key Path	System, Diagnostics, Self Test
Remote Command	SYSTem:TEST:WCTS:FEC
Example	SYST:TEST:WCTS:FEC
Notes	Access log with command : All other models: MMEM:DATA? "E:\ Agilent\Instrument\FECTestLog.txt" M9420A: MMEM:DATA? " C:\ProgramData\Keysight\X-Series Instrument_FECSelfTestLog_M9420A_<SerialNumber>.txt "
Initial S/W Revision	A.12.50

Show Result

This key gives you access to show results of the following self tests:

- Source self-test results
- E6607C embedded MPA or E6640A/E6650A RFIO self-test results
- E6607C FEC self-test results

Key Path	System, Diagnostics, Self Test
Initial S/W Revision	A.12.50

FEC Self Test Results

Provides a display of last FEC test results, the display should appear listing model number, serial number and test time at the top of display, and then list test date/time, test name, measured value, valid range and pass/fail of each FEC test item, the tabular data should be directly printable.

Key Path	System, Diagnostics, Self Test,Show Results
-----------------	---

Remote Command	SYSTem:TEST:WCTS:SHOW:RESult FEC
Example	SYST:TEST:WCTS:SHOW:RES FEC
Initial S/W Revision	A.12.50

The example of FEC self test result display is as follows:

FEC Self Test Results					
Produce Number: E6607C					
Serial Number: MY51380437					
Instrument S/W: 11/16/2012 2:51:19 PM					
FpgaVersionTest					
Date	Time(GMT)	Name	MeasValue	ValidRange	Result
11/23/2012	16:13:56	Analog_FPGA	16.000	>= 16.000	Pass
11/23/2012	16:13:56	Digital_FPGA	50.000	>= 46.000	Pass
11/23/2012	16:13:56	CRFS_FPGA	38.000	>= 38.000	Pass
PowerSupplyTest					
Date	Time(GMT)	Name	MeasValue	ValidRange	Result
11/23/2012	16:13:56	ABUS_+32CHK	31.904	30.900 - 32.900	Pass
11/23/2012	16:13:56	ABUS_+12CHK	12.296	10.800 - 13.200	Pass
11/23/2012	16:13:56	+10VA	9.935	9.600 - 10.200	Pass
11/23/2012	16:13:56	+5VA	4.995	4.900 - 5.100	Pass
11/23/2012	16:13:56	+3.3VA	3.299	3.200 - 3.400	Pass
11/23/2012	16:13:56	-3.3VA	-3.311	-3.400 - -3.200	Pass
11/23/2012	16:13:56	ACOM	0.00	-0.200 - 0.200	Pass
11/23/2012	16:13:56	-5VA	-5.036	-5.100 - -4.900	Pass
11/23/2012	16:13:56	-6.1VA	-5.880	-6.200 - -5.700	Pass
11/23/2012	16:13:56	-10VA	-10.116	-10.200 - -9.800	Pass
11/23/2012	16:13:56	ABUS_-2.5V_REF	-2.508	-2.520 - -2.470	Pass
11/23/2012	16:13:56	ABUS_+2.5V_REF	2.508	2.480 - 2.520	Pass
11/23/2012	16:13:56	ABUS_-10VPALC	-10.047	-10.200 - -9.800	Pass

11/23/2012	16:13:57	ABUS_DET_MOD_FLT	18.000	7.800 – 100.000	Pass
------------	----------	------------------	--------	--------------------	------

Show FEC Self Test Results contents (Remote Command Only)

A remote command is available to obtain the contents of the Show FEC Self Test Results screen (the entire contents, not just the currently displayed page).

Remote Command	SYSTem:TEST:WCTS:FEC:RESult?
Example	SYST:TEST:WCTS:FEC:RES?
Notes	The output is an IEEE Block format of the Show FEC Self Test Results contents. Each line is separated with a new-line character.
Initial S/W Revision	A.12.50

	Keysight Converged	PSA
IP Address	SYSTem:COMMunicate:LAN:ADDRes <string> SYSTem:COMMunicate:LAN:ADDRes?	:SYSTem:COMMunicate:LAN[;SELF]:IP <string> :SYSTem:COMMunicate:LAN[;SELF]:IP?
Gateway	SYSTem:COMMunicate:LAN:DGATeway <string> SYSTem:COMMunicate:LAN:DGATeway?	:SYSTem:COMMunicate:LAN[;SELF]:GATEway <string> :SYSTem:COMMunicate:LAN[;SELF]:GATEway?
Subnet Mask	SYSTem:COMMunicate:LAN:SMASk <string> SYSTem:COMMunicate:LAN:SMASk?	:SYSTem:COMMunicate:LAN[;SELF]:SUBNetmask <string> :SYSTem:COMMunicate:LAN[;SELF]:SUBNetmask?

Internet Explorer...

This key launches Microsoft Internet Explorer. A mouse and external keyboard are highly desired for using Internet Explorer. When Internet Explorer is running, close Internet Explorer to return focus to the Instrument Application (or use Alt-Tab).

Key Path	System
Mode	All
Notes	No equivalent remote command for this key.
Initial S/W Revision	A.05.01

7 Trigger Functions

Trigger

Accesses a menu of keys to control the selection of the trigger source and the setup of each of the trigger sources. The analyzer is designed to allow triggering from a number of different sources, for example, Free Run, Video, External, RF Burst, and so forth.

The TRIG:SOURCe command (below) will specify the trigger source for the currently selected input (RF or I/Q). If you change inputs, the new input remembers the trigger source it was last programmed to for the current measurement, and uses that trigger source. You can directly set the trigger source for each input using the TRIGger:RF:SOURce and TRIGger:IQ:SOURce commands (later in this section). When in External Mixing, the analyzer uses the RF trigger source.

Note the inclusion of the <measurement> parameter in the command below. Because each measurement remembers its own Trigger Source, the command must be qualified with the measurement name. Note that for the Swept SA measurement this is not the case; for backwards compatibility, no <measurement> parameter is used when setting the Trigger Source for the Swept SA measurement.

See ["Trigger Source Presets" on page 249](#)

See ["RF Trigger Source" on page 252](#)

See ["I/Q Trigger Source" on page 253](#)

See ["More Information" on page 254](#)

Key Path	Front-panel key
Remote Command	<pre>:TRIGger:<measurement>[:SEquence]:SOURce EXTernal1 EXTernal2 IMMediate LINE FRAMe RFBurst VIDeo IF ALARm LAN IQMag IDEMod QDEMod IINPut QINPut AIQMag TV INTernal</pre> <pre>:TRIGger:<measurement>[:SEquence]:SOURce?</pre> <p>where <measurement> is the measurement for which you wish to set the Source (blank for the Swept SA measurement)</p>
Example	<pre>TRIG:ACP:SOUR EXT1</pre> <p>Selects the external 1 trigger input for the ACP measurement and the selected input</p> <pre>TRIG:SOUR VID</pre> <p>Selects video triggering for the Swept SA (SANalyzer) measurement in the Spectrum Analyzer mode. For SAN, do not use the <measurement> keyword. Only send this form in the Spectrum Analyzer mode or you will get an Undefined Header error</p>
Notes	<p>Not all measurements have all the trigger sources available to them. Check the trigger source documentation for your specific measurement to see what sources are available.</p> <p>Not all trigger sources are available for each input. See the "RF Trigger Source" on page 252 and "I/Q Trigger Source" on page 253 commands for detailed information on which trigger sources are available for each input.</p> <p>Other trigger-related commands are found in the INITiate and ABORt SCPI command subsystems.</p> <p>*OPC should be used after requesting data. This will hold off any subsequent changes to the selected trigger source, until after the sweep is completed and the data is returned.</p> <p>Available ranges and presets can vary from mode to mode.</p>
Dependencies	<p>In some models, there is no second External input. In these models, the External 2 key is blanked and</p>

	the EXternal2 parameter will generate a "Hardware missing; Not available for this model number" message. INTernal is only available for M9420A.
Preset	See table below
Status Bits/OPC dependencies	The Status Operation Register bit 5 "Waiting for Trigger" is set at the same time as the Sweeping or Measuring bit is set. It is cleared when the trigger actually occurs (that is, after the trigger event occurs and all the applicable trigger criteria have been met). A corresponding pop-up message ("Waiting for trigger") is generated if no trigger signal appears after approximately 2 sec. This message goes away when a trigger signal appears.
Backwards Compatibility SCPI	:TRIGger[:SEquence]:SOURce EXTernal For backward compatibility, the parameter EXTernal is mapped to EXTernal1
Backwards Compatibility SCPI	[:SENSe]:<measurement>:TRIGger:SOURce This backwards compatibility alias command is provided for ESA/PSA compatibility This backwards compatibility command does not apply to the Swept SA measurement, for that just use :TRIGger:SOURce This backwards compatibility command does not apply to the monitor spectrum, log plot and spot frequency measurements
Backwards Compatibility SCPI	[:SENSe]:<measurement>:TRIGger:SOURce IF In earlier instruments, the parameter IF was used by apps for the video trigger, so using the IF parameter selects VIDeo triggering. Sending IF in the command causes VID to be returned to a query.
Backwards Compatibility SCPI	[:SENSe]:ACPr:TRIGger:SOURce This backwards Compatibility SCPI command is provided to support the same functionality as [:SENSe]:ACPr:TRIGger:SOURce (PSA W-CDMA, PSA cdma2000 and PSA 1xEVDO) due to the fact that the ACPr node conflicts with the ACPower node.
Initial S/W Revision	Prior to A.02.00
Modified at S/W Revision	A.03.00

Trigger Source Presets

Here are the Trigger Source Presets for the various measurements:

Meas	Mode	Preset for RF	Preset for IQ	Notes
Swept SA	SA	IMM	IQ not supported	
CHP	SA, WCDMA, C2K, WIMAX OFDMA, 1xEVDO, DVB-T/H, DTMB, LTE, LTETDD, CMMB, ISDB-T, Digital Cable TV, MSR	IMM	IQ not supported	

OBW	SA, WCDMA, C2K, WIMAX OFDMA, TD-SCDMA, 1xEVDO, LTE, LTETDD, CMMB, ISDB-T, MSR	1xEVDO: EXT1 others: IMM	IQ not supported	For 1xEVDO mode, the trigger source is coupled with the gate state, as well as the gate source. When the trigger source changes to RFBurst, External1 or External2, the gate state is set to on, and the gate source is set identically with the trigger source. When the trigger source changes to IMMEDIATE, VIDEO, LINE, FRAME or IF, the gate state is set to off.
CCDF	SA, WCDMA, C2K, WIMAXOFDMA, TD-SCDMA, 1xEV-DO, DVB-T/H, DTMB, LTE, LTETDD, CMMB, ISDB-T, Digital Cable TV, MSR	WIMAXOFDMA: RFBurst LTETDD: BTS: External 1 MS: Periodic Timer TD-SCDMA and 1xEV-DO: BTS: External 1 MS: RFBurst SA, WCDMA, C2K, LTE, CMMB, ISDB-T, DVB-T/H, DTMB, Digital Cable TV, MSR: IMMEDIATE	TD-SCDMA and 1xEV-DO: BTS: External 1 MS: IQMag LTETDD: BTS: External 1 MS: Periodic Timer Others: IMM	For TD-SCDMA: Trigger source is coupled with radio device. When radio device changes to BTS, trigger source will be changed to EXTERNAL1. When radio device changes to MS, trigger source will be set as RFBurst for RF or IQ Mag for BBIQ. When TriggerSource is RFBurst or IQ Mag, Measure Interval is grayed out.
ACP	SA, WCDMA, C2K, WIMAX OFDMA, TD-SCDMA, 1xEVDO, DVB-T/H, DTMB, LTE, LTETDD, CMMB, ISDB-T, Digital Cable TV, MSR	IMM	IQ not supported	
Tx Power	SA, GSM, TD-SCDMA	SA, GSM: RFBurst TD-SCDMA: EXTERNAL	IMM	TD-SCDMA doesn't support the Line and Periodic Timer parameters. When the mode is TD-SCDMA, if the Radio Device is switched to BTS, the value will be changed to External 1 and if the Radio device is switched to MS, the value will be changed to RFBurst
SPUR	SA, WCDMA, C2K, WIMAX OFDMA, TD-SCDMA, 1xEV-DO, DVB-T/H, LTE, LTETDD, MSR	IMM	IQ not supported	
SEM	SA, WCDMA, C2K,	1xEVDO(BTS): EXTERNAL1	IQ not supported	

	WIMAX OFDMA, TD-SCDMA, 1xEVDO, DVB- T/H, DTMB, LTE, LTETDD, CMMB, ISDB-T, Digital Cable TV, MSR	All others: IMMEDIATE		
CDP	WCDMA	IMM	IMM	
RHO	WCDMA	IMM	IMM	
PCON	WCDMA	IMM	IMM	
QPSK	WCDMA, C2K, 1xEVDO	All except CDMA1xEVDO: IMMEDIATE CDMA1xEVDO: EXT1	IMM	
MON	All except SA and BASIC	IMM	IQ not supported	
WAV		LTETDD: BTS: External 1 MS: Periodic Timer GSM/EDGE: RFBurst All others: IMMEDIATE	LTETDD: BTS: External 1 MS: Periodic Timer GSM/EDGE: IQMag All others: IMMEDIATE	
PVT	WIMAXOFDMA	RFB	IMM	
EVM	WIMAXOFDMA, DVB-T/H, DTMB, LTE, LTETDD, CMMB, ISDB-T, Digital Cable TV	All but CMMB: IMM CMMB: Periodic Timer	All but CMMB: IMM CMMB: External 1	LTE, LTETDD supports Free Run, Video and External 1 only.
SPEC	BASIC	IMM	IMM	
LOG Plot	PN	IMM	IQ not supported	
Spot Freq	PN	IMM	IQ not supported	
GMSK PVT	EDGE/GSM	RFB	IMM	
GMSK PFER	EDGE/GSM	RFB	IQMag	
GMSK ORFS	EDGE/GSM	RF Burst	IQ not supported	

Example	<p>TRIG:ACP:RF:SOUR EXT1</p> <p>Selects the external 1 trigger input for the ACP measurement and the RF input</p> <p>TRIG:RF:SOUR VID</p> <p>Selects video triggering for the SANalyzer measurement and the RF input. For SAN, do not use the <measurement> keyword.</p>
Notes	<p>Not all measurements have all the trigger sources available to them. Check the trigger source documentation for your specific measurement to see what sources are available.</p> <p>Not all trigger sources are available for each input. For the RF Trigger Source, the following trigger sources are available:</p> <ul style="list-style-type: none"> –IMMediate - free run triggering –VIDeo - triggers on the video signal level –LINE - triggers on the power line signal –EXTernal1 (or EXTernal) - triggers on an externally connected trigger source marked "Trigger 1 In" on the rear panel –EXTernal2 - triggers on an externally connected trigger source marked "Trigger 2 In" on the front panel. In some models, there is no second External input. In these models, the External 2 key is blanked and the EXTernal2 parameter will generate a "Hardware missing; Not available for this model number" message –RFBurst - triggers on the bursted frame –FRAMe - triggers on the periodic timer –IF (video) - same as video, for backwards compatibility only <p>M9420A:</p> <ul style="list-style-type: none"> –INTernal - triggers on the internal source signal <p>*OPC should be used after requesting data. This will hold off any subsequent changes to the selected trigger source, until after the sweep is completed and the data is returned.</p> <p>Available ranges, and presets can vary from mode to mode.</p>
Status Bits/OPC dependencies	<p>The Status Operation Register bit 5 "Waiting for Trigger" is set at the same time as the Sweeping or Measuring bit is set. It is cleared when the trigger actually occurs (that is, after the trigger event occurs and all the applicable trigger criteria have been met). A corresponding pop-up message ("Waiting for trigger") is generated if no trigger signal appears after approximately 2 sec. This message goes away when a trigger signal appears.</p>
Initial S/W Revision	Prior to A.02.00

I/Q Trigger Source

This command selects the trigger to be used for the specified measurement when I/Q (which requires option BBA) is the selected input. The I/Q trigger source can be queried and changed even while another input is selected, but it is inactive until I/Q becomes the selected input.

Remote Command	<pre>:TRIGger:<measurement>[:SEquence]:IQ:SOURce EXTernal1 EXTernal2 IMMediate IQMag IDEMod QDEMod IINPut QINPut AIQMag :TRIGger:<measurement>[:SEquence]:IQ:SOURce?</pre>
-----------------------	---

Example	TRIG:WAVeform:SOUR IQM
----------------	------------------------

	Selects I/Q magnitude triggering for the IQ Waveform measurement and the I/Q input
Notes	<p>Not all measurements have all the trigger sources available to them. Check the trigger source documentation for your specific measurement to see what sources are available.</p> <p>Not all trigger sources are available for each input. For the I/Q Trigger Source, the following trigger sources are available:</p> <ul style="list-style-type: none"> –IMMediate - free run triggering –EXTernal1 (or EXTernal) - triggers on an externally connected trigger source on the rear panel –EXTernal2 - triggers on an externally connected trigger source on the front panel –IQMag - triggers on the magnitude of the I/Q signal –IDEMod - triggers on the I/Q signal's demodulated I voltage –QDEMod - triggers on the I/Q signal's demodulated Q voltage –IINPut - triggers on the I channel's ADC voltage –QINPut - triggers on the Q channel's ADC voltage –AIQMag - triggers on the magnitude of the auxiliary receiver channel I/Q signal <p>*OPC should be used after requesting data. This will hold off any subsequent changes to the selected trigger source, until after the sweep is completed and the data is returned.</p> <p>Available ranges, and from mode to mode presets can vary</p>
Status Bits/OPC dependencies	The Status Operation Register bit 5 "Waiting for Trigger" is set at the same time as the Sweeping or Measuring bit is set. It is cleared when the trigger actually occurs (that is, after the trigger event occurs and all the applicable trigger criteria have been met). A corresponding pop-up message ("Waiting for trigger") is generated if no trigger signal appears after approximately 2 sec. This message goes away when a trigger signal appears.
Initial S/W Revision	Prior to A.02.00

More Information

The trigger menus let you select the trigger source and trigger settings for a sweep or measurement. In triggered operation (basically, any trigger source other than Free Run), the analyzer will begin a sweep or measurement only with the selected trigger conditions are met, generally when your trigger source signal meets the specified trigger level and polarity requirements. (In FFT measurements, the trigger controls when the data acquisition begins for FFT conversion.)

For each of the trigger sources, you may define a set of operational parameters or settings which will be applied when that source is selected as the current trigger source. Examples of these settings are Trigger Level, Trigger Delay, and Trigger Slope. You may apply different settings for each source; so, for example, you could have a Trigger Level of 1v for External 1 trigger and –10 dBm for Video trigger.

Once you have established the settings for a given trigger source, they generally will remain unchanged for that trigger source as you go from measurement to measurement within a Mode (although the settings do change as you go from Mode to Mode). Furthermore, the trigger settings within a Mode are the same for the **Trigger** menu, the **Gate Source** menu, and the **Sync Source** menu that is part of the **Periodic Timer Trigger Setup** menu. That is, if Ext1 trigger level is set to 1v in the **Trigger** menu, it will appear as 1v in both the **Gate Source** and the **Sync Source** menus. For these reasons the trigger settings commands are not qualified with the measurement name, the way the trigger source commands are.

The settings setup menu can be accessed by pressing the key for the current trigger source a second time. For example, one press of Video selects the Video trigger as the source. The Video key becomes highlighted and the hollow arrow on the key turns black. Now a second press of the key takes you into the Video Trigger Setup menu.

Trigger Setup Parameters:

The following examples show trigger setup parameters using an external trigger source.

Example 1 illustrates the trigger conditions with negative slope and no trigger occurs during trigger Holdoff time.

Example 2 illustrates the trigger conditions with positive slope, trigger delay, and auto trigger time.

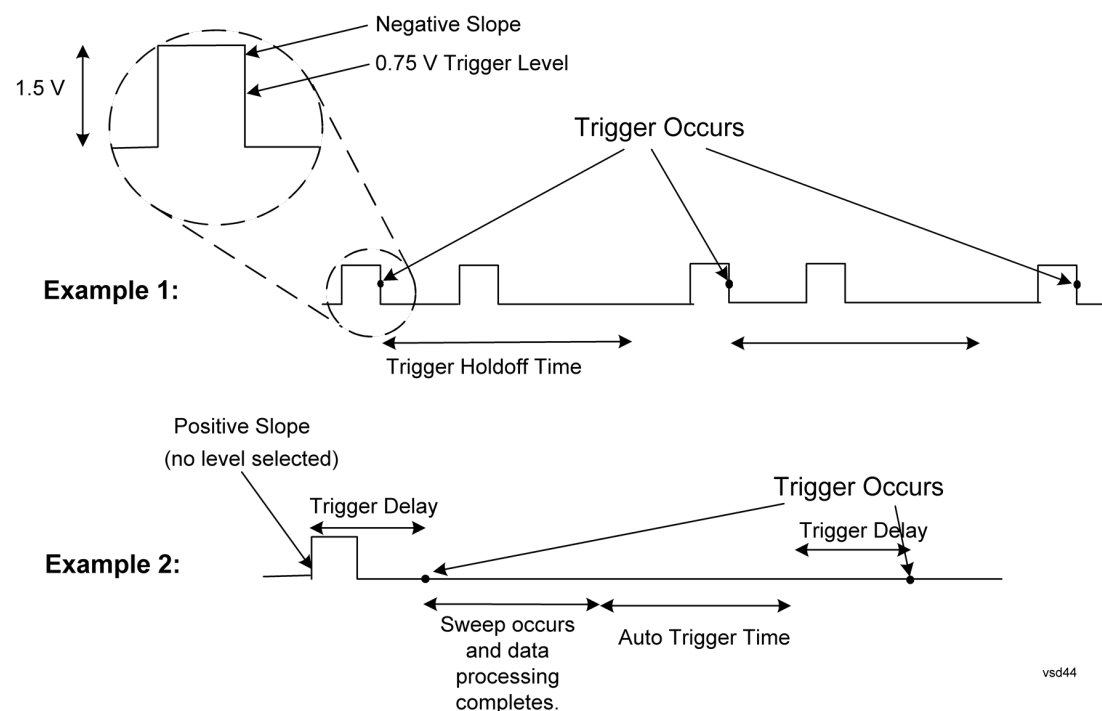

Free Run

Pressing this key, when it is not selected, selects free-run triggering. Free run triggering occurs immediately after the sweep/measurement is initiated.

Key Path	Trigger
Example	TRIG:SOUR IMM Swept SA measurement TRIG:<meas>:SOUR IMM Measurements other than Swept SA
State Saved	Saved in instrument state
Status Bits/OPC dependencies	The Status Operation Register bit 5 "Waiting for Trigger" is set at the same time as the Sweeping or Measuring bit is set. It is cleared when the trigger actually occurs (that is, after the trigger event occurs and all the applicable trigger criteria have been met). A corresponding pop-up message ("Waiting for trigger") is generated if no trigger signal appears after approximately 2 sec. This

	message goes away when a trigger signal appears.
Initial S/W Revision	Prior to A.02.00

Video (IF Envelope)

Pressing this key, when it is not selected, selects the video signal as the trigger. The Video trigger condition is met when the video signal (the filtered and detected version of the input signal, including both RBW and VBW filtering) crosses the video trigger level.

NOTE

When the detector selected for all active traces is the average detector, the video signal for triggering does not include any VBW filtering.

The video trigger level is shown as a labeled line on the display. The line is displayed as long as video is the selected trigger source.

Pressing this key, when it is already selected, accesses the video trigger setup functions.

Key Path	Trigger
Example	TRIG:SOUR VID Swept SA measurement TRIG:<meas>:SOUR VID Measurements other than Swept SA
Notes	Log Plot and Spot Frequency measurements do not support Video Trigger
Dependencies	Video trigger is allowed in average detector mode.
State Saved	Saved in instrument state
Status Bits/OPC dependencies	The Status Operation Register bit 5 "Waiting for Trigger" is set at the same time as the Sweeping or Measuring bit is set. It is cleared when the trigger actually occurs (that is, after the trigger event occurs and all the applicable trigger criteria have been met). A corresponding pop-up message ("Waiting for trigger") is generated if no trigger signal appears after approximately 2 sec. This message goes away when a trigger signal appears.
Backwards Compatibility Notes	In the past, the Average detector was not available when Video triggering was on, and consequently, functions that set the detector to average (such as Marker Noise or Band/Intvl Power) were not available when the video trigger was on. Similarly, Video triggering was not available when the detector was Average. In the X-Series, these restrictions are removed.
Initial S/W Revision	Prior to A.02.00

Trigger Level

Sets a level for the video signal trigger. When the video signal crosses this level, with the chosen slope, the trigger occurs. This level is displayed with a horizontal line only if **Video** is the selected trigger source.

Key Path	Trigger, Video
Remote Command	:TRIGger[:SEquence]:VIDeo:LEVel <amp1> :TRIGger[:SEquence]:VIDeo:LEVel?

Example	TRIG:VID:LEV -40 dBm
Notes	<p>When sweep type = FFT, the video trigger uses the amplitude envelope in a bandwidth wider than the FFT width as a trigger source. This might often be useful, but does not have the same relationship between the displayed trace and the trigger level as in swept triggering.</p> <p>Amplitude Corrections are not taken into account by the Video Trig Level. For example, if you have given yourself effective gain with an amplitude correction factor, the Video Trigger will not fire until you have dropped the trigger line that far below the displayed signal level, rather than simply dropping it down to the displayed signal level.</p> <p>Note that other corrections, specifically External Gain and Ref Level Offset, modify the actual trace data as it is taken and therefore ARE taken into account by Trig Level.</p>
Couplings	This same level is used for the Video trigger source in the Trigger menu and for the Video selection in the Gate Source menu.
Preset	Set the Video Trigger Level -25 dBm on Preset. When the Video Trigger Level becomes the active function, if the value is off screen, set it to either the top or bottom of screen, depending on which direction off screen it was.
State Saved	Saved in instrument state
Min	-170 dBm
Max	+30 dBm
Default Unit	Depends on the current selected Y axis unit
Backwards Compatibility SCPI	:TRIGger[:SEquence]:IF:LEVel
	:TRIGger[:SEquence]:IF:LEVel?
Backwards Compatibility Notes	This alias is provided for backward compatibility with VSA/PSA comms apps.
Initial S/W Revision	Prior to A.02.00

Trig Slope

Controls the trigger polarity. It is set positive to trigger on a rising edge and negative to trigger on a falling edge.

Key Path	Trigger, Video
Remote Command	:TRIGger[:SEquence]:VIDeo:SLOPe POSitive NEGative :TRIGger[:SEquence]:VIDeo:SLOPe?
Example	TRIG:VID:SLOP NEG
Preset	POSitive
State Saved	Saved in instrument state
Backwards Compatibility SCPI	:TRIGger[:SEquence]:IF:SLOPe NEGative POSitive :TRIGger[:SEquence]:IF:SLOPe?
	For backward compatibility with VSA/PSA comms apps
Backwards Compatibility	The legacy :TRIGger[:SEquence]:SLOPe command affects the slopes for the VID, LINE, EXT1, EXT2,

Notes	and RFB triggers.
Initial S/W Revision	Prior to A.02.00
Remote Command	:TRIGger[:SEquence]:SLOPe POSitive NEGative :TRIGger[:SEquence]:SLOPe?
Example	TRIG:SLOP NEG
Preset	POSitive
State Saved	Saved in instrument state
Backwards Compatibility Notes	In ESA/PSA, the Trigger Slope was global to all triggers. In the X-Series, the slope can be set individually for each Trigger Source. For backward compatibility, the global SLOPe command updates all instances of trigger slope (VID, LINE, EXT1, EXT2, TV, RFB). The query returns the trigger slope setting of the currently selected trigger source.
Initial S/W Revision	Prior to A.02.00

Trig Delay

Controls a time delay during that the analyzer will wait to begin a sweep after meeting the trigger criteria. You can use negative delay to pre-trigger the instrument in the time domain or FFT, but not in swept spans.

Key Path	Trigger, Video
Remote Command	:TRIGger[:SEquence]:VIDeo:DELAy <time> :TRIGger[:SEquence]:VIDeo:DELAy? :TRIGger[:SEquence]:VIDeo:DELAy:STATe OFF ON 0 1 :TRIGger[:SEquence]:VIDeo:DELAy:STATe?
Example	TRIG:VID:DEL:STAT ON TRIG:VID:DEL 100 ms
Notes	Video trigger delay may be set to negative values, in time domain, FFT and even swept. It makes intuitive sense in time domain and works well in FFT mode where the bandwidth of the filter before the video trigger is about 1.25 span. In swept spans, negative settings of Trig Delay are treated as a zero setting within the internal hardware and the advisory message "Neg. Trig Delay unavailable in Swept Mode, zero delay used." is generated when such a delay is set.
Preset	Off, 1 us
State Saved	Saved in instrument state
Min	-150 ms
Max	+500 ms
Default Unit	s
Backwards Compatibility Notes	! For backward compatibility with VSA/PSA comms apps :TRIGger[:SEquence]:IF:DELAy :TRIGger[:SEquence]:DELAy

	The legacy :TRIGger[:SEQuence]:DELay command affects the delay for the VID, LINE, EXT1, EXT2, and RFB triggers.
Initial S/W Revision	Prior to A.02.00
Remote Command	:TRIGger[:SEQuence]:DELay <time> :TRIGger[:SEQuence]:DELay? :TRIGger[:SEQuence]:DELay:STATe OFF ON 0 1 :TRIGger[:SEQuence]:DELay:STATe?
Example	TRIG:DEL 1 ms
Preset	1 us
State Saved	Saved in instrument state
Backwards Compatibility Notes	In ESA/PSA, the Trigger Delay was global to all triggers. In the X-Series, the delay can be set individually for each Trigger Source. For backward compatibility, the global DELay command updates all instances of trigger slope (VID, LINE, EXT1, EXT2) except TV and RFBurst. The query returns the trigger delay setting of the currently selected trigger source.
Initial S/W Revision	Prior to A.02.00
Remote Command	:TRIGger[:SEQuence]:OFFSet <time> :TRIGger[:SEQuence]:OFFSet? :TRIGger[:SEQuence]:OFFSet:STATe OFF ON 0 1 :TRIGger[:SEQuence]:OFFSet:STATe?
Example	TRIG:OFFS ON TRIG:OFFS -100 ms
Notes	These are ESA commands for trigger offset that allowed you to use a positive or negative delay when in zero span and in a Res BW ≥ 1 kHz. For ESA compatibility, X-series analyzers keep track of this offset and adds it to the Trigger Delay for VIDEo, LINE, EXTernal1 or EXTernal2 whenever the value is sent to the hardware, if in Zero Span and RBW ≥ 1 kHz.
Preset	Off, 0 s
State Saved	Saved in instrument state
Min	-11 s
Max	+11 s
Initial S/W Revision	Prior to A.02.00

External 1

Pressing this key, when it is not selected, selects an external input signal as the trigger. A new sweep/measurement will start when the external trigger condition is met using the external 1 input connector on the rear panel.

Pressing this key, when it is already selected, accesses the external 1 trigger setup menu.

Key Path	Trigger
Example	TRIG:SOUR EXT1 Swept SA measurement TRIG:<meas>:SOUR EXT1 Measurements other than Swept SA
Dependencies	Grayed out if in use by Point Trigger in the Source Setup menu. Forced to Free Run if already selected and Point Trigger is set to External 1.
State Saved	Saved in instrument state
Status Bits/OPC dependencies	The Status Operation Register bit 5 "Waiting for Trigger" is set at the same time as the Sweeping or Measuring bit is set. It is cleared when the trigger actually occurs (that is, after the trigger event occurs and all the applicable trigger criteria have been met). A corresponding pop-up message ("Waiting for trigger") is generated if no trigger signal appears after approximately 2 sec. This message goes away when a trigger signal appears.
Initial S/W Revision	Prior to A.02.00

Trigger Level

Sets the value where the external 1 trigger input will trigger a new sweep/measurement.

Key Path	Trigger, External 1
Remote Command	:TRIGger[:SEquence]:EXTernal1:LEVel <level> :TRIGger[:SEquence]:EXTernal1:LEVel?
Example	TRIG:EXT1:LEV 0.4 V
Couplings	This same level is used for the Ext1 trigger source in the Trigger menu, for the Ext1 selection in the Periodic Timer sync source (in the Trigger menu and in the Gate Source menu), and also for the Ext1 selection in the Gate Source menu.
Preset	1.2 V
State Saved	Saved in instrument state
Min	-3.5V
Max	3.5V
Default Unit	V
Backwards Compatibility SCPI	:TRIGger[:SEquence]:EXTernal:LEVel For backward compatibility, the parameter EXTernal is mapped to EXTernal1
Backwards Compatibility SCPI	:TRIGger[:SEquence]:FRAME:EXTernal1:LEVel
Initial S/W Revision	Prior to A.02.00

Trig Slope

Controls the trigger polarity. It is set positive to trigger on a rising edge and negative to trigger on a falling edge.

Key Path	Trigger, External 1
Remote Command	:TRIGger[:SEquence]:EXTernal1:SLOPe POSitive NEGative :TRIGger[:SEquence]:EXTernal1:SLOPe?
Example	TRIG:EXT1:SLOP NEG
Couplings	This same slope is used in the Ext1 selection for the trigger source in the Trigger menu and for the period timer sync source (in the Trigger menu and in the Gate Source menu).
Preset	POSitive
State Saved	Saved in instrument state
Backwards Compatibility SCPI	:TRIGger[:SEquence]:EXTernal:SLOPe For backward compatibility, the parameter EXTernal is mapped to EXTernal1
Backwards Compatibility SCPI	:TRIGger[:SEquence]:FRAMe:EXTernal1:SLOPe
Backwards Compatibility Notes	The legacy :TRIGger[:SEquence]:SLOPe command affects the slopes for the VID, LINE, EXT1, EXT2, and RFB triggers.
Initial S/W Revision	Prior to A.02.00

Trig Delay

Controls a time delay during which the analyzer will wait to begin a sweep after meeting the trigger criteria. You can use negative delay to pre-trigger the instrument in time domain or FFT, but not in swept spans.

Key Path	Trigger, External 1
Remote Command	:TRIGger[:SEquence]:EXTernal1:DELay <time> :TRIGger[:SEquence]:EXTernal1:DELay? :TRIGger[:SEquence]:EXTernal1:DELay:STATE OFF ON 0 1 :TRIGger[:SEquence]:EXTernal1:DELay:STATE?
Example	TRIG:EXT1:DEL:STAT ON TRIG:EXT1:DEL 100 ms
Notes	Video trigger delay may be set to negative values, in time domain, FFT and even swept. It makes intuitive sense in time domain and works well in FFT mode where the bandwidth of the filter before the video trigger is about 1.25 span. In swept spans, negative settings of Trig Delay are treated as a zero setting within the internal hardware and the advisory message "Neg. Trig Delay unavailable in Swept Mode, zero delay used." is generated when such a delay is set.
Preset	Off, 1.000 us
State Saved	Saved in instrument state
Min	-150 ms

Max	+500 ms
Default Unit	s
Backwards Compatibility SCPI	:TRIGger[:SEquence]:EXTernal:DELay For backward compatibility, the parameter EXTernal is mapped to EXTernal1
Backwards Compatibility Notes	The legacy :TRIGger[:SEquence]:DELay command affects the delay for the VID, LINE, EXT1, EXT2, and RFB triggers. The legacy :TRIGger[:SEquence]:OFFSet command is supported for the VIDeo, LINE, EXT1, and EXT2 triggers.
Initial S/W Revision	Prior to A.02.00

Zero Span Delay Comp On/Off

In zero span, there is a natural delay in the signal path, which comes from the RBW filter. This is usually desirable, as it allows you to trigger on events and also see those events, because the signal is delayed from the trigger event. However, in some cases it is desirable to eliminate this delay, so that trigger events line up exactly with the zero time point in zero span. You can use the Zero Span Delay Comp On/Off feature to enable or disable zero span delay compensation.

Key Path	Trigger, External 1
Remote Command	:TRIGger[:SEquence]:EXTernal1:DELay:COMPensation OFF ON 0 1 :TRIGger[:SEquence]:EXTernal1:DELay:COMPensation?
Example	TRIG:EXT1:DEL:COMP ON
Dependencies	No effect except in zero-span, but not locked out in nonzero spans. Blanked in modes that do not support zero-span measurements. If the SCPI command is sent when the key is blanked, an error is returned: -221, "Settings conflict; Feature not supported for this measurement" In analyzers shipping N9060A, this feature requires N9060A-7FP.
Preset	OFF
State Saved	Saved in instrument state
Initial S/W Revision	A.11.00

External 2

Pressing this key, when it is not selected, selects an external input signal as the trigger. A new sweep/measurement will start when the external trigger condition is met using the external 2 input connector. The external trigger 2 input connector is on the rear panel.

Pressing this key, when it is already selected, accesses the external 2 trigger setup menu.

Key Path	Trigger
Example	TRIG:SOUR EXT2 Swept SA measurement TRIG:<meas>:SOUR EXT2 Measurements other than Swept SA

Dependencies	In some models, there is no second External input. In these models, the External 2 key is blanked and the EXTernal2 parameter will generate a "Hardware missing; Not available for this model number" message. Grayed out if in use by Point Trigger in the Source Setup menu. Forced to Free Run if already selected and Point Trigger is set to External 2.
State Saved	Saved in instrument state
Status Bits/OPC dependencies	The Status Operation Register bit 5 "Waiting for Trigger" is set at the same time as the Sweeping or Measuring bit is set. It is cleared when the trigger actually occurs (that is, after the trigger event occurs and all the applicable trigger criteria have been met). A corresponding pop-up message ("Waiting for trigger") is generated if no trigger signal appears after approximately 2 sec. This message goes away when a trigger signal appears.
Initial S/W Revision	Prior to A.02.00
Modified at S/W Revision	A.03.00

Trigger Level

Sets the value where the external 2 trigger input will trigger a new sweep/measurement.

Key Path	Trigger, External 2
Remote Command	:TRIGger[:SEquence]:EXTernal2:LEVel :TRIGger[:SEquence]:EXTernal2:LEVel?
Example	TRIG:EXT2:LEV 1.1 V
Couplings	This same level is used for the Ext2 trigger source in the Trigger menu, for the Ext2 selection in the Periodic Timer sync source (in the Trigger menu and in the Gate Source menu), and also for the Ext2 selection in the Gate Source menu.
Preset	1.2 V
State Saved	Saved in instrument state
Min	-3.5V
Max	3.5V
Default Unit	V
Backwards Compatibility SCPI	:TRIGger[:SEquence]:FRAMe:EXTernal2:LEVel
Initial S/W Revision	Prior to A.02.00

Trig Slope

Controls the trigger polarity. It is set positive to trigger on a rising edge and negative to trigger on a falling edge.

Key Path	Trigger, External 2
Remote Command	:TRIGger[:SEquence]:EXTErnal2:SLOPe POSitive NEGative :TRIGger[:SEquence]:EXTErnal2:SLOPe?
Example	TRIG:EXT2:SLOP NEG
Couplings	This same slope is used in the Ext2 selection for the trigger source in the Trigger menu and for the period timer sync source (in the Trigger menu and in the Gate Source menu).
Preset	POSitive
State Saved	Saved in instrument state
Backwards Compatibility SCPI	:TRIGger[:SEquence]:FRAME:EXTErnal2:SLOPe
Backwards Compatibility Notes	The legacy :TRIGger[:SEquence]:SLOPe command affects the slopes for the VID, LINE, EXT1, EXT2, and RFB triggers.
Initial S/W Revision	Prior to A.02.00

Trig Delay

Controls a time delay during which the analyzer will wait to begin a sweep after meeting the trigger criteria. You can use negative delay to pre-trigger the instrument in time domain or FFT, but not in swept spans.

Key Path	Trigger, External 2
Remote Command	:TRIGger[:SEquence]:EXTErnal2:DElAY <time> :TRIGger[:SEquence]:EXTErnal2:DElAY? :TRIGger[:SEquence]:EXTErnal2:DElAY:STATe OFF ON 0 1 :TRIGger[:SEquence]:EXTErnal2:DElAY:STATe?
Example	TRIG:EXT2:DEL:STAT ON TRIG:EXT2:DEL 100 ms
Notes	Video trigger delay may be set to negative values, in time domain, FFT and even swept. It makes intuitive sense in time domain and works well in FFT mode where the bandwidth of the filter before the video trigger is about 1.25 span. In swept spans, negative settings of Trig Delay are treated as a zero setting within the internal hardware and the advisory message "Neg. Trig Delay unavailable in Swept Mode, zero delay used." is generated when such a delay is set.
Preset	Off, 1.000 us
State Saved	Saved in instrument state
Min	-150 ms
Max	500 ms
Default Unit	s
Backwards Compatibility Notes	The legacy :TRIGger[:SEquence]:DElAY command affects the delay for the VID, LINE, EXT1, EXT2, and RFB triggers. The legacy :TRIGger[:SEquence]:OFFSet command is supported for the VIDEo, LINE, EXT1, and EXT2 triggers.

Initial S/W Revision	Prior to A.02.00
----------------------	------------------

Zero Span Delay Comp On/Off

In zero span, there is a natural delay in the signal path, which comes from the RBW filter. This is usually desirable, as it allows you to trigger on events and also see those events, because the signal is delayed from the trigger event. However, in some cases it is desirable to eliminate this delay, so that trigger events line up exactly with the zero time point in zero span. You can use the Zero Span Delay Comp On/Off feature to enable or disable zero span delay compensation.

Key Path	Trigger, External 2
Remote Command	:TRIGger[:SEquence]:EXTernal2:DElay:COMPensation OFF ON 0 1 :TRIGger[:SEquence]:EXTernal2:DElay:COMPensation?
Example	TRIG:EXT2:DEL:COMP ON
Dependencies	No effect except in zero-span, but not locked out in nonzero spans. Blanked in modes that do not support zero-span measurements. If the SCPI command is sent when the key is blanked, an error is returned: -221, "Settings conflict; Feature not supported for this measurement" In analyzers shipping N9060A, this feature requires N9060A-7FP.
Preset	OFF
State Saved	Saved in instrument state
Initial S/W Revision	A.11.00

RF Burst

Pressing this key, when it is not selected, selects the RF Burst as the trigger. A new sweep/measurement will start when an RF burst envelope signal is identified from the signal at the RF Input connector. Pressing this key, when it is already selected, accesses the RF Burst trigger setup menu.

In some models, a variety of burst trigger circuitry is available, resulting in various available burst trigger bandwidths. The analyzer automatically chooses the appropriate trigger path based on the hardware configuration and other settings of the analyzer.

Key Path	Trigger
Example	TRIG:SOUR RFB Swept SA measurement TRIG:<meas>:SOUR RFB Measurements other than Swept SA
State Saved	Saved in instrument state
Status Bits/OPC dependencies	The Status Operation Register bit 5 "Waiting for Trigger" is set at the same time as the Sweeping or Measuring bit is set. It is cleared when the trigger actually occurs (that is, after the trigger event occurs and all the applicable trigger criteria have been met). A corresponding pop-up message ("Waiting for trigger") is generated if no trigger signal appears after approximately 2 sec. This message goes away when a trigger signal appears.

Backwards Compatibility Notes	The legacy command: :TRIGger[:SEQuence]:RFBurst:FSElectivity[:STATe] OFF ON 0 1 is not supported in the X-Series, as the hardware to do Frequency Selective burst triggers does not exist in X-Series.
Initial S/W Revision	Prior to A.02.00
Modified at S/W Revision	A.04.00

Absolute Trigger Level

Sets the absolute trigger level for the RF burst envelope.

When using the External Mixing path, the Absolute Trigger Level is uncalibrated because the factory default was set to accommodate the expected IF levels for the RF path.

Key Path	Trigger, RF Burst
Scope	Meas Global
Remote Command	:TRIGger[:SEQuence]:RFBurst:LEVel:ABSolute <ampl> :TRIGger[:SEQuence]:RFBurst:LEVel:ABSolute?
Example	TRIG:RFB:LEV:ABS 10 dBm sets the trigger level of the RF burst envelope signal to the absolute level of 10 dBm
Notes	Sending this command does not switch the setting from relative to absolute; to switch it you need to send the :TRIGger[:SEQuence]:RFBurst:LEVel:TYPE command, below. Amplitude Corrections are not taken into account by the Absolute Trigger Level. For example, if you have given yourself effective gain with an amplitude correction factor, the Absolute Trigger will not fire until you have set the trigger level that far below the displayed signal level, rather than simply to the displayed signal level. This is only true for Amplitude Corrections, not External Gain or Ref Level Offset functions. If mode is Bluetooth, the default value is -50 dBm.
Couplings	This same level is used for the RF Burst trigger source in the Trigger menu, for the RF Burst selection in the Periodic Timer sync source (in the Trigger menu and in the Gate Source menu), and also for the RF Burst selection in the Gate Source menu
Preset	-20 dBm
State Saved	Saved in instrument state
Min	-200 dBm
Max	100 dBm
Default Unit	depends on the current selected Y-Axis unit
Backwards Compatibility SCPI	:TRIGger[:SEQuence]:FRAME:RFBurst:LEVel:ABSolute
Initial S/W Revision	Prior to A.02.00
Modified at S/W Revision	A.04.00

Key Path	Trigger, RF Burst
Remote Command	:TRIGger[:SEquence]:RFBurst:LEVel:TYPE ABSolute RELative :TRIGger[:SEquence]:RFBurst:LEVel:TYPE?
Example	TRIG:RFB:LEV:TYPE REL sets the trigger level type of the RF burst trigger to Relative.
Preset	ABSolute
State Saved	Saved in instrument state
Initial S/W Revision	Prior to A.02.00
Modified at S/W Revision	A.04.00

Relative Trigger Level

Sets the relative trigger level for the RF burst envelope.

In some models, the relative burst trigger function is implemented in hardware. In other models, without the advanced triggering hardware required, the relative burst trigger function is implemented in software in some measurements, and is unavailable in other measurements.

When implemented in software, the relative RF Burst trigger function is implemented as follows:

1. The measurement starts with the absolute RF Burst trigger setting. If it cannot get a trigger with that level, auto trigger fires and the acquisition starts anyway. After the acquisition, the measurement searches for the peak in the acquired waveform and saves it.
2. Now, in the next cycle of the measurement, the measurement determines a new absolute RF Burst level based on the peak value from the first measurement and the Relative RF Burst Trigger Level (always 0 or negative dB) set by the user. The following formula is used:
3. absolute RF Burst level = peak level of the previous acquisition + relative RF Burst level
4. If the new absolute RF Burst level differs from the previous by more than 0.5 dB, the new level is sent to the hardware; otherwise it is not updated (to avoid slowing down the acquisition)

Steps 2 and 3 repeat for subsequent measurements.

Key Path	Trigger, RF Burst
Scope	Meas Global
Remote Command	:TRIGger[:SEquence]:RFBurst:LEVel:RELative <rel_ampl> :TRIGger[:SEquence]:RFBurst:LEVel:RELative?
Example	TRIG:RFB:LEV:REL -10 dB sets the trigger level of the RF burst envelope signal to the relative level of -10 dB
Notes	Sending this command does not switch the setting from absolute to relative; to switch it you need to send the :TRIGger[:SEquence]:RFBurst:LEVel:TYPE command, above. The relative trigger level is not available in some measurements. In those measurements the RELative parameter, and the :TRIGger[:SEquence]:RFBurst:LEVel:TYPE

	command (above), will generate an error if sent.
Dependencies	This key is grayed out and Absolute Trigger Level selected if the required hardware is not present in your analyzer and the current measurement does not support Relative triggering.
Preset	-6 dB GSM: -25 dB
State Saved	Saved in instrument state
Min	-45 dB
Max	0 dB
Default Unit	dB or dBc
Backwards Compatibility SCPI	:TRIGger[:SEquence]:RFBurst:LEVel
	This legacy command is aliased to :TRIGger[:SEquence]:RFBurst:LEVel:RELative because the PSA had ONLY relative burst triggering
Initial S/W Revision	Prior to A.02.00
Modified at S/W Revision	A.04.00

Trigger Slope

It is set positive to trigger on a rising edge and negative to trigger on a falling edge.

Key Path	Trigger, RF Burst
Remote Command	:TRIGger[:SEquence]:RFBurst:SLOPe POSitive NEGative :TRIGger[:SEquence]:RFBurst:SLOPe?
Example	TRIG:RFB:SLOP NEG
Couplings	This same slope is used in the RF Burst selection for the trigger source in the Trigger menu and for the period timer sync source (in the Trigger menu and in the Gate Source menu).
Preset	POSitive
State Saved	Saved in instrument state
Backwards Compatibility SCPI	:TRIGger[:SEquence]:FRAME:RFBurst:SLOPe
Backwards Compatibility Notes	The legacy :TRIGger[:SEquence]:SLOPe command affects the slopes for the VID, LINE, EXT1, EXT2, and RFB triggers.
Initial S/W Revision	Prior to A.02.00

Trig Delay

Controls a time delay during which the analyzer will wait to begin a sweep after meeting the trigger criteria. You can use negative delay to pre-trigger the instrument in time domain or FFT, but not in swept spans.

Key Path	Trigger, RF Burst
Remote Command	:TRIGger[:SEquence]:RFBurst:DElay <time> :TRIGger[:SEquence]:RFBurst:DElay? :TRIGger[:SEquence]:RFBurst:DElay:STATE OFF ON 0 1 :TRIGger[:SEquence]:RFBurst:DElay:STATE?
Example	TRIG:RFB:DEL:STAT ON TRIG:RFB:DEL 100 ms
Notes	Video trigger delay may be set to negative values, in time domain, FFT and even swept. It makes intuitive sense in time domain and works well in FFT mode where the bandwidth of the filter before the video trigger is about 1.25 span. In swept spans, negative settings of Trig Delay are treated as a zero setting within the internal hardware and the advisory message "Neg. Trig Delay unavailable in Swept Mode, zero delay used." is generated when such a delay is set.
Preset	Off, 1.000 us
State Saved	Saved in instrument state
Min	-150 ms
Max	500 ms
Default Unit	s
Backwards Compatibility Notes	The legacy :TRIGger[:SEquence]:DElay command affects the delay for the VID, LINE, EXT1, EXT2, and RFB triggers.
Initial S/W Revision	Prior to A.02.00

Periodic Timer (Frame Trigger)

Pressing this key, when it is not selected, selects the internal periodic timer signal as the trigger. Triggering occurrences are set by the **Period** parameter, which is modified by the **Sync Source** and **Offset**. Pressing this key, when it is already selected, accesses the periodic timer trigger setup functions.

If you do not have a sync source selected (it is Off), then the internal timer will not be synchronized with any external timing events.

Key Path	Trigger
Example	TRIG:SOUR FRAM Swept SA measurement TRIG:<meas>:SOUR FRAM Measurements other than Swept SA
State Saved	Saved in instrument state
Readback	[Sync: <value of Sync Source>], for example, [Sync: External 1]
Status Bits/OPC dependencies	The Status Operation Register bit 5 "Waiting for Trigger" is set at the same time as the Sweeping or Measuring bit is set. It is cleared when the trigger actually occurs (that is, after the trigger event occurs and all the applicable trigger criteria have been met). A corresponding pop-up message ("Waiting for trigger") is generated if no trigger signal appears after approximately 2 sec. This message goes away when a trigger signal appears.
Initial S/W Revision	Prior to A.02.00

Periodic Timer Triggering:

This feature selects the internal periodic timer signal as the trigger. Trigger occurrences are set by the **Periodic Timer** parameter, which is modified by the **Sync Source** and **Offset**.

The figure below shows the action of the periodic timer trigger. Before reviewing the figure, we'll explain some uses for the periodic trigger.

A common application is measuring periodic burst RF signals for which a trigger signal is not easily available. For example, we might be measuring a TDMA radio which bursts every 20 ms. Let's assume that the 20 ms period is very consistent. Let's also assume that we do not have an external trigger source available that is synchronized with the period, and that the signal-to-noise ratio of the signal is not high enough to provide a clean RF burst trigger at all of the analysis frequencies. For example, we might want to measure spurious transmissions at an offset from the carrier that is larger than the bandwidth of the RF burst trigger. In this application, we can set the Periodic Timer to a 20.00 ms period and adjust the offset from that timer to position our trigger just where we want it. If we find that the 20.00 ms is not exactly right, we can adjust the period slightly to minimize the drift between the period timer and the signal to be measured.

A second way to use this feature would be to use **Sync Source** temporarily, instead of **Offset**. In this case, we might tune to the signal in a narrow span and use the RF Burst trigger to synchronize the periodic timer. Then we would turn the sync source off so that it would not miss-trigger. Miss-triggering can occur when we are tuned so far away from the RF burst trigger that it is no longer reliable.

A third example would be to synchronize to a signal that has a reference time element of much longer period than the period of interest. In some CDMA applications, it is useful to look at signals with a short periodicity, by synchronizing that periodicity to the "even-second clock" edge that happens every two seconds. Thus, we could connect the even-second clock trigger to Ext1 and use then Ext1 as the sync source for the periodic timer.

The figure below illustrates this third example. The top trace represents the even-second clock. It causes the periodic timer to synchronize with the leading edge shown. The analyzer trigger occurs at a time delayed by the accumulated offset from the period trigger event. The periodic timer continues to run, and triggers continue to occur, with a periodicity determined by the analyzer time base. The timer output (labeled "late event") will drift away from its ideal time due to imperfect matching between the time base of the signal being measured and the time base of the analyzer, and also because of imperfect setting of the period parameter. But the synchronization is restored on the next even-second clock event. ("Accumulated offset" is described in the in the **Offset** function section.)

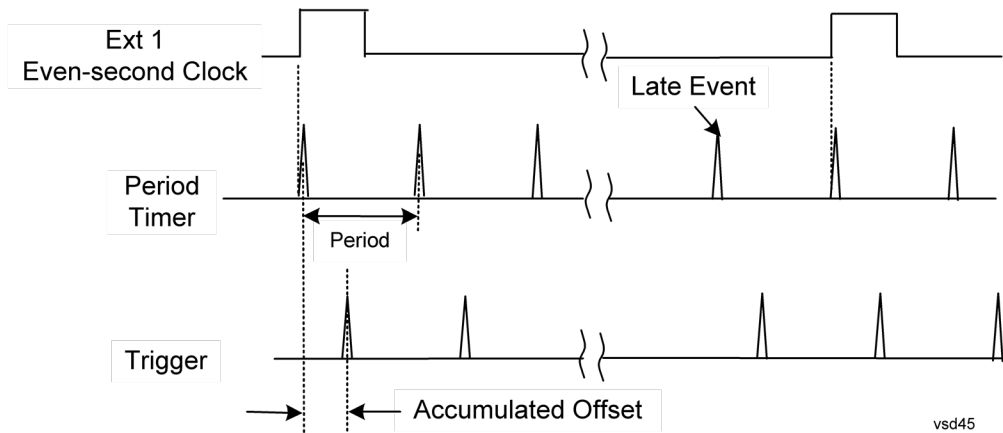

Period

Sets the period of the internal periodic timer clock. For digital communications signals, this is usually set to the frame period of your current input signal. In the case that sync source is not set to OFF, and the external sync source rate is changed for some reason, the periodic timer is synchronized at the every external synchronization pulse by resetting the internal state of the timer circuit.

Key Path	Trigger, Periodic Timer
Remote Command	:TRIGger[:SEquence]:FRAMe:PERiod <time> :TRIGger[:SEquence]:FRAMe:PERiod?
Example	TRIG:FRAM:PER 100 ms
Dependencies	The invalid data indicator turns on when the period is changed, until the next sweep/measurement completes.
Couplings	The same period is used in the Gate Source selection of the period timer.
Preset	20 ms GSM: 4.615383
State Saved	Saved in instrument state
Min	100.000 ns
Max	559.0000 ms
Default Unit	S
Initial S/W Revision	Prior to A.02.00

Offset

Adjusts the accumulated offset between the periodic timer events and the trigger event. Adjusting the accumulated offset is different than setting an offset, and requires explanation.

The periodic timer is usually not synchronized with any external events, so the timing of its output events has no absolute meaning. Since the timing relative to external events (RF signals) is important, you need to be able to adjust (offset) it. However, you have no direct way to see when the periodic timer events occur. All that you can see is the trigger timing. When you want to adjust the trigger timing, you will be changing

the internal offset between the periodic timer events and the trigger event. Because the absolute value of that internal offset is unknown, we will just call that the accumulated offset. Whenever the Offset parameter is changed, you are changing that accumulated offset. You can reset the displayed offset using Reset Offset Display. Changing the display does not change the value of the accumulated offset, and you can still make additional changes to accumulated offset.

To avoid ambiguity, we define that an increase in the "offset" parameter, either from the knob or the SCPI adjust command, serves to delay the timing of the trigger event.

Key Path	Trigger, Periodic Timer
Remote Command	:TRIGger[:SEquence]:FRAMe:OFFSet <time> :TRIGger[:SEquence]:FRAMe:OFFSet?
Example	TRIG:FRAM:OFFS 1.2 ms
Notes	<p>The front panel interface (for example, the knob), and this command, adjust the accumulated offset, which is shown on the active function display. However, the actual amount sent to the hardware each time the offset is updated is the delta value, that is, the current accumulated offset value minus the previous accumulated offset value. Note that the accumulated offset value is essentially arbitrary; it represents the accumulated offset from the last time the offset was zeroed (with the Reset Offset Display key).</p> <p>Note that this command does not change the period of the trigger waveform. Note also that Offset is used only when the sync source is set to OFF, otherwise delay is used, see section "Trig Delay" on page 280.</p> <p>An increase in the "offset" parameter, either from the knob or the SCPI adjust command, serves to delay the timing of the trigger event.</p>
Notes	<p>When the SCPI command is sent the value shown on the key (and the Active Function, if this happens to be the active function) is updated with the new value. However, the actual amount sent to the hardware is the delta value, that is, the current accumulated offset value minus the previous accumulated offset value.</p> <p>The SCPI query simply returns the value currently showing on the key.</p>
Dependencies	The invalid data indicator turns on when the offset is changed, until the next sweep/measurement completes.
Couplings	The same offset is used in the Gate Source selection of the period timer.
Preset	0 s
State Saved	Saved in instrument state
Min	-10.000 s
Max	10.000 s
Default Unit	S
Initial S/W Revision	Prior to A.02.00

Offset Adjust (Remote Command Only)

This remote command does not work at all like the related front panel keys. This command lets you advance the phase of the frame trigger by the amount you specify.

It does not change the period of the trigger waveform. If the command is sent multiple times, it advances the phase of the frame trigger an additional amount each time it is sent. Negative numbers are permitted.

Remote Command	:TRIGger[:SEquence]:FRAMe:ADJust <time>
Example	TRIG:FRAM:ADJ 1.2 ms
Notes	Note also that Offset is used only when the sync source is set to OFF, otherwise delay is used, see section " Trig Delay " on page 280 An increase in the "offset" parameter, either from the knob or the SCPI adjust command, serves to delay the timing of the trigger event.
Notes	The front panel interface (for example, the knob) and the :TRIG:FRAM:OFFS command adjust the accumulated offset, which is shown on the active function display. However, the actual amount sent to the hardware is the delta value, that is, the current offset value minus the previous offset value. When the SCPI command is sent the value shown on the key (and the Active Function, if this happens to be the active function) is updated by increasing it (or decreasing it if the value sent is negative) by the amount specified in the SCPI command. This is a "command only" SCPI command, with no query.
Dependencies	The invalid data indicator turns on when the offset is changed, until the next sweep/measurement completes.
Couplings	The same offset is used in the Gate Source selection of the period timer.
Preset	0 s
State Saved	Saved in instrument state
Min	-10.000 s
Max	10.000 s
Default Unit	S
Initial S/W Revision	Prior to A.02.00

Reset Offset Display

Resets the value of the periodic trigger offset display setting to 0.0 seconds. The current displayed trigger location may include an offset value defined with the Offset key. Pressing this key redefines the currently displayed trigger location as the new trigger point that is 0.0 s offset. The Offset key can then be used to add offset relative to this new timing.

Key Path	Trigger, Periodic Timer
Remote Command	:TRIGger[:SEquence]:FRAMe:OFFSet:DISPlay:RESet
Example	TRIG:FRAM:OFFS:DISP:RES
Initial S/W Revision	Prior to A.02.00

Sync Source

Selects a signal source for you to synchronize your periodic timer trigger to, otherwise you are triggering at some arbitrary location in the frame. Synchronization reduces the precision requirements on the setting of

the period.

For convenience you may adjust the level and slope of the selected sync source in a conditional branch setup menu accessed from the Sync Source menu. Note that these settings match those in the **Trigger** and **Gate Source** menus; that is, each trigger source has only one value of level and slope, regardless of which menu it is accessed from.

Key Path	Trigger, Periodic Timer
Remote Command	:TRIGger[:SEquence]:FRAMe:SYNC EXTernal1 EXTernal2 RFBurst OFF :TRIGger[:SEquence]:FRAMe:SYNC?
Example	TRIG:FRAM:SYNC EXT2
Dependencies	In some models, there is no second External input. In these models, the External 2 key is blanked and the EXTernal2 parameter will generate a “Hardware missing; Not available for this model number” message.
Preset	Off GSM/EDGE, MSR,LTE,LTETDD: RFBurst
State Saved	Saved in instrument state
Readback	The current setting is read back to this key and it is also Readback to the previous Periodic Timer trigger key.
Backwards Compatibility SCPI	:TRIGger[:SEquence]:FRAMe:SYNC EXTernal
Initial S/W Revision	Prior to A.02.00
Modified at S/W Revision	A.03.00, A.14.00

Off

Turns off the sync source for your periodic trigger. With the sync source off, the timing will drift unless the signal source frequency is locked to the analyzer frequency reference.

Key Path	Trigger, Periodic Timer, Sync Source
Example	TRIG:FRAM:SYNC OFF
Readback	Off
Initial S/W Revision	Prior to A.02.00

External 1

Pressing this key, when it is not selected, selects an external input signal as the trigger. A new sweep/measurement will start when the external trigger condition is met using the external 1 input connector on the rear panel.

Pressing this key, when it is already selected, accesses the external 1 trigger setup menu.

Key Path	Trigger
Example	TRIG:SOUR EXT1 Swept SA measurement TRIG:<meas>:SOUR EXT1 Measurements other than Swept SA
Dependencies	Grayed out if in use by Point Trigger in the Source Setup menu. Forced to Free Run if already selected and Point Trigger is set to External 1.
State Saved	Saved in instrument state
Status Bits/OPC dependencies	The Status Operation Register bit 5 "Waiting for Trigger" is set at the same time as the Sweeping or Measuring bit is set. It is cleared when the trigger actually occurs (that is, after the trigger event occurs and all the applicable trigger criteria have been met). A corresponding pop-up message ("Waiting for trigger") is generated if no trigger signal appears after approximately 2 sec. This message goes away when a trigger signal appears.
Initial S/W Revision	Prior to A.02.00

Trigger Level

Sets the value where the external 1 trigger input will trigger a new sweep/measurement.

Key Path	Trigger, External 1
Remote Command	:TRIGger[:SEquence]:EXTernal1:LEVel <level> :TRIGger[:SEquence]:EXTernal1:LEVel?
Example	TRIG:EXT1:LEV 0.4 V
Couplings	This same level is used for the Ext1 trigger source in the Trigger menu, for the Ext1 selection in the Periodic Timer sync source (in the Trigger menu and in the Gate Source menu), and also for the Ext1 selection in the Gate Source menu.
Preset	1.2 V
State Saved	Saved in instrument state
Min	-3.5V
Max	3.5V
Default Unit	V
Backwards Compatibility SCPI	:TRIGger[:SEquence]:EXTernal:LEVel For backward compatibility, the parameter EXTernal is mapped to EXTernal1
Backwards Compatibility SCPI	:TRIGger[:SEquence]:FRAMe:EXTernal1:LEVel
Initial S/W Revision	Prior to A.02.00

Trig Slope

Controls the trigger polarity. It is set positive to trigger on a rising edge and negative to trigger on a falling edge.

Key Path	Trigger, External 1
Remote Command	:TRIGger[:SEquence]:EXTernal1:SLOPe POSitive NEGative :TRIGger[:SEquence]:EXTernal1:SLOPe?
Example	TRIG:EXT1:SLOP NEG
Couplings	This same slope is used in the Ext1 selection for the trigger source in the Trigger menu and for the period timer sync source (in the Trigger menu and in the Gate Source menu).
Preset	POSitive
State Saved	Saved in instrument state
Backwards Compatibility SCPI	:TRIGger[:SEquence]:EXTernal:SLOPe For backward compatibility, the parameter EXTernal is mapped to EXTernal1
Backwards Compatibility SCPI	:TRIGger[:SEquence]:FRaME:EXTernal1:SLOPe
Backwards Compatibility Notes	The legacy :TRIGger[:SEquence]:SLOPe command affects the slopes for the VID, LINE, EXT1, EXT2, and RFB triggers.
Initial S/W Revision	Prior to A.02.00

External 2

Pressing this key, when it is not selected, selects an external input signal as the trigger. A new sweep/measurement will start when the external trigger condition is met using the external 2 input connector. The external trigger 2 input connector is on the rear panel.

Pressing this key, when it is already selected, accesses the external 2 trigger setup menu.

Key Path	Trigger
Example	TRIG:SOUR EXT2 Swept SA measurement TRIG:<meas>:SOUR EXT2 Measurements other than Swept SA
Dependencies	In some models, there is no second External input. In these models, the External 2 key is blanked and the EXTernal2 parameter will generate a "Hardware missing; Not available for this model number" message. Grayed out if in use by Point Trigger in the Source Setup menu. Forced to Free Run if already selected and Point Trigger is set to External 2.
State Saved	Saved in instrument state
Status Bits/OPC dependencies	The Status Operation Register bit 5 "Waiting for Trigger" is set at the same time as the Sweeping or Measuring bit is set. It is cleared when the trigger actually occurs (that is, after the trigger event occurs and all the applicable trigger criteria have been met). A corresponding pop-up message ("Waiting for trigger") is generated if no trigger signal appears after approximately 2 sec. This message goes away when a trigger signal appears.

Initial S/W Revision	Prior to A.02.00
Modified at S/W Revision	A.03.00

Trigger Level

Sets the value where the external 2 trigger input will trigger a new sweep/measurement.

Key Path	Trigger, External 2
Remote Command	:TRIGger[:SEquence]:EXTernal2:LEVel :TRIGger[:SEquence]:EXTernal2:LEVel?
Example	TRIG:EXT2:LEV 1.1 V
Couplings	This same level is used for the Ext2 trigger source in the Trigger menu, for the Ext2 selection in the Periodic Timer sync source (in the Trigger menu and in the Gate Source menu), and also for the Ext2 selection in the Gate Source menu.
Preset	1.2 V
State Saved	Saved in instrument state
Min	-3.5V
Max	3.5V
Default Unit	V
Backwards Compatibility SCPI	:TRIGger[:SEquence]:FRAMe:EXTernal2:LEVel
Initial S/W Revision	Prior to A.02.00

Trig Slope

Controls the trigger polarity. It is set positive to trigger on a rising edge and negative to trigger on a falling edge.

Key Path	Trigger, External 2
Remote Command	:TRIGger[:SEquence]:EXTernal2:SLOPe POSitive NEGative :TRIGger[:SEquence]:EXTernal2:SLOPe?
Example	TRIG:EXT2:SLOP NEG
Couplings	This same slope is used in the Ext2 selection for the trigger source in the Trigger menu and for the period timer sync source (in the Trigger menu and in the Gate Source menu).
Preset	POSitive
State Saved	Saved in instrument state
Backwards Compatibility SCPI	:TRIGger[:SEquence]:FRAMe:EXTernal2:SLOPe

Backwards Compatibility Notes	The legacy :TRIGger[:SEQuence]:SLOPe command affects the slopes for the VID, LINE, EXT1, EXT2, and RFB triggers.
Initial S/W Revision	Prior to A.02.00

RF Burst

Pressing this key, when it is not selected, selects the RF Burst as the trigger. A new sweep/measurement will start when an RF burst envelope signal is identified from the signal at the RF Input connector. Pressing this key, when it is already selected, accesses the RF Burst trigger setup menu.

In some models, a variety of burst trigger circuitry is available, resulting in various available burst trigger bandwidths. The analyzer automatically chooses the appropriate trigger path based on the hardware configuration and other settings of the analyzer.

Key Path	Trigger
Example	TRIG:SOUR RFB Swept SA measurement TRIG:< meas>:SOUR RFB Measurements other than Swept SA
State Saved	Saved in instrument state
Status Bits/OPC dependencies	The Status Operation Register bit 5 "Waiting for Trigger" is set at the same time as the Sweeping or Measuring bit is set. It is cleared when the trigger actually occurs (that is, after the trigger event occurs and all the applicable trigger criteria have been met). A corresponding pop-up message ("Waiting for trigger") is generated if no trigger signal appears after approximately 2 sec. This message goes away when a trigger signal appears.
Backwards Compatibility Notes	The legacy command: :TRIGger[:SEQuence]:RFBurst:FSElectivity[:STATe] OFF ON 0 1 is not supported in the X-Series, as the hardware to do Frequency Selective burst triggers does not exist in X-Series.
Initial S/W Revision	Prior to A.02.00
Modified at S/W Revision	A.04.00

Absolute Trigger Level

Sets the absolute trigger level for the RF burst envelope.

When using the External Mixing path, the Absolute Trigger Level is uncalibrated because the factory default was set to accommodate the expected IF levels for the RF path.

Key Path	Trigger, RF Burst
Scope	Meas Global
Remote Command	:TRIGger[:SEQuence]:RFBurst:LEVel:ABSolute <ampl> :TRIGger[:SEQuence]:RFBurst:LEVel:ABSolute?
Example	TRIG:RFB:LEV:ABS 10 dBm

	sets the trigger level of the RF burst envelope signal to the absolute level of 10 dBm
Notes	<p>Sending this command does not switch the setting from relative to absolute; to switch it you need to send the :TRIGger[:SEquence]:RFBurst:LEVel:TYPE command, below.</p> <p>Amplitude Corrections are not taken into account by the Absolute Trigger Level. For example, if you have given yourself effective gain with an amplitude correction factor, the Absolute Trigger will not fire until you have set the trigger level that far below the displayed signal level, rather than simply to the displayed signal level. This is only true for Amplitude Corrections, not External Gain or Ref Level Offset functions.</p> <p>If mode is Bluetooth, the default value is -50 dBm.</p>
Couplings	This same level is used for the RF Burst trigger source in the Trigger menu, for the RF Burst selection in the Periodic Timer sync source (in the Trigger menu and in the Gate Source menu), and also for the RF Burst selection in the Gate Source menu
Preset	-20 dBm
State Saved	Saved in instrument state
Min	-200 dBm
Max	100 dBm
Default Unit	depends on the current selected Y-Axis unit
Backwards Compatibility SCPI	:TRIGger[:SEquence]:FRAMe:RFBurst:LEVel:ABSolute
Initial S/W Revision	Prior to A.02.00
Modified at S/W Revision	A.04.00

Key Path	Trigger, RF Burst
Remote Command	:TRIGger[:SEquence]:RFBurst:LEVel:TYPE ABSolute RELative :TRIGger[:SEquence]:RFBurst:LEVel:TYPE?
Example	TRIG:RFB:LEV:TYPE REL sets the trigger level type of the RF burst trigger to Relative.
Preset	ABSolute
State Saved	Saved in instrument state
Initial S/W Revision	Prior to A.02.00
Modified at S/W Revision	A.04.00

Trigger Slope

It is set positive to trigger on a rising edge and negative to trigger on a falling edge.

Key Path	Trigger, RF Burst
Remote Command	:TRIGger[:SEquence]:RFBurst:SLOPe POSitive NEGative :TRIGger[:SEquence]:RFBurst:SLOPe?

Example	TRIG:RFB:SLOP NEG
Couplings	This same slope is used in the RF Burst selection for the trigger source in the Trigger menu and for the period timer sync source (in the Trigger menu and in the Gate Source menu).
Preset	POSitive
State Saved	Saved in instrument state
Backwards Compatibility SCPI	:TRIGger[:SEQuence]:FRAMe:RFBurst:SLOPe
Backwards Compatibility Notes	The legacy :TRIGger[:SEQuence]:SLOPe command affects the slopes for the VID, LINE, EXT1, EXT2, and RFB triggers.
Initial S/W Revision	Prior to A.02.00

Trig Delay

This setting delays the measurement timing relative to the Periodic Timer.

Key Path	Trigger, Periodic Timer
Remote Command	:TRIGger[:SEQuence]:FRAMe:DELay <time> :TRIGger[:SEQuence]:FRAMe:DELay? :TRIGger[:SEQuence]:FRAMe:DELay:STATe OFF ON 0 1 :TRIGger[:SEQuence]:FRAMe:DELay:STATe?
Notes	Note that delay is used when the sync source is not set to OFF. If the sync source is set to OFF, offset is used.
Preset	Off, 1.000 us
State Saved	Saved in instrument state
Min	-150 ms
Max	+500 ms
Default Unit	s
Initial S/W Revision	Prior to A.02.00

Auto/Holdoff

Opens up a menu that lets you adjust Auto Trigger and Trigger Holdoff parameters

Key Path	Trigger
Readback line	Displays a summary of the Auto Trig and Holdoff settings, in square brackets First line: Auto Off or Auto On Second Line: "Hldf" followed by: <ul style="list-style-type: none"> • If Holdoff is Off, readback Off • If Holdoff On and Type = Normal, readback value

- If Holdoff On and Type = Above, readback value followed by AL
- If Holdoff On and Type = Below, readback value followed by BL
- If Holdoff Type selection is not supported by the current measurement, Holdoff Type is always Normal

Initial S/W Revision	A.02.00
----------------------	---------

Auto Trig

Sets the time that the analyzer will wait for the trigger conditions to be met. If they are not met after that much time, then the analyzer is triggered anyway.

Key Path	Trigger, Auto/Holdoff
Remote Command	:TRIGger[:SEquence]:ATRigger <time> :TRIGger[:SEquence]:ATRigger? :TRIGger[:SEquence]:ATRigger:STATE OFF ON 0 1 :TRIGger[:SEquence]:ATRigger:STATE?
Example	TRIG:ATR:STAT ON TRIG:ATR 100 ms
Notes	The "time that the analyzer will wait" starts when the analyzer is ready for a trigger, which may be hundreds of ms after the data acquisition for a sweep is done. The "time" ends when the trigger condition is satisfied, not when the delay ends.
Preset	Off, 100 ms
State Saved	Saved in instrument state
Min	1 ms
Max	100 s
Default Unit	s
Initial S/W Revision	Prior to A.02.00

Trig Holdoff

Sets the holdoff time between triggers. When the trigger condition is satisfied, the trigger occurs, the delay begins, and the holdoff time begins. New trigger conditions will be ignored until the holdoff time expires. For a free-running trigger, the holdoff value is the minimum time between triggers.

Key Path	Trigger, Auto/Holdoff
Remote Command	:TRIGger[:SEquence]:HOLDoff <time> :TRIGger[:SEquence]:HOLDoff? :TRIGger[:SEquence]:HOLDoff:STATE OFF ON 0 1 :TRIGger[:SEquence]:HOLDoff:STATE?
Example	TRIG:HOLD:STAT ON

	TRIG:HOLD 100 ms
Dependencies	Unavailable if the selected Input is BBIQ. If this is the case, the key is grayed out if it is pressed the informational message "Feature not supported for this Input" is displayed. If the SCPI command is sent, the error "Settings conflict; Feature not supported for this Input" is generated.
Preset	Off, 100 ms
State Saved	Saved in instrument state
Min	0 s
Max	0.5 s
Default Unit	s
Initial S/W Revision	Prior to A.02.00

Internal

Pressing this key, when it is not selected, selects the signal from internal source module as the trigger. A new sweep/measurement will start when detecting the signal from internal source module.

Prerequisite of internal trigger occurring is there is trigger output from internal source. So user need configure source trigger output before selecting trigger source as internal. To enable source trigger output, output trigger should not be off if internal source works as list sequence mode and Trig 2 Out should not be off if internal source works as MXG mode. Otherwise, no trigger occurs and measurement does not start.

Note: internal trigger type is only available for M9420A.

Key Path	Trigger
Example	TRIG:SOUR INT Swept SA measurement TRIG:<meas>:SOUR INT Measurements other than Swept SA
Notes	See section Error! Reference source not found.
State Saved	Saved in instrument state
Status Bits/OPC dependencies	See section Error! Reference source not found. The Status Operation Register bit 5 "Waiting for Trigger" is set at the same time as the Sweeping or Measuring bit is set. It is cleared when the trigger actually occurs (that is, after the trigger event occurs and all the applicable trigger criteria have been met). A corresponding pop-up message ("Waiting for trigger") is generated if no trigger signal appears after approximately 2 sec. This message goes away when a trigger signal appears.
Initial S/W Revision	Prior to M.16.25

8 Channel Power Measurement

The Channel Power measurement is used to find the total power present in a specified bandwidth. The power spectral density (the power in the signal normalized to 1 Hz) is also reported (In WLAN mode or WLAN radio standard in SA mode, the peak power spectral density for 1 MHz is reported). For measurement results and views, see ["View/Display" on page 542](#).

This topic contains the following sections:

["Measurement Commands for Channel Power" on page 284](#)

["Remote CommandResults for Channel Power Measurement" on page 285](#)

Measurement Commands for Channel Power

These commands are used to measure the total rms power in a specified integration bandwidth.

Use `:INSTrument:SElect` to set the mode.

```
:CONFigure:CHPower
:CONFigure:CHPower:NDEfault
:INITiate:CHPower
:FETCh:CHPower[n]?
:MEASure:CHPower[n]?
:READ:CHPower[n]?
:FETCh:CHPower:CHPower?
:MEASure:CHPower:CHPower?
:READ:CHPower:CHPower?
:FETCh:CHPower:DENSity?
:MEASure:CHPower:DENSity?
:READ:CHPower:DENSity
```

For more measurement related commands, see the `SENSE` subsystem, and the section `Remote Measurement Functions@29978`.

Remote CommandResults for Channel Power Measurement

For WLAN, see [Error! Reference source not found.](#)

Command	Return Value
FETCh:CHPower[n]?	Refer to the table below.
MEASure:CHPower[n]?	
READ:CHPower[n]?	
FETCh:CHPower:CHPower?	Returns the Channel Power (dBm) (BW compatibility functionality)
MEASure:CHPower:CHPower?	
READ:CHPower:CHPower?	
FETCh:CHPower:DENSity?	Returns the Power Spectral Density (dBm/Hz) (BW compatibility functionality)
MEASure:CHPower:DENSity?	
READ:CHPower:DENSity?	

n	Results Returned
n=1 (or not specified)	Returns scalar results: <ol style="list-style-type: none"> 1. Channel Power is a floating point number representing the total channel power in the specified integration bandwidth. 2. PSD (Power Spectral Density) is the power in the specified unit bandwidth. The unit bandwidth is selected by the PSD Unit parameter in either dBm/Hz or dBm/MHz.
2	Returns floating point numbers that are the captured trace data of the power (in dBm/resolution BW) of the signal. The frequency span of the captured trace data is specified by the Span key.

Remote Command Results for WLAN Channel Power Measurement

n	Results Returned
n=1 (or not specified)	<p>Returns scalar results:</p> <p>When the radio standard is NOT WLAN 802.11ac 80 + 80 MHz:</p> <ol style="list-style-type: none"> 1. Channel Power is a floating point number representing the total channel power in the specified integration bandwidth. 2. PSD (Power Spectral Density) is the power in the specified unit bandwidth. The unit bandwidth is selected by the PSD Unit parameter in either dBm/Hz or dBm/MHz. <p>When the radio standard is WLAN 802.11ac 80 + 80 MHz:</p> <ol style="list-style-type: none"> 1. Channel Power of the carrier of which the center frequency is indicated by Freq Segment 1 is a floating point number representing the total channel power of the first segment in the specified integration bandwidth. 2. PSD (Power Spectral Density) of the carrier of which the center frequency is indicated by Freq Segment 1 is the power in the specified unit bandwidth of the first segment. The unit bandwidth is selected by the PSD Unit parameter in either dBm/Hz or dBm/MHz. 3. Channel Power of the carrier of which the center frequency is indicated by Freq Segment 2 is a floating point number representing the total channel power of the second segment in the specified integration bandwidth. 4. PSD (Power Spectral Density) of the carrier of which the center frequency is indicated by Freq Segment 2 is the power in the specified unit bandwidth of the second segment. The unit bandwidth is selected by the PSD Unit parameter in either dBm/Hz or dBm/MHz.
2	Returns floating point numbers that are the captured trace data of the power (in dBm/resolution BW) of the signal. The frequency span of the captured trace data is specified by the Span key.

Key Path	Meas
Mode	SA, WCDMA, C2K, WIMAX OFDMA, 1xEVDO, DVB-T/H, DTMB (CTTB), ISDB-T, CMMB, LTE, LTETDD, Digital Cable TV, WLAN, MSR, LTEAFDD, LTEATDD
Initial S/W Revision	Prior to A.02.00
Modified at S/W Revision	A.03.00

AMPTD Y Scale

Accesses a menu of functions that enable you to set the vertical scale parameters. The parameter values are measurement independent, except all Attenuation values and the Internal Preamp selection, which are the same across all measurements.

Key Path	Front-panel key
Initial S/W Revision	Prior to A.02.00

Ref Value

Sets the value for the absolute power reference. However, since the Auto Scaling is defaulted to On, this value is automatically determined by the measurement result. When you set a value manually, Auto Scaling automatically changes to Off.

Key Path	AMPTD Y Scale
Mode	SA, WCDMA, C2K, WIMAX OFDMA, 1xEVDO, DVB-T/H, DTMB (CTTB), ISDB-T, CMMB, LTE, LTETDD, Digital Cable TV, WLAN, MSR, LTEAFDD, LTEATDD
Remote Command	:DISPlay:CHPower:VIEW[1]:WINDow[1]:TRACe:Y[:SCALe]:RLEVel <real> :DISPlay:CHPower:VIEW[1]:WINDow[1]:TRACe:Y[:SCALe]:RLEVel?
Example	DISP:CHP:VIEW:WIND:TRAC:Y:RLEV 10 dBm DISP:CHP:VIEW:WIND:TRAC:Y:RLEV?
Notes	You must be in the Spectrum Analysis mode, W-CDMA mode, cdma2000 mode, DVB-T/H mode, DTMB (CTTB) mode, ISDB-T mode, CMMB mode, Digital Cable TV mode, LTD mode, LTE TDD mode, WLAN mode, 1xEVDO mode, MSR, LTE-Advanced FDD/TDD mode or WIMAX OFDMA mode to use this command. Use :INSTrument:SELEct to set the mode.
Couplings	When the Auto Scaling is On, this value is automatically determined by the measurement result. When you set a value manually, Auto Scaling automatically changes to Off.
Preset	10.00 dBm
State Saved	Saved in instrument state.
Min	-250.00 dBm
Max	250.00 dBm
Initial S/W Revision	Prior to A.02.00
Modified at S/W Revision	A.02.00, A.03.00

Range

The Range menu allows setting amplitude controls of the instrument.

Key Path	AMPTD Y Scale
Scope	Meas Global
Initial S/W Revision	A.12.50

Range

Represents the amplitude of the largest sinusoidal signal that could be present within the IF without being clipped by the ADC. For signals with high peak-to-average ratios, the range may need to exceed the rms signal power by a fair amount to avoid clipping.

Key Path	Range
Mode	BASIC
Remote Command	<code>[:SENSe] :POWer [:RF] :RANGe <real></code> <code>[:SENSe] :POWer [:RF] :RANGe?</code>
Example	<code>:POW:RANG 10.0</code> <code>:POW:RANG?</code>
Notes	The MIN and MAX values are affected by the External Gain parameters, and by the Center Frequency. (The hardware compensates for frequency response and alters the Range setting.)
Preset	0
State Saved	Saved in instrument state.
Min	-100
Max	100
Initial S/W Revision	A.12.50

Adjust Range For Min Clip

Sets the combination of attenuation and gain based on the current measured signal level so that clipping will be at a minimum.

This is an "immediate action" function, that is, it executes once, when the key is pressed.

This key is grayed out in measurements that do not support this functionality.

Key Path	AMPTD Y Scale, Attenuation
Remote Command	<code>[:SENSe] :POWer [:RF] :RANGe:OPTimize IMMEDIATE</code>
Initial S/W Revision	Prior to A.02.00
Modified at S/W Revision	A.03.00

Pre-Adjust for Min Clip

If this function is on, it does the adjustment described under Adjust Range For Min Clip each time a measurement restarts. Therefore, in Continuous measurement mode, it only executes before the first measurement.

Key Path	AMPTD Y Scale, Attenuation
----------	----------------------------

Remote Command	<code>[:SENSe] :POWer [:RF] :RANGe :OPTimize :ATTenuation OFF ON ELECtrical COMBined</code> <code>[:SENSe] :POWer [:RF] :RANGe :OPTimize :ATTenuation ?</code>
Notes	This parameter is shared with old XA platform which uses AutoAtten. To keep the backward compatibility, ELECtrical and COMBined still can be used. Then, upon receiving ELECtrical and COMBined, these enums will be interpreted as aliases of ON. Then, when queried, ON will be returned.
Preset	OFF for Swept SA measurement; ON for all other measurements that support Pre-Adjust for Min Clip
State Saved	Saved in instrument state
Initial S/W Revision	Prior to A.02.00
Modified at S/W Revision	A.03.00

Peak to Average

The Peak to Average Ratio is used with the Range setting to optimize the level control in the instrument. The value is the ratio, in dB, of the peak power to the average power of the signal to be measured. A ratio of 0 should be used for sinusoidal signals; for 802.11g OFDM signals use 9 dB.

All Applications (Modes) will show the current value of Peak to Average ratio on the softkey. However, some applications will not permit changing the value. In these situations the softkey will be grayed-out.

Key Path	AMPTD Y Scale, Range
Remote Command	<code>[:SENSe] :POWer [:RF] :RANGe :PARatio <real></code> <code>[:SENSe] :POWer [:RF] :RANGe :PARatio ?</code>
Example	POW:RANG:PAR 12 dB
Notes	In some Applications (Modes) this parameter will be read-only; meaning the value will appear on the softkey and query via SCPI, but not changeable. In such applications the softkey will be grayed-out. Attempting to change the value via SCPI will be ignored and no error message will be generated.
Preset	10 dB
State Saved	Saved in instrument state
Min	0 dB
Max	20 dB
Initial S/W Revision	A.13.00

Mixer Level Offset

Mixer level offset is an advanced setting to adjust target Range at the input mixer which in turn affects the signal level in the instrument's IF. This setting can be used when additional optimization is needed after setting Peak to Average ratio. Positive values of offset optimize noise performance over distortion, negative values optimize distortion performance over noise.

Key Path	AMPTD Y Scale, Range
----------	----------------------

Remote Command	<code>[:SENSe] :POWer [:RF] :RANGe :MIXer :OFFSet <real></code> <code>[:SENSe] :POWer [:RF] :RANGe :MIXer :OFFSet?</code>
Example	<code>POW:RANG:MIX:OFFS -5 dB</code>
Preset	0 dB
State Saved	Saved in instrument state
Min	-35 dB
Max	30 dB
Initial S/W Revision	A.13.00

Scale/Div

Sets the units per division of the vertical scale in the logarithmic display. However, since the Auto Scaling is defaulted to On, this value is automatically determined by the measurement result. When you set a value manually, Auto Scaling automatically changes to Off.

Key Path	AMPTD Y Scale
Mode	SA, WCDMA, C2K, WIMAX OFDMA, 1xEVDO, DVB-T/H, DTMB (CTTB), ISDB-T, CMMB, LTE, LTETDD, Digital Cable TV, WLAN, MSR, LTEAFDD, LTEATDD
Remote Command	<code>:DISPlay:CHPower:VIEW[1]:WINDow[1]:TRACe:Y[:SCALe]:PDIVision <rel_amp1></code> <code>:DISPlay:CHPower:VIEW[1]:WINDow[1]:TRACe:Y[:SCALe]:PDIVision?</code>
Example	<code>DISP:CHP:VIEW:WIND:TRAC:Y:PDIV 2</code> <code>DISP:CHP:VIEW:WIND:TRAC:Y:PDIV?</code>
Notes	You must be in the Spectrum Analysis mode, W-CDMA mode, cdma2000 mode, DVB-T/H mode, DTMB (CTTB) mode, ISDB-T mode, CMMB mode, Digital Cable TV mode, LTE mode, LTE TDD mode, WLAN mode, 1xEVDO mode, MSR, LTE-Advanced FDD/TDD mode or WIMAX OFDMA mode to use this command. Use <code>:INSTrument:SElect</code> to set the mode.
Couplings	When the Auto Scaling is On, this value is automatically determined by the measurement result. When you set a value manually, Auto Scaling automatically changes to Off.
Preset	10.00 dB
State Saved	Saved in instrument state.
Min	0.10 dB
Max	20.00 dB
Initial S/W Revision	Prior to A.02.00
Modified at S/W Revision	A.02.00, A.03.00

Ref Position

Positions the reference level at the top, center, or bottom of the Y Scale display. Changing the reference position does not change the reference level value.

Key Path	AMPTD Y Scale
Mode	SA, WCDMA, C2K, WIMAX OFDMA, 1xEVDO, DVB-T/H, DTMB (CTTB), ISDB-T, CMMB, LTE, LTE-TDD, Digital Cable TV, WLAN, MSR, LTEAFDD, LTEATDD
Remote Command	:DISPlay:CHPower:VIEW[1]:WINDow[1]:TRACe:Y[:SCALe]:RPOSition TOP CENTER BOTTom :DISPlay:CHPower:VIEW[1]:WINDow[1]:TRACe:Y[:SCALe]:RPOSition?
Example	DISP:CHP:VIEW:WIND:TRAC:Y:RPOS CENT DISP:CHP:VIEW:WIND:TRAC:Y:RPOS?
Notes	You must be in the Spectrum Analysis mode, W-CDMA mode, cdma2000 mode, DVB-T/H mode, DTMB (CTTB) mode, ISDB-T mode, CMMB mode, Digital Cable TV mode, LTE mode, LTE TDD mode, WLAN mode, 1xEVDO mode, MSR, LTE-Advanced FDD/TDD mode or WIMAX OFDMA mode to use this command. Use :INSTRument:SElect to set the mode.
Preset	TOP
State Saved	Saved in instrument state.
Range	Top Ctr Bot
Initial S/W Revision	Prior to A.02.00
Modified at S/W Revision	A.02.00, A.03.00

Auto Scaling

Toggles the Auto Scaling function between On and Off.

Key Path	AMPTD Y Scale
Mode	SA, WCDMA, C2K, WIMAX OFDMA, 1xEVDO, DVB-T/H, DTMB (CTTB), ISDB-T, CMMB, LTE, LTE-TDD, Digital Cable TV, WLAN, MSR, LTEAFDD, LTEATDD
Remote Command	:DISPlay:CHPower:VIEW[1]:WINDow[1]:TRACe:Y[:SCALe]:COUPle 0 1 OFF ON :DISPlay:CHPower:VIEW[1]:WINDow[1]:TRACe:Y[:SCALe]:COUPle?
Example	DISP:CHP:VIEW:WIND:TRAC:Y:COUP OFF DISP:CHP:VIEW:WIND:TRAC:Y:COUP?
Couplings	When Auto Scaling is On, and the Restart front-panel key is pressed, this function automatically sets the scale per division to 10 dB and determines the reference values based on the measurement results. When you set a value to either Scale/Div or Ref Value manually, Auto Scaling automatically changes to Off.
Preset	1
State Saved	Saved in instrument state.
Range	On Off
Initial S/W Revision	Prior to A.02.00
Modified at S/W Revision	A.02.00, A.03.00

Auto Couple

The Auto Couple feature provides a quick and convenient way to automatically couple multiple instrument settings. This helps ensure accurate measurements and optimum dynamic range. When the Auto Couple feature is activated, either from the front panel or remotely, all parameters of the current measurement that have an Auto/Manual mode are set to Auto mode and all measurement settings dependent on (or coupled to) the Auto/Man parameters are automatically adjusted for optimal performance.

However, the Auto Couple key actions are confined to the current measurement only. It does not affect other measurements in the mode, and it does not affect markers, marker functions, or trace or display attributes.

See "[More Information](#)" on page 292

Key Path	Front-panel key
Remote Command	:COUPle ALL NONE
Example	:COUP ALL
Notes	:COUPle ALL puts all Auto/Man parameters in Auto mode (equivalent to pressing the Auto Couple key). :COUPLE NONE puts all Auto/Man parameters in manual mode. It decouples all the coupled instrument parameters and is not recommended for making measurements.
Initial S/W Revision	Prior to A.02.00

More Information

There are two types of functions that have Auto/Manual modes.

Auto/Man Active Function keys

An Auto/Man toggle key controls the binary state associated with an instrument parameter by toggling between Auto (where the parameter is automatically coupled to the other parameters it is dependent upon) and Man (where the parameter is controlled independent of the other parameters), as well as making the parameter the active function. The current mode is indicated on the softkey with either Auto or Man underlined as illustrated below.

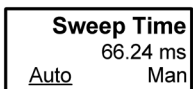

vsd07

Auto/Man 1-of-N keys

An Auto/Man 1-of-N key allows you to manually pick from a list of parameter values, or place the function in Auto, in which case the value is automatically selected (and indicated) as shown below. If in Auto, Auto is underlined on the calling key. If in manual operation, manual is indicated on the calling key. But the calling key does not actually toggle the function, it simply opens the menu.

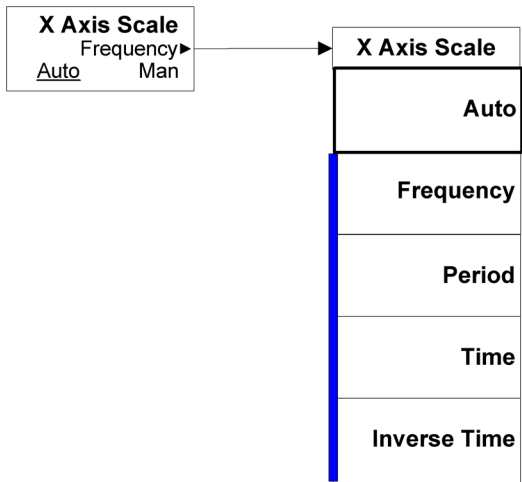

vsd08

BW

Accesses a menu of functions that enable you to specify and control the video and resolution bandwidths. You can also select the type of filter for the measurement and set the filter bandwidth.

Key Path	Front-panel key
Initial S/W Revision	Prior to A.02.00

Res BW

Sets the value of the resolution bandwidth (RBW). If an unavailable bandwidth is entered with the numeric keypad, the closest available bandwidth is selected.

LTE-Advanced FDD/TDD Auto RBW:

Bandwidth	RBW (KHz)
1.4MHz	20
3MHz	43
5MHz	68
10MHz	150
15MHz	220
20MHz	270

the resolution bandwidth is predefined based on the corresponding bandwidth of the single LTE carrier, which is listed above. When ResBW mode is Auto, the narrowest RBW over the active carriers is selected for Multi-carriers.

Key Path	BW
Mode	SA, WCDMA, C2K, WIMAX OFDMA, 1xEVDO, DVB-T/H, DTMB (CTTB), ISDB-T, CMMB, LTE, LTETDD, Digital Cable TV, WLAN, MSR, LTEAFDD, LTEATDD
Remote Command	[:SENSe]:CHPower:BANDwidth[:RESolution] <bandwidth> [:SENSe]:CHPower:BANDwidth[:RESolution]? [:SENSe]:CHPower:BANDwidth[:RESolution]:AUTO ON OFF 1 0 [:SENSe]:CHPower:BANDwidth[:RESolution]:AUTO?
Example	CHP:BAND 5 MHz CHP:BAND? CHP:BAND:AUTO ON CHP:BAND:AUTO?
Notes	You must be in the Spectrum Analysis mode, W-CDMA mode, cdma2000 mode, DVB-T/H mode, DTMB (CTTB) mode, ISDB-T mode, CMMB mode, Digital Cable TV mode, LTE mode, LTE TDD mode, WLAN mode, 1xEVDO mode, MSR, LTE-Advanced FDD/TDD mode or WIMAX OFDMA mode to use this command. Use :INSTrument:SElect to set the mode.

Couplings	<p>Sweep time is coupled to the RBW. As the RBW changes, the sweep time (if set to Auto) is changed to maintain amplitude calibration.</p> <p>Video bandwidth (VBW) is coupled to the RBW. As the resolution bandwidth changes, the video bandwidth (if set to Auto) changes to maintain the ratio of VBW/RBW (10:1).</p> <p>When the Res BW is set to Auto, the resolution bandwidth is auto-coupled to the span. The ratio of Span/RBW is approximately 106:1 when auto coupled. When Res BW is set to Man, and the bandwidths are entered manually, these bandwidths are used regardless of other analyzer settings.</p>
Preset	<p>SA: Auto</p> <p>WCDMA: 240 kHz</p> <p>C2K: 24 kHz</p> <p>WIMAX OFDMA: 100kHz</p> <p>1xEVDO: 30kHz</p> <p>DVB-T/H: 3.9kHz</p> <p>DTMB (CTTB): 3.9kHz</p> <p>ISDB-T: 30kHz</p> <p>CMMB: 3.9kHz</p> <p>LTE: Auto</p> <p>LTETDD: Auto</p> <p>Digital Cable TV: 3.9kHz</p> <p>WLAN: 100 kHz</p> <p>MSR: 100kHz</p> <p>LTEAFDD/LTEATDD: Auto</p> <p>WCDMA, C2K, 1xEVDO , WIMAX OFDMA, DVB-T/H, DTMB (CTTB), ISDB-T, CMMB, Digital Cable TV, WLAN, MSR: OFF</p> <p>SA, LTE, LTETDD, LTEAFDD, LTEATDD: ON</p>
State Saved	Saved in instrument state.
Min	1 Hz
Max	8 MHz
Backwards Compatibility SCPI	[:SENSe] :CHPower :BWIDth [:RESolution]
Initial S/W Revision	Prior to A.02.00
Modified at S/W Revision	A.02.00, A.03.00

Video BW

Changes the analyzer post-detection filter (VBW).

Key Path	BW
Mode	SA, WCDMA, C2K, WIMAX OFDMA, 1xEVDO, DVB-T/H, DTMB (CTTB), ISDB-T, CMMB, LTE, LTETDD, Digital Cable TV, WLAN, MSR, LTEAFDD, LTEATDD
Remote Command	[:SENSe] :CHPower :BANDwidth :VIDeo <bandwidth>

	<pre>[:SENSe] :CHPower:BAWdwidth:VIDeo?</pre> <pre>[:SENSe] :CHPower:BAWdwidth:VIDeo:AUTO ON OFF 1 0</pre> <pre>[:SENSe] :CHPower:BAWdwidth:VIDeo:AUTO?</pre>
Example	<pre>CHP:BAWd:VID 2.4 MHz</pre> <pre>CHP:BAWd:VID?</pre> <pre>CHP:BAWd:VID:AUTO OFF</pre> <pre>CHP:BAWd:VID:AUTO?</pre>
Notes	<p>You must be in the Spectrum Analysis mode, W-CDMA mode, cdma2000 mode, DVB-T/H mode, DTMB (CTTB) mode, ISDB-T mode, CMMB mode, Digital Cable TV mode, LTE mode, LTE TDD mode, WLAN mode, 1xEVDO mode, MSR,LTE-Advanced FDD/TDD mode or WIMAX OFDMA mode to use this command. Use :INSTrument:SElect to set the mode.</p>
Dependencies	See Couplings
Couplings	<p>Video bandwidth (VBW) is coupled to the RBW. As the resolution bandwidth changes, the video bandwidth (if set to Auto) changes to maintain the ratio set by VBW/RBW.</p> <p>Sweep Time is coupled to the Video Bandwidth (VBW). As the VBW is changed, the sweep time (when set to Auto) is changed to maintain amplitude calibration. This occurs because of common hardware between the two circuits, even though the Video BW filter is not actually “in-circuit” when the detector is set to Average. Because the purpose of the average detector and the VBW filter are the same, either can be used to reduce the variance of the result.</p> <p>Although the VBW filter is not “in-circuit” when using the average detector, the Video BW key can have an effect on (Auto) sweep time, and is not disabled. In this case, reducing the VBW setting increases the sweep time, which increases the averaging time, producing a lower-variance trace.</p> <p>When using the average detector with either Sweep Time set to Man, or in zero span, the VBW setting has no effect and is disabled (grayed out).</p> <p>When the video bandwidth is AUTO coupled, the video bandwidth value is set to: Resolution Bandwidth * Video Bandwidth to Resolution Bandwidth Ratio</p>
Preset	<pre>SA: Auto</pre> <pre>WCDMA: 2.4MHz</pre> <pre>C2K: 240 kHz</pre> <pre>WIMAX OFDMA: Auto</pre> <pre>1xEVDO: 300 kHz</pre> <pre>DVB-T/H: 39kHz</pre> <pre>DTMB (CTTB): 39kHz</pre> <pre>ISDB-T: 300kHz</pre> <pre>CMMB: 39kHz</pre> <pre>LTE, MSR: Auto</pre> <pre>LTETDD: Auto</pre> <pre>LTEAFDD,LTEATDD:Auto</pre> <pre>Digital Cable TV: 39kHz</pre> <pre>WLAN: Auto</pre> <pre>ON</pre>

State Saved	Saved in instrument state.
Min	1 Hz
Max	50 MHz
Initial S/W Revision	Prior to A.02.00
Modified at S/W Revision	A.02.00, A.03.00

Filter Type

Selects the type of bandwidth filter that is used. The choices are Gaussian or Flat top.

Key Path	BW
Mode	SA, WCDMA, C2K, WIMAX OFDMA, 1xEVDO, DVB-T/H, DTMB (CTTB), ISDB-T, CMMB, LTE, LTE-TDD, Digital Cable TV, WLAN, MSR, LTEAFDD, LTEATDD
Remote Command	[:SENSe] :CHPower :BANDwidth :SHAPE GAUSSian FLATtop [:SENSe] :CHPower :BANDwidth :SHAPE?
Example	CHP:BAND:SHAP GAUS CHP:BAND:SHAP?
Preset	GAUSSian
State Saved	Saved in instrument state.
Range	Gaussian Flattop
Backwards Compatibility SCPI	[:SENSe] :CHPower :BWIDth :SHAPE
Initial S/W Revision	Prior to A.02.00
Modified at S/W Revision	A.02.00, A.03.00

Cont (Continuous Measurement/Sweep)

Sets the analyzer for Continuous measurement operation. The single/continuous state is Meas Global so the setting will affect all measurements. If you are Paused, pressing Cont does a Resume.

Key Path	Front-panel key
Remote Command	:INITiate:CONTinuous OFF ON 0 1 :INITiate:CONTinuous?
Example	:INIT:CONT 0 puts analyzer in Single measurement operation. :INIT:CONT 1 puts analyzer in Continuous measurement operation
Preset	ON (Note that SYST:PRESet sets INIT:CONT to ON but *RST sets INIT:CONT to OFF)
State Saved	Saved in instrument state
Backwards Compatibility Notes	For Spectrum Analysis mode in ESA and PSA, there is no Cont hardkey, instead there is a Sweep Single/Cont key. In these analyzers, switching the Sweep Single/Cont key from Single to Cont restarts averages (displayed average count reset to 1), but does not restart Max Hold and Min Hold. The X-Series has Single and Cont keys in place of the SweepSingleCont key. In the X-Series, if in single measurement, the Cont key (and INIT:CONT ON) switches to continuous measurement, but never restarts a measurement and never resets a sweep.
Initial S/W Revision	Prior to A.02.00

In Swept SA Measurement (Spectrum Analysis Mode):

The analyzer takes repetitive sweeps, averages, measurements, etc., when in Continuous mode. When the average count reaches the Average/Hold Number the count stops incrementing, but the analyzer keeps sweeping. See the Trace/Detector section for the averaging formula used both before and after the Average/Hold Number is reached. The trigger condition must be met prior to each sweep. The type of trace processing for multiple sweeps, is set under the Trace/Detector key, with choices of Trace Average, Max Hold, or Min Hold.

In Other Measurements/Modes:

With Avg/Hold Num (in the Meas Setup menu) set to Off or set to On with a value of 1, a sweep is taken after the trigger condition is met; and the analyzer continues to take new sweeps after the current sweep has completed and the trigger condition is again met. However, with Avg/Hold Num set to On with a value >1, multiple sweeps (data acquisitions) are taken for the measurement. The trigger condition must be met prior to each sweep. The sweep is not stopped when the average count k equals the number N set for Avg/Hold Num is reached, but the number k stops incrementing. A measurement average usually applies to all traces, marker results, and numeric results. But sometimes it only applies to the numeric results.

If the analyzer is in Single measurement, pressing the Cont key does not change k and does not cause the sweep to be reset; the only action is to put the analyzer into Continuous measurement operation.

If it is already in continuous sweep:

the INIT:CONT 1 command has no effect

the INIT:CONT 0 command will place the analyzer in Single Sweep but will have no effect on the current sequence until $k = N$, at which point the current sequence will stop and the instrument will go to the idle state.

8 Channel Power Measurement
File

File

See "File" on page 184

FREQ Channel

Accesses a menu of keys that allow you to control the Frequency and Channel parameters of the instrument.

Some features in the Frequency menu are the same for all measurements – they do not change as you change measurements. Settings like these are called “Meas Global” and are unaffected by Meas Preset. For example, the Center Freq setting is the same for all measurements – it does not change as you change measurements.

Key Path	Front-panel key
Initial S/W Revision	Prior to A.02.00

Center Freq

Sets the frequency that corresponds to the horizontal center of the graticule (when frequency Scale Type is set to linear). While adjusting the Center Frequency the Span is held constant, which means that both Start Frequency and Stop Frequency will change.

Pressing Center Freq also sets the frequency entry mode to Center/Span. In Center/Span mode, the center frequency and span values are displayed below the graticule, and the default active function in the Frequency menu is Center Freq.

The center frequency setting is the same for all measurements within a mode, that is, it is Meas Global. Some modes are also able to share a Mode Global center frequency value. If this is the case, the Mode will have a Global Settings key in its Mode Setup menu.

The Center Freq function sets (and queries) the Center Frequency for the currently selected input. If your analyzer has multiple inputs, and you select another input, the Center Freq changes to the value for that input. SCPI commands are available to directly set the Center Freq for a specific input.

Center Freq is remembered as you go from input to input. Thus you can set a Center Freq of 10 GHz with the RF Input selected, change to BBIQ and set a Center Freq of 20 MHz, then switch to External Mixing and set a Center Freq of 60 GHz, and when you go back to the RF Input the Center Freq will go back to 10 GHz; back to BBIQ and it is 20 MHz; back to External Mixing and it is 60 GHz.

See ["RF Center Freq" on page 304](#)

See [Ext Mix Center Freq](#)

See ["I/Q Center Freq" on page 306](#)

See ["Center Frequency Presets" on page 302](#)

Key Path	FREQ Channel
Scope	Meas Global
Remote Command	[:SENSe] :FREQuency:CENTer <freq> [:SENSe] :FREQuency:CENTer?
Example	FREQ:CENT 50 MHz

	FREQ:CENT UP changes the center frequency to 150 MHz if you use FREQ:CENT:STEP 100 MHz to set the center frequency step size to 100 MHz FREQ:CENT?
Notes	This command sets either the RF or I/Q Center Frequency depending on the selected input. For RF input it is equivalent to FREQ:RF:CENT For I/Q input it is equivalent to FREQ:IQ:CENT Preset and Max values are dependent on Hardware Options (5xx) If no terminator (e.g. MHz) is sent the terminator Hz is used. If a terminator with unit other than Frequency is used, an invalid suffix error message is generated.
Dependencies	The Center Frequency can be limited by Start or Stop Freq limits, if the Span is so large that Start or Stop reach their limit.
Couplings	When operating in "swept span", any value of the Center Frequency or Span that is within the frequency range of the analyzer is allowed when the value is being set through the front panel numeric key pad or the SCPI command. The other parameter is forced to a different value if needed, to keep the Start and the Stop Frequencies within the analyzer's frequency range
Preset	Depends on instrument maximum frequency, mode, measurement, and selected input. See " Center Frequency Presets " on page 302 and " RF Center Freq " on page 304 and Ext Mix Center Freq and " I/Q Center Freq " on page 306.
State Saved	Saved in instrument state
Min	Depends on instrument maximum frequency, mode, measurement, and selected input.. See " Center Frequency Presets " on page 302 and " RF Center Freq " on page 304 and " I/Q Center Freq " on page 306.
Max	Depends on instrument maximum frequency, mode, measurement, and selected input.. See " Center Frequency Presets " on page 302 and " RF Center Freq " on page 304 and " I/Q Center Freq " on page 306.
Default Unit	Hz
Status Bits/OPC	Non-overlapped
Dependencies	
Initial S/W Revision	Prior to A.02.00

Center Frequency Presets

The following table provides the Center Frequency Presets for the Spectrum Analyzer mode, and the Max Freq, for the various frequency options:

Freq Option	CF after Mode Preset	Stop Freq after Mode Preset	Max Freq (can't tune above)

503 (all but N9000A)	1.805 GHz	3.6 GHz	3.7 GHz
503 (N9000A)	1.505 GHz	3.0 GHz	3.08 GHz
504 (M9420A)	1 GHz	3.8GHz	3.88 GHz
506 (M9420A)	1 GHz	6.0GHz	6.08 GHz
507 (all but N9000A)	3.505 GHz	7.0 GHz	7.1 GHz
507 (N9000A)	3.755 GHz	7.5 GHz	7.58 GHz
508 (all but N9038A)	1.805 GHz	3.6 GHz	8.5 GHz
508 (N9038A)	4.205 GHz	8.4 GHz	8.5 GHz
513	6.805 GHz	13.6 GHz	13.8 GHz
526 (all but N9000A and N9038A)	13.255 GHz	26.5 GHz	27.0 GHz
526 (N9000A)	13.255 GHz	26.5 GHz	26.55 GHz
526 (N9038A)	1.805 GHz	3.6 GHz	27.0 GHz
532	16.005 GHz	32.0 GHz	32.5 GHz
543	21.505 GHz	43.0 GHz	TBD
544	22.005 GHz	44.0 GHz	44.5 GHz
550	25.005 GHz	50.0 GHz	51 GHz

Input 2:

Model	CF after Mode Preset	Stop Freq after Mode Preset	Max Freq (can't tune above)
N9000A opt C75	0.7505GHz	1.5 GHz	1.58 GHz
N9038A	505 MHz	1 GHz	1.000025 GHz

Tracking Generator Frequency Limits (N9000A only):

Tracking Generator Option	Min Freq (clips to this freq when turn TG on and can't tune below while TG on)	If above this Freq, Stop Freq clipped to this Freq when TG turned on	Max Freq (can't tune above) while TG on
T03	9 kHz	3.0 GHz	3.08 GHz
T06	9 kHz	6.0 GHz	6.05 GHz

The following table shows the Center Frequency Presets for modes other than Spectrum Analyzer:

Mode	CF Preset for RF
WCDMA	1 GHz
WIMAXOFDMA,	1 GHz
BASIC	1 GHz
ADEMOD	1 GHz
VSA	1 GHz
TDSCDMA	1 GHz
PNOISE	1 GHz
LTE	1 GHz
LTETDD	1 GHz
MSR	1 GHz
GSM	935.2 MHz
NFIGURE	1.505 GHz

RF Center Freq

SCPI command for specifying the RF Center Frequency. This command will set the Center Frequency to be used when the RF input is selected, even if the RF input is not the input that is selected at the time the command is sent. Note that the Center Freq function in the Frequency menu on the front panel always applies to the currently selected input.

Scope	Meas Global
Remote Command	<code>[:SENSe] :FREQuency:RF:CENTer <freq></code> <code>[:SENSe] :FREQuency:RF:CENTer?</code>
Example	FREQ:RF:CENT 30 MHz
Notes	This command is the same in all modes, but the parameter is Measurement Global. So the value is independent in each mode and common across all the measurements in the mode.
Dependencies	If the electronic/soft attenuator is enabled, any attempt to set Center Frequency such that the Stop Frequency would be >3.6 GHz fails and results in an advisory message. If the equivalent SCPI

	command is sent, this same message is generated as part of a “-221, Settings conflict” warning. If Source Mode is set to Tracking, and the Max or Min Center Freq is therefore limited by the limits of the source, a warning message is generated, “Data out of range;clipped to source max/min” if these limits are exceeded. Note that for an external source, these limits can be affected by the settings of Source Numerator, Source Denominator and Power Sweep.
Preset	See table above
State Saved	Saved in instrument state.
Min	-79.999995 MHz, unless Source Mode is set to Tracking, in which case it is limited by the minimum frequency of the Source
Max	See table above. Basically instrument maximum frequency - 5 Hz. Note that, if the Source Mode is set to Tracking, the effective instrument maximum frequency may be limited by the source maximum frequency. If the knob or step keys are being used, also depends on the value of the other three interdependent parameters Span, Start Frequency and Stop Frequency
Initial S/W Revision	Prior to A.02.00
Modified at S/W Revision	A.03.00

Ext Mix Center Freq

SCPI command for specifying the External Mixer Center Frequency. This command will set the Center Frequency to be used when the External Mixer is selected, even if the External Mixer input is not the input which is selected at the time the command is sent. Note that the Center Freq function in the Frequency menu on the front panel always applies to the currently selected input.

Scope	Meas Global
Remote Command	<code>[:SENSe] :FREQuency:EMIXer:CENTer <freq></code> <code>[:SENSe] :FREQuency:EMIXer:CENTer?</code>
Example	<code>:FREQ:EMIX:CENT 60 GHz</code> <code>:FREQ:EMIX:CENT?</code>
Notes	This command is the same in all modes, but the parameter is Measurement Global. So the value is independent in each mode and common across all the measurements in the mode.
Couplings	When returning to External Mixing after having been switched to one of the other inputs (e.g., RF), you will come back into the settings that you had when you left External Mixing. So you will come back to the band you were in with the Center Frequency that you had. However, Span is not an input-dependent parameter, therefore you will bring the span over from the other input. Therefore, the analyzer comes back with the span from the previous input, limited as necessary by the current mixer setup.
Preset	When a Mode Preset is performed while in External Mixing, the Start frequency of the current Mode is set to the nominal Min Freq of the lowest harmonic range in the Harmonic Table for the current mixer setup. Similarly, the Stop frequency of the current Mode is set to the nominal Max Freq of the highest harmonic range in the Harmonic Table. The Center Freq thus presets to the point arithmetically equidistant from these two frequencies.

	<p>If the current measurement has a limited Span available to it, and cannot achieve the Span shown in the table (Span=Stop Freq – Start Freq), the analyzer uses the maximum Span the measurement allows, and still sets the Center Freq to the midpoint of the Start and Stop Freq values in the Harmonic Table.</p> <p>When Restore Input/Output Defaults is performed, the mixer presets to the 11970A, whose Start and Stop frequencies are 26.5 and 40 GHz respectively. The center of these two frequencies is 33.25 GHz.</p> <p>Therefore, after a Restore Input/Output Defaults, if you go into External Mixing and do a Mode Preset while in the Spectrum Analyzer Mode, the resulting Center Freq is 33.25 GHz.</p>
State Saved	Saved in instrument state.
Min	The minimum frequency in the currently selected mixer band + 5 Hz
Max	The maximum frequency in the currently selected mixer band – 5 Hz If the knob or step keys are being used, also depends on the value of the other three interdependent parameters Span, Start Frequency and Stop Frequency
Initial S/W Revision	A.08.01

I/Q Center Freq

SCPI command for specifying the I/Q Center Frequency. This command will set the Center Frequency to be used when the I/Q input is selected, even if the I/Q input is not the input which is selected at the time the command is sent. Note that the Center Freq function in the Frequency menu on the front panel always applies to the currently selected input.

Scope	Meas Global
Remote Command	[:SENSe] :FREQuency:IQ:CENTer <freq> [:SENSe] :FREQuency:IQ:CENTer?
Example	FREQ:IQ:CENT: 30 MHz
Notes	This command is the same in all modes, but the parameter is Measurement Global. So the value is independent in each mode and common across all the measurements in the mode.
Preset	0 Hz
State Saved	Saved in instrument state.
Min	-40.049995 MHz
Max	40.049995 MHz
Initial S/W Revision	Prior to A.02.00

CF Step

Changes the step size for the center frequency and start and stop frequency functions. Once a step size has been selected and the center frequency function is active, the step keys (and the UP|DOWN parameters for Center Frequency from remote commands) change the center frequency by the step-size value. The step size function is useful for finding harmonics and sidebands beyond the current frequency span of the analyzer.

Note that the start and stop frequencies also step by the CF Step value.

Key Path	FREQ Channel
Remote Command	[:SENSe]:FREQuency:CENTer:STEP[:INCRement] <freq> [:SENSe]:FREQuency:CENTer:STEP[:INCRement]? [:SENSe]:FREQuency:CENTer:STEP:AUTO OFF ON 0 1 [:SENSe]:FREQuency:CENTer:STEP:AUTO?
Example	FREQ:CENT:STEP:AUTO ON FREQ:CENT:STEP 500 MHz FREQ:CENT UP increases the current center frequency value by 500 MHz FREQ:CENT:STEP? FREQ:CENT:STEP:AUTO?
Notes	Preset and Max values are depending on Hardware Options (503, 507, 508, 513, 526)
Notes	Preset and Max values are dependent on Hardware Options (5xx)
Dependencies	Freq Offset is not available in External Mixing. In this case the Freq Offset key is grayed out and shows a value of zero. It will once again be available, and show the previously set value, when you return to the RF Input.
Dependencies	Span, RBW, Center frequency If the electronic/soft attenuator is enabled, any attempt to change the value of the center frequency >3.6 GHz by pressing the Up-arrow key, fails and results in an advisory message. If the equivalent SCPI command is sent, this same message is generated as part of a “-221, Settings conflict” warning.
Couplings	When auto-coupled in a non-zero span, the center frequency step size is set to 10% of the span. When auto-coupled in zero span, the center frequency step size is set to the equivalent -3 dB RBW value.
Preset	Auto ADEMOD: 1 MHz ON
State Saved	Saved in instrument state
Min	– (the maximum frequency of the instrument). That is, 27 GHz max freq instrument has a CF step range of +/- 27 GHz. Note that this is the maximum frequency given the current settings of the instrument, so in External Mixing, for example, it is the maximum frequency of the current mixer band.
Max	The maximum frequency of the instrument. That is, 27 GHz max freq instrument has a CF step range of +/- 27 GHz. Note that this is the maximum frequency given the current settings of the instrument, so in External Mixing, for example, it is the maximum frequency of the current mixer band.
Default Unit	Hz
Status Bits/OPC dependencies	non-overlapped
Initial S/W Revision	Prior to A.02.00
Modified at S/W Revision	A.03.00

Input/Output

See ["Input/Output" on page 138](#)

Marker

Accesses a menu that enables you to select, set up and control the markers for the current measurement.

Key Path	Front-panel key
Initial S/W Revision	Prior to A.02.00

Select Marker

Displays 12 markers available for selection.

Key Path	Marker
Initial S/W Revision	Prior to A.02.00

Marker Type

Sets the marker control mode to Normal, Delta, Fixed or Off. All interactions and dependencies detailed under the key description are enforced when the remote command is sent. If the selected marker is Off, pressing Marker sets it to Normal and places it at the center of the screen on the trace determined by the Marker Trace rules. At the same time, Marker X Axis Value appears on the Active Function area.

The default active function is the active function for the currently selected marker control mode. If the current control mode is Off, there is no active function and the active function is turned off.

Key Path	Marker
Mode	SA, WCDMA, C2K, WIMAX OFDMA, 1xEVDO, DVB-T/H, DTMB (CTTB), ISDB-T, CMMB, LTE, LTETDD, Digital Cable TV, WLAN, MSR, LTEAFDD, LTEATDD
Remote Command	:CALCulate:CHPower:MARKer[1] 2 ... 12:MODE POSITION DELTa OFF :CALCulate:CHPower:MARKer[1] 2 ... 12:MODE?
Example	CALC:CHP:MARK3:MODE POS CALC:CHP:MARK3:MODE?
Notes	If the selected marker is Off, pressing Marker sets it to Normal and places it at the center of the screen on the trace determined by the Marker Trace rules. At the same time, Marker X Axis Value appears on the Active Function area. Default Active Function: the active function for the selected marker's current control mode. If the current control mode is Off, there is no active function and the active function is turned off. Active Function Display: the marker X axis value entered in the active function area displays the marker value to its full entered precision.
Preset	OFF
State Saved	Saved in instrument state.
Range	Normal Delta Off

Initial S/W Revision	Prior to A.02.00
Modified at S/W Revision	A.02.00, A.03.00

Properties

Accesses the marker properties menu.

Key Path	Marker
Initial S/W Revision	Prior to A.02.00

Select Marker

Displays 12 markers available for selection.

Key Path	Marker
Initial S/W Revision	Prior to A.02.00

Relative To

Sets the reference marker to which the selected marker is relative.

Key Path	Marker, Properties
Mode	SA, WCDMA, C2K, WIMAX OFDMA, 1xEVDO, DVB-T/H, DTMB (CTTB), ISDB-T, CMMB, LTE, LTETDD, Digital Cable TV, WLAN, MSR, LTEAFDD, LTEATDD
Remote Command	:CALCulate:CHPower:MARKer[1] 2 ... 12:REference <integer> :CALCulate:CHPower:MARKer[1] 2 ... 12:REference?
Example	CALC:CHP:MARK:REF 5 CALC:CHP:MARK:REF?
Notes	A marker cannot be relative to itself so that choice is grayed out, and if sent from SCPI generates error -221: "Settings conflict; marker cannot be relative to itself." When queried, a single value is returned (the specified marker numbers relative marker). You must be in the Spectrum Analysis or WCDMA mode to use this command. Use :INSTrument:SElect to set the mode.
Preset	2 3 4 5 6 7 8 9 10 11 12 1
State Saved	Saved in instrument state.
Min	1
Max	12
Initial S/W Revision	Prior to A.02.00
Modified at S/W Revision	A.02.00, A.03.00

All Markers Off

Turns off all markers.

Key Path	Marker
Mode	SA, WCDMA, C2K, WIMAX OFDMA, 1xEVDO, DVB-T/H, DTMB (CTTB), ISDB-T, CMMB, LTE, LTETDD, Digital Cable TV, WLAN, MSR, LTEAFDD, LTEATDD
Remote Command	:CALCulate:CHPower:MARKer:AOFF
Example	CALC:CHP:MARK:AOFF
Initial S/W Revision	Prior to A.02.00
Modified at S/W Revision	A.02.00, A.03.00

Marker X Axis Value (Remote Command Only)

Sets the marker X Axis value in the current marker X Axis Scale unit. It has no effect if the control mode is Off, but is the SCPI equivalent of entering an X value if the control mode is Normal, Delta, or Fixed.

Mode	SA, WCDMA, CDMA2K, WIMAXOFDMA, CDMA1XEV, DVB, DTMB, ISDBT, CMMB, LTE, LTETDD, DCATV, WLAN, MSR, LTEAFDD, LTEATDD
Remote Command	:CALCulate:CHPower:MARKer[1] 2 ... 12:X <real> :CALCulate:CHPower:MARKer[1] 2 ... 12:X?
Example	CALC:CHP:MARK3:X 0 CALC:CHP:MARK3:X?
Notes	The query returns the marker's absolute X Axis value if the control mode is Normal, or the offset from the marker's reference marker if the control mode is Delta. The query is returned in the fundamental units for the current marker X Axis scale: Hz for Frequency.
Preset	After a preset, all markers are turned OFF, so Marker X Axis Value query returns a not a number (NAN).
State Saved	Saved in instrument state.
Min	-9.9E+37
Max	9.9E+37
Initial S/W Revision	Prior to A.02.00
Modified at S/W Revision	A.02.00, A.03.00

Marker X Axis Position (Remote Command Only)

Sets the marker X Axis Scale position in trace points. This setting has no effect if the control mode is Off, but is the SCPI equivalent of entering a value if the control mode is Normal or Delta . The entered value is immediately translated into the current X Axis Scale units for setting the value of the marker.

Mode	SA, WCDMA, CDMA2K, WIMAXOFDMA, CDMA1XEV, DVB, DTMB, ISDBT, CMMB, LTE, LTETDD, DCATV, WLAN, MSR, LTEAFDD, LTEATDD
------	--

Remote Command	:CALCulate:CHPower:MARKer[1] 2 ... 12:X:POStion <real> :CALCulate:CHPower:MARKer[1] 2 ... 12:X:POStion?
Example	CALC:CHP:MARK10:X:POS 0 CALC:CHP:MARK10:X:POS?
Notes	The query returns the marker's absolute X Axis value in trace points if the control mode is Normal, or the offset from the marker's reference marker in trace points if the control mode is Delta.
Preset	After a preset, all markers are turned OFF, so Marker X Axis Value query returns a not a number (NAN).
State Saved	Saved in instrument state.
Min	-9.9E+37
Max	9.9E+37
Initial S/W Revision	Prior to A.02.00
Modified at S/W Revision	A.02.00, A.03.00

Marker Y Axis Value (Remote Command only)

Returns the marker Y Axis value in the current marker Y Axis unit.

Mode	SA, WCDMA, CDMA2K, WIMAXOFDMA, CDMA1XEV, DVB, DTMB, ISDBT, CMMB, LTE, LTETDD, DCATV, WLAN, MSR, LTEAFDD, LTEATDD
Remote Command	:CALCulate:CHPower:MARKer[1] 2 ... 12:Y?
Example	CALC:CHP:MARK11:Y?
Preset	Result dependent on Markers setup and signal source.
State Saved	Saved in instrument state.
Initial S/W Revision	Prior to A.02.00
Modified at S/W Revision	A.02.00, A.03.00

Backward Compatibility SCPI Commands

Sets or queries the state of a marker. Setting a marker which is OFF to state ON or 1 puts it in Normal mode and places it at the center of the screen.

Mode	SA, WCDMA, CDMA2K, WIMAXOFDMA, CDMA1XEV, DVB, DTMB, ISDBT, CMMB, LTE, LTETDD, DCATV, WLAN, MSR, LTEAFDD, LTEATDD
Remote Command	:CALCulate:CHPower:MARKer[1] 2 ... 12:STATe OFF ON 0 1 :CALCulate:CHPower:MARKer[1] 2 ... 12:STATe?
Example	CALC:CHP:MARK3:STAT ON CALC:CHP:MARK3:STAT?
Preset	OFF

8 Channel Power Measurement
Marker

State Saved	Saved in instrument state.
Range	On Off
Initial S/W Revision	Prior to A.02.00
Modified at S/W Revision	A.02.00, A.03.00

Marker Function

There are no 'Marker Functions' supported in Channel Power, so this front-panel key displays a blank menu when pressed.

Key Path	Front-panel key
Initial S/W Revision	Prior to A.02.00

Marker To

There is no 'Marker To' functionality supported in Channel Power measurement, so this front-panel key displays a blank key menu when pressed.

Key Path	Front-panel key
Initial S/W Revision	Prior to A.02.00

Meas

The information in this section is common to all measurements. For key and remote command information for a specific measurement, refer to the section that describes the measurement of interest.

Measurements available under the Meas key are specific to the current Mode.

When viewing Help for measurements, note the following:

NOTE

Operation for some keys differs between measurements. The information displayed in Help pertains to the current measurement. To see how a key operates in a different measurement, exit Help (press the Cancel Esc key), select the measurement, then reenter Help (press the Help key) and press that key.

Key Path	Front-panel key
Initial S/W Revision	Prior to A.02.00

Remote Measurement Functions

This section contains the following topics:

"Measurement Group of Commands" on page 2016

"Current Measurement Query (Remote Command Only)" on page 2018

"Limit Test Current Results (Remote Command Only)" on page 2018

"Data Query (Remote Command Only)" on page 2018

"Calculate/Compress Trace Data Query (Remote Command Only)" on page 2019

"Calculate Peaks of Trace Data (Remote Command Only)" on page 2024

"Hardware-Accelerated Fast Power Measurement (Remote Command Only)" on page 2025

"Format Data: Numeric Data (Remote Command Only)" on page 2039

"Format Data: Byte Order (Remote Command Only)" on page 2040

Initial S/W Revision	Prior to A.02.00
----------------------	------------------

Measurement Group of Commands

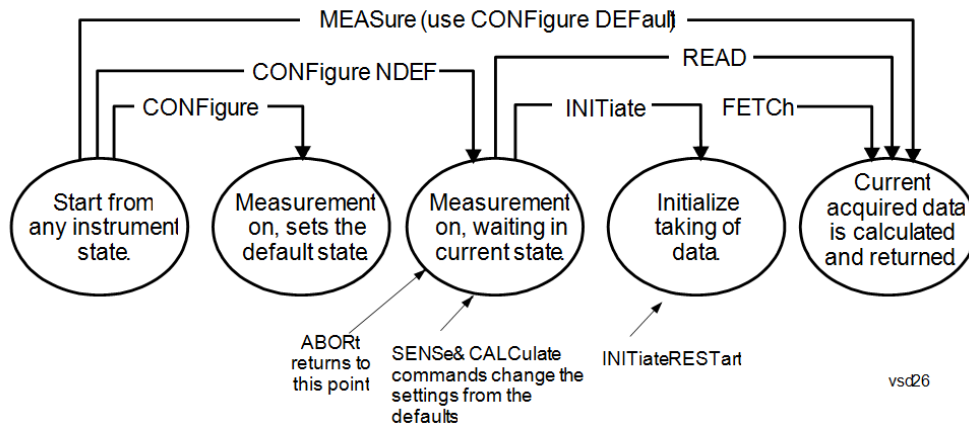

Measure Commands:

:MEASure:<measurement>[n]?

This is a fast single-command way to make a measurement using the factory default instrument settings. These are the settings and units that conform to the Mode Setup settings (e.g. radio standard) that you have currently selected.

- Stops the current measurement (if any) and sets up the instrument for the specified measurement using the factory defaults
- Initiates the data acquisition for the measurement
- Blocks other SCPI communication, waiting until the measurement is complete before returning results.
- If the function does averaging, it is turned on and the number of averages is set to 10.
- After the data is valid it returns the scalar results, or the trace data, for the specified measurement. The type of data returned may be defined by an [n] value that is sent with the command.
- The scalar measurement results will be returned if the optional [n] value is not included, or is set to 1. If the [n] value is set to a value other than 1, the selected trace data results will be returned. See each command for details of what types of scalar results or trace data results are available.
- ASCII is the default format for the data output. (Older versions of Spectrum Analysis and Phase Noise mode measurements only use ASCII.) The binary data formats should be used for handling large blocks of data since they are smaller and faster than the ASCII format. Refer to the FORMat:DATA command for more information.

If you need to change some of the measurement parameters from the factory default settings you can set up the measurement with the CONFigure command. Use the commands in the SENSE:<measurement> and CALCulate:<measurement> subsystems to change the settings. Then you can use the READ? command to initiate the measurement and query the results.

If you need to repeatedly make a given measurement with settings other than the factory defaults, you can use the commands in the SENSE:<measurement> and CALCulate:<measurement> subsystems to set up the measurement. Then use the READ? command to initiate the measurement and query results.

Measurement settings persist if you initiate a different measurement and then return to a previous one. Use READ:<measurement>? if you want to use those persistent settings. If you want to go back to the default settings, use MEASure:<measurement>?.

Configure Commands:

:CONFigure:<measurement>

This command stops the current measurement (if any) and sets up the instrument for the specified measurement using

the factory default instrument settings. It does not initiate the taking of measurement data unless INIT:CONTInuous is ON. If you change any measurement settings after using the CONFigure command, the READ command can be used to initiate a measurement without changing the settings back to their defaults.

In the Swept SA measurement in Spectrum Analyzer mode the CONFigure command also turns the averaging function on and sets the number of averages to 10 for all measurements.

:CONFigure: <measurement>: NDEFault stops the current measurement and changes to the specified measurement. It does not change the settings to the defaults. It does not initiate the taking of measurement data unless INIT:CONTInuous is ON.

The CONFigure? query returns the current measurement name.

The CONFigure:CATalog? query returns a quoted string of all licensed measurement names in the current mode. For example, "SAN, CHP, OBW, ACP, PST, TXP, SPUR, SEM, LIST".

Fetch Commands:

:FETCh:<measurement>[n]?

This command puts selected data from the most recent measurement into the output buffer. Use FETCh if you have already made a good measurement and you want to return several types of data (different [n] values, for example, both scalars and trace data) from a single measurement. FETCh saves you the time of re-making the measurement. You can only FETCh results from the measurement that is currently active, it will not change to a different measurement. An error message is reported if a measurement other than the current one is specified.

If you need to get new measurement data, use the READ command, which is equivalent to an INITiate followed by a FETCh.

The scalar measurement results will be returned if the optional [n] value is not included, or is set to 1. If the [n] value is set to a value other than 1, the selected trace data results will be returned. See each command for details of what types of scalar results or trace data results are available. The binary data formats should be used for handling large blocks of data since they are smaller and transfer faster than the ASCII format. (FORMat:DATA)

FETCh may be used to return results other than those specified with the original READ or MEASure command that you sent.

INITiate Commands:

:INITiate:<measurement>

This command is not available for measurements in all the instrument modes:

- Initiates a trigger cycle for the specified measurement, but does not output any data. You must then use the FETCh<meas> command to return data. If a measurement other than the current one is specified, the instrument will switch to that measurement and then initiate it.
 - For example, suppose you have previously initiated the ACP measurement, but now you are running the channel power measurement. If you send INIT:ACP? it will change from channel power to ACP and will initiate an ACP measurement.
 - Does not change any of the measurement settings. For example, if you have previously started the ACP measurement and you send INIT:ACP? it will initiate a new ACP measurement using the same instrument settings as the last time ACP was run.
 - If your selected measurement is currently active (in the idle state) it triggers the measurement, assuming the trigger conditions are met. Then it completes one trigger cycle. Depending upon the measurement and the number of averages, there may be multiple data acquisitions, with multiple trigger events, for one full trigger cycle. It also holds off additional commands on GPIB until the acquisition is complete.
-

READ Commands:

:READ:<measurement>[n]?

- Does not preset the measurement to the factory default settings. For example, if you have previously initiated the ACP
-

measurement and you send READ:ACP? it will initiate a new measurement using the same instrument settings.

- Initiates the measurement and puts valid data into the output buffer. If a measurement other than the current one is specified, the instrument will switch to that measurement before it initiates the measurement and returns results.
 - For example, suppose you have previously initiated the ACP measurement, but now you are running the channel power measurement. Then you send READ:ACP? It will change from channel power back to ACP and, using the previous ACP settings, will initiate the measurement and return results.
 - Blocks other SCPI communication, waiting until the measurement is complete before returning the results
 - If the optional [n] value is not included, or is set to 1, the scalar measurement results will be returned. If the [n] value is set to a value other than 1, the selected trace data results will be returned. See each command for details of what types of scalar results or trace data results are available. The binary data formats should be used when handling large blocks of data since they are smaller and faster than the ASCII format. (FORMat:DATA)
-

Initial S/W Revision	Prior to A.02.00
----------------------	------------------

Current Measurement Query (Remote Command Only)

This command returns the name of the measurement that is currently running.

Remote Command	:CONFigure?
-----------------------	-------------

Example	CONF?
----------------	-------

Initial S/W Revision	Prior to A.02.00
----------------------	------------------

Limit Test Current Results (Remote Command Only)

Queries the status of the current measurement limit testing. It returns a 0 if the measured results pass when compared with the current limits. It returns a 1 if the measured results fail any limit tests.

Remote Command	:CALCulate:CLIMits:FAIL?
-----------------------	--------------------------

Example	CALC:CLIM:FAIL? queries the current measurement to see if it fails the defined limits. Returns a 0 or 1: 0 it passes, 1 it fails.
----------------	--

Initial S/W Revision	Prior to A.02.00
----------------------	------------------

Data Query (Remote Command Only)

Returns the designated measurement data for the currently selected measurement and subopcode.

n = any valid subopcode for the current measurement. See the measurement command results table for your current measurement, for information about what data is returned for the subopcodes.

This command uses the data setting specified by the FORMat:BORDER and FORMat:DATA commands and can return real or ASCII data. (See the format command descriptions under Input/Output in the Analyzer Setup section.)

Remote Command	:CALCulate:DATA[n]?
Notes	The return trace depends on the measurement. In CALCulate:<meas>:DATA[n], n is any valid subopcode for the current measurement. It returns the same data as the FETCH:<measurement>? query where <measurement> is the current measurement.
Initial S/W Revision	Prior to A.02.00

Calculate/Compress Trace Data Query (Remote Command Only)

Returns compressed data for the currently selected measurement and sub-opcode [n].

n = any valid sub-opcode for that measurement. See the MEASure:<measurement>? command description of your specific measurement for information on the data that can be returned.

The data is returned in the current Y Axis Unit of the analyzer. The command is used with a sub-opcode <n> (default=1) to specify the trace. With trace queries, it is best if the analyzer is not sweeping during the query. Therefore, it is generally advisable to be in Single Sweep, or Update=Off.

This command is used to compress or decimate a long trace to extract and return only the desired data. A typical example would be to acquire N frames of GSM data and return the mean power of the first burst in each frame. The command can also be used to identify the best curve fit for the data.

Remote Command	:CALCulate:DATA<n>:COMPRESS? BLOCK CFIT MAXimum MINimum MEAN DMEan RMS RMSCubed SAMPLE SDEVIation PPHase [,<soffset> [,<length>[,<roffset>[,<rlimit>]]]]
Example	To query the mean power of a set of GSM bursts: Supply a signal that is a set of GSM bursts. Select the IQ Waveform measurement (in IQ Analyzer Mode). Set the sweep time to acquire at least one burst. Set the triggers such that acquisition happens at a known position relative to a burst. Then query the mean burst levels using, CALC:DATA2:COMP? MEAN, 24e-6, 526e-6 (These parameter values correspond to GSM signals, where 526e-6 is the length of the burst in the slot and you just want 1 burst.)
Notes	The command supports 5 parameters. Note that the last 4 (<soffset>, <length>, <roffset>, <rlimit>) are optional. But these optional parameters must be entered in the specified order. For example, if you want to specify <length>, then you must also specify <soffset>. See details below for a definition of each of these parameters. This command uses the data in the format specified by FORMat:DATA, returning either binary or ASCII data.
Initial S/W Revision	Prior to A.02.00

- BLOCK or block data - returns all the data points from the region of the trace data that you specify. For example, it could be used to return the data points of an input signal over several timeslots, excluding the portions of the trace data that you do not want. (This is x,y pairs for trace data and I,Q pairs for complex data.)

- CFIT or curve fit - applies curve fitting routines to the data. <soffset> and <length> are required to define the data that you want. <roffset> is an optional parameter for the desired order of the curve equation. The query will return the following values: the x-offset (in seconds) and the curve coefficients ((order + 1) values).

MIN, MAX, MEAN, DME, RMS, RMSC, SAMP, SDEV and PPH return one data value for each specified region (or <length>) of trace data, for as many regions as possible until you run out of trace data (using <roffset> to specify regions). Or they return the number of regions you specify (using <rlimit>) ignoring any data beyond that.

- MINimum - returns the minimum data point (y value) for the specified region(s) of trace data. For I/Q trace data, the minimum magnitude of the I/Q pairs is returned.
- MAXimum - returns the maximum data point (y value) for the specified region(s) of trace data. For I/Q trace data, the maximum magnitude of the I/Q pairs is returned.
- MEAN - returns a single value that is the arithmetic mean of the data point values (in dB/ dBm) for the specified region(s) of trace data. For I/Q trace data, the mean of the magnitudes of the I/Q pairs is returned. See the following equations.

-

NOTE

If the original trace data is in dB, this function returns the arithmetic mean of those log values, not log of the mean power which is a more useful value. The mean of the log is the better measurement technique when measuring CW signals in the presence of noise. The mean of the power, expressed in dB, is useful in power measurements such as Channel Power. To achieve the mean of the power, use the RMS option.

Equation 1

Mean Value of Data Points for Specified Region(s)

$$\text{MEAN} = \frac{1}{n} \sum_{X_i \in \text{region}(s)} X_i$$

where X_i is a data point value, and n is the number of data points in the specified region(s).

Equation 2

Mean Value of I/Q Data Pairs for Specified Region(s)

$$\text{MEAN} = \frac{1}{n} \sum_{X_i \in \text{region}(s)} |X_i|$$

where $|X_i|$ is the magnitude of an I/Q pair, and n is the number of I/Q pairs in the specified region(s).

- DMEan - returns a single value that is the mean power (in dB/ dBm) of the data point values for the specified region(s) of trace data. See the following equation:

Equation 3

DMEan Value of Data Points for Specified Region(s)

$$\text{DME} = 10 \times \log_{10} \left(\frac{1}{n} \sum_{X_i \in \text{region}(s)} 10^{\frac{X_i}{10}} \right)$$

- RMS - returns a single value that is the average power on a root-mean-squared voltage scale (arithmetic rms) of the data point values for the specified region(s) of trace data. See the following equation.

NOTE For I/Q trace data, the rms of the magnitudes of the I/Q pairs is returned. See the following equation. This function is very useful for I/Q trace data. However, if the original trace data is in dB, this function returns the rms of the log values which is not usually needed.

Equation 4

RMS Value of Data Points for Specified Region(s)

$$\text{RMS} = \sqrt{\frac{1}{n} \sum_{X_i \in \text{region}(s)} X_i^2}$$

where X_i is a data point value, and n is the number of data points in the specified region(s).

Equation 5

RMS Value of I/Q Data Pairs for Specified Region(s)

$$\text{RMS} = \sqrt{\frac{1}{n} \sum_{X_i \in \text{region}(s)} X_i X_i^*}$$

where X_i is the complex value representation of an I/Q pair, X_i^* its conjugate complex number, and n is the number of I/Q pairs in the specified region(s).

Once you have the rms value for a region of trace data (linear or I/Q), you may want to calculate the mean power. You must convert this rms value (peak volts) to power in dBm:

$$10 \times \log[10 \times (\text{rms value})^2]$$

- SAMPlE - returns the first data value (x,y pair) for the specified region(s) of trace data. For I/Q trace data, the first I/Q pair is returned.
- SDEVIation - returns a single value that is the arithmetic standard deviation for the data point values for the specified region(s) of trace data. See the following equation.
- For I/Q trace data, the standard deviation of the magnitudes of the I/Q pairs is returned. See the following equation.

Equation 6

Standard Deviation of Data Point Values for Specified Region(s)

$$\text{SDEV} = \sqrt{\frac{1}{n} \sum_{X_i \in \text{region}(s)} (X_i - \bar{X})^2}$$

where X_i is a data point value, \bar{X} is the arithmetic mean of the data point values for the specified region (s), and n is the number of data points in the specified region(s).

$$\text{SDEV} = \sqrt{\frac{1}{n} \sum_{X_i \in \text{region}(s)} (|X_i| - \bar{X})^2}$$

where $|X_i|$ is the magnitude of an I/Q pair, \bar{X} is the mean of the magnitudes for the specified region(s), and n is the number of data points in the specified region(s).

- PPHase - returns the x,y pairs of both rms power (dBm) and arithmetic mean phase (radian) for every specified region and frequency offset (Hz). The number of pairs is defined by the specified number of regions. This parameter can be used for I/Q vector ($n=0$) in Waveform (time domain) measurement and all parameters are specified by data point in PPHase.

The rms power of the specified region may be expressed as:

$$\text{Power} = 10 \times \log [10 \times (\text{RMS I/Q value})] + 10.$$

The RMS I/Q value (peak volts) is:

$$\sqrt{\frac{1}{n} \sum_{X_i \in \text{region}} X_i X_i^*}$$

where X_i is the complex value representation of an I/Q pair, X_i^* its conjugate complex number, and n is the number of I/Q pairs in the specified region.

The arithmetic mean phase of the specified region may be expressed as:

$$\frac{1}{n} \sum_{Y_i \in \text{region}} Y_i$$

where Y_i is the unwrapped phase of I/Q pair with applying frequency correction and n is the number of I/Q pairs in the specified region.

The frequency correction is made by the frequency offset calculated by the arithmetic mean of every specified region's frequency offset. Each frequency offset is calculated by the least square method against the unwrapped phase of I/Q pair.

Sample Trace Data - Constant Envelope

(See below for explanation of variables.)

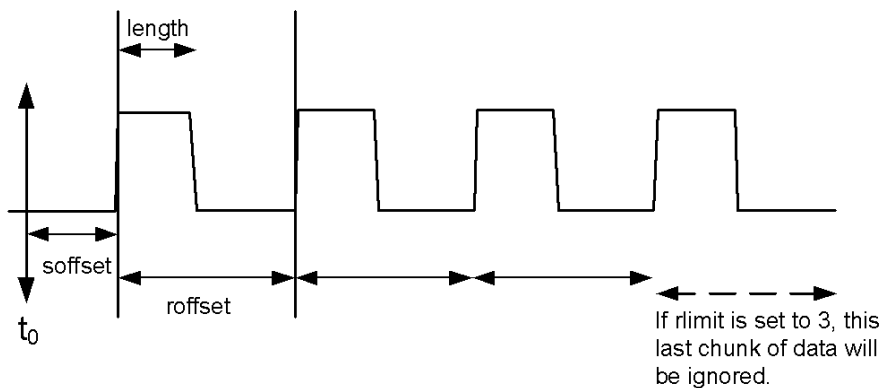

Sample Trace Data - Not Constant Envelope

(See below for explanation of variables.)

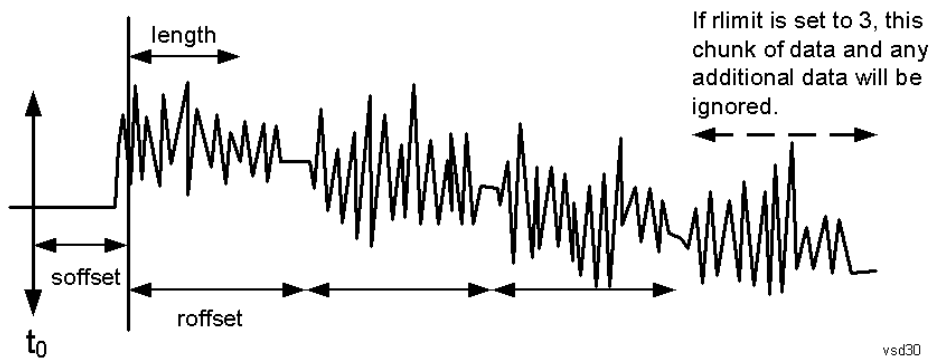

<soffset> - start offset is an optional real number. (It is in seconds for time-domain traces, and is a dimensionless index 0 to Npoints - 1, for frequency-domain traces). It specifies the amount of data at the beginning of the trace that will be ignored before the decimation process starts. It is the time or frequency change from the start of the trace to the point where you want to start using the data. The default value is zero.

<length> - is an optional real number. (It is in seconds for time-domain traces, and is a dimensionless index 0 to Npoints - 1, for frequency-domain traces). It defines how much data will be compressed into one value. This parameter has a default value equal to the current trace length.

<roffset> - repeat offset is an optional real number. (It is in seconds for time-domain traces, and is a dimensionless index 0 to Npoints - 1, for frequency-domain traces). It defines the beginning of the next field of trace elements to be compressed. This is relative to the beginning of the previous field. This parameter has a default value equal to the <length> variable. Note that this parameter is used for a completely different purpose when curve fitting (see CFIT above).

<rlimit> - repeat limit is an optional integer. It specifies the number of data items that you want returned. It will ignore any additional items beyond that number. You can use the Start offset and the Repeat limit to pick out exactly what part of the data you want to use. The default value is all the data.

Calculate Peaks of Trace Data (Remote Command Only)

Returns a list of all the peaks for the currently selected measurement and sub-opcode [n]. The peaks must meet the requirements of the peak threshold and excursion values.

n = any valid sub-opcode for the current measurement. See the MEASure:<measurement> command description of your specific measurement for information on the data that can be returned.

The command can only be used with specific sub-opcodes with measurement results that are trace data. Both real and complex traces can be searched, but complex traces are converted to magnitude in dBm. In many measurements the sub-opcode n=0, is the raw trace data which cannot be searched for peaks. And Sub-opcode n=1, is often calculated results values which also cannot be searched for peaks.

This command uses the data setting specified by the FORMat:BORDER and FORMat:DATA commands and can return real or ASCII data. If the format is set to INT,32, it returns REAL,32 data.

The command has four types of parameters:

- Threshold (in dBm)
- Excursion (in dB)
- Sorting order (amplitude, frequency, time)
- Optional in some measurements: Display line use (all, > display line, < display line)

Remote Command	<p>For Swept SA measurement:</p> <pre>:CALCulate:DATA[1] 2 ... 6:PEAKs? <threshold>,<excursion>[,AMPLitude FREQuency TIME[,ALL GTDLLine LTDLine]]</pre> <p>For most other measurements:</p> <pre>:CALCulate:DATA[1] 2 ... 6:PEAKs? <threshold>,<excursion>[,AMPLitude FREQuency TIME]</pre>
-----------------------	---

Example	<p>Example for Swept SA measurement in Spectrum Analyzer Mode:</p> <p>CALC:DATA4:PEAK? -40, 10, FREQ, GTDL This will identify the peaks of trace 4 that are above -40 dBm, with excursions of at least 10 dB. The peaks are returned in order of increasing frequency, starting with the lowest frequency. Only the peaks that are above the display line are returned.</p> <p>Query Results 1:</p> <p>With FORMat:DATA REAL, 32 selected, it returns a list of floating-point numbers. The first value in the list is the number of peak points that are in the following list. A peak point consists of two values: a peak amplitude followed by its corresponding frequency (or time).</p> <p>If no peaks are found the peak list will consist of only the number of peaks, (0).</p>
----------------	---

Notes	<p><n> - is the trace that will be used</p> <p><threshold> - is the level below which trace data peaks are ignored. Note that the threshold value is required and is always used as a peak criterion. To effectively disable the threshold criterion for this command, provide a substantially low threshold value such as -200 dBm. Also note that the threshold value used in this command is independent of and has no effect on the threshold value stored under the Peak Criteria menu.</p> <p><excursion> - is the minimum amplitude variation (rise and fall) required for a signal to be identified as peak. Note that the excursion value is required and is always used as a peak criterion. To effectively disable the excursion criterion for this command, provide the minimum value of 0.0 dB. Also note that the excursion value used in this command is independent of and has no effect on the</p>
--------------	---

excursion value stored under the Peak Criteria menu.

Values must be provided for threshold and excursion. The sorting and display line parameters are optional (defaults are AMPLitude and ALL).

Note that there is always a Y-axis value for the display line, regardless of whether the display line state is on or off. It is the current Y-axis value of the display line which is used by this command to determine whether a peak should be reported. Sorting order:

AMPLitude - lists the peaks in order of descending amplitude, with the highest peak first (default if optional parameter not sent)

FREQUENCY - lists the peaks in order of occurrence, left to right across the x-axis.

TIME - lists the peaks in order of occurrence, left to right across the x-axis.

Peaks vs. Display Line:

ALL - lists all of the peaks found (default if optional parameter not sent).

GTDLine (greater than display line) - lists all of the peaks found above the display line.

LTDLine (less than display line) - lists all of the peaks found below the display line.

Initial S/W Revision	Prior to A.02.00
----------------------	------------------

Hardware-Accelerated Fast Power Measurement (Remote Command Only)

The Fast Power option (FP2) enables very fast channel power measurements for instruments with the prerequisite hardware (DP2 and/or B40). It accomplishes this by performing real-time overlapped FFTs at the hardware layer, using software for basic post-processing before returning the result to the user. The upshot of this approach is improved throughput for user applications that require many sequential power measurements.

The analysis bandwidth of FP2 is limited by the licenses in the instrument, but its maximum overall analysis bandwidth per acquisition is 40 MHz.

FP2 is remote-only, which means the instrument does not switch to any particular mode or measurement. FP2 commands can be sent while another application is in use on the front panel.

Each Fast Power measurement can be predefined using an array index, and up to 1,000 measurements can be stored. In the following documentation, instances of [1,2,...,999] can be substituted with a particular measurement index, e.g. CALC:FPOW:POW1?, CALC:FPOW:POW2?, CALC:FPOW:POW134?. In this way, power measurements can be defined one time in a batch, and then executed multiple times without having to redefine them, similar to “list mode” on other measurements.

In addition to basic channel power measurements, there are a number of other measurement “functions” for each channel, including peak power, peak frequency, and power spectral density. See the Function parameter for more information.

Reset Fast Power Measurement (Remote Command Only)

Resets the measurement configuration to the defaults.

Mode	All
Remote Command	:CALCulate:FPOWer:POWer[1,2,...,999]:RESet
Example	:CALC:FPOW:POW1:RES

Notes	Option FP2 is required.
Initial S/W Revision	A.14.00

Define Fast Power Measurement (Remote Command Only)

Fast Power acquisitions are configured using the DEFine command. This command accepts a comma-delimited string of configuration parameters and their appropriate values, which are all specified in the subsection below.

Mode	All
Remote Command	:CALCulate:FPOWER:POWer[1,2,...,999]:DEFine "configuration string"
Example	:CALC:FPOW:POW1:DEF "CenterFrequency=2e9, AcquisitionTime=0.005"
Notes	See below for a list of measurement variables that can be defined in the configuration string.
Initial S/W Revision	A.14.00

Acquisition Time

Example	CALC:FPOW:POW1:DEF "AcquisitionTime=0.002"
Notes	The acquisition time parameter sets the time in which the entire spectrum is measured. An increase in the acquisition time yields an improvement in measurement repeatability.
Preset	0.001 s
Range	0 s to 1 s
Default Unit	Time (s)
Initial S/W Revision	A.14.00

Center Frequency

Example	CALC:FPOW:POW1:DEF "CenterFrequency=2e9"
Notes	The center frequency parameter sets the frequency in which the measurement is centered around. The OffsetFrequency parameter is calculated relative to the center frequency.
Preset	1 GHz
Range	0 Hz to maximum instrument frequency
Default Unit	Frequency (Hz)
Initial S/W Revision	A.14.00

DC Coupled

Example	CALC:FPOW:POW1:DEF "DCCoupled=True"
Notes	The DC coupled parameter allows the user to specify whether the DC blocking capacitor is utilized. Set parameter to true when measuring frequencies below 10 MHz.
Preset	False
Range	True (DC Coupled) or False (AC Coupled)
Default Unit	Boolean
Initial S/W Revision	A.14.00

DetectorType

Example	CALC:FPOW:POW1:DEF "DetectorType=Peak"
Notes	Option FP2 is required. The detector type parameter allows the user to choose whether a RMS average or peak value is used during the measurement.
Preset	RmsAverage
Range	RmsAverage, Peak
Initial S/W Revision	A.14.00

Do Noise Correction

Example	CALC:FPOW:POW1:DEF "DoNoiseCorrection=True"
Notes	When noise correction is enabled, the linear noise power contributed by the analyzer is subtracted from all measurements. This effectively lowers the noise floor of the analyzer. When noise correction is enabled, the first measurement for a given set of input parameters will take extra time. This is because the analyzer takes an extra acquisition with the RF input disconnected from the analyzer's front end to measure the noise of just the analyzer. The measured noise floor is stored in a cache so the noise acquisition will occur only once for the same state settings. In other words, if noise correction was turned on and the analyzer made an acquisition at frequency A, then frequency B, and back again to frequency A, the hidden initial noise floor acquisition would only occur for the first acquisition at frequency A and the cached noise floor would be used the second time frequency A was measured.
Preset	False
Range	True (enable noise correction) or False (disable noise correction)
Default Unit	Boolean
Initial S/W Revision	A.14.00

Do Spur Suppression

Example	CALC:FPOW:POW1:DEF "DoSpurSuppression=True"
Notes	<p>When measuring very low level signals, or when large out-of-band inputs are input into the analyzer, sometimes unwanted spurs and residuals can appear in the measured spectrum. Spur suppression is a method to help minimize the levels of these internally generated spurs and residuals.</p> <p>When spur suppression is enabled, the analyzer will automatically take two acquisitions using two different internal analog LO frequencies. The FFT spectrums from both acquisitions are combined by taking the minimum power between both traces on a per FFT bin basis. External signals will have the same amplitude for both traces and therefore will return the expected amplitudes. However, low level spurs and residuals generated internally to the analyzer tend to move to different FFT bins depending on the internal analog LO frequency used, and therefore tend to be suppressed using this spur suppression method.</p> <p>Because two acquisitions, rather than a single acquisition, are made when spur suppression is enabled, the measurement time will always be slower when spur suppression is enabled.</p>
Preset	False
Range	True (enable spur suppression) or False (disable spur suppression)
Default Unit	Boolean
Initial S/W Revision	A.14.00

Electronic Attenuator Bypass

Example	CALC:FPOW:POW1:DEF "ElecAttBypass =False"
Notes	The electronic attenuation bypass parameter allows the user to either utilize or bypass the electronic attenuator. The electronic attenuator is only available for frequencies up to 3.6 GHz. Set parameter to true when using frequencies above 3.6 GHz and set the parameter to false when using the preamp.
Preset	True
Range	True (bypass electronic attenuator) or False (use electronic attenuator)
Default Unit	Boolean
Initial S/W Revision	A.14.00

Electronic Attenuation

Example	CALC:FPOW:POW1:DEF "ElecAttenuation=10"
Notes	<p>Option EA3 is required.</p> <p>The electronic attenuation value parameter sets the amount of electrical attenuation from 0 to 24 dB (1 dB steps).</p> <p>Set "ElecAttBypass=False" to make sure the electronic attenuator path is enabled.</p>
Preset	0 dB
Range	0 – 24 dB (1 dB steps)

Default Unit	dB
Initial S/W Revision	A.14.00

IF Gain

Example	CALC:FPOW:POW1:DEF "IFGain=10"
Notes	The IF gain parameter allows the user to specify the gain at the IF stage anywhere from -6 to 16 dB (1 dB steps). This is an advanced feature, and for most cases this should remain at its default value of 0 dB.
Preset	0 dB
Range	-6 - 16 dB (1 dB steps)
Default Unit	dB
Initial S/W Revision	A.14.00

IF Type

Example	CALC:FPOW:POW1:DEF "IFType=B25M"
Notes	The IF type parameter allows the user to select between different IF paths. For example, if the signal is less than 25 MHz wide, then the user can select the B25M path to take advantage of additional filtering on this analog IF path.
Preset	B40M
Range	B10M, B25M, B40M
Initial S/W Revision	A.14.00

Include Power Spectrum

Example	CALC:FPOW:POW1:DEF "IncludePowerSpectrum=True"
Notes	The power spectrum parameter allows the user to read data on the entire spectrum for diagnostic purposes. It is not recommended for production use. See CALC:FPOW:POW[n]:READ2? for details on the binary format of the response.
Preset	False
Range	True (return both channel power and full power spectrum) or False (returns only channel power)
Default Unit	Boolean
Initial S/W Revision	A.14.00

Mechanical Attenuation

Example	CALC:FPOW:POW1:DEF "MechAttenuation=10"
Notes	The mechanical attenuation value parameter sets the amount of mechanical attenuation anywhere from 0 to 70 dB (2 dB steps).
Preset	0 dB
Range	0 – 70 dB (2 dB steps)
Default Unit	dB
Initial S/W Revision	A.14.00

Preamp Mode

Example	CALC:FPOW:POW1:DEF "PreAmpMode=Low"
Notes	The license for the appropriate preamp is required. The preamp mode parameter specifies whether the preamps are being utilized. Low allows any preamps up to 3.6 GHz, and Full allows all licensed preamps. Set "ElecAttBypass=True" in order to utilize any preamps.
Preset	Off
Range	Off, Low, Full
Initial S/W Revision	A.14.00

Resolution Bandwidth Mode

Example	CALC:FPOW:POW1:DEF "PreAmpMode=Low"
Notes	The resolution bandwidth mode parameter allows the user to choose whether the RBW filter is automatically or manually set. The BestSpeed value minimizes measurement time, while the Narrowest value minimizes RBW size (minimum of two FFT bins per RBW). To manually specify an RBW, set this parameter to Explicit, and set the ResolutionBW parameter to the desired value.
Preset	BestSpeed
Range	BestSpeed, Narrowest, Explicit
Initial S/W Revision	A.14.00

Resolution Bandwidth

Example	CALC:FPOW:POW1:DEF "ResolutionBW=25e3"
Notes	The resolution bandwidth parameter sets the 3-dB bandwidth of the RBW filter. The ResolutionBWMode parameter must be set to Explicit in order to manually set the RBW.

Preset	0 Hz
Default Unit	Hz
Initial S/W Revision	A.14.00

Trigger Delay

Example	CALC:FPOW:POW1:DEF "TriggerDelay=0.025"
Notes	The trigger delay parameter sets the time after an external trigger is detected until the measurement is performed.
Preset	0 s
Range	0 – 1 s
Default Unit	Seconds
Initial S/W Revision	A.14.00

Trigger Level

Example	CALC:FPOW:POW1:DEF "TriggerLevel=2"
Notes	The trigger level parameter sets the voltage value at which an external trigger is detected.
Preset	1.2 V
Range	-5 to 5 V
Default Unit	Volts
Initial S/W Revision	A.14.00

Trigger Slope

Example	CALC:FPOW:POW1:DEF "TriggerSlope=Negative"
Notes	The trigger slope parameter indicates the direction of the edge trigger voltage for detection.
Preset	Positive
Range	Positive, Negative
Initial S/W Revision	A.14.00

Trigger Source

Example	CALC:FPOW:POW1:DEF "TriggerSource=Ext1"
Notes	The trigger source parameter allows the user to choose between measurement's triggering freely or controlled by an external input. Ext1 and Ext2 correspond to Trigger 1 In and Trigger 2 In, respectively.
Preset	Free
Range	Free, Ext1, Ext2
Initial S/W Revision	A.14.00

Trigger Timeout

Example	CALC:FPOW:POW1:DEF "TriggerTimeout=0.1"
Notes	The trigger timeout parameter sets the time in which the analyzer will wait for a trigger before automatically performing the measurement.
Preset	1 s
Range	0 - 1 s
Default Unit	Seconds
Initial S/W Revision	A.14.00

Signal Input

Example	CALC:FPOW:POW1:DEF "SignalInput=Fp50MHzCW"
Notes	The signal input parameter allows the user to select between using the main RF input or the internal analyzer reference CW signal of 50 MHz.
Preset	FpMainRf
Range	FpMainRf, Fp50MHzCW
Initial S/W Revision	A.14.00

Use Preselector

Example	CALC:FPOW:POW1:DEF "UsePreSelector=True"
Notes	The preselector parameter allows the user to either utilize or bypass the front end tunable filter at frequencies above 3.6 GHz. For frequencies below 3.6 GHz, the preselector is automatically bypassed, so you do not need to set this parameter to False in those cases.
Preset	False
Range	True (use preselector above 3.6 GHz), or False (preselector bypassed)

Default Unit	Boolean
Initial S/W Revision	A.14.00

Channel Bandwidth Array

Example	CALC:FPOW:POW1:DEF "Bandwidth=[3.84e6, 5e6, 3.84e6]"
Notes	The bandwidth parameter array defines the bandwidth of each channel that will be measured. All array parameters should have the same number of elements. Alternatively, if all the elements are the same value, a single number with no square brackets can be used to define the parameter.
Preset	[1 e6]
Range	0 to 40 MHz
Default Unit	Hz
Initial S/W Revision	A.14.00

Channel Filter Type Array

Example	CALC:FPOW:POW1:DEF "FilterType=[RRC, IBW, RRC]"
Notes	The filter type parameter allows the user to choose between an integration bandwidth (IBW) filter or a root-raised-cosine (RRC) filter. The integration bandwidth filter weighs all frequencies within the bandwidth equally. The root-raised-cosine filter has an associated shape parameter, defined by the FilterAlpha parameter. All array parameters should have the same number of elements. Alternatively, if all the elements are the same value, a single value with no square brackets can be used to define the parameter.
Preset	[IBW]
Range	IBW, RRC
Initial S/W Revision	A.14.00

Channel Filter Alpha Array

Example	CALC:FPOW:POW1:DEF "FilterAlpha=[0.5, 0.0, 0.5]"
Notes	The filter alpha parameter allows the user to adjust the alpha value associated with the root-raised-cosine (RRC) filter type. Set FilterType to RRC in order to utilize this parameter. All array parameters should have the same number of elements. Alternatively, if all the elements are the same value, a single number with no square brackets can be used to define the parameter.
Preset	[0.22]
Range	0.0 – 1.0

Initial S/W Revision	A.14.00
-------------------------	---------

Channel Measurement Function Array

Example	CALC:FPOW:POW1:DEF "Function=[BandPower, PeakPower, BandPower]"
Notes	<p>This parameter array defines what measurement is being made for each individually-specified channel:</p> <p>BandPower: Total power within the specified bandwidth of the channel (dBm)</p> <p>BandDensity: Total power density within the specified bandwidth of the channel (dBm/Hz)</p> <p>PeakPower: The peak power value within the specified bandwidth of the channel (dBm)</p> <p>PeakFrequency: The frequency which corresponds to the peak power value within the specified bandwidth of the channel. This frequency is relative to the center frequency (Hz)</p> <p>XdBBandwidth: The half power (-3.01 dB) bandwidth of the highest amplitude signal that resides within the channel (Hz), dB is configurable using XdBBandwidth parameter</p> <p>OccupiedBandwidth: The bandwidth at which 99% of the total power resides within the channel (Hz), percentage configurable using OccupiedBandwidthPercent parameter</p> <p>All array parameters should have the same number of elements. Alternatively, if all the elements are the same value, a single value with no square brackets can be used to define the parameter.</p>
Preset	[BandPower]
Range	BandPower, BandDensity, PeakPower, PeakFrequency, XdBBandwidth, OccupiedBandwidth
Initial S/W Revision	A.14.00

Channel Offset Frequency Array

Example	CALC:FPOW:POW1:DEF "OffsetFrequency=[-5e6, 0, 5e6]"
Notes	<p>The offset frequency parameter array defines the difference between the center frequency to the center frequency of each channel.</p> <p>All array parameters should have the same number of elements.</p>
Preset	[0]
Range	0 to 20 MHz
Default Unit	Hz
Initial S/W Revision	A.14.00

Channel Occupied Bandwidth Percent Array

Example	CALC:FPOW:POW1:DEF "OccupiedBandwidthPercent =[0.95, 0.95, 0.95]"
Notes	This parameter only applies for channels whose Function is set to OccupiedBandwidth. The occupied

bandwidth percent parameter specifies the percent of total power in these channels. The valid range for this parameter is 0.0 to 1.0, where 1.0 represents 100%. The default for this parameter is 0.99, which will return the bandwidth that contains 99% of the total channel power.

Preset	[0.99]
Range	0 – 1.0
Initial S/W Revision	A.14.00

Channel x-dB Bandwidth Array

Example	CALC:FPOW:POW1:DEF " XdBBandwidth =[-6.02, -3.01, -1.0]"
Notes	This parameter only applies for channels whose Function is set to XdBBandwidth. The X dB bandwidth parameter is used to specify the power relative to the peak channel power over which the bandwidth is calculated. The parameter value must be a negative number.
Preset	[-3.01]
Range	-200 to 0 dB
Default Unit	dB
Initial S/W Revision	A.14.00

Define Fast Power Measurement Query (Remote Command Only)

The DEFine? command is used to retrieve a list of all defined parameters in an ASCII string format

```

M All
o
d
e
R :CALCulate:FPOWER:POWer [1,2,...,999]:DEFine?
e
m
o
t
e
C
o
m
m
a
n
d
E :CALC:FPOW:POW1:DEF?

```

```
x
a
m
p
l
e
-----
N This command query is used to retrieve a list of all defined parameters in an ASCII format.
o The following is an example of the returned results:
t "DCCoupled=False,ElecAttBypass=True,ElecAttenuation=0,IFGain=0,MechAttenuation=0,PreAmpMode=Off,PreSelectorOffset
e =0,UsePreSelector=False,ExternalReferenceFrequency=10000000,FrequencyReferenceSource=AutoExternalFrequencyRefer
s ence,IFType=B40M,LOMode=SLW,SignalInput=FpMainRf,AcquisitionTime=0.001,CenterFrequency=1000000000,Resolution
BW=0,ResolutionBWMode=BestSpeed,DetectorType=RmsAverage,Bandwidth=[1000000],OffsetFrequency=[0],Function=
[BandPower],FilterType=[IBW],FilterAlpha=[0.22],OccupiedBandwidthPercent=[0.99],XdBBandwidth=[-
3.01],DoNoiseCorrection=False,DoSpurSuppression=False,MeasurementMethod=HardwareFFT,IncludePowerSpectrum=False,
e,TriggerDelay=0,TriggerLevel=1.2,TriggerSlope=Positive,TriggerSource=Free,TriggerTimeout=1"
-----
I A.14.00
n
i
t
i
a
l
S
/
W
R
e
v
i
s
i
o
n
-----
```

Configure Fast Power Measurement (Remote Command Only)

The configure command begins hardware setup and returns immediately, with no acquisition made. This can be used in parallel with other hardware operations to effectively hide the hardware setup time.

Mode	All
Remote Command	:CALCulate:FPOWer:POWer[1,2,...,999]:CONFigure
Example	:CALC:FPOW:POW1:CONF
Notes	Option FP2 is required.
Initial S/W Revision	A.14.00

Initiate Fast Power Measurement (Remote Command Only)

The INITiate command begins an acquisition and returns immediately. The results of the measurement can be retrieved using FETCh.

Mode	All
Remote Command	:CALCulate:FPOWER:POWER[1,2,...,999]:INITiate
Example	:CALC:FPOW:POW1:INIT
Notes	Option FP2 is required.
Initial S/W Revision	A.14.00

Fetch Fast Power Measurement (Remote Command Only)

The FETCh command query is used to retrieve the results of an acquisition initiated by the INIT command. The returned results are in ASCII string format. The string begins and ends with quotation marks.

Mode	All
Remote Command	:CALCulate:FPOWER:POWER[1,2,...,999]:FETCh?
Example	:CALC:FPOW:POW1:FETC?
Notes	Option FP2 is required. Returns m comma-separated ASCII values, where m corresponds to the number of bandwidths defined. 1. Declared function return in the 1st specified channel 2. Declared function return in the 2nd specified channel ... m. Declared function return in the last specified channel The INIT and FETC? command sequence performs the same functionality of a single CALC:FPOW:POW[n]? query. Units of the returned values are dependent on the Function parameter for each channel.
Initial S/W Revision	A.14.00

Execute Fast Power Measurement (Remote Command Only)

This command query is used as shorthand for an INIT command immediately followed by a FETC? command. The returned results are in ASCII string format. The string begins and ends with quotation marks.

Mode	All
Remote Command	:CALCulate:FPOWER:POWER[1,2,...,999]?
Example	:CALC:FPOW:POW1?

Notes	Option FP2 is required. See notes for Fast Power Fetch for return format.
Initial S/W Revision	A.14.00

Binary Read Fast Power Measurement (Remote Command Only)

This command query is used as shorthand for an INIT command immediately followed by a FETC? command. The returned results are in a binary format.

Mode	All
Remote Command	:CALCulate:FPOWER:POWER[1,2,...,999]:READ? :CALCulate:FPOWER:POWER[1,2,...,999]:READ1?
Example	:CALC:FPOW:POW1:READ? :CALC:FPOW:POW1:READ1?
Notes	Option FP2 is required. Returns m 4 byte floating point binary values (Little-Endian), where m corresponds to the number of bandwidths defined.
Initial S/W Revision	A.14.00

Diagnostic Binary Read Fast Power Measurement (Remote Command Only)

This command query is used as shorthand for an INIT command immediately followed by a FETC? command. The returned results are in a binary format. This command is used primarily for diagnostic purposes to test for ADC overloads and to visibly inspect the spectrum.

Mode	All
Remote Command	:CALCulate:FPOWER:POWER[1,2,...,999]:READ2?
Example	:CALC:FPOW:POW1:READ2?
Notes	Option FP2 is required. Note: Spectrum data is only returned if the IncludePowerSpectrum parameter is set to True. If IncludePowerSpectrum is False, the number of spectrum points will be zero (0). Units of the returned values are dependent on the Function parameter per channel (e.g. dBm for BandPower, Hz for PeakFrequency). Returns binary data (Little-Endian) that contains information on m amount of channels, along with ADC over range and full spectrum data. The following is the binary format of the response. Bandwidth Return Value 1. Number of channels specified, m [4 byte int] 2. Declared function result for the 1st specified channel [4 byte float]

-
- 3. Declared function result for the 2nd specified channel [4 byte float]
 - ...
 - (m + 1). Declared function result for the last (mth) specified channel [4 byte float]
 - ADC Over Range
 - 1. ADC over-range occurred (1: true, 0: false) [2 byte short]
 - Spectrum Data
 - 1. Number of points in the spectrum data, k [4 byte int]
 - 2. Start frequency of spectrum data (Hz) [8 byte double]
 - 3. Step frequency of spectrum data (Hz) [8 byte double]
 - 4. FFT bin at 1st point (dBm) [4 byte float]
 - 5. FFT bin at 2nd point (dBm) [4 byte float]
 - ...
 - (k + 3). FFT bin at last (kth) point (dBm) [4 byte float]
-

Initial S/W Revision	A.14.00
-------------------------	---------

Format Data: Numeric Data (Remote Command Only)

This command specifies the format of the trace data input and output. It specifies the formats used for trace data during data transfer across any remote port. It affects only the data format for setting and querying trace data for the :TRACe[:DATA], TRACe[:DATA]?, :CALCulate:DATA[n]? and FETCh:SANalyzer [n]? commands and queries.

Remote Command	:FORMat[:TRACe][:DATA] ASCii INTEger,32 REAL,32 REAL,64 :FORMat[:TRACe][:DATA]?
Notes	<p>The query response is:</p> <p>ASCii: ASC,8 REAL,32: REAL,32 REAL,64: REAL,64 INTEger,32: INT,32</p> <p>When the numeric data format is REAL or ASCii, data is output in the current Y Axis unit. When the data format is INTEger, data is output in units of m dBm (.001 dBm).</p> <p>The INT,32 format returns binary 32-bit integer values in internal units (m dBm), in a definite length block.</p>
Dependencies	<p>Sending a data format spec with an invalid number (for example, INT,48) generates no error. The analyzer simply uses the default (8 for ASCii, 32 for INTEger, 32 for REAL).</p> <p>Sending data to the analyzer which does not conform to the current FORMat specified, results in an error. Sending ASCII data when a definite block is expected generates message -161 "Invalid Block Data" and sending a definite block when ASCII data is expected generates message -121 "Invalid Character in Number".</p>
Preset	ASCii
Backwards Compatibility	Note that the INT,32 format is only applicable to the command, TRACe:DATA. This preserves

Notes	backwards compatibility for the Swept SA measurement. For all other commands/queries which honor FORMat:DATA, if INT,32 is sent the analyzer will behave as though it were set to REAL,32.
Initial S/W Revision	Prior to A.02.00

The specs for each output type follow:

ASCIi - Amplitude values are in ASCII, in the current Y Axis Unit, one ASCII character per digit, values separated by commas, each value in the form:

SX.YYYYYEsZZ

Where:

S = sign (+ or -)

X = one digit to left of decimal point

Y = 5 digits to right of decimal point

E = E, exponent header

s = sign of exponent (+ or -)

ZZ = two digit exponent

REAL,32 - Binary 32-bit real values in the current Y Axis Unit, in a definite length block.

REAL,64 - Binary 64-bit real values in the current Y Axis Unit, in a definite length block.

Format Data: Byte Order (Remote Command Only)

This command selects the binary data byte order for data transfer and other queries. It controls whether binary data is transferred in normal or swapped mode. This command affects only the byte order for setting and querying trace data for the :TRACe[:DATA], TRACe[:DATA]? , :CALCulate:DATA[n]? and FETCh:SANalyzer[n]? commands and queries.

By definition any command that says it uses FORMat:DATA uses any format supported by FORMat:DATA.

The NORMal order is a byte sequence that begins with the most significant byte (MSB) first, and ends with the least significant byte (LSB) last in the sequence: 1|2|3|4. SWAPped order is when the byte sequence begins with the LSB first, and ends with the MSB last in the sequence: 4|3|2|1.

Remote Command	:FORMat:BORDer NORMal SWAPped :FORMat:BORDer?
Preset	NORMal
Initial S/W Revision	Prior to A.02.00

Meas Setup

Displays the setup menu for the currently selected measurement. The parameters included in this menu are as follows.

Averaging

IF Gain

Channel Power Span

Integrated Bandwidth

Filter Bandwidth

Root Raised Cosine (RRC) Filter

Key Path	Front-panel key
Initial S/W Revision	Prior to A.02.00

Avg/Hold Num

Specifies the number of measurement averages used to calculate the measurement result. The average is displayed at the end of each sweep. After the specified number of average counts, the averaging mode (terminal control) setting determines the averaging action.

Key Path	Meas Setup
Mode	SA, WCDMA, C2K, WIMAX OFDMA, 1xEVDO, DVB-T/H, DTMB (CTTB), ISDB-T, CMMB, LTE, LTETDD, Digital Cable TV, WLAN, MSR, LTEAFDD, LTEATDD
Remote Command	[:SENSe]:CHPower:AVERage:COUNT <integer> [:SENSe]:CHPower:AVERage:COUNT? [:SENSe]:CHPower:AVERage[:STATe] ON OFF 1 0 [:SENSe]:CHPower:AVERage[:STATe]?
Example	CHP:AVER:COUN 15 CHP:AVER:COUN? CHP:AVER ON CHP:AVER?
Notes	You must be in the Spectrum Analysis mode, W-CDMA mode, cdma2000 mode, DVB-T/H mode, DTMB (CTTB) mode, ISDB-T mode, CMMB mode, Digital Cable TV mode, LTE mode, LTE TDD mode 1xEVDO mode or WIMAX OFDMA mode to use this command. Use :INSTRument:SElect to set the mode.
Preset	SA: 10 WCDMA: 200 WIMAX OFDMA, LTE, LTETDD, MSR: 200 CDMA2K: 20 1xEVDO: 20

	DVB-T/H: 20 DTMB (CTTB): 20 ISDB-T: 10 CMMB: 10 Digital Cable TV: 10 WLAN: 10 LTEAFDD, LTEATDD:200 ON
State Saved	Saved in instrument state.
Min	1
Max	10000
Initial S/W Revision	Prior to A.02.00
Modified at S/W Revision	A.02.00, A.03.00

Avg Mode

Allows you to select the type of termination control used for the averaging function. This determines the averaging action after the specified number of data acquisitions (average count) is reached.

When set to Exponential (Exp) the measurement averaging continues using the specified number of averages to compute each exponentially-weighted averaged value. The average is displayed at the end of each sweep.

When set to Repeat, the measurement resets the average counter each time the specified number of averages is reached.

Key Path	Meas Setup
Mode	SA, WCDMA, C2K, WIMAX OFDMA, 1xEVDO, DVB-T/H, DTMB (CTTB), ISDB-T, CMMB, LTE, LTEATDD, Digital Cable TV, WLAN, MSR, LTEAFDD, LTEATDD
Remote Command	[:SENSe] :CHPower:AVERage:TCONtrol EXPonential REPeat [:SENSe] :CHPower:AVERage:TCONtrol?
Example	CHP:AVER:TCON EXP CHP:AVER:TCON?
Notes	You must be in the Spectrum Analysis mode, W-CDMA mode, cdma2000 mode, DVB-T/H mode, DTMB (CTTB) mode, ISDB-T mode, CMMB mode, Digital Cable TV mode, LTE mode, LTE TDD mode, WLAN mode, 1xEVDO mode or WIMAX OFDMA mode to use this command. Use :INSTrument:SElect to set the mode.
Preset	EXP
State Saved	Saved in instrument state.
Range	Exp Repeat
Initial S/W Revision	Prior to A.02.00
Modified at S/W Revision	A.02.00, A.03.00

Integ BW

Specifies the range of integration used in calculating the power in the channel. The integration bandwidth (IBW) is displayed on the trace as two markers connected by an arrow.

Key Path	Meas Setup
Mode	SA, WCDMA, C2K, WIMAX OFDMA, 1xEVDO, DVB-T/H, DTMB (CTTB), ISDB-T, CMMB, LTE, LTETDD, Digital Cable TV, WLAN, LTEAFDD, LTEATDD
Remote Command	<code>[:SENSe] :CHPower:BANDwidth:INTEgration <bandwidth></code> <code>[:SENSe] :CHPower:BANDwidth:INTEgration?</code>
Example	CHP:BAND:INT 10MHz CHP:BAND:INT?
Notes	You must be in the Spectrum Analysis mode, W-CDMA mode, cdma2000 mode, DVB-T/H mode, DTMB (CTTB) mode, ISDB-T mode, CMMB mode, Digital Cable TV mode, LTE mode, LTE TDD mode, WLAN mode, 1xEVDO mode or WIMAX OFDMA mode to use this command. Use <code>:INSTrument:SElect</code> to set the mode.
Dependencies	For MSR/LTE-Advanced FDD/TDD mode, this key is blank. In order to keep backwards compatible with the legacy LTE FDD/TDD, the <code>scpi</code> command is supported in LTE & LTE-A converged application.
Couplings	The minimum value of the span is coupled with the integration bandwidth.
Preset	SA: 2 MHz WCDMA: 5 MHz C2K: 1.23 MHz WIMAX OFDMA: 10 MHz 1xEVDO: 1.23 MHz DVB-T/H: 7.61MHz DTMB (CTTB): 8MHz ISDB-T: 5.6MHz CMMB: 8MHz LTE: 5 MHz LTETDD: 5 MHz Digital Cable TV: 8MHz WLAN: if Radio Std is 802.11a/g(OFDM/DSSS-OFDM): 20 MHz if Radio Std is 802.11b: 25 MHz if Radio Std is 802.11n(20MHz): 20 MHz if Radio Std is 802.11n(40MHz): 40 MHz if Radio Std is 802.11ac (20 MHz): 20 MHz if Radio Std is 802.11ac (40 MHz): 40 MHz if Radio Std is 802.11ac (80 MHz): 80 MHz if Radio Std is 802.11ac (160 MHz): 160 MHz

	if Radio Std is 802.11ac (80 MHz + 80 MHz): 80 MHz
State Saved	Saved in instrument state.
Min	100 Hz
Max	Hardware Maximum Span
Initial S/W Revision	Prior to A.02.00
Modified at S/W Revision	A.02.00, A.03.00, A.14.50

Limits

Accesses the Limits menu that allows you to set up the test limit for channel power or power spectral density.

Key Path	Meas Setup
Initial S/W Revision	A.10.00

Power Limit

If Power Limit is on, Power Limit is used as threshold which can judge whether the real measured channel power can be passed or not. If real measured channel power exceeds Power Limit, channel power test fails, otherwise, it passes. If Power Limit is off, channel power test is always passed.

Key Path	Meas Setup, Limits
Mode	SA, WCDMA, C2K, WIMAX OFDMA, 1xEVDO, LTE, LTETDD, Digital Cable TV, WLAN, LTEAFDD, LTEATDD
Remote Command	:CALCulate:CHPower:LIMit:POWer <ampl> :CALCulate:CHPower:LIMit:POWer? :CALCulate:CHPower:LIMit:POWer:STATe OFF ON 0 1 :CALCulate:CHPower:LIMit:POWer:STATe?
Example	CALC:CHP:LIM:POW 16.00 CALC:CHP:LIM:POW? CALC:CHP:LIM:POW:STAT ON CALC:CHP:LIM:POW:STAT?
Notes	This parameter and PSD Limit can determine Pass/Fail criteria. If ((power limit = On) and (PSD limit= Off)) Pass if (power test passes) Fail if (power test fails) If ((power limit = On) and (PSD limit= On)) Pass if (both power test and PSD test pass) Fail if (either of power test or PSD test fails)

	<p>If ((power limit = Off) and (PSD limit= On)) Pass if (PSD test passes) Fail if (PSD test fails) If ((power limit = Off) and (PSD limit= Off)) Always Pass For MSR mode, this key is blank. For LTE-Advanced FDD/TDD mode, this key is blank. In order to keep backwards compatible with the legacy LTE FDD/TDD, the scpi command is supported in LTE & LTE-A converged application For WLAN 802.11ac (80 MHz + 80 MHz), the power test and the PSD test are performed to both carriers. Which means the power (or PSD) readouts of both carriers should be compared with the power (or PSD) limit individually, and the test passes only when both values are lower than the limit.</p>
Preset	<p>16.00 SA, WCDMA, C2K, WIMAX OFDMA, 1xEVDO, DVB-T/H, DTMB (CTTB), LTE, LTETDD, Digital Cable TV: OFF WLAN: ON</p>
State Saved	Saved in instrument state.
Min	-200.0
Max	200.0
Initial S/W Revision	A.10.00

PSD Limit

If PSD (power spectral density) Limit is ON, PSD Limit is used as threshold which can judge whether the real measured PSD can be passed or not. If real measured PSD exceeds PSD Limit, PSD test fails, otherwise, it passes. If PSD is off, PSD test is always passed.

Key Path	Meas Setup, Limits
Mode	SA, WCDMA, C2K, WIMAX OFDMA, 1xEVDO, LTE, LTETDD, Digital Cable TV, WLAN
Remote Command	<pre>:CALCulate:CHPower:LIMit:PSDensity <real> :CALCulate:CHPower:LIMit:PSDensity? :CALCulate:CHPower:LIMit:PSDensity:STATe OFF ON 0 1 :CALCulate:CHPower:LIMit:PSDensity:STATe?</pre>
Example	<pre>CALC:CHP:LIM:PSD 4.00 CALC:CHP:LIM:PSD? CALC:CHP:LIM:POW:STAT ON CALC:CHP:LIM:POW:STAT?</pre>
Notes	<p>This parameter and Power Limit can determine Pass/Fail criteria. If ((power limit = On) and (PSD limit= Off)) Pass if (power test passes) Fail if (power test fails)</p>

	<p>If ((power limit = On) and (PSD limit= On)) Pass if (both power test and PSD test pass) Fail if (either of power test or PSD test fails) If ((power limit = Off) and (PSD limit= On)) Pass if (PSD test passes) Fail if (PSD test fails) If ((power limit = Off) and (PSD limit= Off)) Always Pass For MSR mode, this key is blank. For LTE-Advanced FDD/TDD mode, this key is blank. For WLAN 802.11ac (80 MHz + 80 MHz), the power test and the PSD test are performed to both carriers. Which means the PSD (or power) readouts of both carriers should be compared with the PSD (or power) limit individually, and the test passes only when both values are lower than the limit.</p>
Couplings	The value is automatically converted when PSD Unit is changed.
Preset	4.00 SA, WCDMA, C2K, WIMAX OFDMA, 1Xevdo, LTE, LTETDD, Digital Cable TV: OFF WLAN: ON
State Saved	Saved in instrument state.
Min	-200.0
Max	200.0
Initial S/W Revision	A.10.00

Power Limit Fail (remote command only)

The command is query only and used to query if power test passes or fails.

Remote Command	:CALCulate:CHPower:LIMit:POWer:FAIL?
Example	CALC:CHP:LIM:POW:FAIL?
Notes	<p>This command is query only. When Power Limit is off, the returned value is always 0 (pass). When Power Limit is on, the returned value is 0(pass) while power test passes and 1(fail) while power test fails. In MSR, LTE-Advanced FDD/TDD mode, this feature is not supported. In order to keep backwards compatible with the legacy LTE FDD/TDD, the scpi command is supported in LTE & LTE-A converged application.</p>
Initial S/W Revision	A.10.00

PSD Limit Fail (remote command only)

The command is query only and used to query if PSD test passes or fails.

Remote Command	:CALCulate:CHPower:LIMit:PSD:FAIL?
Example	CALC:CHP:LIM:PSD:FAIL?
Notes	This command is query only. When PSD Limit is off, the returned value is always 0 (pass). When PSD Limit is on, the returned value is 0(pass) while PSD test passes and 1(fail) while PSD test fails.
Initial S/W Revision	A.10.00

Meas Preset

Restores all the measurement parameters to their default values.

Key Path	Meas Setup
Mode	SA, WCDMA, C2K, WIMAX OFDMA, 1xEVDO, DVB-T/H, DTMB (CTTB), ISDB-T, CMMB, LTE, LTETDD, Digital Cable TV, WLAN, MSR, LTEAFDD, LTEATDD
Remote Command	:CONFigure:CHPower
Example	CONF:CHP
Initial S/W Revision	Prior to A.02.00
Modified at S/W Revision	A.02.00, A.03.00

PSD Unit

Sets the unit bandwidth for Power Spectral Density. The available units are dBm/Hz and dBm/MHz.

Key Path	Meas Setup
Mode	SA, WCDMA, WIMAX OFDMA, 1xEVDO, DVB-T/H, DTMB (CTTB), LTE, LTETDD, Digital Cable TV, WLAN, MSR, LTEAFDD, LTEATDD
Remote Command	:UNIT:CHPower:POWer:PSD DBMHZ DBMMHZ :UNIT:CHPower:POWer:PSD?
Example	UNIT:CHP:POW:PSD DBMMHZ UNIT:CHP:POW:PSD?
Couplings	When the PSD unit is changed, the PSD result of the "MEAS READ FETCH:CHP1?" is also changed by the PSD unit basis (in either dBm/Hz or dBm/MHz).
Preset	DBMHZ WLAN: DBMMHZ
State Saved	Saved in instrument state.
Range	dBm/Hz dBm/MHz

8 Channel Power Measurement
Meas Setup

Initial S/W Revision	Prior to A.02.00
Modified at S/W Revision	A.02.00, A.03.00

Mode

See "Mode" on page 162

Mode Preset

Returns the active mode to a known state.

Mode Preset does the following for the currently active mode:

- Aborts the currently running measurement.
- Brings up the default menu for the mode, with no active function.
- Sets measurement Global settings to their preset values for the active mode only.
- Activates the default measurement.
- Brings up the default menu for the mode.
- Clears the input and output buffers.
- Sets Status Byte to 0.

Mode Preset does not:

- Cause a mode switch
- Affect mode persistent settings
- Affect system settings
- See "[How-To Preset](#)" on page 353 for more information.

Key Path	Front-panel key
Remote Command	:SYSTem:PRESet
Example	:SYST:PRES
Notes	*RST is preferred over :SYST:PRES for remote operation. *RST does a Mode Preset, as done by the :SYST:PRES command, and it sets the measurement mode to Single measurement rather than Continuous for optimal remote control throughput. Clears all pending OPC bits. The Status Byte is set to 0.
Couplings	A Mode Preset aborts the currently running measurement, activates the default measurement, and gets the mode to a consistent state with all of the default couplings set.
Backwards Compatibility Notes	In the X-Series, the legacy "Factory Preset" has been replaced with Mode Preset, which only presets the currently active mode, not the entire instrument. In the X-Series, the way to preset the entire instrument is by using System, Restore System Defaults All, which behaves essentially the same way as restore System Defaults does on ESA and PSA. There is also no "Preset Type" as there is on the PSA. There is a green Mode Preset front-panel key that does a Mode Preset and a white-with-green-letters User Preset front-panel key that does a User Preset. The old PRESet:TYPE command is ignored (without generating an error), and SYST:PRES without a parameter does a Mode Preset, which should cover most backward code compatibility issues. The settings and correction data under the Input/Output front-panel key (examples: Input Z Corr, Ext Amp Gain, etc.) are no longer part of any Mode, so they will not be preset by a Mode Preset. They are preset using Restore Input/Output Defaults, Restore System Defaults All. Note that because User Preset does a Recall State, and all of these settings are saved in State, they ARE recalled when using

	User Preset.
Initial S/W Revision	Prior to A.02.00

How-To Preset

The table below shows all possible presets, their corresponding SCPI commands and front-panel access (key paths). Instrument settings depend on the current measurement context. Some settings are local to the current measurement, some are global (common) across all the measurements in the current mode, and some are global to all the available modes. In a similar way, restoring the settings to their preset state can be done within the different contexts.

Auto Couple - is a measurement local key. It sets all Auto/Man parameter couplings in the measurement to Auto. Any Auto/Man selection that is local to other measurements in the mode will not be affected.

Meas Preset - is a measurement local key. Meas Preset resets all the variables local to the current measurement except the persistent ones.

Mode Preset - resets all the current mode's measurement local and measurement global variables except the persistent ones.

Restore Mode Defaults - resets ALL the Mode variables (and all the Meas global and Meas local variables), including the persistent ones.

Type Of Preset	SCPI Command	Front Panel Access
Auto Couple	:COUPle ALL	Auto Couple front-panel key
Meas Preset	:CONFigure:<Measurement>	Meas Setup Menu
Mode Preset	:SYSTem:PRESet	Mode Preset (green key)
Restore Mode Defaults	:INSTrument:DEFault	Mode Setup Menu
Restore All Mode Defaults	:SYSTem:DEFault MODEs	System Menu; Restore System Default Menu
*RST	*RST	not possible (Mode Preset with Single)
Restore Input/Output Defaults	:SYSTem:DEFault INPut	System Menu; Restore System Default Menu
Restore Power On Defaults	:SYSTem:DEFault PON	System Menu; Restore System Default Menu
Restore Alignment Defaults	:SYSTem:DEFault ALIGn	System Menu; Restore System Default Menu
Restore Miscellaneous Defaults	:SYSTem:DEFault MISC	System Menu; Restore System Default Menu
Restore All System Defaults	:SYSTem:DEFault [ALL] :SYSTem:PRESet:PERSistent	System Menu; Restore System Default Menu
User Preset	:SYSTem:PRESet:USER	User Preset Menu
User Preset All Modes	:SYSTem:PRESet:USER:ALL	User Preset Menu

8 Channel Power Measurement
Mode Preset

Power On Mode Preset	:SYSTem:PON:TYPE MODE	System Menu
Power On User Preset	:SYSTem:PON:TYPE USER	System Menu
Power On Last State	:SYSTem:PON:TYPE LAST	System Menu

Mode Setup

See "[Mode Setup](#)" on page 181

Peak Search

Places the selected marker on the trace point with the maximum y-axis value. Pressing Peak Search with the selected marker Off causes the selected marker to be set to Normal, then a peak search is immediately performed.

Key Path	Front panel key
Mode	SA, WCDMA, C2K, WIMAX OFDMA, 1xEVDO, DVB-T/H, DTMB (CTTB), ISDB-T, CMMB, LTE, LTETDD, Digital Cable TV, WLAN, MSR, LTEAFDD, LTEATDD
Remote Command	:CALCulate:CHPower:MARKer[1] 2 ... 12:MAXimum
Example	CALC:CHP:MARK2:MAX
Initial S/W Revision	Prior to A.02.00
Modified at S/W Revision	A.02.00, A.03.00

Print

See "Print " on page 188

Quick Save

The Quick Save front-panel key repeats the most recent save that was performed from the Save menu, with the following exceptions:

- Register saves are not remembered as Saves for the purpose of the Quick Save function
- If the current measurement does not support the last non-register save that was performed, an informational message is generated, “File type not supported for this measurement”

Quick Save repeats the last type of qualified save (that is, a save qualified by the above criteria) in the last save directory by creating a unique filename using the Auto File Naming algorithm described below.

If Quick Save is pressed after startup and before any qualified Save has been performed, the Quick Save function performs a Screen Image save using the current settings for Screen Image saves (current theme, current directory), which then becomes the “last save” for the purpose of subsequent Quick Saves.

The Auto File Naming feature automatically generates a file name for use when saving a file. The filename consists of a prefix and suffix separated by a dot, as is standard for the Windows® file system. A default prefix exists for each of the available file types:

Type	Default Prefix	Menu
State	State_	(Save/Recall)
Trace + State	State_	(Save/Recall)
Screen	Screen_	(Save/Recall)
Amplitude Corrections	Ampcor_	(Import/Export)
Traces	Trace_	(Import/Export)
Limit Lines	LLine_	(Import/Export)
Measurement Result	MeasR_	(Import/Export)
Capture Buffer	CapBuf_	(Import/Export)

A four digit number is appended to the prefix to create a unique file name. The numbering sequence starts at 0000 within each Mode for each file type and updates incrementally to 9999, then wraps to 0000 again. It remembers where it was through a Mode Preset and when leaving and returning to the Mode. It is reset by Restore Misc Defaults and Restore System Defaults and subsequent running of the instrument application. So, for example, the first auto file name generated for State files is State_0000.state. The next is State_0001, and so forth.

One of the key features of Auto File Name is that we guarantee that the Auto File Name will never conflict with an existing file. The algorithm looks for the next available number. If it gets to 9999, then it looks for holes. If it find no holes, that is no more numbers are available, it gives an error.

For example, if when we get to State_0010.state there is already a State_0010.state file in the current directory, it advances the counter to State_0011.state to ensure that no conflict will exist (and then it verifies that State_0011.state also does not exist in the current directory and advances again if it does, and so forth).

If you enter a file name for a given file type, then the prefix becomes the filename you entered instead of the default prefix, followed by an underscore. The last four letters (the suffix) are the 4-digit number.

For example, if you save a measurement results file as “fred.csv”, then the next auto file name chosen for a measurement results save will be fred_0000.csv.

NOTE

Although 0000 is used in the example above, the number that is used is actually the current number in the Meas Results sequence, that is, the number that would have been used if you had not entered your own file name.

NOTE

If the filename you entered ends with _dddd, where d=any number, making it look just like an auto file name, then the next auto file name picks up where you left off with the suffix being dddd + 1.

Key Path	Front-panel key
Notes	No remote command for this key specifically.
Initial S/W Revision	Prior to A.02.00

Recall

The Recall menu lets you choose what you want to recall, and where you want to recall it from. Among the types of files you can recall are **States and Traces**. In addition, an Import (Data) option lets you recall a number of data types stored in CSV files (as used by Excel and other spreadsheet programs).

NOTE

In products that run multiple instances of the X-Series Application, all instances share the same register and file location where you want to recall from.

The default paths for Recall are data type dependent and are the same as for the Save key.

Key Path	Front-panel key
Notes	<p>No remote command for this key specifically, but the :MMEM:LOAD command is available for specific file types. An example is :MMEM:LOAD:STATe <filename>.</p> <p>If you try to recall a State file for a mode that is not licensed or not available in the instrument, an error message will occur and the state will not change.</p>
Backwards Compatibility Notes	<p>In legacy analyzers, it was possible to load a state without affecting the trace data, limit lines or correction data. Similarly (since User Preset is actually loading a state), it was possible to do a User Preset without affecting the trace data, limit lines or correction data.</p> <p>In the X-Series, "state" always includes all of this data; so whenever state is loaded, all of the traces, limit lines and corrections are affected. Although this differs from previous behavior, it is desirable behavior, and should not cause adverse issues for users.</p>
Backwards Compatibility Notes	<p>Recall for the X-Series supports backward compatibility in the sense that you can recall a state file from any X-Series model number and any version of X-Series software. This is only possible if part of the recalling process goes through a limiting step after recalling the mode settings, at least for settings that may vary with version number, model number, option and license differences. If you try to recall a state file onto an instrument with less capability than what was available on the instrument during the save, the recall will ignore the state it doesn't support and it will limit the recalled setting to what it allows.</p> <p>Example: if the saved state includes preamp ON, but the recalling instrument does not have a preamp; the preamp is limited to OFF. Conversely, if you save a state without a preamp, the preamp is OFF in the state file. When this saved file is recalled on an instrument with a licensed preamp, the preamp is changed to OFF. Another example is if the saved state has center frequency set to 20 GHz, but the instrument recalling the saved state is a different model and only supports 13.5 GHz. In this case, the center frequency is limited along with any other frequency based settings. Since the center frequency can't be preserved in this case, the recall limiting tries to at least preserve span to keep the measurement setup as intact as possible.</p> <p>It may be appropriate to issue a warning if the state is limited on the recall; warnings do not go out to SCPI so this would only affect the manual user.</p> <p>Note that there is no state file compatibility outside of the X-Series. For example, you cannot recall a state file from ESA or PSA.</p>
Initial S/W Revision	Prior to A.02.00

State

The Recall State menu lets you choose a register or file from which to recall the state.

The content of a state file includes all of the settings and data required to return the analyzer as closely as possible to the Mode it was in, with the exact settings that were in place, when the save occurred. The Mode settings in each state file include the settings that are affected by Mode Preset, as well as the additional settings affected by Restore Mode Defaults; all of the Mode's settings. In addition, all of the settings of the Input/Output system are included, even though they are outside of the Mode's state, because they are needed to restore the complete setup. Persistent System settings (for example, GPIB address) are not affected by either a Mode Preset or Restore Mode Defaults, nor are they included in a saved State file.

Since each state file is only for one Mode, the settings for other Modes are unaffected when it is loaded. Recall State will cause a mode switch if the state being recalled is not from the current active mode.

After the recall completes, the message "File <filename> recalled" or "Recalled State Register <register number>" is displayed.

For rapid recalls, the State menu lists 16 registers that you can choose from to recall. Pressing a Register key initiates the recall. You can also select a file from which to recall.

The default path for all State Files is:

My Documents\<<mode name>\state

where <mode name> is the parameter used to select the mode with the INST:SEL command (for example, SA for the Spectrum Analyzer).

See ["More Information" on page 362](#).

Key Path	Recall
Mode	All
Remote Command	:MMEMory:LOAD:STATe <filename>
Example	:MMEM:LOAD:STAT "myState.state" This recalls the file myState.state on the default path
Example	MMEM:LOAD:STAT "MyStateFile.state" This loads the state file data (on the default file directory path) into the instrument state.
Notes	<p>When you pick a file to recall, the analyzer first verifies that the file is recallable in the current instrument by checking the software version and model number of the instrument. If everything matches, a full recall proceeds by aborting the currently running measurement, clearing any pending operations, and then loading the State from the saved state file. You can open state files from any mode, so recalling a State file switches to the mode that was active when the save occurred. After switching to the mode of the saved state file, mode settings and data (if any for the mode) are loaded with values from the saved file. The saved measurement of the mode becomes the newly active measurement and the data relevant to the measurement (if there is any) is recalled.</p> <ul style="list-style-type: none"> • If there is a mismatch between file version or model number or instrument version or model number, the recall function tries to recall as much as possible and returns a warning message. It may limit settings that differ based on model number, licensing or version number. <p>After recalling the state, the Recall State function does the following:</p> <ul style="list-style-type: none"> • Makes the saved measurement for the mode the active measurement. • Clears the input and output buffers. • Status Byte is set to 0.

	<ul style="list-style-type: none"> • Executes a *CLS <p>If the file specified is empty an error is generated. If the specified file does not exist, another error is generated. If there is a mismatch between the file and the proper file type, an error is generated. If there is a mismatch between file version or model number or instrument version or model number, a warning is displayed. Then it returns to the State menu and File Open dialog goes away.</p> <p>After the Recall, the analyzer exits the Recall menu and returns to the previous menu.</p>
Backwards Compatibility SCPI	:MMEMory:LOAD:STATe 1,<filename>
Initial S/W Revision	Prior to A.02.00

More Information

In measurements that support saving Traces, for example, Swept SA, the Trace data is saved along with the State in the State file. When recalling the State, the Trace data is recalled as well. Traces are recalled exactly as they were stored, including the writing mode and update and display modes. If a Trace was updating and visible when the State was saved, it will come back updating and visible, and its data will be rewritten right away. When you use State to save and recall traces, any trace whose data must be preserved should be placed in View or Blank mode before saving.

The following table describes the Trace Save and Recall possibilities:

You want to recall state and one trace's data, leaving other traces unaffected.	Save Trace+State from 1 trace. Make sure that no other traces are updating (they should all be in View or Blank mode) when the save is performed.	On Recall, specify the trace you want to load the one trace's data into. This trace will load in View. All other traces' data will be unaffected, although their trace mode will be as it was when the state save was performed.
You want to recall all traces	Save Trace+State from ALL traces.	On Recall, all traces will come back in View (or Blank if they were in Blank or Background when saved)
You want all traces to load exactly as they were when saved.	Save State	On recall, all traces' mode and data will be exactly as they were when saved. Any traces that were updating will have their data immediately overwritten.

From File...

When you press "From File", the analyzer brings up a Windows dialog and a menu entitled "File Open." This menu allows you to navigate to the various fields in the Windows dialog without using a keyboard or mouse. The Tab and Arrow keys can also be used for dialog navigation.

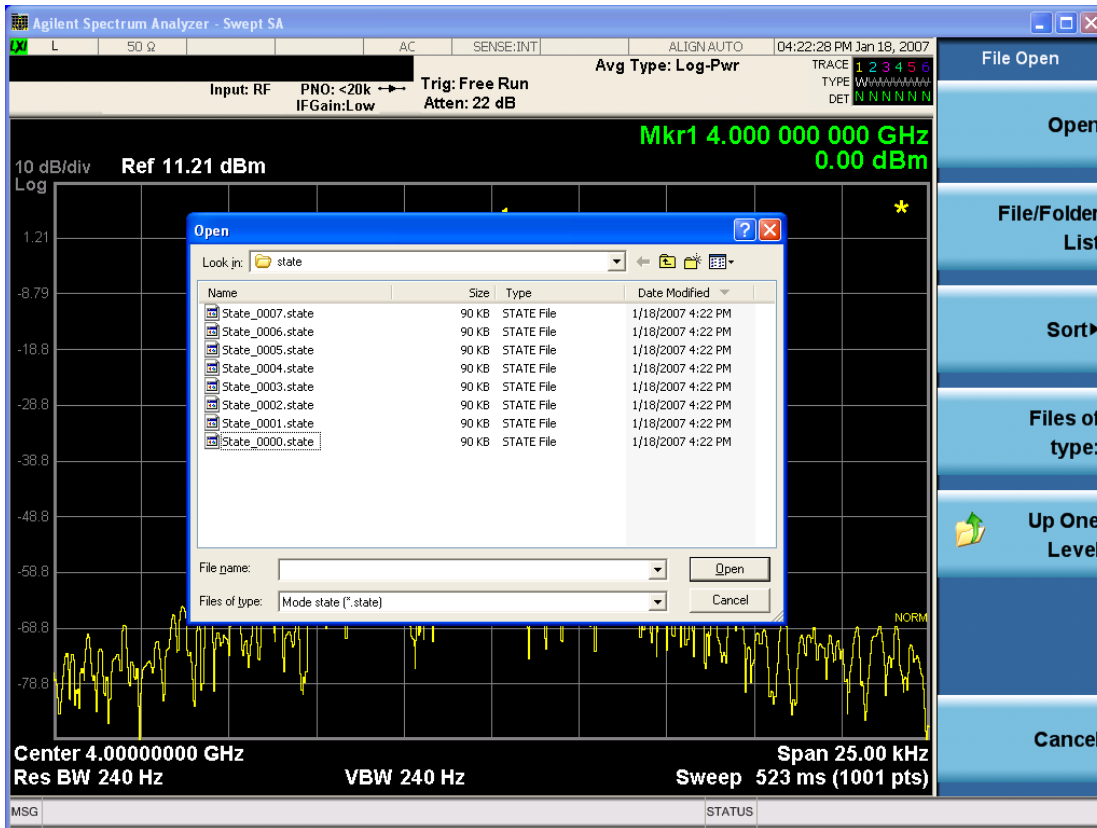

Listed below are the functions of the various fields in the dialog, and the corresponding softkeys:

Open

Performs the recall of the specified file. While the recall is being performed, the floppy icon appears briefly in the Meas bar.

File/Folder List

Enables you to navigate to the center of the dialog that contains the list of files and folders. Once here you can get information about the file and use the tab keys to navigate to the other fields in the dialog, such as Look In.

Look In

The Look In field shows the path from which the file will be recalled and allows you to change the path using the up and down arrow keys to navigate to other paths; the Enter key to open a directory; and the Backspace key to go back one directory. The **Look In field** first uses the last path from the Save As dialog **Save In:** path for that same file type. There is no softkey for directly navigating to the Look In field, but you can use the left tab to get here from the File/Folder List.

User specified paths are remembered when you leave and return to a Mode and are reset back to the default using Restore Mode Defaults.

Sort

Accesses a menu that enables you to sort the files within the File Open dialog. Only one sorting type can be selected at a time and the sorting happens immediately. The sorting types are By Date, By Name, By extension, and By Size.

Files of Type

This field shows the file suffix for the type of file you have selected to recall. For example, if you navigated here while recalling State, "Mode state (*.state)" is in the field. If you navigated here while recalling Trace, ""Mode state (*.trace)" is in the field. If you navigated here while importing a trace data file, "Trace Data (*.csv)" is in the field. For some file types, there is more than one choice in the dropdown menu, which you can select by using the up and down arrow keys and Enter.

Up One Level

This key corresponds to the icon of a folder with the up arrow that is in the tool bar of the dialog. When pressed, it causes the file and folder list to navigate up one level in the directory structure. The Backspace key does the same thing.

Cancel

This key corresponds to the Cancel selection in the dialog. It causes the current **Open** request to be cancelled. The ESC key does the same thing.

Key Path	Recall, State
Notes	Brings up the Open dialog for recalling a State Save Type
Initial S/W Revision	Prior to A.02.00

Edit Register Names

You may enter a custom name on any of the Register keys, to help you remember what you are using that state to save. To do this, press the Edit Register Names key, choose the register whose name you wish to edit, and then enter the desired label using the Alpha Editor or an external PC keyboard.

The maximum number of characters that can be added is 30. In most cases, 30 characters will fit on two lines of the key.

For more information and the SCPI command, see Edit Register Names under the Save, State function.

Key Path	Recall, State
Mode	All
Dependencies	N9060A-7FP or N9060B-2FP license required to edit the register names. When the feature is not licensed, sending the SCPI command generates an error, -221, "Settings conflict;Option not available"
Initial S/W Revision	A.11.00

Register 1 thru Register 16

Selecting any one of these register keys causes the State of the mode from the specified Register to be recalled. Each of the register keys annotates whether it is empty or at what date and time it was last

modified. In addition, you can use the Edit Register Names key under Save, State to enter custom names for each register.

NOTE

In products that run multiple instances of the X-Series Application, recalling the same register name on each instance is a way to share setups between the instances.

Registers are shared by all modes, so recalling from any one of the registers will cause a mode switch to the mode that was active when the save to the Register occurred.

Although these 16 registers are the only registers available from the front panel, there are 128 state registers available in the instrument. Registers 17–128 are only available from the SCPI interface, using the *RCL command.

After the recall completes, the message "Register <register number> recalled" appears in the message bar. If you are in the Spectrum Analyzer Mode, and you are recalling a register that was saved in the Spectrum Analyzer Mode, then after the recall, you will still be in the Recall Register menu. If the Recall causes you to switch modes, then after the Recall, you will be in the Frequency menu.

If a requested register is empty an error is generated.

Key Path	Recall, State
Example	*RCL 1
Range	1–16 from front panel, 1–128 from SCPI
Readback	Date and time with seconds resolution are displayed on the key OR A custom name of up to 30 characters entered using the Save, State, Edit Register Names key OR “(empty)” if no prior save operation has been performed to this register.
Initial S/W Revision	Prior to A.02.00
Modified at S/W Revision	Prior to A.11.00

Register 1 thru Register 16

Selecting any one of these register keys causes the State of the mode from the specified Register to be recalled. Each of the register keys annotates whether it is empty or at what date and time it was last modified. In addition, you can use the Edit Register Names key under Save, State to enter custom names for each register.

NOTE

In products that run multiple instances of the X-Series Application, recalling the same register name on each instance is a way to share setups between the instances.

Registers are shared by all modes, so recalling from any one of the registers will cause a mode switch to the mode that was active when the save to the Register occurred.

Although these 16 registers are the only registers available from the front panel, there are 128 state registers available in the instrument. Registers 17–128 are only available from the SCPI interface, using the *RCL command.

After the recall completes, the message "Register <register number> recalled" appears in the message bar. If you are in the Spectrum Analyzer Mode, and you are recalling a register that was saved in the Spectrum Analyzer Mode, then after the recall, you will still be in the Recall Register menu. If the Recall causes you to switch modes, then after the Recall, you will be in the Frequency menu.

If a requested register is empty an error is generated.

Key Path	Recall, State
Example	*RCL 1
Range	1-16 from front panel, 1-128 from SCPI
Readback	Date and time with seconds resolution are displayed on the key OR A custom name of up to 30 characters entered using the Save, State,Edit Register Names key OR "(empty)" if no prior save operation has been performed to this register.
Initial S/W Revision	Prior to A.02.00
Modified at S/W Revision	Prior to A.11.00

Sequences

These keys allow you to import a Tab separated or .txt file that will automatically setup all the parameters required for building a Sequence. The parameters will automatically be loaded into the Stated Sequencer.

Once selected, in order to import the selected Sequence Type you must select the Open key in the Source Sequence menu.

Key Path	Recall, Sequences
Mode	All
Remote Command	:MMEMory:LOAD:SEQuences: SLISt ALISt SAALISt "MySequence.txt"
Example	:MMEM:LOAD:SEQ:SLIS "MySequence.txt"
Notes	Available file types are: –CSV (Comma delimited) (*.csv) –Text (Tab delimited) (*.txt)
Initial S/W Revision	A.05.00

Source Sequence

The list of parameters, that configure steps, that makes up a sequence for the Source.

The Source sequence is a sequence of flexible configurable steps that can be set anywhere in the instruments frequency range.

Key Path	Recall,Sequences
----------	------------------

Example	:MMEM:LOAD:SEQ:SLIS "MySequence.txt"
Dependencies	Only available in XOBT
Initial S/W Revision	A.05.00

Open...

When you press "Open", the analyzer brings up a Windows dialog and a menu entitled "File Open." This menu allows you to navigate to the various fields in the Windows dialog without using a keyboard or mouse. The Tab and Arrow keys can also be used for dialog navigation.

See "[From File...](#)" on page 2060 in Recall, State, for a full description of this dialog and menu.

Key Path	Recall, Data
Notes	The key location is mode-dependent and will vary. Brings up Open dialog for recalling a <mode specific> Save Type
Initial S/W Revision	Prior to A.02.00

Data (Import)

Importing a data file loads data that was previously saved from the current measurement or from other measurements and/or modes that produce compatible data files. The Import Menu only contains Data Types that are supported by the current measurement.

Since the commonly exported data files are in .csv format, the data can be edited by the user prior to importing. This allows you to export a data file, manipulate the data in Excel (the most common PC Application for manipulating .csv files) and then import it.

Importing Data loads measurement data from the specified file into the specified or default destination, depending on the data type selected. Selecting an Import Data menu key will not actually cause the importing to occur, since the analyzer still needs to know from where to get the data. Pressing the Open key in this menu brings up the Open dialog and Open menu that provides you with the options from where to recall the data. Once a filename has been selected or entered in the Open menu, the recall occurs as soon as the Open button is pressed.

Key Path	Recall
Mode	All
Notes	The menu is built from whatever data types are available for the mode. Some keys will be missing completely, so the key locations in the sub-menu will vary. No SCPI command directly controls the Data Type that this key controls. The Data Type is included in the MMEM:LOAD commands.
Dependencies	If a file type is not used by a certain measurement, it is grayed out for that measurement. The key for a file type will not show at all if there are no measurements in the Mode that support it.
Preset	Is not affected by Preset or shutdown, but is reset during Restore Mode Defaults

Readback	The data type that is currently selected
Initial S/W Revision	Prior to A.02.00

Capture Buffer

Capture buffer functionality is available only in Code Domain and Modulation Accuracy measurements. The captured data is raw data which is not processed.

Key Path	Recall, Data
Mode	CDMA2000
Example	MMEM:LOAD:CAPT "MyCaptureData.bin" This loads the file of capture data (on the default file directory path) into the instrument.
Dependencies	Capture buffer data is only available for Code Domain and Modulation Accuracy measurement. In other measurements, this key is grayed out.

Open...

When you press "Open", the analyzer brings up a Windows dialog and a menu entitled "File Open." This menu allows you to navigate to the various fields in the Windows dialog without using a keyboard or mouse. The Tab and Arrow keys can also be used for dialog navigation.

See "[From File...](#)" on page 2060 in Recall, State, for a full description of this dialog and menu.

Key Path	Recall, Data
Notes	The key location is mode-dependent and will vary. Brings up Open dialog for recalling a <mode specific> Save Type
Initial S/W Revision	Prior to A.02.00

Restart

The Restart function restarts the current sweep, or measurement, or set of averaged/held sweeps or measurements. If you are Paused, pressing Restart does a Resume.

The Restart function is accessed in several ways:

- Pressing the Restart key
- Sending the remote command INIT:IMMEDIATE
- Sending the remote command INIT:RESTART

See "[More Information](#)" on page 369

Key Path	Front-panel key
Remote Command	:INITiate[:IMMEDIATE] :INITiate:RESTART
Example	:INIT:IMM :INIT:REST
Notes	:INITiate:RESTART and :INITiate:IMMEDIATE perform exactly the same function.
Couplings	Resets average/hold count k. For the first sweep overwrites all active (update=on) traces with new current data. For application modes, it resets other parameters as required by the measurement.
Status Bits/OPC dependencies	This is an Overlapped command. The STATUS:OPERation register bits 0 through 8 are cleared. The STATUS:QUESTIONable register bit 9 (INTEgrity sum) is cleared. The SWEEPING bit is set. The MEASURING bit is set.
Backwards Compatibility Notes	For Spectrum Analysis mode in ESA and PSA, the Restart hardkey and the INITiate:RESTART command restart trace averages (displayed average count reset to 1) for a trace in Clear Write, but did not restart Max Hold and Min Hold. In the X-Series, the Restart hardkey and the INITiate:RESTART command restart not only Trace Average, but MaxHold and MinHold traces as well. For wireless comms modes in ESA and PSA, the Restart hardkey and the INITiate:RESTART command restart every measurement, which includes all traces and numeric results. There is no change to this operation.
Initial S/W Revision	Prior to A.02.00

More Information

The **Restart** function first aborts the current sweep/measurement as quickly as possible. It then resets the sweep and trigger systems, sets up the measurement and initiates a new data measurement sequence with a new data acquisition (sweep) taken once the trigger condition is met.

If the analyzer is in the process of aligning when **Restart** is executed, the alignment finishes before the restart function is performed.

Even when set for Single operation, multiple sweeps may be taken when Restart is pressed (for example, when averaging/holding is on). Thus when we say that **Restart** "restarts a measurement," we may mean:

- It restarts the current sweep
- It restarts the current measurement
- It restarts the current set of sweeps if any trace is in Trace Average, Max Hold or Min Hold
- It restarts the current set of measurements if Averaging, or Max Hold, or Min Hold is on for the measurement
- depending on the current settings.

With **Average/Hold Number** (in **Meas Setup** menu) set to 1, or Averaging off, or no trace in Trace Average or Hold, a single sweep is equivalent to a single measurement. A single sweep is taken after the trigger condition is met; and the analyzer stops sweeping once that sweep has completed. However, with **Average/Hold Number** >1 and at least one trace set to **Trace Average, Max Hold, or Min Hold (SA Measurement)** or **Averaging on (most other measurements)**, multiple sweeps/data acquisitions are taken for a single measurement. The trigger condition must be met prior to each sweep. The sweep is stopped when the average count k equals the number N set for **Average/Hold Number**. A measurement average usually applies to all traces, marker results, and numeric results; but sometimes it only applies to the numeric results.

Once the full set of sweeps has been taken, the analyzer will go to idle state. To take one more sweep without resetting the average count, increment the average count by 1, by pressing the step up key while **Average/Hold Number** is the active function, or sending the remote command `CALC:AVER:TCON UP`.

Save

The Save menu lets you choose what you want to save and where you want to save it. Among the types of files you can save are **States**, **Traces**, and **Screen Images**. In addition, an Export (Data) option lets you save a number of data types as CSV files for easy import into Excel and other spreadsheet programs.

Key Path	Front-panel key
Mode	All
Notes	No remote command for this key specifically, but the :MMEM:STORe command is available for specific file types. An example is :MMEM:STOR:STATe <filename>.
Initial S/W Revision	Prior to A.02.00

State

The Save State menu lets you choose a register or file for saving the state.

NOTE

In products that run multiple instances of the X-Series Application, all instances share the same register and file location where you want to save the state.

The content of a state file includes all of the settings and data required to return the analyzer as closely as possible to the Mode it was in, with the exact settings which were in place, when the save occurred. The Mode settings in each state file include the settings that are affected by Mode Preset, as well as the additional settings affected by Restore Mode Defaults; all of the Mode's settings. In addition, all of the settings of the Input/Output system are included, even though they are outside of the Mode's state, because they are needed to restore the complete setup. Persistent System settings (for example, Verbose SCPI) are not affected by either Mode Preset or Restore Mode Defaults, nor are they included in a saved State file.

After the save completes, the message "File <filename> saved" or "State Register <register number> saved" is displayed.

For rapid saving, the State menu lists 16 registers to save to. Pressing a Register key initiates the save. You can also select a file to save to.

The default path for all State Files is:

My Documents\<<mode name>\state

where <mode name> is the parameter used to select the mode with the INST:SEL command (for example, SA for the Spectrum Analyzer).

Key Path	Save
Mode	All
Remote Command	:MMEMory:STORe:STATe <filename>
Example	MMEM:STOR:STATe "MyStateFile.state" This stores the current instrument state data in the file MyStateFile.state in the default directory.
Notes	Both single and double quotes are supported for any filename parameter over remote.

After saving to a register, that register's menu key is updated with the date the time, unless a custom label has been entered for that key.

After saving to a register, you remain in the Save State menu, so that you can see the Register key update. After saving to a file, the analyzer automatically returns to the previous menu and any Save As dialog goes away.

Backwards :MMEMory:STORE:STATE 1,<filename>

Compatibility SCPI For backwards compatibility, the above syntax is supported. The "1" is simply ignored. The command is sequential.

Initial S/W Revision Prior to A.02.00

To File . . .

When you press "To File", the analyzer brings up a Windows dialog and a menu entitled "Save As." This menu allows you to navigate to the various fields in the Windows dialog without using a keyboard or mouse. The Tab and Arrow keys can also be used for dialog navigation.

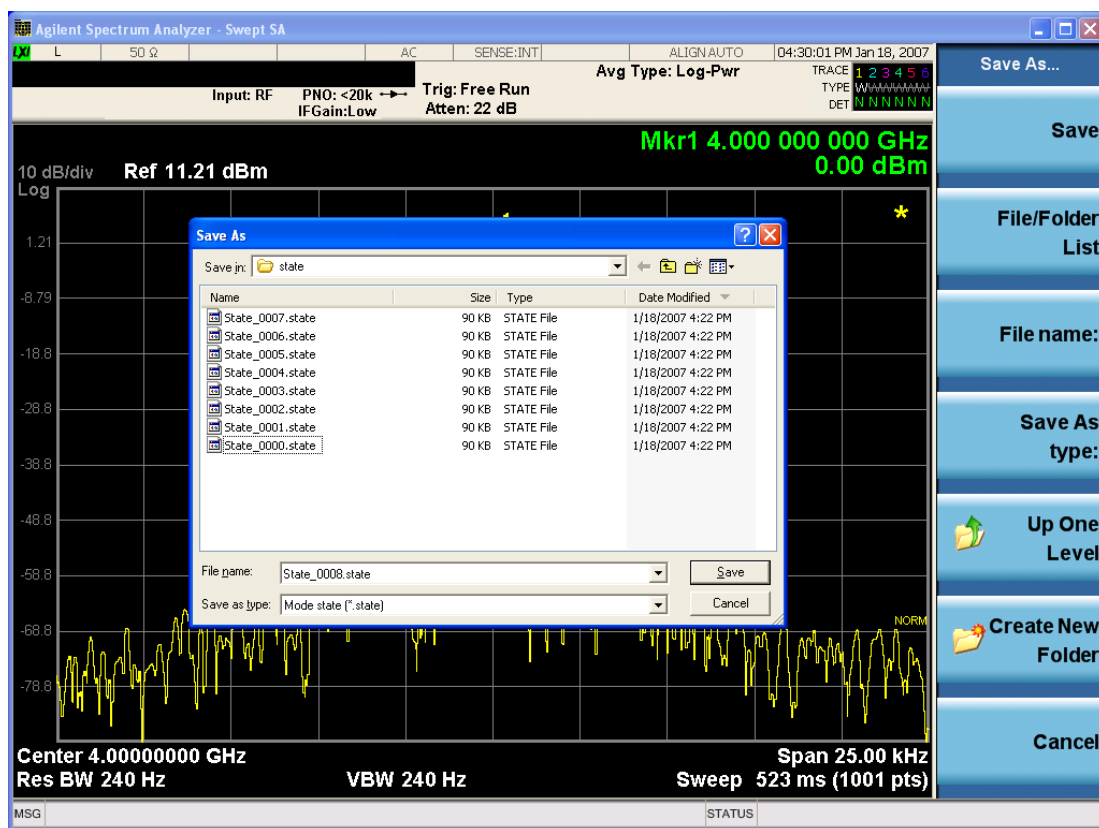

The Listed below

are the functions of the various fields in the dialog, and the corresponding softkeys:

Save

Performs the save to the specified file of the selected type. If the file already exists, a dialog will appear that allows you to replace the existing file by selecting OK, or you can Cancel the request. If you select OK,

the file will be overwritten. Using the C: drive is strongly discouraged, since it runs the risk of being overwritten during an instrument software upgrade.

While the save is being performed, the floppy icon appears briefly in the Meas bar.

File/Folder List

Enables you to navigate to the center of the dialog that contains the list of files and folders. Once here you can get information about the file and use the tab keys to navigate to the other fields in the dialog, such as Save In.

Save In

The Save In field shows the path to which the file will be saved and allows you to change the path using the up and down arrow keys to navigate to other paths; the Enter key to open a directory; and the Backspace key to go back one directory. The **Save In field** defaults to the default path for this type of file and remembers the last path you used to save this type of file. There is no softkey for directly navigating to the Save In field but you can use left tab to get here from the File/Folder List.

User specified paths are remembered when you leave and return to a Mode and are reset back to the default using Restore Mode Defaults.

File Name

The File Name field is initially loaded with an automatically generated filename specific to the appropriate Save Type. The automatically generated filename is guaranteed not to conflict with any filename currently in the directory. You may replace or modify this filename using the File Name key. See the ["Quick Save " on page 2056](#) documentation for more on the automatic file naming algorithm.

When you press the File Name key the analyzer displays the Alpha Editor. Use the knob to choose the letter to add and the front-panel Enter key to add the letter to the file name. The BK character moves you back and the FW character moves you forward in the filename. The Select key on the front panel generates a space character. When you are done entering the filename press the Done softkey. This returns back to the **File Open** dialog and menu, but does not cause the save to occur.

Save As Type

This field shows the file suffix for the type of file you have selected to save. For example, if you navigated here while saving State, "Mode state (*.state)" is in the field. If you navigated here from saving Trace, ""Mode state (*.trace)" is in the field. If you navigated here while exporting a trace data file, "Trace Data (*.csv)" is in the field. For some file types, there is more than one choice in the dropdown, which you can select by using the up and down arrow keys and Enter.

Up One Level

This key corresponds to the icon of a folder with the up arrow that is in the tool bar of the dialog. When pressed, it causes the file and folder list to navigate up one level in the directory structure. The Backspace key does the same thing.

Create New Folder

This key corresponds to the icon of a folder with the "*" that is in the tool bar of the dialog. When pressed, a new folder is created in the current directory with the name **New Folder** and you can enter a new folder name using the Alpha Editor.

Cancel

This key corresponds to the Cancel selection in the dialog. It causes the current **Save As** request to be cancelled. The ESC key does the same thing.

Key Path	Save, State
Mode	All
Notes	Brings up Save As dialog for saving a State Save Type
Initial S/W Revision	Prior to A.02.00

Edit Register Names

You may enter a custom name on any of the Register keys, to help you remember what you are using that state to save. To do this, press the Edit Register Names key, choose the register whose name you wish to edit, and then enter the desired label using the Alpha Editor or an external PC keyboard.

The maximum number of characters that can be added is 30. In most cases, 30 characters will fit on two lines of the key.

See ["More Information" on page 374](#)

Key Path	Save, State
Mode	All
Remote Command	:MMEMory:REGister:STATe:LABel <reg number>,"label" :MMEMory:REGister:STATe:LABel? <reg number>
Example	:MMEM:REG:STAT:LAB 1,"my label"
Notes	<reg number> is an integer from 1 to 16. If the SCPI specifies an invalid register number an error message is generated, -222,"Data out of range;Invalid register label number" "label" is a string from 0 to 30 characters in length. If a label exceeds 30 characters, an error message is generated, -150,"String data error;Label clipped to 30 characters" "label" of length 0 erases the custom label and restores the default (time and date) label. E.g.: :MMEM:REG:STAT:LAB 1,""
Dependencies	N9060A-7FP or N9060B-2FP license required to edit the register names. When the feature is not licensed, sending this command generates an error, -221,"Settings conflict;Option not available"
Preset	The names are unaffected by Preset or power cycle but are set to the default label (time and date) on a "Restore System Defaults->Misc"
Initial S/W Revision	A.11.00

More Information

When you edit one of the register names, the time and date field will be replaced by the custom name.

If you delete all the characters in the custom name, it restores the default (time and date).

The register names are stored within the state files, but they are not part of the instrument state; that is, once you have edited a register name, loading a new state will not change that register name. Another

consequence of this is that the names will be persistent through a power cycle. Also, if a named state file is transferred to another analyzer, it will bring its custom name along with it.

If you try to edit the name of an empty register, the analyzer will first save the state to have a file to put the name in. If you load a named state file into an analyzer with older firmware it will ignore the metadata.

The *SAV and *RCL commands will not be affected by the custom register names, nor will the MMEM commands.

Register 1 thru Register 16

Selecting any one of these register menu keys causes the State of the currently active mode to be saved to the specified Register. The registers are provided for rapid saving and recalling, since you do not need to specify a filename or navigate to a file. Each of the register menu keys annotates whether it is empty or at what date and time it was last modified. In addition, you can use the Edit Register Names key to enter custom names for each register.

NOTE

In products that run multiple instances of the X-Series Application, save with different register name if you do not want to overwrite the register of another running instance.

Although these 16 registers are the only registers available from the front panel, there are 128 state registers available in the instrument. Registers 17–128 are only available from the SCPI interface, using the *SAV command.

There is one set of 128 state registers in the instrument, not one set for each Mode. When a state is saved, the Mode it was saved from is saved with it; then when it is recalled, the instrument switches to that Mode.

After the save completes, the corresponding register menu key annotation is updated with the date and time and the message "Register <register number> saved" is displayed.

Key Path	Save, State
Mode	All
Example	*SAV 1
Range	1–16 from front panel, 1–128 from SCPI
Readback	Date and time with seconds resolution are displayed on the key OR A custom name of up to 30 characters entered using the Edit Register Names key OR “(empty)” if no prior save operation has been performed to this register.
Initial S/W Revision	Prior to A.02.00
Modified at S/W Revision	A.11.00

Register 1 thru Register 16

Selecting any one of these register menu keys causes the State of the currently active mode to be saved to the specified Register. The registers are provided for rapid saving and recalling, since you do not need to specify a filename or navigate to a file. Each of the register menu keys annotates whether it is empty or at

what date and time it was last modified. In addition, you can use the Edit Register Names key to enter custom names for each register.

NOTE

In products that run multiple instances of the X-Series Application, save with different register name if you do not want to overwrite the register of another running instance.

Although these 16 registers are the only registers available from the front panel, there are 128 state registers available in the instrument. Registers 17–128 are only available from the SCPI interface, using the *SAV command.

There is one set of 128 state registers in the instrument, not one set for each Mode. When a state is saved, the Mode it was saved from is saved with it; then when it is recalled, the instrument switches to that Mode.

After the save completes, the corresponding register menu key annotation is updated with the date and time and the message "Register <register number> saved" is displayed.

Key Path	Save, State
Mode	All
Example	*SAV 1
Range	1–16 from front panel, 1–128 from SCPI
Readback	Date and time with seconds resolution are displayed on the key OR A custom name of up to 30 characters entered using the Edit Register Names key OR “(empty)” if no prior save operation has been performed to this register.
Initial S/W Revision	Prior to A.02.00
Modified at S/W Revision	A.11.00

Mass Storage Catalog (Remote Command Only)

Key path	SCPI Only
Remote Command	:MMEMory:CATalog? [<directory_name>]
Notes	The string must be a valid logical path. Queries disk usage information (drive capacity, free space available) and obtains a list of files and directories in a specified directory in the following format: <numeric_value>,<numeric_value>,{<file_entry>} It returns two numeric parameters and as many strings as there are files and directories. The first parameter indicates the total amount of storage currently used in bytes. The second parameter indicates the total amount of storage available, also in bytes. The <file_entry> is a string. Each <file_entry> indicates the name, type, and size of one file in the directory list: <file_name>,<file_type>,<file_size> As the windows file system has an extension that indicates file type, <file_type> is always empty. <file_size> provides the size of the file in bytes. For directories, <file_entry> is surrounded by square brackets and both <file_type> and <file_size> are empty
Initial S/W Revision	Prior to A.02.00

Mass Storage Change Directory (Remote Command Only)

Key path	SCPI Only
Remote Command	:MMEMory:CDIRectory [<directory_name>] :MMEMory:CDIRectory?
Notes	The string must be a valid logical path. Changes the default directory for a mass memory file system. The <directory_name> parameter is a string. If no parameter is specified, the directory is set to the *RST value. At *RST, this value is set to the default user data storage area, that is defined as System.Environment.SpecialFolder.Personal. Query returns full path of the default directory.
Initial S/W Revision	Prior to A.02.00

Mass Storage Copy (Remote Command Only)

Key path	SCPI Only
Remote Command	:MMEMory:COPY <string>, <string> [, <string>, <string>]
Notes	The string must be a valid logical path. Copies an existing file to a new file or an existing directory to a new directory. Two forms of parameters are allowed. The first form has two parameters. In this form, the first parameter specifies the source, and the second parameter specifies the destination. The second form has four parameters. In this form, the first and third parameters specify the source. The second and fourth parameters specify the directories. The first pair of parameters specifies the source. The second pair specifies the destination. An error is generated if the source doesn't exist or the destination file already exists. This command will generate an "access denied" error if the destination is a restricted folder (e.g., C:\Windows) and the current user does not have Power User or Administrator privileges.

Mass Storage Device Copy (Remote Command Only)

This command transfers data to/from a file and a peripheral device.

Key path	SCPI Only
Remote Command	:MMEMory:COPY:DEvice <source_string>, <dest_string>
Notes	The strings must be a valid logical path or a valid device keyword. If the dest_string is a device keyword, the data is copied from the source file to the device. If the source_string is a device keyword, the data is copied to the source file from the device. Valid device keywords are: SNS (smart noise source) An error is generated if the file or device is not found.

Mass Storage Delete (Remote Command Only)

Key path	SCPI Only
Remote Command	:MMEMory:DELeTe <file_name>[,<directory_name>]
Notes	The string must be a valid logical path. Removes a file from the specified directory. The <file_name> parameter specifies the file name to be removed. This command will generate an "access denied" error if the file is in a restricted folder (e.g., C:\Windows) and the current user does not have Power User or Administrator privileges.
Initial S/W Revision	Prior to A.02.00

Mass Storage Data (Remote Command Only)

Creates a file containing the specified data OR queries the data from an existing file.

Key path	SCPI Only
Remote Command	:MMEMory:DATA <file_name>, <data> :MMEMory:DATA? <file_name>
Notes	The string must be a valid logical path. The command form is MMEMory:DATA <file_name>,<data>. It loads <data> into the file <file_name>. <data> is in 488.2 block format. <file_name> is string data. The query form is MMEMory:DATA? <file_name> with the response being the associated <data> in block format.
Initial S/W Revision	Prior to A.02.00

Mass Storage Make Directory (Remote Command Only)

Key path	SCPI Only
Remote Command	:MMEMory:MDIRectory <directory_name>
Notes	The string must be a valid logical path. Creates a new directory. The <directory_name> parameter specifies the name to be created. This command will generate an "access denied" error if the new directory would be in a restricted folder (e.g., C:\Windows) and the current user does not have Power User or Administrator privileges.
Initial S/W Revision	Prior to A.02.00

Mass Storage Move (Remote Command Only)

Key path	SCPI Only
Remote Command	:MMEMory:MOVE <string>,<string>[,<string>,<string>]
Notes	The string must be a valid logical path. Moves an existing file to a new file or an existing directory to a new directory.

Two forms of parameters are allowed. The first form has two parameters. In this form, the first parameter specifies the source, and the second parameter specifies the destination.

The second form has four parameters. In this form, the first and third parameters specify the source. The second and fourth parameters specify the directories. The first pair of parameters specifies the source. The second pair specifies the destination. An error is generated if the source doesn't exist or the destination file already exists.

This command will generate an "access denied" error if the destination is a restricted folder (e.g., C:\Windows) and the current user does not have Power User or Administrator privileges.

Initial S/W Revision Prior to A.02.00

Mass Storage Remove Directory (Remote Command Only)

Key path SCPI Only

Remote Command :MMEMory:RDIrectory <directory_name>

Notes The string must be a valid logical path.

Removes a directory. The <directory_name> parameter specifies the directory name to be removed. All files and directories under the specified directory shall also be removed.

This command will generate an "access denied" error if the folder is a restricted folder (e.g., C:\Windows) or is in a restricted folder and the current user does not have Power User or Administrator privileges.

Initial S/W Revision Prior to A.02.00

Mass Storage Determine Removable Media (Remote Command Only)

This command is used to determine if any removable media devices are connected to the instrument. Primarily, these are USB memory devices plugged-in to the front panel or rear panel USB ports. On instruments with PC6 or PC7 CPU's, one SD card slot is available for removable media. The instrument's primary disk drive is not a removable media device.

Key Path SCPI Only

Remote Command :MMEMory:RMEDia:LIST?

Notes The return value will be a string containing a list of partition identifiers which are removable media devices. Each identifier will be separated by a comma. If no removable media is present, an empty string will be returned.

Examples:

One removable device present will result in a return string of "F:".

Two removable devices present will result in a return string of "F:,G:".

No removable devices present will result in a return string of "".

Initial S/W Revision x.15.00

Mass Storage Determine Removable Media Label (Remote Command Only)

This command is used to set or query a removable media device's label.

Key Path	SCPI Only
Remote Command	:MMEMory:RMEDia:LABel <partition>,<string> :MMEMory:RMEDia:LABel? <partition>
Example	MMEM:RMED:LAB "F:","My Device"
Notes	If the <partition> specified does not exist or is not a removable media device the error -252,"Missing Media" will be generated. Setting the removable media label requires Administrative privileges. If the currently logged in user does not have appropriate privileges the error "-221.9900,Settings conflict;Administrator privileges required" is generated.
Initial S/W Revision	x.15.00

Mass Storage Determine Removable Media Write-protect status (Remote Command Only)

This command is used to query a removable media device's write-protect status.

Key Path	SCPI Only
Remote Command	:MMEMory:RMEDia:WPRotect? <partition>
Example	MMEM:RMED:WPR? "F:"
Notes	The return value is 1 if the device is write-protected, and 0 if the device is write-enabled. If the <partition> specified does not exist or is not a removable media device the error -252,"Missing Media" will be generated.
Preset	The return value will be depending on SD card installed.
Initial S/W Revision	x.15.00

Mass Storage Determine Removable Media size (Remote Command Only)

This command is used to query a removable media device's total memory size (not available memory size).

Key Path	SCPI Only
Remote Command	:MMEMory:RMEDia:SIZE? <partition>
Example	MMEM:RMED:SIZE? "F:"
Notes	The return value is integer value in GBytes. Any device which is less than 1 GB will return 0 GB. If the <partition> specified does not exist or is not a removable media device the error -252,"Missing Media" will be generated.
Initial S/W Revision	x.15.00

Sequences

These keys allow you to save a Tab separated or CSV file of the setup parameters required to build a Sequence.

In order to save you must select the Save As button and choose a destination folder.

Key Path	Save, Sequences
Mode	All
Remote Command	:MMEM:STOR:SEquences: SLIST ALIST SAAList SSTep "MySequence.txt"
Example	:MMEM:STOR:SEQ:SLIST "MySequence.txt"
Notes	Available file types are: –CSV (Comma delimited) (*.csv) –Text (Tab delimited) (*.txt)
Initial S/W Revision	A.05.00

Source Sequence

The list of parameters, that configure steps, that makes up a sequence for the Source.

The Source sequence is a sequence of flexible configurable steps that can be set anywhere in the instruments frequency range.

Key Path	Save, Sequences
Example	:MMEM:STOR:SEQ:SLIS "MySequence.txt"
Dependencies	Only available in XOBT
Initial S/W Revision	A.05.00

Save As . . .

This menu lets you select the location where you can save the Sequence. This menu is a standard Windows® dialog with Save As menu keys. The "File Name" field in the Save As dialog is initially loaded with an automatically generated filename specific to the appropriate Save Type. The automatically generated filename is guaranteed not to conflict with any filename currently in the directory. You may replace or modify this filename using the File Name softkey. See the Quick Save key documentation for more on the automatic file naming algorithm.

The default path for all Sequence Files is:

My Documents\Sequences

Key Path	Save, Sequences
Mode	All

Notes	Brings up Save As dialog for saving a Sequence Save Type
Initial S/W Revision	A.05.00

Data (Export)

Exporting a data file stores data from the current measurement to mass storage files. The Export Menu only contains data types that are supported by the current measurement.

Since the commonly exported data files are in .csv format, the data can be edited by you prior to importing. This allows you to export a data file, manipulate the data in Excel (the most common PC Application for manipulating .csv files) and then import it.

Selecting an Export Data menu key will not actually cause the exporting to occur, since the analyzer still needs to know where you wish to save the data. Pressing the Save As key in this menu brings up the Save As dialog and Save As menu that allows you to specify the destination file and directory. Once a filename has been selected or entered in the Open menu, the export will occur as soon as the Save key is pressed.

Key Path	Save
Mode	All
Notes	The menu is built from whatever data types are available for the mode. So the key locations in the sub menu will vary. No SCPI command directly controls the Data Type that this key controls. The Data Type is included in the MMEM:STOR commands.
Dependencies	If a file type is not used by a certain measurement, that type is grayed out for that measurement. The key for a file type will not show at all if there are no measurements in the Mode that support it.
Preset	Is not affected by a Preset or shutdown, but is reset during Restore Mode Defaults
Readback	The data type that is currently selected
Initial S/W Revision	Prior to A.02.00

Measurement Results

Pressing this key selects Meas Results as the data type to be exported.

The Meas Results file contains information which describes the current state of the analyzer. It is detailed in Meas Result File Contents below.

Key Path	Save, Data
Remote Command	:MMEMory:STOR:RESults <string>
Example	:MMEM:STOR:RES "MeasR_0000.csv"
Notes	If the save is initiated via SCPI and the file already exists, the file will be overwritten. The SCPI command exports Channel Power measurement results to the file specified as the parameter in the current path. The default path is My Documents\<current mode>\data\CHP\results.

	Using the C: drive is strongly discouraged, since it runs the risk of being overwritten during an instrument software upgrade. The SCPI parameter is a quoted string, which specifies the filename. Both single and double quotes are supported for any filename parameter over SCPI.
Dependencies	The current active measurement must be the Channel Power measurement to use this command.
Status Bits/OPC dependencies	Sequential - waits for the previous measurement to complete.
Initial S/W Revision	Prior to A.02.00

Meas Results File Contents

A Meas Results File contains measurement results with the following information.

- File ID string, which is “MeasResult”
- Measurement ID following Mode ID, which is “SA:CHP” for example.
- Firmware rev and model number
- Option string
- Auto Sweep Time Rules
- Average Mode
- Average Number
- Average State
- Center Frequency
- Detector
- Electrical Atten
- Electrical Atten State
- IFGain
- IFGainAuto
- Impedance
- Integ BW
- Internal Preamp
- Internal Preamp Band
- Mechanical Atten
- MechanicalAttenStepEnum
- PSD Unit
- Resolution Band Width

- Resolution Bandwidth Shape
- RRC Filter Alpha
- RRC Filter BW
- RRC Filter State
- Span
- Sweep Points
- Sweep Time
- Sweep Time Auto
- TriggerSource
- Video Bandwidth
- Y Axis Unit

The file contains these data followed by MeasResult1 and MeasResult2 that flag the start of the measurement results. Each line of Measurement Results consists of two comma separated values, MeasResult1 value and MeasResult2 value. MeasResult1 contains the same results as MEAS/READ/FETCH:CHPower1; MeasResult2, MEAS/READ/FETCH:CHPower2.

Exported file is .csv file. The Meas Results file, when imported into Excel, will show the following data:

MeasResult	
SA:CHP	
A.10.53	N9030A
526 ALV ATP B1X B1Y B25 B40 BBA CR3 CRP DCF DDA DP2 DRD EA3 EDP EMC EP1 ERC ESC ESP EXM FSA LFE LNP MAT MPB NFE NUL P26 PFR PNC RTL RTS S40 SB1 SEC SM1 TVT YAS YAV	1
Auto Sweep Time Rules	Normal
Average Mode	Exponential
Average Number	10
Average State	TRUE
Center Frequency	13255000000
Detector	Average
IFGain	FALSE
IFGainAuto	FALSE
Impedance	50
Integ BW	2000000
Internal Preamp	FALSE
Internal Preamp Band	Low
PSD Unit	DbmHz

Resolution Band Width	27000
Resolution Bandwidth Shape	Gaussian
RRC Filter Alpha	0.22
RRC Filter BW	3840000
RRC Filter State	FALSE
Span	3000000
Sweep Points	1001
Sweep Time	0.004933333
Sweep Time Auto	TRUE
TriggerSource	Free
Video Bandwidth	270000
Y Axis Unit	DecibelMilliwatt
MeasResult1	MeasResult2
-76.8141133132837	-95.29174
-139.824413269924	-94.99601
	-94.95281
	-95.17146

Capture Buffer

This function allows you to store captured data for reuse in demod measurements using 'Save/Recall' functionality for 'Capture Buffer'. (This function is enabled for 'Code Domain' and 'Modulation Accuracy' measurements ONLY)

'Capture Buffer' is saved and loaded as IQ Data with properties which show Sample Rate, Length, IF BW, etc.

Use-Case are as followings;

Use Capture Buffer to perform analysis of the same captured data using 'Code Domain' and 'Modulation Accuracy' measurements, or to playback previously saved captured data.

Key Path	Save, Data
Mode	CDMA2000
Example	MMEM:STOR:CAPT "MyCaptureData.bin" This stores the capture data in the file MyCaptureData.bin in the default directory.
Dependencies	Capture buffer functionality is only available for Code Domain and Modulation Accuracy measurement. In other measurements, this key is grayed out.
Initial S/W Revision	Prior to A.02.00

Save As . . .

When you press “Save As”, the analyzer brings up a Windows dialog and a menu entitled “**Save As.**” This menu allows you to navigate to the various fields in the Windows dialog without using a keyboard or mouse. The Tab and Arrow keys can also be used for dialog navigation.

See "[To File . . .](#)" on page 2070 in Save, State for a full description of this dialog and menu.

The default path for saving files is:

For all of the Trace Data Files:

My Documents\<<mode name>\data\traces

For all of the Limit Data Files:

My Documents\<<mode name>\data\limits

For all of the Measurement Results Data Files:

My Documents\<<mode name>\data\<<measurement name>\results

For all of the Capture Buffer Data Files:

My Documents\<<mode name>\data\captureBuffer

Key Path	Save, Data
Mode	All
Notes	The key location is mode-dependent and will vary. Brings up the Save As dialog for saving a <mode specific> Save Type. The save is performed immediately and does not wait until the measurement is complete.
Initial S/W Revision	Prior to A.02.00

Screen Image

Pressing Screen Image accesses a menu of functions that enable you to specify a format and location for the saved screen image. It brings up a menu that allows you to specify the color scheme of the Screen Image (Themes) or navigate to the Save As dialog to perform the actual save.

Screen Image files contain an exact representation of the analyzer display. They cannot be loaded back onto the analyzer, but they can be loaded into your PC for use in many popular applications.

The image to be saved is actually captured when the Save front panel key is pressed, and kept in temporary storage to be used if you ask for a Screen Image save. When the Screen Image key is pressed, a "thumbnail" of the captured image is displayed, as shown below:

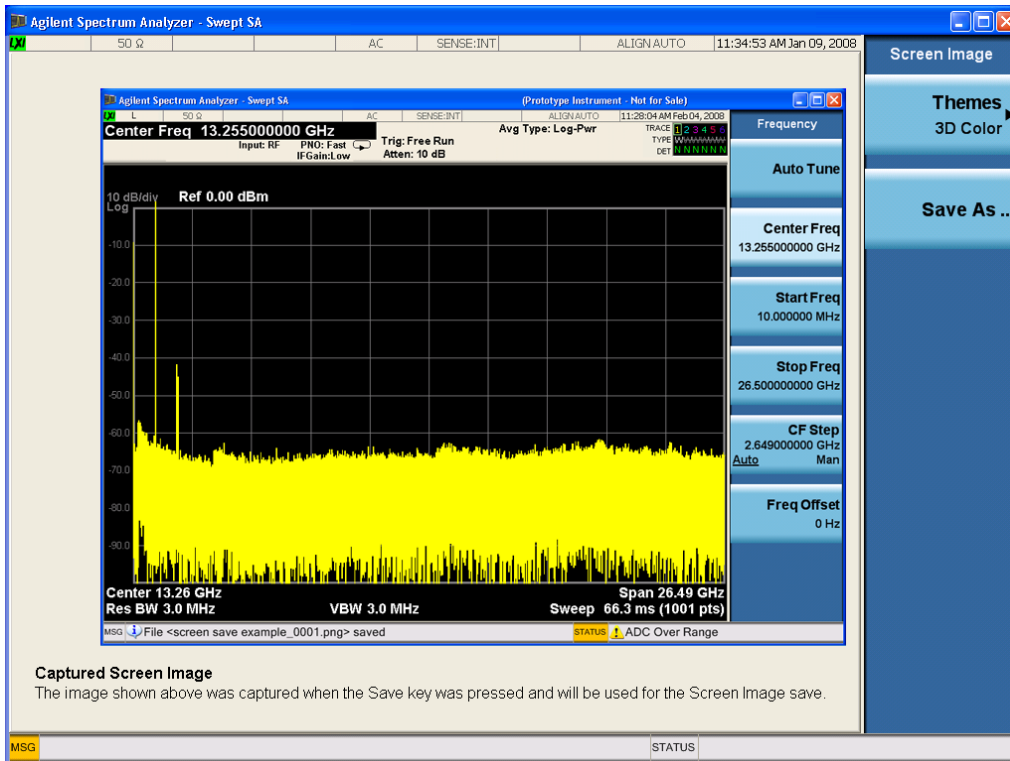

When you continue on into the Save As menu and complete the Screen Image save, the image depicted in the thumbnail is the one that gets saved, showing the menus that were on the screen before going into the Save menu. The save is performed immediately and does not wait until the measurement is complete.

After you have completed the save, the Quick Save front-panel key lets you quickly repeat the last save performed, using an auto-named file, with the current screen data.

NOTE For versions previous to A.01.55, if you initiate a screen image save by navigating through the Save menus, the image that is saved will contain the Save menu softkeys, not the menus and the active function that were on the screen when you first pressed the Save front panel key.

Key Path	Save
Mode	All
Remote Command	:MMEMory:STORe:SCREen <filename>
Example	:MMEM:STOR:SCR "myScreen.png" This stores the current screen image in the file MyScreenFile.png in the default directory.
Initial S/W Revision	Prior to A.02.00

Themes

Accesses a menu of functions that enable you to choose the theme to be used when saving the screen image.

The **Themes** option is the same as the **Themes** option under the **Display** and **Page Setup** dialogs. It allows you to choose between themes to be used when saving the screen image.

Key Path	Save, Screen Image
Remote Command	:MMEMory:STORe:SCReem:THEMe TDColor TDMonochrome FCOLor FMONochrome :MMEMory:STORe:SCReem:THEMe?
Example	:MMEM:STOR:SCR:THEM TDM
Preset	3D Color; Is not part of Preset, but is reset by Restore Misc Defaults or Restore System Defaults All and survives subsequent running of the modes.
Readback	3D Color 3D Mono Flat Color Flat Mono
Backwards Compatibility Notes	In ESA and PSA we offer the choice of "Reverse Bitmap" or "Reverse Metafile" when saving screen images. This is much like the "Flat Color" theme available in X-Series. Also, if you selected Reverse Bitmap AND a black & white screen image, that would be much like "Flat Monochrome". In other words, each of the X-Series themes has a similar screen image type in ESA/PSA. But they are not identical.
Initial S/W Revision	Prior to A.02.00

3D Color

Selects a standard color theme with each object filled, shaded and colored as designed.

Key Path	Save, Screen Image, Themes
Example	MMEM:STOR:SCR:THEM TDC
Readback	3D Color
Initial S/W Revision	Prior to A.02.00

3D Monochrome

Selects a format that is like 3D color but shades of gray are used instead of colors.

Key Path	Save, Screen Image, Themes
Example	MMEM:STOR:SCR:THEM TDM
Readback	3D Mono
Initial S/W Revision	Prior to A.02.00

Flat Color

Selects a format that is best when the screen is to be printed on an ink printer.

Key Path	Save, Screen Image, Themes
-----------------	----------------------------

Example	MMEM:STOR:SCR:THEM FCOL
Readback	Flat Color
Initial S/W Revision	Prior to A.02.00

Flat Monochrome

Selects a format that is like Flat Color. But only black is used (no colors, not even gray), and no fill.

Key Path	Save, Screen Image, Themes
Example	MMEM:STOR:SCR:THEM FMON
Readback	Flat Mono
Initial S/W Revision	Prior to A.02.00

Save As...

When you press "Save As", the analyzer brings up a Windows dialog and a menu entitled "**Save As.**" This menu allows you to navigate to the various fields in the Windows dialog without using a keyboard or mouse. The Tab and Arrow keys can also be used for dialog navigation.

See "[To File . . .](#)" on page 2070 in Save, State for a full description of this dialog and menu.

The default path for Screen Images is

My Documents\`<mode name>`\screen.

where `<mode name>` is the parameter used to select the mode with the INST:SEL command (for example, SA for the Spectrum Analyzer).

Key Path	Save, Screen Image
Notes	Brings up Save As dialog for saving a Screen Image Save Type
Initial S/W Revision	Prior to A.02.00

Single (Single Measurement/Sweep)

Sets the analyzer for Single measurement operation. The single/continuous state is Meas Global, so the setting will affect all the measurements. If you are Paused, pressing Single does a Resume.

See "[More Information](#)" on page 390

Key Path	Front-panel key
Example	:INIT:CONT OFF
Notes	See Cont key description.
Backwards Compatibility Notes	<p>For Spectrum Analysis mode in ESA and PSA, the Single hardkey and the INITiate:IMM switched from continuous measurement to single measurement and restarted sweeps and averages (displayed average count reset to 1), but did not restart Max Hold and Min Hold. In the X-Series, the Single hardkey and the INITiate:IMM command initiate a sweep/ measurement/ average sequence/hold sequence including MaxHold and MinHold.</p> <p>For Spectrum Analysis mode in ESA and PSA, the Single hardkey restarted the sweep regardless of whether or not you were in an active sweep or sweep sequence. In the X-Series, Restart does this but Single only restarts the sweep or sweep sequence if you are in the idle state.</p> <p>INIT[:IMM] in ESA & PSA Spectrum Analysis Mode does an implied ABORT. In some other PSA Modes, INIT[:IMM] is ignored if not in the idle state. . The X-Series follows the ESA/PSA SA Mode model, which may cause some Modes to have compatibility problems.</p>
Initial S/W Revision	Prior to A.02.00

More Information

See "[Restart](#)" on page 2067 for details on the INIT:IMMEDIATE (Restart) function.

If you are already in single sweep, the INIT:CONT OFF command has no effect.

If you are already in Single Sweep, then pressing the Single key in the middle of a sweep does not restart the sweep or sequence. Similarly, pressing the Single key does not restart the sweep or sequence if the sweep is not in the idle state (for example, if you are taking a very slow sweep, or the analyzer is waiting for a trigger). Instead, it results in a message. "Already in Single, press Restart to initiate a new sweep or sequence". Even though pressing the Single key in the middle of a sweep does not restart the sweep, sending INIT:IMMEDIATE does reset it.

To take one more sweep without resetting the average count, increment the average count by 1, by pressing the step up key while **Average/Hold Number** is the active function, or sending the remote command CALC:AVER:TCON UP.

Source

Opens a menu of keys that access various source configuration menus and settings. In the test set, pressing this key also causes the central view area to change and display the Source Control Main view.

Key Path	Front-panel key
----------	-----------------

RF Output

This parameter sets the source RF power output state.

Key Path	Source
Remote Command	:OUTPut[:EXTernal][:STATe] ON OFF 1 0 :OUTPut[:EXTernal][:STATe]?
Example	OUTP OFF OUTP?
Notes	<p>The EXTERNAL node is shown in RD text so the SCPI remains the same between internal and external source control. However, for EXT we do not wish to document this node to the customer since we are controlling the internal source rather than the external source.</p> <p>This setting is for the independent mode and has no effect on the "List Sequencer" on page 2168. If the "Sequencer" on page 2168 is set to ON, the list sequencer controls the source output and this key will be grayed-out. And this setting will be none-forceful grey out on front panel to indicate out-of-scope. Non-forceful means user still can change this setting by SCPI but cannot change on front panel. When set to OFF will make source leave list sequencer and this setting will be black out and take effect immediately.</p> <p>When the RF Output is ON, an "RF" annunciator is displayed in the system settings panel. When the RF Output is turned Off, the RF annunciator is cleared. If the "Sequencer" on page 2168 is set to ON, the "RF" annunciator will be replaced by "SEQ" in the system settings panel, indicating that the output is controlled by the list sequencer.</p>
Preset	Off
Range	On Off
Initial S/W Revision	A.05.00

Amplitude

Allows you to access the Amplitude sub-menu.

Key Path	Source
Notes	<p>The sub-menu under this button is for independent mode and has no effect on "List Sequencer" on page 2168. If the "Sequencer" on page 2168 is set to ON, the list sequencer controls the source output and this key will be grayed-out on front panel to indicate out-of-scope. When you set "Sequencer" on page 2168 to Off will make source leave list sequencer and this button will be black out.</p>
Initial S/W Revision	A.05.00

RF Power

Allows you to adjust the power level of the source using the numeric keypad, step keys, or RPG. Pressing any digit, 0 through 9, on the numeric keypad brings up the unit terminator.

Please refer to the ["RF Power Range " on page 393](#) table below for the valid ranges.

Key Path	Source, Amplitude
Remote Command	:SOURce:POWer[:LEVel][:IMMediate][:AMPLitude] <ampl> :SOURce:POWer[:LEVel][:IMMediate][:AMPLitude]?
Example	:SOUR:POW -100 dBm
Notes	<p>Amplitude corrections can be specified for use with the source. In the event of amplitude corrections being applied, the valid ranges for the RF power do not change dependant on the current amplitude correction setting. If the combination of RF power + amplitude correction is higher or lower than the source output range, the Source Unleveled bit is set and the "Source Unleveled" indicator will appear on status panel to indicate that the source cannot maintain the output power that has been requested.</p> <p>When signal generator is unable to maintain the requested output level, the "Source Unleveled" indicator will appear on status panel. When the source output setting is restored to the normal range, the "Source Unleveled" is removed from status panel.</p> <p>Internal source has list sequence mode, which comprises of several steps which contain separate output power, frequency and waveform etc. When the source list sequence playing is complete, the last step keeps playing, and user can use this command to change the list sequence last step's output power.</p> <p>The multiport adapter RFIO TX ports and GPS ports cannot ensure power accuracy when power setting is lower than -130dBm, this power setting value is defined by the sum of RF Power setting and related amplitude correction value. But user settable value could be lower than this limit. When application detected there exists power setting lower than -130dBm on MPA RFIO TX ports, then popup warning message . When application detected there exists power setting lower than -130dBm on MPA GPS ports, then popup warning message . This is only warning message, and check is performed when RF is ON.</p>
Notes	The Min and Max value here defined UI settable amplitude range. This range is larger than actual amplitude range with level accuracy defined in spec.
Dependencies	The RF power is dependent on the RF output port and frequency, such that the current frequency and selected output port determine the valid range of power values.
Preset	-100 dBm
Min	The range of values depends on the current frequency and selected RF output port. Please refer to the "RF Power Range " on page 393 table below for the valid ranges.
Max	The range of values depends on the current frequency and selected RF output port. Please refer to the "RF Power Range " on page 393 table below for the valid ranges.
Initial S/W Revision	A.05.00

All other models:

RF Power Range

RF Output Port	Frequency Range	Min Output Power	Max Output Power
High Power RF Out	10 MHz \leq f \leq 6 GHz	-150 dBm	20 dBm
RFIO 1 & RFIO 2	10 MHz \leq f \leq 6 GHz	-150 dBm	0 dBm
GPS (Note2)	10 MHz \leq f \leq 6 GHz	-150 dBm	0 dBm

Note: This is the UI power range, it's larger than actual spec.

Note2: GPS port is on the multiport adapter, or E6607C which has embedded MPA.

M9420A:

RF Power Range

RF Output Port	Frequency Range	Min Output Power	Max Output Power without Option "1EA"	Max Output Power with Option "1EA"
RF Output	60 MHz \leq f \leq 6 GHz	-150 dBm	10 dBm	18 dBm
RFHD	60 MHz \leq f \leq 6 GHz	-150 dBm	10 dBm	15 dBm
RFFD	60 MHz \leq f \leq 6 GHz	-150 dBm	0 dBm	0 dBm

Set Reference Power

This key allows you to set the power reference. Pressing this key turns the power reference state to ON, sets the reference power value to the current RF output power, maintains this power at the RF output, and sets the displayed power to 0.00 dB. All subsequent RF power values entered under Source>Amplitude>RF Power are interpreted as being relative to this reference power.

When you use a power reference, the signal generator outputs an RF power that is set relative to the reference power by the value entered under Source>Amplitude>RF Power as follows:

Output power = reference power – entered power

Where:

reference power equals the original RF Power entered under Source>Amplitude>RF Power and set as the reference power

entered power equals a new value entered under Source>Amplitude>Amptd Offset

In addition, the displayed power value is the same as a new value entered under Source>Amplitude>RF Power.

NOTE

If Power Ref is set to ON with a reference value set, entering a value under Source>Amplitude>RF Power and pressing Set Reference Power will add that value to the existing Power Ref value.

If you wish to change the reference power value to a new value entered under Source>Amplitude>RF Power, first you must set Power Ref to OFF and then press Set Reference Power.

Key Path	Source, Amplitude
Dependencies	This key is unavailable, and is grayed out when the "List Sequencer" on page 2168 is turned ON.
Initial S/W Revision	A.05.00

Power Ref

This key allows you to toggle the state of the power reference.

When you use a power reference, the signal generator outputs an RF power that is set relative to the reference power by the value entered under Source>Amplitude>RF Power as follows:

Output power = reference power + entered power

Where:

reference power equals the original RF Power entered under Source>Amplitude>RF Power and set as the reference power

entered power equals a new value entered under Source>Amplitude>Amptd Offset

For more information on Reference Frequency refer to ["Set Reference Power " on page 2099](#)

Key Path	Source, Amplitude
Remote Command	:SOURce:POWer:REFerence <ampl> :SOURce:POWer:REFerence? :SOURce:POWer:REFerence:STATe OFF ON 0 1 :SOURce:POWer:REFerence:STATe?
Example	:SOUR:POW:REF 0.00 dBm :SOUR:POW:REF:STATe ON
Dependencies	This setting is unavailable and is grayed out when the "List Sequencer" on page 2168 is turned ON.
Couplings	This value is coupled to the "Set Reference Power " on page 2099 key such that pressing the Set Reference Power key updates the reference power with the current output power.
Preset	0.00 dBm OFF
Min	-125.00 dBm
Max	10.00 dBm
Initial S/W Revision	A.05.00

Amptd Offset

Allows you to specify the RF output power offset value.

When the amplitude offset is set to zero (0) and you set a new offset value (positive or negative), the displayed amplitude value will change as follows and the RF output power will not change:

Displayed value = output power + offset value

Where:

output power equals the original RF Power entered under Source>Amplitude>RF Power

offset value equals the value entered under Source>Amplitude>Amptd Offset

When the amplitude offset is set to a value other than zero (0) and you enter a new RF power value under Source>Amplitude>RF Power, the displayed power will be the same as the value entered and the RF output power will be equal to the value entered minus the offset value as follows:

Output power = entered power – offset power

Displayed Power = output power + offset power

Displayed power = entered power

Where:

entered power equals the amplitude entered under Source>Amplitude>RF Power

offset power equals the value previously entered and set under Source>Amplitude>Amptd Offset

Key Path	Source, Amplitude
Remote Command	:SOURce:POWer[:LEVel][:IMMediate]:OFFSet <rel_ampl> :SOURce:POWer[:LEVel][:IMMediate]:OFFSet?
Example	:SOUR:POW:OFFS 0.00 dB
Dependencies	This setting is unavailable, and is grayed out when the List Sequencer is turned ON.
Preset	0.00 dB
Min	-200.00 dB
Max	200.00 dB
Initial S/W Revision	A.05.00

Modulation

Allows you to toggle the state of the modulation.

Key Path	Source
Remote Command	:OUTPut:MODulation[:STATe] ON OFF 1 0 :OUTPut:MODulation[:STATe]?
Example	:OUTP:MOD OFF
Notes	This setting is for independent mode and has no effect on " List Sequencer " on page 2168. If the " Sequencer " on page 2168 is set to ON, the list sequencer controls the source output and this key will be grayed-out. And this setting will be none-forceful grey out on front panel to indicate out-of-scope. Non-forceful means user still can change this setting by SCPI but cannot change manually on front panel. When set to Off will make source leave list sequencer and this setting will be black out and take effect immediately. When the Modulation is ON, the "MOD" annunciator is displayed in the system settings panel. When the Modulation is turned Off, the "MOD" annunciator is cleared. If the

	"Sequencer" on page 2168 is set to ON, the "MOD" annunciator will be replaced by "SEQ" in the system settings panel indicating that the output is controlled by list sequencer.
Preset	Off
Range	On Off
Initial S/W Revision	A.05.00

Frequency

Allows you to access the Frequency sub-menu.

Key Path	Source
Notes	The sub-menu under this button is for independent mode and has no effect on "List Sequencer" on page 2168. If the "Sequencer" on page 2168 is set to ON, the list sequencer controls the source output and this key will be grayed-out. And this button will be grey out on front panel to indicate out-of-scope. When set to Off will make source leave list sequencer and this button will be black out.
Initial S/W Revision	A.05.00

Frequency

Allows you to set the RF Output Frequency. You can adjust the frequency of the source using the numeric keypad, step keys, or RPG. Pressing any digit, 0 through 9, on the numeric keypad brings up the unit terminator.

Key Path	Source, Frequency
Remote Command	:SOURce:FREQuency[:CW] <freq> :SOURce:FREQuency[:CW]?
Example	:SOUR:FREQ 1.00 GHz
Notes	Internal source has list sequence mode, which comprises of several steps which contain separate output power, frequency and waveform etc. When the source list sequence playing is complete, the last step keeps playing, and user can use this command to change the list sequence last step's output frequency.
Couplings	The frequency value is coupled to the current channel band and number, such that updates to the band and number will update the frequency value to the corresponding absolute frequency.
Preset	1.00 GHz If license F1A or 5WC is present, the default Center Frequency should be 2.412GHz.
Min	10.00 MHz
Max	Hardware Dependant: Option 503 = 3.6 GHz Option 504 = 3.8 GHz Option 506 = 6.00 GHz For E6640A, if license 5WC is present, the frequency range should be limited to: 1.1GHz-1.7GHz,

2.4GHz–2.5GHz, 4.8GHz–6.0GHz. If the user-defined frequency is outside of range, UI will report an error message called "Settings conflict; Frequency is outside available range".

Initial S/W Revision A.05.00

Channel

The frequency of the source can be specified by a channel number of a given frequency band. This key allows you to specify the current channel number. For the appropriate range of channel numbers for a given frequency band, refer to the following tables: ["GSM/EDGE Channel Number Ranges" on page 397](#), ["W-CDMA Channel Number Ranges" on page 398](#), ["CDMA 2000 / 1xEVDO Channel Number Ranges" on page 400](#), and ["LTE FDD Channel Number Ranges" on page 402](#).

Key Path	Source, Frequency
Remote Command	:SOURce:FREQuency:CHANnels:NUMBer <int> :SOURce:FREQuency:CHANnels:NUMBer?
Example	:SOUR:FREQ:CHAN:NUMB 1
Notes	This key is grayed out when the "Radio Standard" on page 2111 is set to NONE. This key is grayed out on E6630A.
Dependencies	This key is grayed out when the "Radio Standard" on page 2111 is set to NONE. This key is grayed out on E6630A.
Couplings	The channel number is coupled to the frequency value when the "Radio Standard" on page 2111 is not set to NONE. When the frequency value is changed, the channel number will increase or decrease to match the new frequency. If the frequency is not at an exact match for a channel number, the nearest channel number is displayed along with a greater than or less than sign to indicate the frequency is above or below the channel number.
Preset	1
Min	Please refer to the tables below for the valid ranges.
Max	Please refer to the tables below for the valid ranges.
Initial S/W Revision	A.05.00

GSM/EDGE Channel Number Ranges

Band	Link (Device)	Range	Frequency (MHz)
P-GSM	Uplink (MS)	$1 \leq n \leq 124$	$890.0 + 0.2*n$
	Downlink (BS)	$1 \leq n \leq 124$	$935.0 + 0.2*n$
E-GSM	Uplink (MS)	$0 \leq n \leq 124$	$890.0 + 0.2*n$
		$975 \leq n \leq 1023$	$890.0 + 0.2*(n-1024)$
	Downlink (BS)	$0 \leq n \leq 124$	$935.0 + 0.2*n$
		$975 \leq n \leq 1023$	$935.0 + 0.2*(n-1024)$

Band	Link (Device)	Range	Frequency (MHz)
DCS 1800	Uplink (MS)	$512 \leq n \leq 885$	$1710.200 + 0.20*(n-512)$
	Downlink (BS)	$512 \leq n \leq 885$	$1805.200 + 0.20*(n-512)$
PCS 1900	Uplink (MS)	$512 \leq n \leq 810$	$1850.200 + 0.2*(n-512)$
	Downlink (BS)	$512 \leq n \leq 810$	$1930.200 + 0.2*(n-512)$
R-GSM	Uplink (MS)	$0 \leq n \leq 124$	$890.0 + 0.2*n$
		$955 \leq n \leq 1023$	$890.0 + 0.2*(n-1024)$
	Downlink (BS)	$0 \leq n \leq 124$	$935.0 + 0.2*n$
		$955 \leq n \leq 1023$	$935.0 + 0.2*(n-1024)$
GSM 450	Uplink (MS)	$256 \leq n \leq 293$	$450.6 + 0.2*(n-259)$
	Downlink (BS)	$256 \leq n \leq 293$	$460.6 + 0.2*(n-259)$
GSM 480	Uplink (MS)	$306 \leq n \leq 340$	$479.000 + 0.20*(n-306)$
	Downlink (BS)	$306 \leq n \leq 340$	$489.000 + 0.20*(n-306)$
GSM 850	Uplink (MS)	$128 \leq n \leq 251$	$824.200 + 0.20*(n-128)$
	Downlink (BS)	$128 \leq n \leq 251$	$869.200 + 0.20*(n-128)$
GSM 700	Uplink (MS)	$438 \leq n \leq 516$	$777.200 + 0.20*(n-438)$
	Downlink (BS)	$438 \leq n \leq 516$	$747.200 + 0.20*(n-438)$
T-GSM810	Uplink (MS)	$350 \leq n \leq 425$	$806.0 + 0.20*(n-350)$
	Downlink (BS)	$350 \leq n \leq 425$	$851.0 + 0.20*(n-350)$

W-CDMA Channel Number Ranges

Band	Link (Device)	Range	Frequency (MHz)
Band I	Downlink	$10562 \leq n \leq 10838$	$n \div 5$
	Uplink	$9612 \leq n \leq 9888$	$n \div 5$
Band II	Downlink	$412 \leq n \leq 687$	$n \div 5 + 1850.1$
		$9662 \leq n \leq 9938$	$n \div 5$
	Uplink	$12 \leq n \leq 287$	$n \div 5 + 1850.1$
		$350 \leq n \leq 425$	$n \div 5$
Band III	Downlink	$1162 \leq n \leq 1513$	$n \div 5 + 1575$
	Uplink	$937 \leq n \leq 1288$	$n \div 5 + 1525$
Band IV	Downlink	$537 \leq n \leq 1738$	$n \div 5 + 1805$
		$1887 \leq n \leq 2087$	$n \div 5 + 1735.1$
	Uplink	$1312 \leq n \leq 1513$	$n \div 5 + 1450$
		$1662 \leq n \leq 1862$	$n \div 5 + 1380.1$
Band V	Downlink	$1007 \leq n \leq 1087$	$n \div 5 + 670.1$
		$4357 \leq n \leq 4458$	$n \div 5$

Band	Link (Device)	Range	Frequency (MHz)
	Uplink	$782 \leq n \leq 862$	$n \div 5 + 670.1$
		$4132 \leq n \leq 4233$	$n \div 5$
Band VI	Downlink	$1037 \leq n \leq 1062$	$n \div 5 + 670.1$
		$4387 \leq n \leq 4413$	$n \div 5$
	Uplink	$812 \leq n \leq 837$	$n \div 5 + 670.1$
		$4162 \leq n \leq 4188$	$n \div 5$
Band VII	Downlink	$2237 \leq n \leq 2563$	$n \div 5 + 2175$
		$2587 \leq n \leq 2912$	$n \div 5 + 2105.1$
	Uplink	$2012 \leq n \leq 2338$	$n \div 5 + 2100$
		$2362 \leq n \leq 2687$	$n \div 5 + 2030.1$
Band VIII	Downlink	$2937 \leq n \leq 3088$	$n \div 5 + 340$
	Uplink	$2712 \leq n \leq 2863$	$n \div 5 + 340$
Band IX	Downlink	$9237 \leq n \leq 9387$	$n \div 5$
	Uplink	$8762 \leq n \leq 8912$	$n \div 5$
Band X	Downlink	$3112 \leq n \leq 3388$	$n \div 5 + 1490$
		$3412 \leq n \leq 3687$	$n \div 5 + 1430.1$
	Uplink	$2887 \leq n \leq 3163$	$n \div 5 + 1135$
		$3187 \leq n \leq 3462$	$n \div 5 + 1075.1$
Band XI	Downlink	$3712 \leq n \leq 3812$	$n \div 5 + 736$
	Uplink	$3487 \leq n \leq 3587$	$n \div 5 + 733$
Band XII	Downlink	$3837 \leq n \leq 3903$	$n \div 5 - 37$
		$3927 \leq n \leq 3992$	$n \div 5 - 54.9$
	Uplink	$3612 \leq n \leq 3678$	$n \div 5 - 22$
		$3702 \leq n \leq 3767$	$n \div 5 - 39.9$
Band XIII	Downlink	$4017 \leq n \leq 4043$	$n \div 5 - 55$
		$4067 \leq n \leq 4092$	$n \div 5 - 64.9$
	Uplink	$3792 \leq n \leq 3818$	$n \div 5 + 21$
		$3702 \leq n \leq 3767$	$n \div 5 - 39.9$
Band XIV	Downlink	$4117 \leq n \leq 4143$	$n \div 5 - 63$
		$4167 \leq n \leq 4192$	$n \div 5 - 72.9$
	Uplink	$3892 \leq n \leq 3918$	$n \div 5 + 12$
		$3942 \leq n \leq 3967$	$n \div 5 + 2.1$
Band XIX	Downlink	$712 \leq n \leq 763$	$n \div 5 + 735$
		$787 \leq n \leq 837$	$n \div 5 + 720.1$
	Uplink	$312 \leq n \leq 363$	$n \div 5 + 770$
		$387 \leq n \leq 437$	$n \div 5 + 755.1$

CDMA 2000 / 1xEVDO Channel Number Ranges

Band	Link (Device)	Range	Frequency (MHz)
US Cellular	Uplink (MS, reverse link)	$1 \leq N \leq 799$	$0.030 \times N + 825.000$
		$991 \leq N \leq 1023$	$0.030 \times (N - 1023) + 825.000$
		$1024 \leq N \leq 1323$	$0.030 \times (N - 1024) + 815.040$
	Downlink (BS, forward link)	$1 \leq N \leq 799$	$0.030 \times N + 870.000$
		$991 \leq N \leq 1023$	$0.030 \times (N - 1023) + 870.000$
		$1024 \leq N \leq 1323$	$0.030 \times (N - 1024) + 860.040$
US PCS	Uplink (MS, reverse link)	$0 \leq N \leq 1199$	$1850.000 + 0.050 \times N$
	Downlink (BS, forward link)	$0 \leq N \leq 1199$	$1930.000 + 0.050 \times N$
Japan Cellular Band	Uplink (MS, reverse link)	$1 \leq N \leq 799$	$0.0125 \times (N + 915.000)$
		$801 \leq N \leq 1039$	$0.0125 \times (N - 800) + 898.000$
		$1041 \leq N \leq 1199$	$0.0125 \times (N - 1040) + 887.000$
		$1201 \leq N \leq 1600$	$0.0125 \times (N - 1200) + 893.000$
	Downlink (BS, forward link)	$1 \leq N \leq 799$	$0.0125 \times (N + 860.000)$
		$801 \leq N \leq 1039$	$0.0125 \times (N - 800) + 843.000$
		$1041 \leq N \leq 1199$	$0.0125 \times (N - 1040) + 832.000$
		$1201 \leq N \leq 1600$	$0.0125 \times (N - 1200) + 838.000$
Korean PCS Band	Uplink (MS, reverse link)	$0 \leq N \leq 599$	$0.050 \times N + 1750.000$
	Downlink (BS, forward link)	$0 \leq N \leq 599$	$0.050 \times N + 1840.000$
NMT-450 Band	Uplink (MS, reverse link)	$1 \leq N \leq 400$	$0.025 \times (N - 1) + 450.000$
		$472 \leq N \leq 871$	$0.025 \times (N - 472) + 410.000$
		$1039 \leq N \leq 1473$	$0.020 \times (N - 1024) + 451.010$
		$1536 \leq N \leq 1715$	$0.025 \times (N - 1536) + 479.000$
		$1792 \leq N \leq 2016$	$0.020 \times (N - 1792) + 479.000$
	Downlink (BS, forward link)	$1 \leq N \leq 400$	$0.025 \times (N - 1) + 460.000$
		$472 \leq N \leq 871$	$0.025 \times (N - 472) + 420.000$
		$1039 \leq N \leq 1473$	$0.020 \times (N - 1024) + 461.010$
		$1536 \leq N \leq 1715$	$0.025 \times (N - 1536) + 489.000$
		$1792 \leq N \leq 2016$	$0.020 \times (N - 1792) + 489.000$
IMT-2000 Band	Uplink (MS, reverse link)	$0 \leq N \leq 1199$	$1920.000 + 0.050 \times N$
	Downlink (BS, forward link)	$0 \leq N \leq 1199$	$2100.000 + 0.050 \times N$
Upper 700 MHz Band	Uplink (MS, reverse link)	$0 \leq N \leq 240$	$776.000 + 0.050 \times N$
	Downlink (BS, forward link)	$0 \leq N \leq 240$	$746.000 + 0.050 \times N$

Band	Link (Device)	Range	Frequency (MHz)
	forward link)		
Secondary 800 MHz Band	Uplink (MS, reverse link)	$0 \leq N \leq 719$ $720 \leq N \leq 919$	$0.025 \times N + 806.000$ $0.025 \times (N - 720) + 896.000$
	Downlink (BS, forward link)	$0 \leq N \leq 719$ $720 \leq N \leq 919$	$0.025 \times N + 851.000$ $0.025 \times (N - 720) + 935.000$
2.5 GHz IMT Extension	Uplink (MS, reverse link)	$0 \leq N \leq 1399$	$2500.000 + 0.050 \times N$
	Downlink (BS, forward link)	$0 \leq N \leq 1399$	$2620.000 + 0.050 \times N$
US PCS 1.9 GHz	Uplink (MS, reverse link)	$0 \leq N \leq 1299$	$1850.000 + 0.050 \times N$
	Downlink (BS, forward link)	$0 \leq N \leq 1299$	$1930.000 + 0.050 \times N$
AWS	Uplink (MS, reverse link)	$0 \leq N \leq 899$	$1710.000 + 0.050 \times N$
	Downlink (BS, forward link)	$0 \leq N \leq 899$	$2100.000 + 0.050 \times N$
US 2.5 GHz	Uplink (MS, reverse link)	$140 \leq N \leq 1459$	$2495.000 + 0.050 \times N$
	Downlink (BS, forward link)	$140 \leq N \leq 1459$	$2617.000 + 0.050 \times N$
700 Public Safety	Uplink (MS, reverse link)	$0 \leq N \leq 240$	$787.000 + 0.050 \times N$
	Downlink (BS, forward link)	$0 \leq N \leq 240$	$757.000 + 0.050 \times N$
C2K Lower 700	Uplink (MS, reverse link)	$0 \leq N \leq 360$	$698.000 + 0.050 \times N$
	Downlink (BS, forward link)	$0 \leq N \leq 360$	$728.000 + 0.050 \times N$
400 Euro PAMR	Uplink (MS, reverse link)	$1 \leq N \leq 400$	$0.025 \times (N - 1) + 450.000$
		$472 \leq N \leq 871$	$0.025 \times (N - 472) + 410.000$
	Uplink (MS, reverse link)	$1536 \leq N \leq 1715$	$0.025 \times (N - 1536) + 479.000$
	Uplink (MS, reverse link)		
	Downlink (BS, forward link)	$1 \leq N \leq 400$	$0.025 \times (N - 1) + 460.000$
		$472 \leq N \leq 871$	$0.025 \times (N - 472) + 420.000$
	Downlink (BS, forward link)	$1536 \leq N \leq 1715$	$0.025 \times (N - 1536) + 489.000$
	Downlink (BS, forward link)		

Band	Link (Device)	Range	Frequency (MHz)
800 PAMR	Uplink (MS, reverse link)	$0 \leq N \leq 239$	$870.0125 + 0.025 \times N$
	Downlink (BS, forward link)	$0 \leq N \leq 239$	$915.0125 + 0.025 \times N$

LTE FDD Channel Number Ranges

The carrier frequency in the uplink and downlink is designated by the E-UTRA Absolute Radio Frequency Channel Number (EARFCN) in the range 0 – 65535. The relation between EARFCN and the carrier frequency in MHz for the downlink is given by the following equation, where FDL_low and NOffs-DL are given in table 5.4.4–1 and NDL is the downlink EARFCN.

$$FDL = FDL_low + 0.1(NDL - NOffs-DL)$$

The relation between EARFCN and the carrier frequency in MHz for the uplink is given by the following equation where FUL_low and NOffs-UL are given in table 5.4.4–1 and NUL is the uplink EARFCN.

$$FUL = FUL_low + 0.1(NUL - NOffs-UL)$$

Band	Downlink		Uplink			
	FDL_low (MHz)	NOffs-DL	Range of NDL	FUL_low (MHz)	NOffs-UL	Range of NUL
1		2110	0	0 – 599	1920	18000 – 18599
2		1930	600	600 – 1199	1850	18600 – 19199
3		1805	1200	1200 – 1949	1710	19200 – 19949
4		2110	1950	1950 – 2399	1710	19950 – 20399
5		869	2400	2400 – 2649	824	20400 – 20649
6		875	2650	2650 – 2749	830	20650 – 20749
7		2620	2750	2750 – 3449	2500	20750 – 20449
8		925	3450	3450 – 3799	880	21450 – 21799
9		1844.9	3800	3800 – 4149	1749.9	21800 – 22149
10		2110	4150	4150 – 4749	1710	22150 – 22749
11		1475.9	4750	4750 – 4949	1427.9	22750 – 22949

Band	Downlink	Uplink				
12	729	5010	5010 - 5179	699	23010	23010 - 23179
13	746	5180	5180 - 5279	777	23180	23180 - 23279
14	758	5280	5280 - 5379	788	23280	23280 - 23379
...						
17	734	5730	5730 - 5849	704	23730	23730 - 23849
18	860	5850	5850 - 5999	815	23850	23850 - 23999
19	875	6000	6000 - 6149	830	24000	24000 - 24149
20	791	6150	6150 - 6449	832	24150	24150 - 24449
21	1495.9	6450	6450 - 6599	1447.9	24450	24450 - 24599
...						
24	1525	7700	7700 - 8039	1626.5	25700	25700 - 26039
25	1930	8040	8040 - 8689	1850	26040	26040 - 26689
26	859	8690	8690 - 9039	814	26690	26690 - 27039
...						

Note: The channel numbers that designate carrier frequencies so close to the operating band edges that the carrier extends beyond the operating band edge shall not be used. This implies that the first 7, 15, 25, 50, 75 and 100 channel numbers at the lower operating band edge and the last 6, 14, 24, 49, 74 and 99 channel numbers at the upper operating band edge shall not be used for channel bandwidths of 1.4, 3, 5, 10, 15 and 20 MHz respectively.

LTE TDD Channel Number Ranges

The carrier frequency in the uplink and downlink is designated by the E-UTRA Absolute Radio Frequency Channel Number (EARFCN) in the range 0 – 65535. The relation between EARFCN and the carrier frequency in MHz for the downlink is given by the following equation, where FDL_low and NOffs-DL are given in table 5.4.4-1 and NDL is the downlink EARFCN.

$$FDL = FDL_low + 0.1(NDL - NOffs-DL)$$

The relation between EARFCN and the carrier frequency in MHz for the uplink is given by the following equation where FUL_low and NOffs-UL are given in table 5.4.4-1 and NUL is the uplink EARFCN.

$$FUL = FUL_low + 0.1(NUL - NOffs-UL)$$

Band	Downlink		Uplink		
	NOffs-DL	Range of ND	FUL_low (MHz)	NOffs-UL	Range of NUL
33	1900	36000	36000 – 36199	1900	36000 – 36199
34	2010	36200	36200 – 36349	2010	36200 – 36349
35	1850	36350	36350 – 36949	1850	36350 – 36949
36	1930	36950	36950 – 37549	1930	36950 – 37549
37	1910	37550	37550 – 37749	1910	37550 – 37749
38	2570	37750	37750 – 38249	2570	37750 – 38249
39	1880	38250	38250 – 38649	1880	38250 – 38649
40	2300	38650	38650 – 39649	2300	38650 – 39649
41	2496	39650	39650 – 41589	2496	39650 – 41589
42	3400	41590	41590 – 43589	3400	41590 – 43589
43	3600	43590	43590 – 45589	3600	43590 – 45589

Note: The channel numbers that designate carrier frequencies so close to the operating band edges that the carrier extends beyond the operating band edge shall not be used. This implies that the first 7, 15, 25, 50, 75 and 100 channel numbers at the lower operating band edge and the last 6, 14, 24, 49, 74 and 99 channel numbers at the upper operating band edge shall not be used for channel bandwidths of 1.4, 3, 5, 10, 15 and 20 MHz respectively.

TDSCDMA Channel Number Ranges

1.28 Mcps TDD Option

No TX-RX frequency separation is required as Time Division Duplex (TDD) is employed. Each subframe consists of 7 main timeslots where all main timeslots (at least the first one) before the single switching point are allocated DL and all main timeslots (at least the last one) after the single switching point are allocated UL.

The nominal channel spacing is 1.6 MHz, but this can be adjusted to optimise performance in a particular deployment scenario.

The carrier frequency is designated by the UTRA absolute radio frequency channel number (UARFCN). The value of the UARFCN in the IMT2000 band is defined in the general case as follows:

$$N_t = 5 * F \quad 0.0 \text{ MHz} \leq F \leq 3276.6 \text{ MHz}$$

where F is the carrier frequency in MHz

Additional channels applicable to operation in the frequency band defined in sub-clause 5.2(d) are defined via the following UARFCN definition:

$$N_t = 5 * (F - 2150.1 \text{ MHz}) / 2572.5 \text{ MHz} \leq F \leq 2617.5 \text{ MHz}$$

UARFCN

1.28 Mcps TDD Option

The following UARFCN range shall be supported for each band:

**Table: UTRA Absolute Radio
Frequency Channel Number 1.28
Mcps TDD Option**

Frequency Band	Frequency Range	UARFCN Uplink and Downlink transmission
For operation in frequency band as defined in subclause 5.2 (a)	1900–1920 MHz	9504 to 9596
	2010–2025 MHz	10054 to 10121
For operation in frequency band as defined in subclause 5.2 (b)	1850–1910 MHz	9254 to 9546
	1930–1990 MHz	9654 to 9946
For operation in frequency band as defined in subclause 5.2 (c)	1910–1930 MHz	9554 to 9646
For operation in frequency band as defined in subclause 5.2 (d)	2570–2620 MHz	12854 to 13096
For operation in frequency band as defined in subclause 5.2 (e)	2300–2400 MHz	11504 to 11996
For operation in frequency band as defined in subclause 5.2 (f)	1880–1920 MHz	9404 to 9596

Radio Setup

Allows access to the sub-menus for selecting the radio standard and associated radio band. You can also set a frequency reference and offset.

This menu is greyed out when on E6630A. Radio band settings for GSM, cdma2000, and so on -- most of which are not actually supported in E6630A, which has three narrow frequency bands. So band settings are grayed out.

Key Path	Source, Frequency
Initial S/W Revision	A.05.00

Radio Standard

Allows access to the channel band sub-menus to select the desired radio standard. When you have selected the radio standard, you can then set an active channel band. The radio standard and the active

channel band allow you to use channel numbers to set frequency automatically.

Key Path	Source, Frequency, Radio Setup
Remote Command	:SOURce:FREQuency:CHANnels:BAND NONE PGSM EGSM RGSM DCS1800 PCS1900 TGSM810 GSM450 GSM480 GSM700 GSM850 BANDI BANDII BANDIII BANDIV BANDV BANDVI BANDVII BANDVIII BANDIX BANDX BANDXI BANDXII BANDXIII BANDXIV BANDXIX USCELL USPCS JAPAN KOREAN NMT IMT2K UPPER SECOND PAMR400 PAMR800 IMTEXT PCS1DOT9G AWS US2DOT5G PUBLIC LOWER BAND1 BAND2 BAND3 BAND4 BAND5 BAND6 BAND7 BAND8 BAND10 BAND11 BAND12 BAND13 BAND14 BAND17 BAND18 BAND19 BAND20 BAND21 BAND24 BAND25 BAND26 BAND27 BAND28 BAND29 BAND30 BAND31 BAND33 BAND34 BAND35 BAND36 BAND37 BAND38 BAND39 BAND40 BAND41 BAND42 BAND43 BAND44 BANDA BANDB BANDC BANDD BANDE BANDE :SOURce:FREQuency:CHANnels:BAND?
Example	:SOUR:FREQ:CHAN:BAND PGSM
Notes	Set this setting to "NONE" will grey out "Channel" on page 2103 Channel
Initial S/W Revision	A.05.00

None

Selects no radio standard for use. When you have selected the radio standard to NONE, you cannot use channel numbers to set frequency automatically. You will need to set the frequency manually.

Key Path	Source, Frequency, Radio Setup, Radio Standard
Initial S/W Revision	A.05.00

GSM/EDGE

Sets GSM/EDGE as the radio standard for use and accesses the GSM/EDGE specific channel band sub-menus.

Key Path	Source, Frequency, Radio Setup, Radio Standard
Initial S/W Revision	A.05.00

P-GSM

Selects P-GSM as the active channel band.

Key Path	Source, Frequency, Radio Setup, Radio Standard, GSM/EDGE
Example	:SOUR:FREQ:CHAN:BAND PGSM
Initial S/W Revision	A.05.00

E-GSM

Selects E-GSM as the active channel band.

Key Path	Source, Frequency, Radio Setup, Radio Standard, GSM/EDGE
Example	:SOUR:FREQ:CHAN:BAND EGSM
Initial S/W Revision	A.05.00

R-GSM

Selects R-GSM as the active channel band.

Key Path	Source, Frequency, Radio Setup, Radio Standard, GSM/EDGE
Example	:SOUR:FREQ:CHAN:BAND RGSM
Initial S/W Revision	A.05.00

DCS 1800

Selects DCS 1800 as the active channel band.

Key Path	Source, Frequency, Radio Setup, Radio Standard, GSM/EDGE
Example	:SOUR:FREQ:CHAN:BAND DCS1800
Initial S/W Revision	A.05.00

PCS 1900

Selects PCS 1900 as the active channel band.

Key Path	Source, Frequency, Radio Setup, Radio Standard, GSM/EDGE
Example	:SOUR:FREQ:CHAN:BAND PCS1900
Initial S/W Revision	A.05.00

GSM 450

Selects GSM 450 as the active channel band.

Key Path	Source, Frequency, Radio Setup, Radio Standard, GSM/EDGE
Example	:SOUR:FREQ:CHAN:BAND GSM450
Initial S/W Revision	A.05.00

GSM 480

Selects GSM 480 as the active channel band.

Key Path	Source, Frequency, Radio Setup, Radio Standard, GSM/EDGE
Example	:SOUR:FREQ:CHAN:BAND GSM480
Initial S/W Revision	A.05.00

GSM 850

Selects GSM 850 as the active channel band.

Key Path	Source, Frequency, Radio Setup, Radio Standard, GSM/EDGE
Example	:SOUR:FREQ:CHAN:BAND GSM850
Initial S/W Revision	A.05.00

GSM 700

Selects GSM 700 as the active channel band.

Key Path	Source, Frequency, Radio Setup, Radio Standard, GSM/EDGE
Example	:SOUR:FREQ:CHAN:BAND GSM700
Initial S/W Revision	A.05.00

T-GSM 810

Selects T-GSM 810 as the active channel band.

Key Path	Source, Frequency, Radio Setup, Radio Standard, GSM/EDGE
Example	:SOUR:FREQ:CHAN:BAND T-GSM810
Initial S/W Revision	A.05.00

WCDMA

Sets WCDMA as the radio standard for use and accesses the W-CDMA specific channel band sub-menus.

Key Path	Source, Frequency, Radio Setup, Radio Standard
Initial S/W Revision	A.05.00

Band I

Selects Band I as the active channel band.

Key Path	Source, Frequency, Radio Setup, Radio Standard, WCDMA
Example	:SOUR:FREQ:CHAN:BAND BANDI
Initial S/W Revision	A.05.00

Band II

Selects Band II as the active channel band.

Key Path	Source, Frequency, Radio Setup, Radio Standard, WCDMA
Example	:SOUR:FREQ:CHAN:BAND BANDII
Initial S/W Revision	A.05.00

Band III

Selects Band III as the active channel band.

Key Path	Source, Frequency, Radio Setup, Radio Standard, WCDMA
Example	:SOUR:FREQ:CHAN:BAND BANDIII
Initial S/W Revision	A.05.00

Band IV

Selects Band IV as the active channel band.

Key Path	Source, Frequency, Radio Setup, Radio Standard, WCDMA
Example	:SOUR:FREQ:CHAN:BAND BANDIV
Initial S/W Revision	A.05.00

Band V

Selects Band V as the active channel band.

Key Path	Source, Frequency, Radio Setup, Radio Standard, WCDMA
Example	:SOUR:FREQ:CHAN:BAND BANDV
Initial S/W Revision	A.05.00

Band VI

Selects Band VI as the active channel band.

Key Path	Source, Frequency, Radio Setup, Radio Standard, WCDMA
Example	:SOUR:FREQ:CHAN:BAND BANDVI
Initial S/W Revision	A.05.00

Band VII

Selects Band VII as the active channel band.

Key Path	Source, Frequency, Radio Setup, Radio Standard, WCDMA
Example	:SOUR:FREQ:CHAN:BAND BANDVII
Initial S/W Revision	A.05.00

Band VIII

Selects Band VIII as the active channel band.

Key Path	Source, Frequency, Radio Setup, Radio Standard, WCDMA
Example	:SOUR:FREQ:CHAN:BAND BANDVIII
Initial S/W Revision	A.05.00

Band IX

Selects Band IX as the active channel band.

Key Path	Source, Frequency, Radio Setup, Radio Standard, WCDMA
Example	:SOUR:FREQ:CHAN:BAND BANDIX
Initial S/W Revision	A.05.00

Band X

Selects Band X as the active channel band.

Key Path	Source, Frequency, Radio Setup, Radio Standard, WCDMA
Example	:SOUR:FREQ:CHAN:BAND BANDX
Initial S/W Revision	A.05.00

Band XI

Selects Band XI as the active channel band.

Key Path	Source, Frequency, Radio Setup, Radio Standard, WCDMA
Example	:SOUR:FREQ:CHAN:BAND BANDXI
Initial S/W Revision	A.05.00

Band XII

Selects Band XII as the active channel band.

Key Path	Source, Frequency, Radio Setup, Radio Standard, WCDMA
Example	:SOUR:FREQ:CHAN:BAND BANDXII
Initial S/W Revision	A.05.00

Band XIII

Selects band XIII as the active channel band.

Key Path	Source, Frequency, Radio Setup, Radio Standard, WCDMA
Example	:SOUR:FREQ:CHAN:BAND BANDXIII
Initial S/W Revision	A.05.00

Band XIV

Selects Band XIV as the active channel band.

Key Path	Source, Frequency, Radio Setup, Radio Standard, WCDMA
Example	:SOUR:FREQ:CHAN:BAND BANDXIV
Initial S/W Revision	A.05.00

LTE

Sets LTE FDD as the radio standard for use and accesses the LTE FDD specific channel band sub-menus..

Key Path	Source, Frequency, Radio Setup, Radio Standard
Initial S/W Revision	A.09.50

BAND 1

Selects BAND 1 as the band for the current step.

Key Path	Source, Frequency, Radio Setup, Radio Standard, LTE
----------	---

Example	:SOUR:FREQ:CHAN:BAND BAND1
Initial S/W Revision	A.09.50

BAND 2

Selects BAND 2 as the band for the current step.

Key Path	Source, Frequency, Radio Setup, Radio Standard, LTE
Example	:SOUR:FREQ:CHAN:BAND BAND2
Initial S/W Revision	A.09.50

BAND 3

Selects BAND 3 as the band for the current step.

Key Path	Source, Frequency, Radio Setup, Radio Standard, LTE
Example	:SOUR:FREQ:CHAN:BAND BAND3
Initial S/W Revision	A.09.50

BAND 4

Selects BAND 4 as the band for the current step.

Key Path	Source, Frequency, Radio Setup, Radio Standard, LTE
Example	:SOUR:FREQ:CHAN:BAND BAND4
Initial S/W Revision	A.09.50

BAND 5

Selects BAND 5 as the band for the current step.

Key Path	Source, Frequency, Radio Setup, Radio Standard, LTE
Example	:SOUR:FREQ:CHAN:BAND BAND5
Initial S/W Revision	A.09.50

BAND 6

Selects BAND 6 as the band for the current step.

Key Path	Source, Frequency, Radio Setup, Radio Standard, LTE
----------	---

Example	:SOUR:FREQ:CHAN:BAND BAND6
Initial S/W Revision	A.09.50

BAND 7

Selects BAND 7 as the band for the current step.

Key Path	Source, Frequency, Radio Setup, Radio Standard, LTE
Example	:SOUR:FREQ:CHAN:BAND BAND7
Initial S/W Revision	A.09.50

BAND 8

Selects BAND 8 as the band for the current step.

Key Path	Source, Frequency, Radio Setup, Radio Standard, LTE
Example	:SOUR:FREQ:CHAN:BAND BAND8
Initial S/W Revision	A.09.50

BAND 9

Selects BAND 9 as the band for the current step.

Key Path	Source, Frequency, Radio Setup, Radio Standard, LTE
Example	:SOUR:FREQ:CHAN:BAND BAND9
Initial S/W Revision	A.09.50

BAND 10

Selects BAND 10 as the band for the current step.

Key Path	Source, Frequency, Radio Setup, Radio Standard, LTE
Example	:SOUR:FREQ:CHAN:BAND BAND10
Initial S/W Revision	A.09.50

BAND 11

Selects BAND 11 as the band for the current step.

Key Path	Source, Frequency, Radio Setup, Radio Standard, LTE
----------	---

Example	:SOUR:FREQ:CHAN:BAND BAND11
Initial S/W Revision	A.09.50

BAND 12

Selects BAND 12 as the band for the current step.

Key Path	Source, Frequency, Radio Setup, Radio Standard, LTE
Example	:SOUR:FREQ:CHAN:BAND BAND12
Initial S/W Revision	A.09.50

BAND 13

Selects BAND 13 as the band for the current step.

Key Path	Source, Frequency, Radio Setup, Radio Standard, LTE
Example	:SOUR:FREQ:CHAN:BAND BAND13
Initial S/W Revision	A.09.50

BAND 14

Selects BAND 14 as the band for the current step.

Key Path	Source, Frequency, Radio Setup, Radio Standard, LTE
Example	:SOUR:FREQ:CHAN:BAND BAND14
Initial S/W Revision	A.09.50

BAND 17

Selects BAND 17 as the band for the current step.

Key Path	Source, Frequency, Radio Setup, Radio Standard, LTE
Example	:SOUR:FREQ:CHAN:BAND BAND17
Initial S/W Revision	A.09.50

BAND 18

Selects BAND 18 as the band for the current step.

Key Path	Source, Frequency, Radio Setup, Radio Standard, LTE
----------	---

Example	:SOUR:FREQ:CHAN:BAND BAND18
Initial S/W Revision	A.09.50

BAND 19

Selects BAND 19 as the band for the current step.

Key Path	Source, Frequency, Radio Setup, Radio Standard, LTE
Example	:SOUR:FREQ:CHAN:BAND BAND19
Initial S/W Revision	A.09.50

BAND 20

Selects BAND 20 as the band for the current step.

Key Path	Source, Frequency, Radio Setup, Radio Standard, LTE
Example	:SOUR:FREQ:CHAN:BAND BAND20
Initial S/W Revision	A.09.50

BAND 21

Selects BAND 21 as the band for the current step.

Key Path	Source, Frequency, Radio Setup, Radio Standard, LTE
Example	:SOUR:FREQ:CHAN:BAND BAND21
Initial S/W Revision	A.09.50

BAND 24

Selects BAND 24 as the band for the current step.

Key Path	Source, Frequency, Radio Setup, Radio Standard, LTE
Example	:SOUR:FREQ:CHAN:BAND BAND24
Initial S/W Revision	A.09.50

BAND 25

Selects BAND 25 as the band for the current step.

Key Path	Source, Frequency, Radio Setup, Radio Standard, LTE
----------	---

Example	:SOUR:FREQ:CHAN:BAND BAND25
Initial S/W Revision	A.09.50

BAND 26

Selects BAND 26 as the band for the current step.

Key Path	Source, Frequency, Radio Setup, Radio Standard, LTE
Example	:SOUR:FREQ:CHAN:BAND BAND26
Initial S/W Revision	A.12.53

BAND 27

Selects BAND 27 as the band for the current step.

Key Path	Source, Frequency, Radio Setup, Radio Standard, LTE
Example	:SOUR:FREQ:CHAN:BAND BAND27
Initial S/W Revision	A.14.00

BAND 28

Selects BAND 28 as the band for the current step.

Key Path	Source, Frequency, Radio Setup, Radio Standard, LTE
Example	:SOUR:FREQ:CHAN:BAND BAND28
Initial S/W Revision	A.14.00

BAND 31

Selects BAND 31 as the band for the current step.

Key Path	Source, Frequency, Radio Setup, Radio Standard, LTE
Example	:SOUR:FREQ:CHAN:BAND BAND31
Initial S/W Revision	A.14.00

LTE TDD

Sets LTE TDD as the radio standard for use and accesses the LTE TDD specific channel band sub-menus..

Key Path	Source, Frequency, Radio Setup, Radio Standard
Initial S/W Revision	A.11.50

BAND 33

Selects BAND 33 as the band for the current step.

Key Path	Source, Frequency, Radio Setup, Radio Standard, LTE TDD
Example	:SOUR:FREQ:CHAN:BAND BAND33
Initial S/W Revision	A.11.50

BAND 34

Selects BAND 34 as the band for the current step.

Key Path	Source, Frequency, Radio Setup, Radio Standard, LTE TDD
Example	:SOUR:FREQ:CHAN:BAND BAND34
Initial S/W Revision	A.11.50

BAND 35

Selects BAND 35 as the band for the current step.

Key Path	Source, Frequency, Radio Setup, Radio Standard, LTE TDD
Example	:SOUR:FREQ:CHAN:BAND BAND35
Initial S/W Revision	A.11.50

BAND 36

Selects BAND 36 as the band for the current step.

Key Path	Source, Frequency, Radio Setup, Radio Standard, LTE TDD
Example	:SOUR:FREQ:CHAN:BAND BAND36
Initial S/W Revision	A.11.50

BAND 37

Selects BAND 37 as the band for the current step.

Key Path	Source, Frequency, Radio Setup, Radio Standard, LTE TDD
Example	:SOUR:FREQ:CHAN:BAND BAND37
Initial S/W Revision	A.11.50

BAND 38

Selects BAND 38 as the band for the current step.

Key Path	Source, Frequency, Radio Setup, Radio Standard, LTE TDD
Example	:SOUR:FREQ:CHAN:BAND BAND38
Initial S/W Revision	A.11.50

BAND 39

Selects BAND 39 as the band for the current step.

Key Path	Source, Frequency, Radio Setup, Radio Standard, LTE TDD
Example	:SOUR:FREQ:CHAN:BAND BAND39
Initial S/W Revision	A.11.50

BAND 40

Selects BAND 40 as the band for the current step.

Key Path	Source, Frequency, Radio Setup, Radio Standard, LTE TDD
Example	:SOUR:FREQ:CHAN:BAND BAND40
Initial S/W Revision	A.11.50

BAND 41

Selects BAND 41 as the band for the current step.

Key Path	Source, Frequency, Radio Setup, Radio Standard, LTE TDD
Example	:SOUR:FREQ:CHAN:BAND BAND41
Initial S/W Revision	A.11.50

BAND 42

Selects BAND 42 as the band for the current step.

Key Path	Source, Frequency, Radio Setup, Radio Standard, LTE TDD
Example	:SOUR:FREQ:CHAN:BAND BAND42
Initial S/W Revision	A.11.50

BAND 43

Selects BAND 43 as the band for the current step.

Key Path	Source, Frequency, Radio Setup, Radio Standard, LTE TDD
Example	:SOUR:FREQ:CHAN:BAND BAND43
Initial S/W Revision	A.11.50

BAND 44

Selects BAND 44 as the band for the current step.

Key Path	Source, Frequency, Radio Setup, Radio Standard, LTE TDD
Example	:SOUR:FREQ:CHAN:BAND BAND44
Initial S/W Revision	A.14.00

TDSCDMA

Sets TDSCDMA as the radio standard for use and accesses the TDSCDMA specific channel band sub-menus..

Key Path	Source, Frequency, Radio Setup, Radio Standard
Initial S/W Revision	A.11.50

BAND A

Selects BAND A as the band for the current step.

Key Path	Source, Frequency, Radio Setup, Radio Standard, TDSCDMA
Example	:SOUR:FREQ:CHAN:BAND BANDA
Initial S/W Revision	A.11.50

BAND B

Selects BAND B as the band for the current step.

Key Path	Source, Frequency, Radio Setup, Radio Standard, TDSCDMA
Example	:SOUR:FREQ:CHAN:BAND BANDB
Initial S/W Revision	A.11.50

BAND C

Selects BAND C as the band for the current step.

Key Path	Source, Frequency, Radio Setup, Radio Standard, TDSCDMA
Example	:SOUR:FREQ:CHAN:BAND BANDC
Initial S/W Revision	A.11.50

BAND D

Selects BAND D as the band for the current step.

Key Path	Source, Frequency, Radio Setup, Radio Standard, TDSCDMA
Example	:SOUR:FREQ:CHAN:BAND BANDD
Initial S/W Revision	A.11.50

BAND E

Selects BAND E as the band for the current step.

Key Path	Source, Frequency, Radio Setup, Radio Standard, TDSCDMA
Example	:SOUR:FREQ:CHAN:BAND BANDE
Initial S/W Revision	A.11.50

BAND F

Selects BAND F as the band for the current step.

Key Path	Source, Frequency, Radio Setup, Radio Standard, TDSCDMA
Example	:SOUR:FREQ:CHAN:BAND BANDF
Initial S/W Revision	A.11.50

Radio Band Link

Allows you to specify the channel band type as either uplink or downlink link direction. This value is used in conjunction with the channel band and channel number to determine the absolute frequency output by the source. When set to "Uplink", the source will calculate the uplink frequency using an uplink formula together with the selected channel band and channel number. When set to "Downlink", the source will calculate the downlink frequency using a downlink formula together with the selected channel band and channel number.

Key Path	Source, Frequency, Radio Setup
Remote Command	:SOURce:RADio:BAND:LINK DOWN UP :SOURce:RADio:BAND:LINK?

Example	:SOUR:RAD:BAND:LINK UP
Preset	DOWN
Range	DOWN UP
Backwards Compatibility SCPI	:SOURce:RADio:DEVIce BTS MS
	:SOURce:RADio:DEVIce?
Backwards Compatibility Notes	BTS maps to the Downlink frequency MS maps to the Uplink frequency
Initial S/W Revision	A.05.00

Set Reference Frequency

This key allows you to set the frequency reference. Pressing this key turns the frequency reference state to ON, sets the reference frequency value to the current frequency, maintains this frequency at the RF output, and sets the displayed frequency to 0.00 Hz. All subsequent frequencies entered under Source>Frequency>Frequency are interpreted as being relative to this reference frequency.

When you use a frequency reference, the signal generator outputs a frequency that is set relative to the reference frequency by the value entered under Source>Frequency>Frequency as follows:

Output frequency = reference frequency - entered frequency

Where:

reference frequency equals the original RF frequency entered under Source>Frequency>Frequency and set as the reference frequency

entered frequency equals a new value entered under Source>Frequency>Frequency

In addition, the displayed frequency value will be the same as the value entered under Source>Frequency>Frequency.

NOTE

If Freq Reference is set to ON with a reference value set, entering a value under Source>Frequency>Frequency and pressing Set Frequency Reference will add that value to the existing Freq Reference value.

If you wish to change the reference frequency value to the new value entered under Source>Frequency>Frequency, first you must set Freq Reference to OFF and then press Set Frequency Reference.

Key Path	Source, Frequency
Remote Command	:SOURce:FREQuency:REFerence:SET
Example	:SOUR:FREQ:REF:SET
Dependencies	This setting is unavailable, and is grayed out when the List Sequencer is turned ON.
Initial S/W Revision	A.05.00

Freq Reference

This key allows you to toggle the state of the frequency reference. When the frequency reference state is ON, an annunciator is displayed on the main source view to indicate this state to the user.

When you use a frequency reference, the signal generator outputs a frequency that is set relative to the reference frequency by the value entered under Source>Frequency>Frequency as follows:

Output frequency = reference frequency + entered frequency

Where:

reference frequency equals the original RF frequency entered under Source>Frequency>Frequency and set as the reference frequency

entered frequency equals a new value entered under Source>Frequency>Frequency

For more information on Reference Frequency refer to ["Set Reference Frequency" on page 2127](#)

Key Path	Source, Frequency
Remote Command	:SOURce:FREQuency:REFerence <freq> :SOURce:FREQuency:REFerence? :SOURce:FREQuency:REFerence:STATe OFF ON 0 1 :SOURce:FREQuency:REFerence:STATe?
Example	:SOUR:FREQ:REF 0.00 Hz :SOUR:FREQ:REF:STATe ON
Dependencies	This setting is unavailable, and is grayed out when the List Sequencer is turned ON.
Couplings	The frequency reference state is coupled to the frequency reference set immediate action. When the reference set immediate action key is pressed, or the SCPI command issued, it turns the frequency reference state ON.
Preset	0.00 Hz OFF
Min	0.00 Hz
Max	Hardware Dependant: Option 503 = 3.6 GHz Option 504 = 3.8 GHz Option 506 = 6.00 GHz
Initial S/W Revision	A.05.00

Freq Offset

Allows you to specify the frequency offset value. When the frequency offset state is ON, an annunciator is displayed on the main source view to indicate this state to the user.

When the frequency offset is set to zero (0) and you set a new offset value, the displayed frequency value will change as follows and the RF output frequency will not change:

Displayed value = output frequency + offset value

Where:

output frequency equals the original frequency entered under Source>Frequency>Frequency

offset value equals the value entered under Source>Frequency>Freq Offset

When the frequency offset is set to a value other than zero (0) and you enter a new frequency value under Source>Frequency>Frequency, the displayed frequency will be the same as the value entered and the RF output frequency will be equal to the value entered minus the offset value as follows:

Output frequency = entered frequency – offset frequency

Displayed frequency = output frequency + offset frequency

Displayed frequency = entered frequency

Where:

entered frequency equals the frequency entered under Source>Frequency>Frequency

offset frequency equals the value previously entered and set under Source>Frequency>Freq Offset

Key Path	Source, Frequency
Remote Command	:SOURce:FREQuency:OFFSet <freq> :SOURce:FREQuency:OFFSet?
Example	:SOUR:FREQ:OFFS 0 Hz
Dependencies	This setting is unavailable, and is grayed out when the List Sequencer is turned ON.
Preset	0 Hz
Min	-100.00 GHz
Max	100.00 GHz
Initial S/W Revision	A.05.00

Modulation Setup

Allows access to the menus for setting up the available modulation types: "ARB" on page 2143, "AM" on page 2164, "FM" on page 2165, and "PM" on page 2167.

Key Path	Source
Initial S/W Revision	A.05.00

ARB

Allows you access to the ARB sub-menus.

Key Path	Source, Modulation Setup
Initial S/W Revision	A.05.00

ARB

Allows you to toggle the state of the ARB function. When the ARB is On, a “MOD” annunciator is displayed in the system settings panel. When the ARB is turned Off, the MOD annunciator is cleared

Key Path	Source, Modulation Setup, ARB
Remote Command	:SOURce:RADio:ARB[:STATe] ON OFF 1 0 :SOURce:RADio:ARB[:STATe]?
Example	:SOUR:RAD:ARB OFF :SOUR:RAD:ARB?
Notes	If the ARB is ON, a user then loads or deletes another file to ARB memory, the playing waveform segment may not keep phase continuity during the ARB memory operation. The waveform will be replayed after the ARB operation is finished.
Dependencies	This setting is for independent mode and has no effect on 3.3.8 list sequencer mode. Setting "Sequencer" on page 2168 Sequencer to On will put source enter list sequencer mode, and even if ARB state is On, the ARB file will not be played. Setting "Sequencer" on page 2168 Sequencer to Off will make source leave list sequencer mode, and this setting will take effect immediately. The ARB can only be turned on when there is a waveform file selected for playback. On the GUI if no waveform is selected, this key is grayed out. If you send the SCPI command to turn the ARB on with no waveform selected for playback, the ARB state remains OFF and an error is generated. "- When you try to recall a certain set of states in which the selected waveform is not in ARB memory and the ARB state is On, errors are reported
Preset	Off
Range	On Off
Initial S/W Revision	A.05.00

Select Waveform

Allows you to access to the waveform selection sub-menus.

Pressing this key changes the central view area to show the Waveform File Selection view.

Key Path	Source, Modulation Setup, ARB
Initial S/W Revision	A.05.00

Select Waveform

Allows you to select a waveform sequence or segment for the dual ARB to play.

NOTE: Selecting a waveform file does not result in automatic adjustments to burst timing (to compensate for the presence or absence of a Multiport Adapter); that adjustment occurs only when a waveform is loaded to ARB memory. See "Load Segment to ARB Memory" for more information about this adjustment.

Key Path	Source, Modulation Setup, ARB, Select Waveform
Remote Command	:SOURce:RADio:ARB:WAVeform <string> :SOURce:RADio:ARB:WAVeform?
Example	:SOUR:RAD:ARB:WAV "test_waveform.bin"
Notes	<p>If intended waveform is not in the memory yet, then issuing this command by SCPI will invoke ARB loading operation first, which involves a delay of unpredictable length. So this command should be followed by the query *OPC?, which holds off subsequent commands until the loading operation is complete.</p> <p><string> - specifies the name of the waveform segment or waveform sequence to be played by the ARB.</p> <p>When in Sequence Analyzer mode, and Include Source is Yes, if you attempt to play a waveform sequence but not all the required waveform segments are in the ARB playback memory, the application will reject the loading operation with an error is generated .</p> <p>When Include Source is No, if you attempt to play a waveform sequence but not all the required waveform segments are contained in the ARB playback memory, the application will attempt to load the required segments from either the default directory of the current directory. If the ARB memory does not have enough space for all the waveform segments to be loaded, an error is generated and none of the waveform segments is loaded.</p> <p>If the ARB is ON, and you attempt to play a waveform sequence but not all the waveform segments within the sequence could be found to be loaded into ARB memory, an error is generated. The selected waveform keeps the previous value and ARB state remains On.</p> <p>If you specify a waveform segment over SCPI but the waveform segment is not present within ARB playback memory and cannot be found for auto loading within the current directory or the default directory, an error is generated and the file selection remains unchanged.</p> <p>If you select a waveform for playback and the waveform requires a license that is not installed on the instrument, an error is generated.</p> <p>If the ARB is ON and you load a file to ARB memory or delete a file from ARB memory, the playing waveform segment may not keep phase continuity during the ARB memory operation. The waveform will be replayed after the ARB operation is finished.</p>
Initial S/W Revision	A.05.00

Segments on Hard Disk

Allows you access to the sub-menus for loading waveform segments from the hard disk into ARB memory. The default directory is: D: varb.

Pressing this key changes the current view to the Waveform Management View.

Key Path	Source, Modulation Setup, ARB, Select Waveform
Initial S/W Revision	A.05.00

Load Segment To ARB Memory

Allows you to load the selected file into ARB memory. On the front panel you select the file for loading to the ARB memory by highlighting the desired file in the list. Using the SCPI command, you specify the file

name on the HDD.

“NVWFM” (none-volatile storage) MSUS (Mass Storage Unit Specifier) is supported in the memory subsystem because the ARB memory cannot be accessed directly. Therefore, files must be downloaded to the instrument hard disk and then loaded into the ARB memory. “NVWFM” MSUS will be mapped to the default directory D: VARB. The SCPI command supports using either “NVWFM” MSUS or specifying a full path. For more information, see Memory Subsystem (Remote Command Only).

If a file of the same name already exists within ARB memory, it is overwritten. If you wish to load two segments of the same name, you must rename one of the segments before loading it into ARB memory. To rename a segment, you can either use Windows File Explorer, or the :MMEMORY:COPY command.

NOTE: When a waveform file is loaded to ARB memory, burst timing adjustments are made automatically, based on whether or not a Multiport Adapter is connected to the test set and powered on. If the connection/power status of the Multiport Adapter is changed after a waveform file has been loaded, it needs to be loaded again.

Key Path	Source, Modulation Setup, ARB, Select Waveform, Segments on Hard Disk
Remote Command	:SOURCE:RADio:ARB:LOAD <string>
Example	:SOUR:RAD:ARB:LOAD "D: VARB\testwaveform.bin" or :SOUR:RAD:ARB:LOAD "NVWFM:testwaveform.bin"
Notes	<p>Because loading the file involves a delay of unpredictable length, this command should be followed by the query *OPC?, which holds off subsequent commands until the loading operating is complete.</p> <p><string> - specifies the path name of the file to load from the HDD into ARB memory. It could be a <full path + filename>, or <"NVWFM" MSUS + colon + filename>.</p> <p>When in Sequence Analyzer mode, and Include Source is Yes, an attempt to load a file to ARB memory will be rejected with an error.</p> <p>When Include Source is No and if there is insufficient free ARB memory to load the selected waveform, an error is generated. .</p> <p>If you specify a file over SCPI, but the file is not at the specified location, an error is generated.</p> <p>If you try to load a waveform file but the file contains less than 500 IQ samples, an error is generated.</p> <p>If you try to load a Signal Studio waveform "*.wfm" which contains invalid waveform header, an error is generated.</p> <p>If the ARB is ON when you load a file to ARB memory or delete a file from ARB memory, the playing waveform segment may not keep phase continuity during the ARB memory operation. The waveform will be replayed after the ARB operation is finished.</p> <p>ARB can be loaded into ARB memory even required licenses do not present on the instrument. In this case, a GUI only warning message -800, "Operation complete; Loaded <filename> successfully, but no license <required licenses> installed". User can install required licenses according to <required licenses> string to license it, or multi-pack license it.</p>
Initial S/W Revision	A.05.00

Load All To ARB Memory

Allows you to load all the segment files within the currently selected directory into ARB memory. If a file of the same name already exists within ARB memory, it is overwritten. If you wish to load two segments of the

same name, you must rename one of the segments before loading it into ARB memory. To rename a segment, you can either use Windows File Explorer, or the :MEMory:COpy command.

NOTE: When a waveform file is loaded to ARB memory, burst timing adjustments are made automatically, based on whether or not a Multiport Adapter is connected to the test set and powered on. If the connection/power status of the Multiport Adapter is changed after a waveform file has been loaded, it needs to be loaded again.

Key Path	Source, Modulation Setup, ARB, Select Waveform, Segments on Hard Disk
Remote Command	:SOURce:RADio:ARB:LOAD:ALL <string>
Example	:SOUR:RAD:ARB:LOAD:ALL "D: varb"
Notes	<p><string> - specifies the directory on the HDD to load the files into ARB memory from.</p> <p>When in Sequence Analyzer mode, and Include Source is Yes, an attempt to load all files from a directory to ARB memory is rejected with an error.</p> <p>When Include Source is No and there is insufficient free ARB memory to load all the waveforms, when the ARB memory is full, the copy ceases, and an error is generated.</p> <p>If you specify a directory over SCPI, but the directory does not exist, an error is generated.</p> <p>If the ARB is ON, a user then loads or deletes file to ARB memory, the playing waveform segment may not keep phase continuity during the ARB memory operation. The waveform will be replayed after the ARB operation is finished.</p>
Initial S/W Revision	A.05.00

Change Directory...

Allows you to change the currently selected directory on the hard disk. Pressing this key opens a standard windows change directory dialog allowing you to select the new directory of interest.

The current directory is used for manually loading waveform segments into ARB memory for playback, and as a search location for waveform segments that are required to be loaded into ARB memory for playback of a waveform sequence or a list sequence.

Key Path	Source, Modulation Setup, ARB, Select Waveform, Segments on Hard Disk
Notes	No remote command, SCPI front panel only.
Initial S/W Revision	A.05.00

Default Directory...

Allows you to change the default directory. It is used as a search location for waveform segments that are required to be loaded into ARB memory for playback of a waveform sequence, and as a search location for selecting waveforms using SCPI.

Key Path	Source, Modulation Setup, ARB, Select Waveform, Segments on Hard Disk
Remote Command	:SOURce:RADio:ARB:DEFault:DIRectory <string> :SOURce:RADio:ARB: DEFault:DIRectory?
Example	:SOUR:RAD:ARB:DEF:DIR "D:\ArbFiles"

	:SOUR:RAD:ARB:DEF:DIR?
State Saved	Persistent, survives a power cycle and a preset but not saved in the instrument state
Initial S/W Revision	A.05.00

Segments in ARB Memory

Allows you access to the sub-menus for managing the files within ARB memory.

Key Path	Source, Modulation Setup, ARB, Select Waveform
Initial S/W Revision	A.05.00

Delete Segment From ARB Mem

Allows you to remove a segment from ARB playback memory.

Key Path	Source, Modulation Setup, ARB, Select Waveform, Segments in ARB Memory
Remote Command	:SOURce:RADio:ARB:DELeTe <string>
Example	:SOUR:RAD:ARB:DEL "testwaveform.bin"
Notes	<p><string> - specifies the waveform to be deleted from the ARB playback memory.</p> <p>When in Sequence Analyzer mode and Include Source is Yes, an attempt to delete a file from ARB memory is rejected with an error.</p> <p>When Include Source is No and you specify a file that does not exist within ARB memory, an error is generated.</p> <p>It is possible to delete files from within the ARB memory when the ARB is ON. However, if you attempt to delete the file that is currently playing an error is generated.</p> <p>It is possible to delete a file from within the ARB memory when the sequencer state is ON and the file is not being used by the List Sequencer. If you attempt to delete a file which is being used by the list sequencer, an error is generated.</p> <p>When sequencer state is On, even if ARB state is On, the selected waveform will not be played. In this case, if the selected waveform is not used in List Sequence, it can be deleted and the ARB state is turned Off.</p> <p>If the ARB is ON and you load a file to ARB memory or delete a file from ARB memory, the playing waveform segment may not keep phase continuity during the ARB memory operation. The waveform will be replayed after the ARB operation is finished.</p>
Initial S/W Revision	A.05.00

Delete All From ARB Memory

Allows you to remove all segments from ARB playback memory.

Key Path	Source, Modulation Setup, ARB, Select Waveform, Segments in ARB Memory
----------	--

Remote Command	:SOURce:RADio:ARB:DELeTe:ALL
Example	:SOUR:RAD:ARB:DELeTe:ALL
Notes	<p>When in Sequence Analyzer mode and Include Source is Yes, an attempt to delete all files from ARB memory is rejected with an error.</p> <p>When Include Source is No and you attempt to delete all files from ARB memory when the ARB is currently playing a file, all files except the one playing are deleted and an error is generated.</p> <p>If you attempt to delete all files from ARB memory when there are waveform files used in "List Sequencer" on page 2168 and "Sequencer" on page 2168 state is ON, all files except the files currently being used in list sequencer are deleted, and an error is generated.</p> <p>If the ARB is ON and you load a file to ARB memory or delete a file from ARB memory, the playing waveform segment may not keep phase continuity during the ARB memory operation. The waveform will be replayed after the ARB operation is finished.</p>
Initial S/W Revision	A.05.00

ARB Setup

Allows access to the ARB setup sub-menus.

Key Path	Source, Modulation Setup, ARB
Initial S/W Revision	A.05.00

Sample Rate

Allows you to set the ARB waveform playback sample rate.

Key Path	Source, Modulation Setup, ARB, ARB Setup
Remote Command	:SOURce:RADio:ARB:SCLock:RATE <freq> :SOURce:RADio:ARB:SCLock:RATE?
Example	:SOUR:RAD:ARB:SCL:RATE 48.00 MHz
Notes	If there is a sample rate specified in the header of the waveform file, changing that sample rate is not recommended, as it may cause problems with burst timing.
Dependencies	When a new waveform is selected for playback the settings contained within the associated waveform header file are applied to the ARB. The sample rate is one of the values stored within the header file. If the newly selected waveform file has an associated header file, the sample rate is updated with the value from the header file. The sample rate will remain unchanged if the newly selected waveform does not have an associated header file.
Preset	125.00 MHz
Min	1.00 kHz
Max	125.00 MHz
Initial S/W Revision	A.05.00

Run-Time Scaling

Allows you to adjust the run-time scaling value. The run-time scaling value is applied in real-time while the waveform is playing.

Key Path	Source, Modulation Setup, ARB, ARB Setup
Remote Command	:SOURce:RADio:ARB:RSCaling <real> :SOURce:RADio:ARB:RSCaling?
Example	:SOUR:RAD:ARB:RSC 100.00
Notes	This setting cannot be set in E6640A/M9420A. Grey out on menu and the value is fixed at 70.00%.
Dependencies	When a new waveform is selected for playback the settings contained within the associated waveform header file are applied to the ARB. The run-time scaling is one of the values stored within the header file. If the newly selected waveform file has an associated header file, the run-time scaling is updated with the value from the header file. The run-time scaling will remain unchanged if the newly selected waveform does not have an associated header file.
Preset	70.00 %
Min	1.00 %
Max	100.00 %
Initial S/W Revision	A.05.00

Baseband Freq Offset

Allows you to adjust the value by which the baseband frequency is offset relative to the carrier.

Key Path	Source, Modulation Setup, ARB, ARB Setup
Remote Command	:SOURce:RADio:ARB:BASEband:FREQuency:OFFSet <freq> :SOURce:RADio:ARB:BASEband:FREQuency:OFFSet?
Example	:SOUR:RAD:ARB:BAS:FREQ:OFFS 0.00 Hz
Dependencies	When a new waveform is selected for playback the settings contained within the associated waveform header file are applied to the ARB. The baseband frequency offset is one of the values stored within the header file. If the newly selected waveform file has an associated header file, the baseband frequency offset is updated with the value from the header file. The baseband frequency offset will remain unchanged if the newly selected waveform does not have an associated header file.
Preset	0.00 Hz
Min	-50.00 MHz
Max	50.00 MHz
Initial S/W Revision	A.05.00

Edit RMS

Allows you to edit or calculate current RMS of selected waveform.

Key Path	Source, Modulation Setup, ARB, ARB Setup
Initial S/W Revision	A.14.50

Current RMS

Allows you to directly specify current RMS value used to playback currently selected waveform. Please note incorrect RMS value may cause inaccurate power output in E6640A/M9420A that is sensitive to RMS value.

This setting is also updated by RMS in waveform header or updated when invoking RMS calculation operation.

This setting can be saved to the header of currently selected waveform by invoking ["Save Setup To Header" on page 2164](#) "Save Setup To Header".

Key Path	Source, Modulation Setup, ARB, ARB Setup, Edit RMS
Remote Command	:SOURce:RADio:ARB:RMS <float> :SOURce:RADio:ARB:RMS?
Example	:SOUR:RAD:ARB:HEAD:RMS 0.7 :SOUR:RAD:ARB:HEAD:RMS?
Notes	Valid range is 0 to 1.414, values outside the range will be clipped to the closest boundary. Note this value does not affect "List Sequencer" on page 2168 Source List Sequencer that always uses RMS value resides in each ARB header. If want this value to take effect in list sequencer, use "Save Setup To Header" on page 2164 "Save Setup to Header" to save current RMS value to header first, then play the ARB in source list sequencer.
Dependencies	When a new waveform is selected for playback, this setting is updated by the RMS value defined in associated waveform header file. If selected waveform has no associated header file or header file does not specify RMS value, then instrument will try to calculate out one automatically. Calculating RMS can also update this setting.
Preset	0
Range	0 ~ 1.414
Initial S/W Revision	A.14.50

RMS Calculation Mode

Allows you to specify the mode to calculate the current RMS.

Key Path	Source, Modulation Setup, ARB, ARB Setup, Edit RMS
Remote Command	:SOURce:RADio:ARB:RMS:CALCulation:MODE AUTO M1 M2 M3 M4 :SOURce:RADio:ARB:RMS:CALCulation:MODE?
Example	:SOUR:RAD:ARB:RMS:CALC:MODE AUTO
Notes	If no waveform is selected, or selected waveform is waveform sequence, the key will grey out.

Preset	AUTO
Range	AUTO M1 M2 M3 M4
Initial S/W Revision	A.14.50

Auto

RMS will be calculated based on the whole sample range of current selected waveform.

Key Path	Source, Modulation Setup, ARB, ARB Setup, Edit RMS, Calculate RMS, RMS Calculation Mode
Example	:SOUR:RAD:ARB:RMS:CALC:MODE AUTO
Initial S/W Revision	A.14.50

Marker 1

Selects marker 1 to designate sample range used for RMS calculation.

Key Path	Source, Modulation Setup, ARB, ARB Setup, Edit RMS, Calculate RMS, RMS Calculation Mode , Marker
Example	:SOUR:RAD:ARB:RMS:CALC:MODE M1
Initial S/W Revision	A.14.50

Marker 2

Selects marker 2 to designate sample range used for RMS calculation.

Key Path	Source, Modulation Setup, ARB, ARB Setup, Edit RMS, Calculate RMS, RMS Calculation Mode , Marker
Example	:SOUR:RAD:ARB:RMS:CALC:MODE M2
Initial S/W Revision	A.14.50

Marker 3

Selects marker 3 to designate sample range used for RMS calculation.

Key Path	Source, Modulation Setup, ARB, ARB Setup, Edit RMS, Calculate RMS, RMS Calculation Mode , Marker
Example	:SOUR:RAD:ARB:RMS:CALC:MODE M3
Initial S/W Revision	A.14.50

Marker 4

Selects marker 4 to designate sample range used for RMS calculation.

Key Path	Source, Modulation Setup, ARB, ARB Setup, Edit RMS, Calculate RMS, RMS Calculation Mode , Marker
Example	:SOUR:RAD:ARB:RMS:CALC:MODE M4
Initial S/W Revision	A.14.50

Calculate RMS

Allows you to calculate current RMS based on mode selected. This will update "[Current RMS](#)" on page 2137 Current RMS setting.

Key Path	Source, Modulation Setup, ARB, ARB Setup, Edit RMS, Calculate RMS
Remote Command	:SOURce:RADio:ARB:RMS:CALCulate
Example	:SOUR:RAD:ARB:RMS:CALC
Notes	<p>If no waveform is selected, invoking this operation will get error “-221 Setting conflict; No waveform is selected for RMS operation”.</p> <p>If no waveform is selected, or selected waveform is waveform sequence, the key will grey out.</p> <p>If selected waveform does not contain marker data, but "RMS Calculation Mode" on page 2137 “RMS Calculation Mode” is set to marker, under this circumstance, invoking calculation operation will get error “-221 Setting conflict; There is no marker for currently selected waveform, auto RMS calculation mode is used instead”, and "RMS Calculation Mode" on page 2137 “RMS Calculation Mode” will be coupled to “Auto” mode automatically.</p> <p>RMS calculation does not suit for waveform sequence. If selected waveform is waveform sequence file, invoking this operation will get error “-221 Setting conflict; RMS calculation does not apply to waveform sequence”. But users can still edit current RMS as play parameter, and can save current RMS to waveform sequence header for later use.</p>
Initial S/W Revision	A.14.50

Use Header RMS

Allows you to quickly set RMS in ARB header to "[Current RMS](#)" on page 2137 Current RMS setting.

Key Path	Source, Modulation Setup, ARB, ARB Setup, Edit RMS,
Notes	<p>No remote command, front panel only.</p> <p>If no waveform is selected, the key will grey out.</p> <p>If no waveform is selected, invoking this operation will get error “-221 Setting conflict; No waveform is selected for RMS operation”.</p>
Initial S/W Revision	A.14.50

Trigger Type

Allows access to the trigger type sub-menus. The setting for trigger type determines the behavior of the waveform when it plays.

Key Path	Source, Modulation Setup, ARB
Remote Command	:SOURce:RADio:ARB:TRIGger:TYPE CONTInuous SINGLE SADVance :SOURce:RADio:ARB:TRIGger:TYPE?
Example	:SOUR:RAD:ARB:TRIG:TYPE CONT :SOUR:RAD:ARB:TRIG:TYPE?
Notes	Gated trigger type will be implemented at a later release
Preset	CONTInuous
Range	Continuous Single Seg Adv
Initial S/W Revision	A.05.00

Continuous

Sets the active trigger type to Continuous. If Continuous is already selected as the active trigger type, pressing this key allows access to the continuous trigger type setup menu. In Continuous trigger mode, the waveform repeats continuously.

Key Path	Source, Modulation Setup, ARB, Trigger Type
Remote Command	:SOURce:RADio:ARB:TRIGger:TYPE:CONTInuous[:TYPE] FREE TRIGger RESet :SOURce:RADio:ARB:TRIGger:TYPE:CONTInuous[:TYPE]?
Example	:SOUR:RAD:ARB:TRIG:TYPE:CONT FREE
Preset	FREE
Range	Free Run Trigger + Run Reset + Run
Initial S/W Revision	A.05.00

Free Run

Selects Free Run as the trigger response for the continuous trigger type. Free Run sets the waveform generator to play a waveform sequence or segment continuously, without waiting for a trigger. In this mode, the waveform generator does not respond to triggers.

Key Path	Source, Modulation Setup, ARB, Trigger Type, Continuous
Example	:SOUR:RAD:ARB:TRIG:TYPE:CONT FREE
Initial S/W Revision	A.05.00

Trigger + Run

Sets Trigger and Run as the trigger response for the continuous trigger type. Trigger and Run sets the waveform generator to play a waveform sequence or segment continuously when the first trigger is received, and to ignore any subsequent triggers.

Key Path	Source, Modulation Setup, ARB, Trigger Type, Continuous
Example	:SOUR:RAD:ARB:TRIG:TYPE:CONT TRIG
Initial S/W Revision	A.05.00

Reset + Run

Sets Reset and Run as the trigger response for the continuous trigger type. Reset and Run sets the waveform generator to play a waveform sequence or segment continuously when the first trigger is received. Subsequent triggers reset the waveform sequence or segment to the start, and then play it continuously.

Key Path	Source, Modulation Setup, ARB, Trigger Type, Continuous
Example	:SOUR:RAD:ARB:TRIG:TYPE:CONT RES
Initial S/W Revision	A.05.00

Single

Sets the active trigger type to Single. If Single is already selected as the active trigger type, pressing this key allows access to the single trigger type setup menu. In Single trigger mode, the waveform plays once.

Key Path	Source, Modulation Setup, ARB, Trigger Type
Remote Command	:SOURce:RADio:ARB:RETRigger ON OFF IMMEDIATE :SOURce:RADio:ARB:RETRigger?
Example	:SOUR:RAD:ARB:RETR OFF
Notes	ON: Buffered Trigger OFF: No Retrigger Immediate: Restart on Trigger This is defined as an enumerated SCPI command, with ON OFF being considered as enumerated types rather than Boolean. This means the query will return OFF instead of 0, and ON instead of 1.
Preset	ON
Range	No Retrigger Buffered Trigger Restart on Trigger
Initial S/W Revision	A.05.00

No Retrigger

Selects No Retrigger as the trigger response for single trigger type. No Retrigger sets the waveform generator to play a waveform sequence or segment once when a trigger is received. Any triggers then

received during playback are ignored.

Key Path	Source, Modulation Setup, ARB, Trigger Type, Single
Example	:SOUR:RAD:ARB:RETR OFF
Initial S/W Revision	A.05.00

Buffered Trigger

Selects Buffered Trigger as the trigger response for single trigger type. Buffered Trigger sets the waveform generator to play a waveform sequence or segment once when a trigger is received. If a trigger is received during playback, the waveform generator plays the sequence or segment to the end, then plays the sequence or segment once more.

Key Path	Source, Modulation Setup, ARB, Trigger Type, Single
Example	:SOUR:RAD:ARB:RETR ON
Initial S/W Revision	A.05.00

Restart on Trigger

Selects Restart on Trigger as the trigger response for single trigger type. Restart on Trigger sets the waveform generator to play a waveform sequence or segment once when a trigger is received. If a trigger is received during playback, the waveform generator resets and plays the sequence or segment from the start.

Key Path	Source, Modulation Setup, ARB, Trigger Type, Single
Example	:SOUR:RAD:ARB:RETR IMM
Initial S/W Revision	A.05.00

Segment Advance

Sets the active trigger type to Segment Advance. If Segment Advance is already selected as the active trigger type, pressing this key allows access to the segment advance trigger type setup menu.

Segment Advance triggering allows you to control the playback of waveform segments within a waveform sequence. When a trigger is received the ARB advances to the next waveform segment within the waveform sequence. This type of triggering ignores the repetition count for the waveform segment within the waveform sequence. For example, if a waveform segment has a repetition count of 10 and you select single segment advance triggering mode, the waveform segment will only play once.

Segment Advance triggering can also be used for waveform segments only. In this situation the same waveform segment is played again when a trigger is received.

Key Path	Source, Modulation Setup, ARB, Trigger Type
Remote Command	:SOURce:RADio:ARB:TRIGger:TYPE:SADVance[:TYPE] SINGLE CONTInuous

	:SOURce:RADio:ARB:TRIGger:TYPE:SADVance[:TYPE]?
Example	:SOUR:RAD:ARB:TRIG:TYPE:SADV SING
Preset	CONTInuous
Range	Single Continuous
Initial S/W Revision	A.05.00

Single

Selects Single as the trigger response for Segment Advance trigger type. With single selected, once a trigger is received a segment is played once. If a trigger is received during playback of a segment, the segment plays to completion and the next segment is played once.

Key Path	Source, Modulation Setup, ARB, Trigger Type, Segment Advance
Example	:SOUR:RAD:ARB:TRIG:TYPE:SADV SING
Initial S/W Revision	A.05.00

Continuous

Selects Continuous as the trigger response for Segment Advance trigger type. With continuous selected, once a trigger is received a segment is played continuously. When subsequent triggers are received, the currently playing segment plays to completion and then the next segment is played continuously.

Key Path	Source, Modulation Setup, ARB, Trigger Type, Segment Advance
Example	:SOUR:RAD:ARB:TRIG:TYPE:SADV CONT
Initial S/W Revision	A.05.00

ARB

Allows you access to the ARB sub-menus.

Key Path	Source, Modulation Setup
Initial S/W Revision	A.05.00

Trigger Source

The trigger source setting determines how the source receives the trigger that starts the waveform playing. Therefore, this key is grayed out if the trigger type is free run, since free run triggers immediately with no trigger source required.

Key Path	Source, Modulation Setup, ARB
Remote Command	:SOURce:RADio:ARB:TRIGger[:SOURce] KEY BUS EXTernal2

	:SOURce:RADio:ARB:TRIGger[:SOURce]?
Example	:SOUR:RAD:ARB:TRIGger KEY
Dependencies	This key is grayed out if the current trigger type is Continuous, Free Run.
Preset	EXTernal2
Range	Trigger Key Bus External 2
Initial S/W Revision	A.05.00

Trigger Key

Sets the current trigger source to the front panel Trigger key. When Trigger Key is selected, the waveform is triggered when you press the front panel Trigger key.

Key Path	Source, Modulation Setup, ARB, Trigger Source
Example	:SOUR:RAD:ARB:TRIGger KEY
Initial S/W Revision	A.05.00

Bus

Sets the current trigger source to Bus. Selecting Bus trigger source enables triggering over GPIB, LAN, or USB using the :SOURce:RADio:ARB:TRIGger:INITiate command.

Key Path	Source, Modulation Setup, ARB, Trigger Source
Example	:SOUR:RAD:ARB:TRIGger BUS
Initial S/W Revision	A.05.00

External 2

Sets the current trigger source to External 2. Selecting External 2 enables triggering a waveform by an externally applied signal.

Key Path	Source, Modulation Setup, ARB, Trigger Source
Example	:SOUR:RAD:ARB:TRIGger EXT2
Notes	Note: When on E6640A, trigger 2 is a bi-directional trigger port. So when trigger 2 has been configured as OUTPUT type, choosing External 2 as the input trigger for the current step will generate error.
Initial S/W Revision	A.05.00

External Trigger Delay

This key allows you to toggle the state and value of external trigger delay. The value you enter sets a delay time between when an external trigger is received and when it is applied to the waveform. This is key is

active only if you select external trigger as trigger source.

Key Path	Source, Modulation Setup, ARB, Trigger Source
Remote Command	:SOURce:RADio:ARB:TRIGger[:SOURce]:EXTernal:DELay <time> :SOURce:RADio:ARB:TRIGger[:SOURce]:EXTernal:DELay? SOURce:RADio:ARB:TRIGger[:SOURce]:EXTernal:DELay:STATe OFF ON 0 1 :SOURce:RADio:ARB:TRIGger[:SOURce]:EXTernal:DELay:STATe?
Example	:SOUR:RAD:ARB:TRIG:EXT:DEL 100ns :SOUR:RAD:ARB:TRIG:EXT:DEL? :SOUR:RAD:ARB:TRIG:EXT:DEL:STAT ON :SOUR:RAD:ARB:TRIG:EXT:DEL:STAT?
Notes	External trigger delay time set by users will be rounded to the nearest integer multiple of the resolution.
Dependencies	This setting is unavailable and is grayed out when the Trigger Source is not set to external trigger.
Preset	1 ms OFF
Min	0 s
Max	8.589934588 s (Note: This value comes from $4\text{ns} * (2^{31} - 1) = 8589934588\text{ ns}$)
Initial S/W Revision	A.14.50

Trigger Initiate

Used to initiate an immediate trigger event if the trigger source is set to Trigger Key.

Key Path	Source, Modulation Setup, ARB
Notes	No remote command, SCPI front panel only.
Initial S/W Revision	A.05.00

Waveform Sequences

Allows access to the waveform sequence sub-menus. Pressing this key changes the central view area to display the Waveform Sequence List view.

Key Path	Source, Modulation Setup, ARB
Notes	No remote command, SCPI front panel only.
Initial S/W Revision	A.05.00

Build New Sequence

Allows access to the sub-menus for creating a new waveform sequence. Pressing this key changes the central view area to display the Waveform Sequence Creation and Editing view.

Key Path	Source, Modulation Setup, ARB, Waveform Sequences
Notes	No remote command, SCPI front panel only.
Initial S/W Revision	A.05.00

Current Segment

Specifies the selected sequence segment that will be affected by the menu functions.

Key Path	Source, Modulation Setup , ARB, Waveform Sequences, Build New Sequence
Notes	No remote command, SCPI front panel only. This key is grayed out and unavailable if the sequence is currently empty.
Initial S/W Revision	A.05.00

Insert New Waveform

Allows you access to the sub-menu for inserting a new waveform segment or sequence. Pressing this key also changes the central display to show the Waveform File Selection View.

Key Path	Source, Modulation Setup, ARB, Waveform Sequences, Build New Sequence
Notes	No remote command, SCPI front panel only. Waveform segment name string length upper limit is 128 chars. Please do NOT insert waveform which name string exceeds 128 chars.
Initial S/W Revision	A.05.00

Insert Waveform

Inserts the currently highlighted waveform to the end of the waveform sequence. Pressing this key also returns you to the menus for creating or editing a sequence, and returns the central view to the sequence creation view.

Key Path	Source, Modulation Setup, ARB, Waveform Sequences, Build New Sequence, Insert New Waveform
Notes	No remote command, SCPI front panel only. Waveform segment name string length upper limit is 128 chars. Please do NOT insert waveform which name string exceeds 128 chars.
Initial S/W Revision	A.05.00

Segments on Hard Disk

Allows you access to the sub-menus for loading waveform segments from the hard disk into ARB memory. The default directory is: D: varb.

Pressing this key changes the current view to the Waveform Management View.

Key Path	Source, Modulation Setup, ARB, Select Waveform
Initial S/W Revision	A.05.00

Load Segment To ARB Memory

Allows you to load the selected file into ARB memory. On the front panel you select the file for loading to the ARB memory by highlighting the desired file in the list. Using the SCPI command, you specify the file name on the HDD.

“NVWFM” (none-volatile storage) MSUS (Mass Storage Unit Specifier) is supported in the memory subsystem because the ARB memory cannot be accessed directly. Therefore, files must be downloaded to the instrument hard disk and then loaded into the ARB memory. “NVWFM” MSUS will be mapped to the default directory D: VARB. The SCPI command supports using either “NVWFM” MSUS or specifying a full path. For more information, see Memory Subsystem (Remote Command Only).

If a file of the same name already exists within ARB memory, it is overwritten. If you wish to load two segments of the same name, you must rename one of the segments before loading it into ARB memory. To rename a segment, you can either use Windows File Explorer, or the :MMEMory:COPI command.

NOTE: When a waveform file is loaded to ARB memory, burst timing adjustments are made automatically, based on whether or not a Multiport Adapter is connected to the test set and powered on. If the connection/power status of the Multiport Adapter is changed after a waveform file has been loaded, it needs to be loaded again.

Key Path	Source, Modulation Setup, ARB, Select Waveform, Segments on Hard Disk
Remote Command	:SOURce:RADio:ARB:LOAD <string>
Example	:SOUR:RAD:ARB:LOAD "D: VARB\testwaveform.bin" or :SOUR:RAD:ARB:LOAD "NVWFM:testwaveform.bin"
Notes	<p>Because loading the file involves a delay of unpredictable length, this command should be followed by the query *OPC?, which holds off subsequent commands until the loading operating is complete.</p> <p><string> – specifies the path name of the file to load from the HDD into ARB memory. It could be a <full path + filename>, or <“NVWFM” MSUS + colon + filename>.</p> <p>When in Sequence Analyzer mode, and Include Source is Yes, an attempt to load a file to ARB memory will be rejected with an error.</p> <p>When Include Source is No and if there is insufficient free ARB memory to load the selected waveform, an error is generated. .</p> <p>If you specify a file over SCPI, but the file is not at the specified location, an error is generated.</p> <p>If you try to load a waveform file but the file contains less than 500 IQ samples, an error is generated.</p> <p>If you try to load a Signal Studio waveform “*.wfm” which contains invalid waveform header, an error is generated.</p>

If the ARB is ON when you load a file to ARB memory or delete a file from ARB memory, the playing waveform segment may not keep phase continuity during the ARB memory operation. The waveform will be replayed after the ARB operation is finished.

ARB can be loaded into ARB memory even if required licenses do not present on the instrument. In this case, a GUI only warning message -800, "Operation complete; Loaded <filename> successfully, but no license <required licenses> installed". User can install required licenses according to <required licenses> string to license it, or multi-pack license it.

Initial S/W Revision	A.05.00
----------------------	---------

Load All To ARB Memory

Allows you to load all the segment files within the currently selected directory into ARB memory. If a file of the same name already exists within ARB memory, it is overwritten. If you wish to load two segments of the same name, you must rename one of the segments before loading it into ARB memory. To rename a segment, you can either use Windows File Explorer, or the :MEMory:COpy command.

NOTE: When a waveform file is loaded to ARB memory, burst timing adjustments are made automatically, based on whether or not a Multiport Adapter is connected to the test set and powered on. If the connection/power status of the Multiport Adapter is changed after a waveform file has been loaded, it needs to be loaded again.

Key Path	Source, Modulation Setup, ARB, Select Waveform, Segments on Hard Disk
----------	---

Remote Command	:SOURce:RADio:ARB:LOAD:ALL <string>
----------------	-------------------------------------

Example	:SOUR:RAD:ARB:LOAD:ALL "D: varb"
---------	----------------------------------

Notes	<p><string> - specifies the directory on the HDD to load the files into ARB memory from.</p> <p>When in Sequence Analyzer mode, and Include Source is Yes, an attempt to load all files from a directory to ARB memory is rejected with an error.</p> <p>When Include Source is No and there is insufficient free ARB memory to load all the waveforms, when the ARB memory is full, the copy ceases, and an error is generated.</p> <p>If you specify a directory over SCPI, but the directory does not exist, an error is generated.</p> <p>If the ARB is ON, a user then loads or deletes file to ARB memory, the playing waveform segment may not keep phase continuity during the ARB memory operation. The waveform will be replayed after the ARB operation is finished.</p>
-------	---

Initial S/W Revision	A.05.00
----------------------	---------

Change Directory...

Allows you to change the currently selected directory on the hard disk. Pressing this key opens a standard windows change directory dialog allowing you to select the new directory of interest.

The current directory is used for manually loading waveform segments into ARB memory for playback, and as a search location for waveform segments that are required to be loaded into ARB memory for playback of a waveform sequence or a list sequence.

Key Path	Source, Modulation Setup, ARB, Select Waveform, Segments on Hard Disk
Notes	No remote command, SCPI front panel only.
Initial S/W Revision	A.05.00

Default Directory...

Allows you to change the default directory. It is used as a search location for waveform segments that are required to be loaded into ARB memory for playback of a waveform sequence, and as a search location for selecting waveforms using SCPI.

Key Path	Source, Modulation Setup, ARB, Select Waveform, Segments on Hard Disk
Remote Command	:SOURce:RADio:ARB:DEFault:DIRectory <string> :SOURce:RADio:ARB: DEFault:DIRectory?
Example	:SOUR:RAD:ARB:DEF:DIR "D:\ArbFiles" :SOUR:RAD:ARB:DEF:DIR?
State Saved	Persistent, survives a power cycle and a preset but not saved in the instrument state
Initial S/W Revision	A.05.00

Segments in ARB Memory

Allows you access to the sub-menus for managing the files within ARB memory.

Key Path	Source, Modulation Setup, ARB, Select Waveform
Initial S/W Revision	A.05.00

Delete Segment From ARB Mem

Allows you to remove a segment from ARB playback memory.

Key Path	Source, Modulation Setup, ARB, Select Waveform, Segments in ARB Memory
Remote Command	:SOURce:RADio:ARB:DELete <string>
Example	:SOUR:RAD:ARB:DEL "testwaveform.bin"
Notes	<string> - specifies the waveform to be deleted from the ARB playback memory. When in Sequence Analyzer mode and Include Source is Yes, an attempt to delete a file from ARB memory is rejected with an error. When Include Source is No and you specify a file that does not exist within ARB memory, an error is generated. It is possible to delete files from within the ARB memory when the ARB is ON. However, if you attempt to delete the file that is currently playing an error is generated. It is possible to delete a file from within the ARB memory when the sequencer state is ON and the file is not being used by the List Sequencer. If you attempt to delete a file which is being used by the list

sequencer, an error is generated.

When sequencer state is On, even if ARB state is On, the selected waveform will not be played. In this case, if the selected waveform is not used in List Sequence, it can be deleted and the ARB state is turned Off.

If the ARB is ON and you load a file to ARB memory or delete a file from ARB memory, the playing waveform segment may not keep phase continuity during the ARB memory operation. The waveform will be replayed after the ARB operation is finished.

Initial S/W Revision A.05.00

Delete All From ARB Memory

Allows you to remove all segments from ARB playback memory.

Key Path Source, Modulation Setup, ARB, Select Waveform, Segments in ARB Memory

Remote Command :SOURce:RADio:ARB:DELeTe:ALL

Example :SOUR:RAD:ARB:DELeTe:ALL

Notes

When in Sequence Analyzer mode and Include Source is Yes, an attempt to delete all files from ARB memory is rejected with an error.

When Include Source is No and you attempt to delete all files from ARB memory when the ARB is currently playing a file, all files except the one playing are deleted and an error is generated.

If you attempt to delete all files from ARB memory when there are waveform files used in "[List Sequencer](#)" on page 2168 and "[Sequencer](#)" on page 2168 state is ON, all files except the files currently being used in list sequencer are deleted, and an error is generated.

If the ARB is ON and you load a file to ARB memory or delete a file from ARB memory, the playing waveform segment may not keep phase continuity during the ARB memory operation. The waveform will be replayed after the ARB operation is finished.

Initial S/W Revision A.05.00

Edit Selected Waveform

Allows access to the sub-menus for editing the details of the currently selected waveform segment.

Key Path Source, Modulation Setup, ARB, Waveform Sequences, Build New Sequence

Notes No remote command, front panel only.

Initial S/W Revision A.05.00

Repetitions

Allows you to specify the number of times the currently selected waveform is played within the sequence.

Key Path Source, Modulation Setup, ARB, Waveform Sequences, Build New Sequence, Edit Selected Waveform

Notes	No remote command, SCPI front panel only.
Preset	1
Min	1
Max	65535
Initial S/W Revision	A.05.00

Marker 1

Allows you to enable or disable marker 1 for the currently selected waveform. For a waveform sequence, you can enable and disable markers on a per-segment basis, allowing you to output markers from some waveform segments within the sequence, but not for others.

Key Path	Source, Modulation Setup, ARB, Waveform Sequences, Build New Sequence, Edit Selected Waveform
Notes	No remote command, front panel only.
Preset	Enabled
Range	Enabled Disabled
Initial S/W Revision	A.05.00

Marker 2

Allows you to enable or disable marker 2 for the currently selected waveform. For a waveform sequence, you can enable and disable markers on a per-segment basis, allowing you to output markers from some waveform segments within the sequence, but not for others.

Key Path	Source, Modulation Setup, ARB, Waveform Sequences, Build New Sequence, Edit Selected Waveform
Notes	No remote command, front panel only.
Preset	Enabled
Range	Enabled Disabled
Initial S/W Revision	A.05.00

Marker 3

Allows you to enable or disable marker 3 for the currently selected waveform. For a waveform sequence, you can enable and disable markers on a per-segment basis, allowing you to output markers from some waveform segments within the sequence, but not for others.

Key Path	Source, Modulation Setup, ARB, Waveform Sequences, Build New Sequence, Edit Selected Waveform
----------	---

Notes	No remote command, front panel only.
Preset	Enabled
Range	Enabled Disabled
Initial S/W Revision	A.05.00

Marker 4

Allows you to enable or disable marker 4 for the currently selected waveform. For a waveform sequence, you can enable and disable markers on a per-segment basis, allowing you to output markers from some waveform segments within the sequence, but not for others.

Key Path	Source, Modulation Setup, ARB, Waveform Sequences, Build New Sequence, Edit Selected Waveform
Notes	No remote command, front panel only.
Preset	Enabled
Range	Enabled Disabled
Initial S/W Revision	A.05.00

Delete Segment

Allows you to delete the selected segment from the waveform sequence.

Key Path	Source, Modulation Setup, ARB, Waveform Sequences, Build New Sequence
Notes	No remote command, front panel only.
Initial S/W Revision	A.05.00

Save Sequence...

Pressing this key displays the “Save As” dialog. The sequence name is passed to the save as dialog to use as the filename for saving, and the directory the save as dialog will open into is the default waveform directory.

Key Path	Source, Modulation Setup, ARB, Waveform Sequences, Build New Sequence
Initial S/W Revision	A.05.00

Edit Selected Sequence

Allows access to the sub-menus for editing the sequence currently selected within the Waveform Sequence List view. Pressing this key changes the central view area to display the Waveform Sequence Creation and Editing view.

Key Path	Source, Modulation Setup, ARB, Waveform Sequences
Notes	No remote command, front panel only.
Initial S/W Revision	A.05.00

Current Directory...

Allows you to change the currently selected directory on the hard disk. Pressing this key opens a standard windows change directory dialog and allows you to select the new directory of interest.

Key Path	Source, Modulation Setup, ARB, Waveform Sequences
Notes	No remote command, front panel only.
Initial S/W Revision	A.05.00

Waveform Utilities

Allows you access to the waveform utilities sub-menus.

Key Path	Source, Modulation Setup, ARB
Initial S/W Revision	A.05.00

Multi-Pack Licenses

Allows you access to the Multi - Pack License sub-menus. Pressing this key also changes the central view area to display the Multi -Pack License Management view.

On modular instrument like E6630A or E6640A, multi-pack license operations are only allowed on the default module, i.e. “Left” module for E6630A or “TRX1” module for E6640A.

Key Path	Source, Modulation Setup, ARB, Waveform Utilities
Dependencies	This key is only available if there is at least one Multi-pack license installed on the instrument.
Initial S/W Revision	A.05.00

Add Waveform

Pressing this key accesses the Add Waveform sub-menu. It also changes the central display area to display the Multi-Pack License Waveform Add view.

Key Path	Source, Modulation Setup, ARB, Waveform Utilities, Multi-Pack Licenses
Dependencies	This key is only available if there is at least one slot available within at least one multi-pack license.
Initial S/W Revision	A.05.00

Add Waveform

Allows you to add the currently selected waveform segment to a multi-pack license. The new waveform is added to the next available slot regardless of which slot was selected on the Multi-Pack License Management view.

Key Path	Source, Modulation Setup, ARB, Waveform Utilities, Multi-Pack Licenses, Add Waveform
Remote Command	:SYSTem:LKEY:WAVeform:ADD <string> or :SYSTem:LICense[:FPACK]:WAVeform:ADD <string>
Example	SYST:LKEY:WAV:ADD "mywaveform.wfm" or SYST:LIC:WAV:ADD "mywaveform.wfm"
Notes	The second SCPI :SYSTem:LICense[:FPACK]:WAVeform:ADD is provided to be consistent with the style of Keysight signal sources. You can use either one of them. Since adding a waveform segment to a Multi-Pack license causes the license slot to enter the trial period of only 48 hours, pressing this key causes a confirmation dialog to be displayed to ensure you do want to add the waveform segment to the Multi-Pack. If you attempt to license a waveform that is already licensed using another slot an error is generated. .
Dependencies	This key is only available if the currently selected file is a secure waveform requiring a license, and there is at least one slot available within at least one multi-pack license. If the waveform highlighted is a secure waveform, but is already licensed, this key will be unavailable.
Initial S/W Revision	A.05.00

Segments on Hard Disk

Allows you access to the sub-menus for loading waveform segments from the hard disk into ARB memory. The default directory is: D: varb.

Pressing this key changes the current view to the Waveform Management View.

Key Path	Source, Modulation Setup, ARB, Select Waveform
Initial S/W Revision	A.05.00

Load Segment To ARB Memory

Allows you to load the selected file into ARB memory. On the front panel you select the file for loading to the ARB memory by highlighting the desired file in the list. Using the SCPI command, you specify the file name on the HDD.

"NVWFM" (none-volatile storage) MSUS (Mass Storage Unit Specifier) is supported in the memory subsystem because the ARB memory cannot be accessed directly. Therefore, files must be downloaded to the instrument hard disk and then loaded into the ARB memory. "NVWFM" MSUS will be mapped to the

default directory D: VARB. The SCPI command supports using either “NVWFM” MSUS or specifying a full path. For more information, see Memory Subsystem (Remote Command Only).

If a file of the same name already exists within ARB memory, it is overwritten. If you wish to load two segments of the same name, you must rename one of the segments before loading it into ARB memory. To rename a segment, you can either use Windows File Explorer, or the :MMEMory:COPI command.

NOTE: When a waveform file is loaded to ARB memory, burst timing adjustments are made automatically, based on whether or not a Multiport Adapter is connected to the test set and powered on. If the connection/power status of the Multiport Adapter is changed after a waveform file has been loaded, it needs to be loaded again.

Key Path	Source, Modulation Setup, ARB, Select Waveform, Segments on Hard Disk
Remote Command	:SOURce:RADio:ARB:LOAD <string>
Example	:SOUR:RAD:ARB:LOAD “D: VARB\testwaveform.bin” or :SOUR:RAD:ARB:LOAD “NVWFM:testwaveform.bin”
Notes	<p>Because loading the file involves a delay of unpredictable length, this command should be followed by the query *OPC?, which holds off subsequent commands until the loading operating is complete.</p> <p><string> – specifies the path name of the file to load from the HDD into ARB memory. It could be a <full path + filename>, or <“NVWFM” MSUS + colon + filename>.</p> <p>When in Sequence Analyzer mode, and Include Source is Yes, an attempt to load a file to ARB memory will be rejected with an error.</p> <p>When Include Source is Noand if there is insufficient free ARB memory to load the selected waveform, an error is generated. .</p> <p>If you specify a file over SCPI, but the file is not at the specified location, an error is generated.</p> <p>If you try to load a waveform file but the file contains less than 500 IQ sampes, an error is generated.</p> <p>If you try to load a Signal Studio waveform “*.wfm” which contains invalid waveform header, an error is generated.</p> <p>If the ARB is ON when you load afile to ARB memory or delete a file from ARB memory, the playing waveform segment may not keep phase continuity during the ARB memory operation. The waveform will be replayed after the ARB operation is finished.</p> <p>ARB can be loaded into ARB memory even required licenses do not present on the instrument. In this case, a GUI only warning message -800, “Operation complete; Loaded <filename> successfully, but no license <required licenses> installed”. User can install required licenses according to <required licenses> string to license it, or multi-pack license it.</p>
Initial S/W Revision	A.05.00

Load All To ARB Memory

Allows you to load all the segment files within the currently selected directory into ARB memory. If a file of the same name already exists within ARB memory, it is overwritten. If you wish to load two segments of the same name, you must rename one of the segments before loading it into ARB memory. To rename a segment, you can either use Windows File Explorer, or the :MEMory:COPI command.

NOTE: When a waveform file is loaded to ARB memory, burst timing adjustments are made automatically, based on whether or not a Multiport Adapter is connected to the test set and powered on. If the

connection/power status of the Multiport Adapter is changed after a waveform file has been loaded, it needs to be loaded again.

Key Path	Source, Modulation Setup, ARB, Select Waveform, Segments on Hard Disk
Remote Command	:SOURce:RADio:ARB:LOAD:ALL <string>
Example	:SOUR:RAD:ARB:LOAD:ALL "D: varb"
Notes	<p><string> - specifies the directory on the HDD to load the files into ARB memory from.</p> <p>When in Sequence Analyzer mode, and Include Source is Yes, an attempt to load all files from a directory to ARB memory is rejected with an error.</p> <p>When Include Source is No and there is insufficient free ARB memory to load all the waveforms, when the ARB memory is full, the copy ceases, and an error is generated.</p> <p>If you specify a directory over SCPI, but the directory does not exist, an error is generated.</p> <p>If the ARB is ON, a user then loads or deletes file to ARB memory, the playing waveform segment may not keep phase continuity during the ARB memory operation. The waveform will be replayed after the ARB operation is finished.</p>
Initial S/W Revision	A.05.00

Change Directory...

Allows you to change the currently selected directory on the hard disk. Pressing this key opens a standard windows change directory dialog allowing you to select the new directory of interest.

The current directory is used for manually loading waveform segments into ARB memory for playback, and as a search location for waveform segments that are required to be loaded into ARB memory for playback of a waveform sequence or a list sequence.

Key Path	Source, Modulation Setup, ARB, Select Waveform, Segments on Hard Disk
Notes	No remote command, SCPIfront panel only.
Initial S/W Revision	A.05.00

Default Directory...

Allows you to change the default directory. It is used as a search location for waveform segments that are required to be loaded into ARB memory for playback of a waveform sequence, and as a search location for selecting waveforms using SCPI.

Key Path	Source, Modulation Setup, ARB, Select Waveform, Segments on Hard Disk
Remote Command	:SOURce:RADio:ARB:DEFault:DIRectory <string> :SOURce:RADio:ARB: DEFault:DIRectory?
Example	:SOUR:RAD:ARB:DEF:DIR "D:\ArbFiles" :SOUR:RAD:ARB:DEF:DIR?
State Saved	Persistent, survives a power cycle and a preset but not saved in the instrument state
Initial S/W Revision	A.05.00

Replace Waveform

Pressing this key accesses the Replace Waveform submenu. It also changes the central display area to display the Multi-Pack License Waveform Add view.

Key Path	Source, Modulation Setup, ARB, Waveform Utilities, Multi-Pack Licenses
Dependencies	This key is only available if the currently selected slot is in the trial state.
Initial S/W Revision	A.05.00

Replace Waveform

Allows you to replace the waveform in the currently selected slot with the waveform currently selected in the Multi-Pack License Waveform Add view.

Key Path	Source, Modulation Setup, ARB, Waveform Utilities, Multi-Pack Licenses, Replace Waveform
Remote Command	:SYSTem:LKEY:WAVeform:REPLace <int>, <string> or :SYSTem:LIcense[:FPACK]:WAVeform:REPLace <int>, <string>
Example	SYST:LKEY:WAV:REPL 1, "myotherwaveform.wfm" or :SYST:LIC:WAV:REPL 1, "myotherwaveform.wfm"
Notes	The second SCPI :SYSTem:LIcense[:FPACK]:WAVeform:REPLace is provided to be consistent with the style of Keysight signal sources. You can use either one of them. If you attempt to license a waveform that is already licensed using another slot an error is generated. Waveform slot number <int> is positive. If you attempt to input a slot number less than or equals 0, an error is generated.
Initial S/W Revision	A.05.00

Clear Waveform from Slot

Allows you to clear the waveform from the selected slot.

Key Path	Source, Modulation Setup, ARB, Waveform Utilities, Multi-Pack Licenses
Remote Command	:SYSTem:LKEY:WAVeform:CLEar <int> or :SYSTem:LIcense[:FPACK]:WAVeform:CLEar <int>
Example	SYST:LKEY:WAV:CLE 1 or :SYST:LIC:WAV:CLE 1
Notes	The second SCPI :SYSTem:LIcense[:FPACK]:WAVeform:CLEar is provided to be consistent with the style of Keysight signal sources. You can use either one of them. Waveform slot number <int> is positive. If you attempt to input a slot number less than or equals 0, an

error is generated.

Dependencies	This key is only available if the currently selected slot is in the trial state.
Initial S/W Revision	A.05.00

Lock Waveform in Slot

If the selected slot is in the trial state or the lock required state, the waveform that occupies the slot is locked and permanently licensed.

Key Path	Source, Modulation Setup, ARB, Waveform Utilities, Multi-Pack Licenses
----------	--

Remote Command	:SYSTem:LKEY:WAVeform:LOCK <int> or :SYSTem:LICense[:FPACK]:WAVeform:LOCK <int>
----------------	---

Example	SYST:LKEY:WAV:LOCK 1 or SYST:LIC:WAV:LOCK 1
---------	---

Notes	The second SCPI :SYSTem:LICense[:FPACK]:WAVeform:LOCK is provided to be consistent with the style of Keysight signal sources. You can use either one of them. Waveform slot number <int> is positive. If you attempt to input a slot number less than or equals 0, an error is generated.
-------	--

Dependencies	This key is only available if the currently selected slot is in the trial state or the lock required state.
Initial S/W Revision	A.05.00

Marker Utilities

Allows access to the marker utilities sub-menus.

Key Path	Source, Modulation Setup, ARB
Initial S/W Revision	A.05.00

Marker Polarity

Allows access to the marker polarity sub-menu, which allows you to specify the polarity for the four markers. For a positive polarity, the marker signal is high during the marker points. For a negative marker polarity, the marker signal is high during the period of no marker points.

Key Path	Source, Modulation Setup, ARB, Marker Utilities
Initial S/W Revision	A.05.00

Mkr 1 Polarity

Allows you to set the polarity of marker 1.

Key Path	Source, Modulation Setup, ARB, Marker Utilities, Marker Polarity
Remote Command	:SOURce:RADio:ARB:MPOLarity:MARKer1 POSitive NEGative :SOURce:RADio:ARB:MPOLarity:MARKer1?
Example	:SOUR:RAD:ARB:MPOL:MARK1 NEG
Dependencies	When a new waveform is selected for playback the settings contained within the associated waveform header file are applied to the ARB. The marker polarity is one of the values stored within the header file. If the newly selected waveform file has an associated header file, the marker polarity is updated with the value from the header file. The marker polarity will remain unchanged if the newly selected waveform does not have an associated header file.
Preset	Pos
Range	Neg Pos
Initial S/W Revision	A.05.00

Mkr 2 Polarity

Allows you to set the polarity of marker 2.

Key Path	Source, Modulation Setup, ARB, Marker Utilities, Marker Polarity
Remote Command	:SOURce:RADio:ARB:MPOLarity:MARKer2 POSitive NEGative :SOURce:RADio:ARB:MPOLarity:MARKer2?
Example	:SOUR:RAD:ARB:MPOL:MARK2 NEG
Dependencies	When a new waveform is selected for playback the settings contained within the associated waveform header file are applied to the ARB. The marker polarity is one of the values stored within the header file. If the newly selected waveform file has an associated header file, the marker polarity is updated with the value from the header file. The marker polarity will remain unchanged if the newly selected waveform does not have an associated header file.
Preset	Pos
Range	Neg Pos
Initial S/W Revision	A.05.00

Mkr 3 Polarity

Allows you to set the polarity of marker 3.

Key Path	Source, Modulation Setup, ARB, Marker Utilities, Marker Polarity
Remote Command	:SOURce:RADio:ARB:MPOLarity:MARKer3 POSitive NEGative :SOURce:RADio:ARB:MPOLarity:MARKer3?
Example	:SOUR:RAD:ARB:MPOL:MARK3 NEG
Dependencies	When a new waveform is selected for playback the settings contained within the associated

	waveform header file are applied to the ARB. The marker polarity is one of the values stored within the header file. If the newly selected waveform file has an associated header file, the marker polarity is updated with the value from the header file. The marker polarity will remain unchanged if the newly selected waveform does not have an associated header file.
Preset	Pos
Range	Neg Pos
Initial S/W Revision	A.05.00

Mkr 4 Polarity

Allows you to set the polarity of marker 4.

Key Path	Source, Modulation Setup, ARB, Marker Utilities, Marker Polarity
Remote Command	:SOURce:RADio:ARB:MPOLarity:MARKer4 POSitive NEGative :SOURce:RADio:ARB:MPOLarity:MARKer4?
Example	:SOUR:RAD:ARB:MPOL:MARK4 NEG
Dependencies	When a new waveform is selected for playback the settings contained within the associated waveform header file are applied to the ARB. The marker polarity is one of the values stored within the header file. If the newly selected waveform file has an associated header file, the marker polarity is updated with the value from the header file. The marker polarity will remain unchanged if the newly selected waveform does not have an associated header file.
Preset	Pos
Range	Neg Pos
Initial S/W Revision	A.05.00

Marker Routing

Allows access to the marker routing sub-menus, which allow you to specify where the marker events are routed. It should be noted that the markers can also be routed to Trigger 1 Out and Trigger 2 Out, however this must be set up using the menus accessed by pressing the “Trigger” hard key.

Key Path	Source, Modulation Setup, ARB, Marker Utilities
Initial S/W Revision	A.05.00

Pulse/RF Blank

Allows you to select which marker is used for the pulse/RF blanking function. The pulse/RF blanking function blanks the RF when the marker signal goes low. The marker polarity determines when the marker signal is high. For a positive polarity, this is during the marker points. For a negative polarity, this is when there are no marker points.

Marker points should be set before using this function. Enabling this function without setting marker points may create a continuous low or high signal, dependant on the marker polarity. This causes either no RF output, or a continuous RF output.

Key Path	Source, Modulation Setup, ARB, Marker Utilities, Marker Routing
Remote Command	:SOURce:RADio:ARB:MDESTination:PULSe NONE M1 M2 M3 M4 :SOURce:RADio:ARB:MDESTination:PULSe?
Example	:SOUR:RAD:ARB:MDES:PULS NONE
Dependencies	When a new waveform is selected for playback the settings contained within the associated waveform header file are applied to the ARB. The pulse/RF blanking setting is one of the values stored within the header file. If the newly selected waveform file has an associated header file, the pulse/RF blanking setting is updated with the value from the header file. The pulse/RF blanking setting will remain unchanged if the newly selected waveform does not have an associated header file.
Range	None M1 M2 M3 M4
Initial S/W Revision	A.05.00

None

Sets no marker to be used for the pulse/RF blanking function, essentially turning the RF blanking function off.

Key Path	Source, Modulation Setup, ARB, Marker Utilities, Marker Routing, Pulse/RF Blank
Example	:SOUR:RAD:ARB:MDES:PULS NONE
Initial S/W Revision	A.05.00

Marker 1

Sets marker 1 to be used for the pulse/RF blanking function.

Key Path	Source, Modulation Setup, ARB, Marker Utilities, Marker Routing, Pulse/RF Blank
Example	:SOUR:RAD:ARB:MDES:PULS M1
Initial S/W Revision	A.05.00

Marker 2

Sets marker 2 to be used for the pulse/RF blanking function.

Key Path	Source, Modulation Setup, ARB, Marker Utilities, Marker Routing, Pulse/RF Blank
Example	:SOUR:RAD:ARB:MDES:PULS M2
Initial S/W Revision	A.05.00

Marker 3

Sets marker 3 to be used for the pulse/RF blanking function.

Key Path	Source, Modulation Setup, ARB, Marker Utilities, Marker Routing, Pulse/RF Blank
Example	:SOUR:RAD:ARB:MDES:PULS M3
Initial S/W Revision	A.05.00

Marker 4

Sets marker 4 to be used for the pulse/RF blanking function.

Key Path	Source, Modulation Setup, ARB, Marker Utilities, Marker Routing, Pulse/RF Blank
Example	:SOUR:RAD:ARB:MDES:PULS M4
Initial S/W Revision	A.05.00

ALC Hold

Allows you to specify which marker is routed for use within the ALC hold function. The ALC hold marker function holds the ALC circuitry at the average value of the sample points set by the marker.

The ALC hold function operates during the low periods of the marker signal. The marker polarity determines when the marker signal is high. For positive polarity, this is during the marker points. For a negative polarity, this is when there are no marker points.

Key Path	Source, Modulation Setup, ARB, Marker Utilities, Marker Routing
Remote Command	:SOURce:RADio:ARB:MDEStination:ALCHold NONE M1 M2 M3 M4 :SOURce:RADio:ARB:MDEStination:ALCHold?
Example	:SOUR:RAD:ARB:MDES:ALCH NONE
Dependencies	When a new waveform is selected for playback the settings contained within the associated waveform header file are applied to the ARB. The ALC hold setting is one of the values stored within the header file. If the newly selected waveform file has an associated header file, the ALC hold setting is updated with the value from the header file. The ALC hold setting will remain unchanged if the newly selected waveform does not have an associated header file.
Range	None M1 M2 M3 M4
Initial S/W Revision	A.05.00

None

Sets no marker to be used for the ALC hold function, essentially turning the ALC hold function off.

Key Path	Source, Modulation Setup, ARB, Marker Utilities, Marker Routing, ALC Hold
Example	:SOUR:RAD:ARB:MDES:PULS NONE
Initial S/W Revision	A.05.00

Marker 1

Sets marker 1 to be used for the ALC hold function.

Key Path	Source, Modulation Setup, ARB, Marker Utilities, Marker Routing, ALC Hold
Example	:SOUR:RAD:ARB:MDES:PULS M1
Initial S/W Revision	A.05.00

Marker 2

Sets marker 2 to be used for the ALC hold function.

Key Path	Source, Modulation Setup, ARB, Marker Utilities, Marker Routing, ALC Hold
Example	:SOUR:RAD:ARB:MDES:PULS M2
Initial S/W Revision	A.05.00

Marker 3

Sets marker 3 to be used for the ALC hold function.

Key Path	Source, Modulation Setup, ARB, Marker Utilities, Marker Routing, ALC Hold
Example	:SOUR:RAD:ARB:MDES:PULS M3
Initial S/W Revision	A.05.00

Marker 4

Sets marker 4 to be used for the ALC hold function.

Key Path	Source, Modulation Setup, ARB, Marker Utilities, Marker Routing, ALC Hold
Example	:SOUR:RAD:ARB:MDES:PULS M4
Initial S/W Revision	A.05.00

Header Utilities

Allows access to the header utilities sub-menu. Pressing this key also causes the central display area to change to display the File Header Information view.

Key Path	Source, Modulation Setup, ARB
Dependencies	This key is only available if there is currently a waveform selected for playback. If no waveform is selected, the key is grayed out.
Initial S/W Revision	A.05.00

Clear Header

Allows you to clear the header information from the file header associated with the currently selected waveform.

Key Path	Source, Modulation Setup, ARB, Header Utilities
Remote Command	:SOURce:RADio:ARB:HEADer:CLEar
Example	:SOUR:RAD:ARB:HEAD:CLE
Notes	Attempting to clear the header details via SCPI when no waveform was selected for playback will generate an error.
Initial S/W Revision	A.05.00

Save Setup To Header

Allows you to save new file header information details to the file.

Key Path	Source, Modulation Setup, ARB, Header Utilities
Remote Command	:SOURce:RADio:ARB:HEADer:SAVE
Example	:SOUR:RAD:ARB:HEAD:SAVE
Notes	Attempting to save the header details via SCPI when no waveform was selected for playback will generate an error.
Initial S/W Revision	A.05.00

AM

Allows access to the menu for configuring the Amplitude Modulation.

Key Path	Source, Modulation Setup
Initial S/W Revision	A.05.00

AM

Enables or disables the amplitude modulation.

Turning AM on when another modulation format is already on results in the previous modulation format being turned off and the generation of an error.

Key Path	Source, Modulation Setup, AM
Remote Command	:SOURce:AM:STATe :SOURce:AM:STATe?
Example	:SOUR:AM:STAT OFF

Preset	Off
Range	On Off
Initial S/W Revision	A.05.00

AM Depth

Allows you to set the amplitude modulation depth in percent.

Key Path	Source, Modulation Setup, AM
Remote Command	:SOURce:AM[:DEPTh] [:LINear] :SOURce:AM[:DEPTh] [:LINear]?
Example	:SOUR:AM 0.1
Preset	0.1 %
Min	0.1 %
Max	95.0 %
Initial S/W Revision	A.05.00

AM Rate

Allows you to set the internal amplitude modulation rate.

Key Path	Source, Modulation Setup, AM
Remote Command	:SOURce:AM:INTernal:FREQuency :SOURce:AM:INTernal:FREQuency?
Example	:SOUR:AM:INT:FREQ 40.0 Hz
Preset	400.0 Hz
Min	10 Hz
Max	40 kHz
Initial S/W Revision	A.05.00

FM

Allows access to the menu for configuring the frequency modulation.

Key Path	Source, Modulation Setup
Initial S/W Revision	A.05.00

FM

Enables or disables the frequency modulation.

Turning FM on when another modulation format is already on results in the previous modulation format being turned off and the generation of an error.

Key Path	Source, Modulation Setup, FM
Remote Command	:SOURce:FM:STATe :SOURce:FM:STATe?
Example	:SOUR:FM:STAT OFF
Preset	Off
Range	On Off
Initial S/W Revision	A.05.00

FM Deviation

Allows you to set the frequency modulation deviation.

Key Path	Source, Modulation Setup, FM
Remote Command	:SOURce:FM[:DEVIation] :SOURce:FM[:DEVIation]?
Example	:SOUR:FM 1.00 kHz
Preset	1.00 Hz
Min	1.00 Hz
Max	100.00 kHz
Initial S/W Revision	A.05.00

FM Rate

Allows you to set the internal frequency modulation rate.

Key Path	Source, Modulation Setup, FM
Remote Command	:SOURce:FM:INTernal:FREQuency :SOURce:FM:INTernal:FREQuency?
Example	:SOUR:FM:INT:FREQ 40.0 Hz
Preset	400.0 Hz
Min	10 Hz
Max	40 kHz
Initial S/W Revision	A.05.00

PM

Allows access to the menu for configuring the phase modulation.

Key Path	Source, Modulation Setup
Initial S/W Revision	A.05.00

PM

Enables or disables the phase modulation.

Turning PM on when another modulation format is already on results in the previous modulation format being turned off and the generation of an error.

Key Path	Source, Modulation Setup, PM
Remote Command	:SOURce:PM:STATe :SOURce:PM:STATe?
Example	:SOUR:PM:STAT OFF
Preset	Off
Range	On Off
Initial S/W Revision	A.05.00

PM Deviation

Allows you to set the phase modulation deviation.

Key Path	Source, Modulation Setup, PM
Remote Command	:SOURce:PM[:DEViation] :SOURce:PM[:DEViation]?
Example	:SOUR:PM 1.00 rad
Preset	0.1 rad
Min	0.1 rad
Max	20.0 rad
Initial S/W Revision	A.05.00

PM Rate

Allows you to set the internal phase modulation rate.

Key Path	Source, Modulation Setup, PM
Remote Command	:SOURce:PM:INTernal:FREQuency :SOURce:PM:INTernal:FREQuency?

Example	:SOUR:PM:INT:FREQ 40.0 Hz
Preset	400.0 Hz
Min	10 Hz
Max	40 kHz
Initial S/W Revision	A.05.00

List Sequencer

Allows you access to the sub-menus for configuring the list sequencer.

List sequences allows you to enter frequencies and amplitudes at unequal intervals in nonlinear ascending, descending or random order. Each step within the list can also include its own waveform file for playback, step duration, trigger event and trigger output.

The complexities involved in configuring the list sequencer do not lend itself to manual configuration; hence the manual configuration for this feature is limited. For easier configuration of the list sequencer, it is recommended that you use either SCPI or load a tab delimited file containing the setup parameters in a tabular form. The details of the SCPI for configuring the list sequencer can be found in Step Configuration (Remote Command Only).

Once the List Sequencer has been configured using the front panel, SCPI, or loading in a tab delimited file, the sequence must be initiated using the front panel Initiate Sequence key or the corresponding SCPI command.

Key Path	Source
Initial S/W Revision	A.05.00

Sequencer

Allows you to set the state of the list sequencer. When the list sequencer is on, the source is outputting the sequence defined by the sequencer. When the list sequencer is off, the source outputs a single waveform segment or sequence (independent mode) at a single frequency and amplitude.

Key Path	Source, List Sequencer
Remote Command	:SOURce:LIST[:STATe] ON OFF 1 0 :SOURce:LIST[:STATe]?
Example	:SOUR:LIST OFF
Notes	When the sequencer is set to ON, the list sequencer controls the output of the source.
Couplings	When in Sequence Analyzer mode and the list sequencer state is Off, Include Source is forced to No, and the Include Source key is grayed out. When in Sequence Analyzer mode and the list sequencer state is On, Include Source is available to set. And, an ARB memory related operation, like load or delete will be rejected.

Preset	Off
Range	On Off
Initial S/W Revision	A.05.00

Initiate Sequence

Pressing this key arms the sequence for single execution. Once the sequence is armed the source begins the sequence as soon as the trigger is received. If the trigger is set to Free Run, the sequence starts immediately.

Key Path	Source, List Sequencer
Remote Command	:SOURce:LIST:TRIGger[:IMMediate]
Example	:SOUR:LIST:TRIG
Notes	<p>When in Sequence Analyzer mode and Include Source is Yes, the Initiate list sequencer operation is rejected, and the key is grayed out, since source list sequence request is sent to physics via Parallel batch by sequence analyzer.</p> <p>If the file needed by the sequencer is not already in ARB memory, the sequence cannot be initiated and an error will be generated.</p> <p>There is a blocking SCPI query which can be used to query if source list sequence being initiated successfully or not. (see Query List Sequence Initiation Armed Status (Remote Command Only) Query Source List Sequence Armed Status)</p>
Dependencies	Under the Sequence Analyzer Mode, if Meas Setup->Include Source is set to YES, Source->List Sequencer->Initiate Sequence is disabled.
Initial S/W Revision	A.05.00

List Sequencer Setup

Allows you access to the list sequencer setup menus.

Key Path	Source, List Sequencer
----------	------------------------

Number of Steps

Allows you to specify the number of steps within the list sequence.

Key Path	Source, List Sequencer, List Sequencer Setup
Remote Command	:SOURce:LIST:NUMBer:STEPs <integer> :SOURce:LIST:NUMBer:STEPs?
Example	:SOUR:LIST:NUMB:STEP 1
Notes	Increasing the number of steps creates additional steps at the end of the list, with all the settings

	within the steps set to their default values. Decreasing the number of steps removes steps from the end of the list. The settings within the removed steps are not reset. This means that increasing the number of steps again would allow you to retrieve these steps.
Dependencies	The Step Count parameter is increased or decreased when you insert or delete a point from within the GUI interface to the sequencer.
Preset	1
Min	1
Max	1000
Initial S/W Revision	A.05.00

Current Step

Allows you to select the step number you wish to view or edit.

Key Path	Source, List Sequencer, List Sequencer Setup
Notes	No remote command, front panel only.
Preset	1
Min	1
Max	Step Count
Initial S/W Revision	A.05.00

Insert Step Before

Allows you to insert a new step, containing default values, before the currently selected step. Inserting a step will automatically increase the Step Count parameter by 1. If sequence already reaches upper limit of 1000 steps, then insert more step will be rejected and popup error -221, "Setting Conflict; Cannot insert more steps, maximum number of steps reached"

Key Path	Source, List Sequencer, List Sequencer Setup
Notes	No remote command, front panel only. If the list already contains the maximum limit of 1000 steps, no operation will be made after pressing this key.
Initial S/W Revision	A.05.00

Delete Step

Allows you to delete the current step. Deleting a step will automatically decrease the Step Count parameter by 1. If sequence only has one step left, delete step will be rejected and popup error -221, "Setting conflict; Cannot delete current step, minimum number of steps reached"

Key Path	Source, List Sequencer, List Sequencer Setup
Notes	No remote command, Front Panel key only. If the list already contains the minimum limit of 1 step, no operation will be made after pressing this key
Initial S/W Revision	A.05.00

Clear List

Allows you to clear the list. Clearing the list sets the number of steps to the default value of 1 and sets the parameters for the only step to their default values.

Key Path	Source, List Sequencer, List Sequencer Setup
Initial S/W Revision	A.05.00

Step Trigger

Allows access to the sub-menu for selecting the trigger input for the current step.

Key Path	Source, List Sequencer, List Sequencer Setup
Remote Command	:SOURce:LIST:STEP[1] 2 3...1000:SETup:INPut:TRIGger IMMEDIATE INTERNAL EXTERNAL2 KEY BUS EXTERNAL4 :SOURce:LIST:STEP[1] 2 3...1000:SETup:INPut:TRIGger?
Example	:SOUR:LIST:STEP2:SET:INP:TRIG BUS :SOUR:LIST:STEP2:SET:INP:TRIG?
Notes	SCPI is supported after A.09.40
Preset	Free Run
Range	Free Run Internal Manual (Trigger Key) Bus External 2 EXTERNAL4
Initial S/W Revision	A.05.00

Free Run

Sets the trigger input for the current step to Free Run.

Key Path	Source, List Sequencer, List Sequencer Setup, Step Trigger
Example	:SOUR:LIST:STEP2:SET:INP:TRIG IMM
Notes	SCPI is supported after A.09.40
Initial S/W Revision	A.05.00

Internal

Sets the trigger input for the current step to Internal.

Key Path	Source, List Sequencer, List Sequencer Setup, Step Trigger
Example	:SOUR:LIST:STEP2:SET:INP:TRIG INT
Notes	SCPI is supported after A.09.40
Initial S/W Revision	A.05.00

Manual (Trigger Key)

Sets the trigger input for the current step to Manual (Trigger Key). Any step in the sequence set to Manual will cause the sequence execution to stop until the manual trigger key is pressed. Sending the Bus Trigger SCPI command will have no effect. At any point in the sequence where the list sequencer is paused waiting for a software trigger, a pop up dialog is displayed until the trigger event occurs.

Key Path	Source, List Sequencer, List Sequencer Setup, Step Trigger
Example	:SOUR:LIST:STEP2:SET:INP:TRIG KEY
Notes	SCPI is supported after A.09.40
Initial S/W Revision	A.05.00

Bus

Sets the trigger input for the current step to Bus. Any step in the sequence set to Bus will cause the sequence execution to stop until the Bus Trigger SCPI command is sent. Pressing the manual trigger key has no effect. At any point in the sequence where the list sequencer is paused waiting for a software trigger, a pop up dialog is displayed until the trigger event occurs.

Key Path	Source, List Sequencer, List Sequencer Setup, Step Trigger
Example	:SOUR:LIST:STEP2:SET:INP:TRIG BUS
Notes	SCPI is supported after A.09.40
Initial S/W Revision	A.05.00

External 2

Sets the trigger input for the current step to External 2.

Key Path	Source, List Sequencer, List Sequencer Setup, Step Trigger
Example	:SOUR:LIST:STEP2:SET:INP:TRIG EXT2
Notes	SCPI is supported after A.09.40
Notes	Note: When on E6640A, trigger 2 is a bi-directional trigger port. So when trigger 2 has been configured as OUTPUT type, choosing External 2 as the input trigger for the current step will generate error.
Initial S/W Revision	A.05.00

Transition Time

Allows you to specify the transition time for the current step.

The transition time is the amount of time allowed for the source to settle at the current frequency or amplitude value.

Transition Time should not be taken as additional time before or inside the Step Duration. You can set a value for the settling time to allow the source output frequency or amplitude to become stable. Make sure that during this period of time, you do not use the source output signal.

The following table lists recommended values for appropriate settling times to allow for changes within the source.

Value Changed	Recommended Transition Time
Frequency	500 μ s
Amplitude	100 μ s to within 0.1 dB 20 μ s to within 1.0 dB

If the Transition Time value is shorter than the time necessary for the hardware to settle and a List Sequence is initiated, a **warning** is generated.

If the Transition Time value is longer than the Step Duration, an error is generated when initiating a source list sequence. For source list sequence, transition time is included in the step duration length. If the Transition Time value is longer than the Step Duration Time, the real step duration length is extended to equal the transition time and cause a timing shift.

Key Path	Source, List Sequencer, List Sequencer Setup
Remote Command	:SOURce:LIST:STEP[1] 2 3...1000:SETup:TRANSition:TIME <time> :SOURce:LIST:STEP[1] 2 3...1000:SETup:TRANSition:TIME?
Example	:SOUR:LIST:STEP2:SET:TRAN:TIME 1ms :SOUR:LIST:STEP2:SET:TRAN:TIME?
Notes	SCPI is supported after A.09.40
Preset	1.0 ms
Min	0.0 ms
Max	4.0 ks
Initial S/W Revision	A.05.00

Radio Setup

Allows you access to the sub-menus for setting up the radio standard, band, and radio band link direction for the current step.

Key Path	Source, List Sequencer, List Sequencer Setup
Notes	No remote command, front panel only.

Initial S/W Revision	A.05.00
----------------------	---------

Radio Standard

Allows access to the sub-menus for selecting the radio standard and the associated radio band for use in the current step.

Key Path	Source, List Sequencer, List Sequencer Setup, Radio Setup
Remote Command	:SOURce:LIST:STEP[1] 2 3...1000:SETup:RADio:BAND NONE PGSM EGSM RGSM DCS1800 PCS1900 TGSM810 GSM450 GSM480 GSM700 GSM850 BANDI BANDII BANDIII BANDIV BANDV BANDVI BANDVII BANDVIII BANDIX BANDX BANDXI BANDXII BANDXIII BANDXIV BANDXIX USCELL USPCS JAPAN KOREAN NMT IMT2K UPPER SECOND PAMR400 PAMR800 IMTEXT PCS1DOT9G AWS US2DOT5G PUBLIC LOWER NONE BAND1 BAND2 BAND3 BAND4 BAND5 BAND6 BAND7 BAND8 BAND10 BAND11 BAND12 BAND13 BAND14 BAND17 BAND18 BAND19 BAND20 BAND21 BAND24 BAND25 BAND26 BAND27 BAND28 BAND29 BAND30 BAND31 BAND33 BAND34 BAND35 BAND36 BAND37 BAND38 BAND39 BAND40 BAND41 BAND42 BAND43 BAND44 BANDA BANDB BANDC BANDD BANDE BANDF :SOURce:LIST:STEP[1] 2 3...1000:SETup: RADio:BAND?
Example	:SOUR:LIST:STEP2:SET:RAD:BAND PGSM :SOUR:LIST:STEP2:SET:RAD:BAND?
Notes	SCPI is supported after A.09.40
Initial S/W Revision	A.05.00

None

Selects no radio standard for use on the current step.

Key Path	Source, List Sequencer, List Sequencer Setup, Radio Setup, Radio Standard
Example	:SOUR:LIST:STEP2:SET:RAD:BAND NONE
Notes	SCPI is supported after A.09.40
Initial S/W Revision	A.05.00

GSM/EDGE

Pressing this key once selects GSM/EDGE as the radio standard and the current GSM/EDGE band as the active channel band. Pressing this key again allows access to the sub-menus for selecting a different GSM/EDGE band.

Key Path	Source, List Sequencer, List Sequencer Setup, Radio Setup, Radio Standard
Initial S/W Revision	A.05.00

P-GSM

Selects P-GSM as the band for the current step.

Key Path	Source, List Sequencer, List Sequencer Setup, Radio Setup, Radio Standard, GSM/EDGE
Initial S/W Revision	A.05.00

E-GSM

Selects E-GSM as the band for the current step.

Key Path	Source, List Sequencer, List Sequencer Setup, Radio Setup, Radio Standard, GSM/EDGE
Initial S/W Revision	A.05.00

R-GSM

Selects R-GSM as the band for the current step.

Key Path	Source, List Sequencer, List Sequencer Setup, Radio Setup, Radio Standard, GSM/EDGE
Initial S/W Revision	A.05.00

DCS 1800

Selects DCS 1800 as the band for the current step.

Key Path	Source, List Sequencer, List Sequencer Setup, Radio Setup, Radio Standard, GSM/EDGE
Initial S/W Revision	A.05.00

PCS 1900

Selects PCS 1900 as the band for the current step.

Key Path	Source, List Sequencer, List Sequencer Setup, Radio Setup, Radio Standard, GSM/EDGE
Initial S/W Revision	A.05.00

GSM 450

Selects GSM 450 as the band for the current step.

Key Path	Source, List Sequencer, List Sequencer Setup, Radio Setup, Radio Standard, GSM/EDGE
Initial S/W Revision	A.05.00

GSM 480

Selects GSM 480 as the band for the current step.

Key Path	Source, List Sequencer, List Sequencer Setup, Radio Setup, Radio Standard, GSM/EDGE
Initial S/W Revision	A.05.00

GSM 850

Selects GSM 850 as the band for the current step.

Key Path	Source, List Sequencer, List Sequencer Setup, Radio Setup, Radio Standard, GSM/EDGE
Initial S/W Revision	A.05.00

GSM 700

Selects GSM 700 as the band for the current step.

Key Path	Source, List Sequencer, List Sequencer Setup, Radio Setup, Radio Standard, GSM/EDGE
Initial S/W Revision	A.05.00

T-GSM 810

Selects T-GSM 810 as the band for the current step.

Key Path	Source, List Sequencer, List Sequencer Setup, Radio Setup, Radio Standard, GSM/EDGE
Initial S/W Revision	A.05.00

WCDMA

Pressing this key once selects WCDMA as the radio standard and the current WCDMA band as the active channel band. Pressing this key again allows access to the sub-menus for selecting a different WCDMA band.

Key Path	Source, List Sequencer, List Sequencer Setup, Radio Setup, Radio Standard
Initial S/W Revision	A.05.00

Band I

Selects Band I as the band for the current step.

Key Path	Source, List Sequencer, List Sequencer Setup, Radio Setup, Radio Standard, WCDMA
Initial S/W Revision	A.05.00

Band II

Selects Band II as the band for the current step.

Key Path	Source, List Sequencer, List Sequencer Setup, Radio Setup, Radio Standard, WCDMA
Initial S/W Revision	A.05.00

Band III

Selects Band III as the band for the current step.

Key Path	Source, List Sequencer, List Sequencer Setup, Radio Setup, Radio Standard, WCDMA
Initial S/W Revision	A.05.00

Band IV

Selects Band IV as the band for the current step.

Key Path	Source, List Sequencer, List Sequencer Setup, Radio Setup, Radio Standard, WCDMA
Initial S/W Revision	A.05.00

Band V

Selects Band V as the band for the current step.

Key Path	Source, List Sequencer, List Sequencer Setup, Radio Setup, Radio Standard, WCDMA
Initial S/W Revision	A.05.00

Band VI

Selects Band VI as the band for the current step.

Key Path	Source, List Sequencer, List Sequencer Setup, Radio Setup, Radio Standard, WCDMA
Initial S/W Revision	A.05.00

Band VII

Selects Band VII as the band for the current step.

Key Path	Source, List Sequencer, List Sequencer Setup, Radio Setup, Radio Standard, WCDMA
Initial S/W Revision	A.05.00

Band VIII

Selects Band VIII as the band for the current step.

Key Path	Source, List Sequencer, List Sequencer Setup, Radio Setup, Radio Standard, WCDMA
Initial S/W Revision	A.05.00

Band IX

Selects Band IX as the band for the current step.

Key Path	Source, List Sequencer, List Sequencer Setup, Radio Setup, Radio Standard, WCDMA
Initial S/W Revision	A.05.00

Band X

Selects Band X as the band for the current step.

Key Path	Source, List Sequencer, List Sequencer Setup, Radio Setup, Radio Standard, WCDMA
Initial S/W Revision	A.05.00

Band XI

Selects Band XI as the band for the current step.

Key Path	Source, List Sequencer, List Sequencer Setup, Radio Setup, Radio Standard, WCDMA
Initial S/W Revision	A.05.00

Band XII

Selects Band XII as the band for the current step.

Key Path	Source, List Sequencer, List Sequencer Setup, Radio Setup, Radio Standard, WCDMA
Initial S/W Revision	A.05.00

Band XIII

Selects Band XIII as the band for the current step.

Key Path	Source, List Sequencer, List Sequencer Setup, Radio Setup, Radio Standard, WCDMA
Initial S/W Revision	A.05.00

Band XIV

Selects Band XIV as the band for the current step.

Key Path	Source, List Sequencer, List Sequencer Setup, Radio Setup, Radio Standard, WCDMA
Initial S/W Revision	A.05.00

LTE

Pressing this key once selects LTE FDD as the radio standard and the current LTE FDD band as the active channel band. Pressing this key again allows access to the sub-menus for selecting a different LTE FDD band.

Key Path	Source, List Sequencer, List Sequencer Setup, Radio Setup, Radio Standard
Initial S/W Revision	A.09.50

BAND 1

Selects BAND 1 as the band for the current step.

Key Path	Source, List Sequencer, List Sequencer Setup, Radio Setup, Radio Standard, LTE
Initial S/W Revision	A.09.50

BAND 2

Selects BAND 2 as the band for the current step.

Key Path	Source, List Sequencer, List Sequencer Setup, Radio Setup, Radio Standard, LTE
Initial S/W Revision	A.09.50

BAND 3

Selects BAND 3 as the band for the current step.

Key Path	Source, List Sequencer, List Sequencer Setup, Radio Setup, Radio Standard, LTE
Initial S/W Revision	A.09.50

BAND 4

Selects BAND 4 as the band for the current step.

Key Path	Source, List Sequencer, List Sequencer Setup, Radio Setup, Radio Standard, LTE
Initial S/W Revision	A.09.50

BAND 5

Selects BAND 5 as the band for the current step.

Key Path	Source, List Sequencer, List Sequencer Setup, Radio Setup, Radio Standard, LTE
Initial S/W Revision	A.09.50

BAND 6

Selects BAND 6 as the band for the current step.

Key Path	Source, List Sequencer, List Sequencer Setup, Radio Setup, Radio Standard, LTE
Initial S/W Revision	A.09.50

BAND 7

Selects BAND 7 as the band for the current step.

Key Path	Source, List Sequencer, List Sequencer Setup, Radio Setup, Radio Standard, LTE
Initial S/W Revision	A.09.50

BAND 8

Selects BAND 8 as the band for the current step.

Key Path	Source, List Sequencer, List Sequencer Setup, Radio Setup, Radio Standard, LTE
Initial S/W Revision	A.09.50

BAND 9

Selects BAND 9 as the band for the current step.

Key Path	Source, List Sequencer, List Sequencer Setup, Radio Setup, Radio Standard, LTE
Initial S/W Revision	A.09.50

BAND 10

Selects BAND 10 as the band for the current step.

Key Path	Source, List Sequencer, List Sequencer Setup, Radio Setup, Radio Standard, LTE
Initial S/W Revision	A.09.50

BAND 11

Selects BAND 11 as the band for the current step.

Key Path	Source, List Sequencer, List Sequencer Setup, Radio Setup, Radio Standard, LTE
Initial S/W Revision	A.09.50

BAND 12

Selects BAND 12 as the band for the current step.

Key Path	Source, List Sequencer, List Sequencer Setup, Radio Setup, Radio Standard, LTE
Initial S/W Revision	A.09.50

BAND 13

Selects BAND 13 as the band for the current step.

Key Path	Source, List Sequencer, List Sequencer Setup, Radio Setup, Radio Standard, LTE
Initial S/W Revision	A.09.50

BAND 14

Selects BAND 14 as the band for the current step.

Key Path	Source, List Sequencer, List Sequencer Setup, Radio Setup, Radio Standard, LTE
Initial S/W Revision	A.09.50

BAND 17

Selects BAND 17 as the band for the current step.

Key Path	Source, List Sequencer, List Sequencer Setup, Radio Setup, Radio Standard, LTE
Initial S/W Revision	A.09.50

BAND 18

Selects BAND 18 as the band for the current step.

Key Path	Source, List Sequencer, List Sequencer Setup, Radio Setup, Radio Standard, LTE
Initial S/W Revision	A.09.50

BAND 19

Selects BAND 19 as the band for the current step.

Key Path	Source, List Sequencer, List Sequencer Setup, Radio Setup, Radio Standard, LTE
Initial S/W Revision	A.09.50

BAND 20

Selects BAND 20 as the band for the current step.

Key Path	Source, List Sequencer, List Sequencer Setup, Radio Setup, Radio Standard, LTE
Initial S/W Revision	A.09.50

BAND 21

Selects BAND 21 as the band for the current step.

Key Path	Source, List Sequencer, List Sequencer Setup, Radio Setup, Radio Standard, LTE
Initial S/W Revision	A.09.50

BAND 24

Selects BAND 24 as the band for the current step.

Key Path	Source, List Sequencer, List Sequencer Setup, Radio Setup, Radio Standard, LTE
Initial S/W Revision	A.09.50

BAND 25

Selects BAND 25 as the band for the current step.

Key Path	Source, List Sequencer, List Sequencer Setup, Radio Setup, Radio Standard, LTE
Initial S/W Revision	A.09.50

BAND 26

Selects BAND 26 as the band for the current step.

Key Path	Source, List Sequencer, List Sequencer Setup, Radio Setup, Radio Standard, LTE
Initial S/W Revision	A.12.53

BAND 27

Selects BAND 27 as the band for the current step.

Key Path	Source, List Sequencer, List Sequencer Setup, Radio Setup, Radio Standard, LTE
Initial S/W Revision	A.14.00

BAND 28

Selects BAND 28 as the band for the current step.

Key Path	Source, List Sequencer, List Sequencer Setup, Radio Setup, Radio Standard, LTE
Initial S/W Revision	A.14.00

BAND 31

Selects BAND 31 as the band for the current step.

Key Path	Source, List Sequencer, List Sequencer Setup, Radio Setup, Radio Standard, LTE
Initial S/W Revision	A.14.00

LTE TDD

Sets LTE TDD as the radio standard for use and accesses the LTE TDD specific channel band sub-menus..

Key Path	Source, Frequency, Radio Setup, Radio Standard
Initial S/W Revision	A.11.50

BAND 33

Selects BAND 33 as the band for the current step.

Key Path	Source, Frequency, Radio Setup, Radio Standard, LTE TDD
Example	:SOUR:FREQ:CHAN:BAND BAND33
Initial S/W Revision	A.11.50

BAND 34

Selects BAND 34 as the band for the current step.

Key Path	Source, Frequency, Radio Setup, Radio Standard, LTE TDD
Example	:SOUR:FREQ:CHAN:BAND BAND34
Initial S/W Revision	A.11.50

BAND 35

Selects BAND 35 as the band for the current step.

Key Path	Source, Frequency, Radio Setup, Radio Standard, LTE TDD
Example	:SOUR:FREQ:CHAN:BAND BAND35
Initial S/W Revision	A.11.50

BAND 36

Selects BAND 36 as the band for the current step.

Key Path	Source, Frequency, Radio Setup, Radio Standard, LTE TDD
Example	:SOUR:FREQ:CHAN:BAND BAND36
Initial S/W Revision	A.11.50

BAND 37

Selects BAND 37 as the band for the current step.

Key Path	Source, Frequency, Radio Setup, Radio Standard, LTE TDD
Example	:SOUR:FREQ:CHAN:BAND BAND37
Initial S/W Revision	A.11.50

BAND 38

Selects BAND 38 as the band for the current step.

Key Path	Source, Frequency, Radio Setup, Radio Standard, LTE TDD
Example	:SOUR:FREQ:CHAN:BAND BAND38
Initial S/W Revision	A.11.50

BAND 39

Selects BAND 39 as the band for the current step.

Key Path	Source, Frequency, Radio Setup, Radio Standard, LTE TDD
Example	:SOUR:FREQ:CHAN:BAND BAND39
Initial S/W Revision	A.11.50

BAND 40

Selects BAND 40 as the band for the current step.

Key Path	Source, Frequency, Radio Setup, Radio Standard, LTE TDD
Example	:SOUR:FREQ:CHAN:BAND BAND40
Initial S/W Revision	A.11.50

BAND 41

Selects BAND 41 as the band for the current step.

Key Path	Source, Frequency, Radio Setup, Radio Standard, LTE TDD
Example	:SOUR:FREQ:CHAN:BAND BAND41
Initial S/W Revision	A.11.50

BAND 42

Selects BAND 42 as the band for the current step.

Key Path	Source, Frequency, Radio Setup, Radio Standard, LTE TDD
Example	:SOUR:FREQ:CHAN:BAND BAND42
Initial S/W Revision	A.11.50

BAND 43

Selects BAND 43 as the band for the current step.

Key Path	Source, Frequency, Radio Setup, Radio Standard, LTE TDD
Example	:SOUR:FREQ:CHAN:BAND BAND43
Initial S/W Revision	A.11.50

BAND 44

Selects BAND 44 as the band for the current step.

Key Path	Source, List Sequencer, List Sequencer Setup, Radio Setup, Radio Standard, LTE TDD
Initial S/W Revision	A.14.00

TDSCDMA

Sets TDSCDMA as the radio standard for use and accesses the TDSCDMA specific channel band sub-menus..

Key Path	Source, Frequency, Radio Setup, Radio Standard
Initial S/W Revision	A.11.50

BAND A

Selects BAND A as the band for the current step.

Key Path	Source, Frequency, Radio Setup, Radio Standard, TDSCDMA
Example	:SOUR:FREQ:CHAN:BAND BANDA
Initial S/W Revision	A.11.50

BAND B

Selects BAND B as the band for the current step.

Key Path	Source, Frequency, Radio Setup, Radio Standard, TDSCDMA
Example	:SOUR:FREQ:CHAN:BAND BANDB
Initial S/W Revision	A.11.50

BAND C

Selects BAND C as the band for the current step.

Key Path	Source, Frequency, Radio Setup, Radio Standard, TDSCDMA
Example	:SOUR:FREQ:CHAN:BAND BANDC
Initial S/W Revision	A.11.50

BAND D

Selects BAND D as the band for the current step.

Key Path	Source, Frequency, Radio Setup, Radio Standard, TDSCDMA
Example	:SOUR:FREQ:CHAN:BAND BANDD
Initial S/W Revision	A.11.50

BAND E

Selects BAND E as the band for the current step.

Key Path	Source, Frequency, Radio Setup, Radio Standard, TDSCDMA
Example	:SOUR:FREQ:CHAN:BAND BANDE
Initial S/W Revision	A.11.50

BAND F

Selects BAND F as the band for the current step.

Key Path	Source, Frequency, Radio Setup, Radio Standard, TDSCDMA
Example	:SOUR:FREQ:CHAN:BAND BANDF
Initial S/W Revision	A.11.50

Radio Band Link

Allows you to specify the radio band link direction for the steps within the list sequence. The link is used in conjunction with the channel band and channel number to determine the output frequency.

When set to “Uplink”, the source will calculate the uplink frequency according to an uplink formula together with selected channel band and channel number. When set to “Downlink”, the source will calculate the downlink frequency according to a downlink formula together with selected channel band and channel number.

Key Path	Source, List Sequencer, List Sequencer Setup, Radio Setup
Remote Command	:SOURce:LIST:STEP[1] 2 3...1000:SETup:RADio:BAND:LINK DOWN UP :SOURce:LIST:STEP[1] 2 3...1000:SETup:RADio:BAND:LINK?
Example	:SOUR:LIST:STEP2:SET:RAD:BAND:LINK UP :SOUR:LIST:STEP2:SET:RAD:BAND:LINK?
Notes	SCPI is supported after A.09.40
Preset	DOWN
Range	DOWN UP
Initial S/W Revision	A.05.00

Channel

Allows you to specify the frequency of the current step via a channel number.

Key Path	Source, List Sequencer, List Sequencer Setup
Remote Command	:SOURce:LIST:STEP[1] 2 3...1000:SETup:CNFRrequency <double> :SOURce:LIST:STEP[1] 2 3...1000:SETup:CNFRrequency?
Example	:SOUR:LIST:STEP2:SET:CNFR 124 :SOUR:LIST:STEP2:SET:CNFR?
Notes	SCPI is supported after A.09.40. This SCPI is used to setup channel number or frequency setting, according to current Radio Band setting. If Radio Band is "NONE", then it's frequency. If Radio Band is not "NONE", then it's channel number.
Couplings	The channel number is coupled to the step frequency value. When the step frequency value is changed, the channel number will increase or decrease to match the new step frequency. If the step frequency is not at an exact match for a channel number, the nearest channel number is displayed, along with a greater than, or less than sign to indicate the frequency is above or below the channel number.
Preset	1
Min	0 (Please refer to for valid ranges.)
Max	10838 (Please refer to for valid ranges.)
Initial S/W Revision	A.05.00

Frequency

Allows you to specify a frequency value for the current step.

Key Path	Source, List Sequencer, List Sequencer Setup
Remote Command	:SOURce:LIST:STEP[1] 2 3...1000:SETup:CNFRrequency <double> :SOURce:LIST:STEP[1] 2 3...1000:SETup:CNFRrequency?
Example	:SOUR:LIST:STEP2:SET:CNFR 1GHz :SOUR:LIST:STEP2:SET:CNFR?
Notes	SCPI is supported after A.09.40. This SCPI is used to setup channel number or frequency setting, according to current Radio Band setting. If Radio Band is "NONE", then it's frequency. If Radio Band is not "NONE", then it's channel number.
Couplings	The frequency value is coupled to the channel band and number for the step, such that updates to the radio band and channel number will update the frequency value to the corresponding absolute frequency. The reverse is also true, changing the frequency value causes the value of the channel number to be updated.
Preset	1.00 GHz
Min	10.00 MHz
Max	Hardware Dependant:

	Option 503 = 3.6 GHz Option 504 = 3.9 GHz Option 506 = 6.00 GHz
Initial S/W Revision	A.05.00

Power

Allows you to specify a power value for the current step.

Key Path	Source, List Sequencer, List Sequencer Setup
Remote Command	:SOURCE:LIST:STEP[1] 2 3...1000:SETup:AMPLitude <double> :SOURCE:LIST:STEP[1] 2 3...1000:SETup:AMPLitude?
Example	:SOUR:LIST:STEP2:SET:AMPL -50dBm :SOUR:LIST:STEP2:SET:AMPL?
Notes	SCPI is supported after A.09.40
Notes	Amplitude corrections can be specified for use with the source. In the event of amplitude corrections being applied, the valid ranges for the RF power do not change dependant on the current amplitude correction setting. Instead, if the combination of RF power + amplitude correction is higher or lower than the source output range, the Source Unleveled bit is set and the "Source Unleveled" indicator will appear on status panel to indicate that the source cannot maintain the output power that has been requested. The multiport adapter RFIO TX ports and GPS ports cannot ensure power accuracy when power setting is lower than -130dBm, this power setting value is defined by the sum of RF Power setting and related amplitude correction value. But user settable value could be lower than this limit. When application detected there exists power setting lower than -130dBm on MPA RFIO TX ports, then popup warning message . When application detected there exists power setting lower than -130dBm on MPA GPS ports, then popup warning message . These are only warning messages, and check is performed when RF is ON.
Notes	The Min and Max value here defined UI settable amplitude range. This range is larger than actual amplitude range with level accuracy defined in spec.
Dependencies	The RF power is dependent on the RF output port and frequency, such that the current frequency and selected output port determine the valid range of power values.
Preset	-100 dBm
Min	The range of values depends on the current frequency and selected RF output port. Please refer to "RF Power" on page 2098 and the table RF Power Range for the valid ranges.
Max	The range of values depends on the current frequency and selected RF output port. Please refer to "RF Power" on page 2098 and the table RF Power Range for the valid ranges.
Initial S/W Revision	A.05.00

Waveform

Allows you access to the sub-menus for selecting the waveform to be played back during the current step. Pressing this key also changes the central display area to show the Waveform File Selection view.

Key Path	Source, List Sequencer, List Sequencer Setup
Remote Command	:SOURce:LIST:STEP[1] 2 3...1000:SETup:WAVeform <string> :SOURce:LIST:STEP[1] 2 3...1000:SETup:WAVeform?
Example	:SOUR:LIST:STEP2:SET:WAV "CW" :SOUR:LIST:STEP2:SET:WAV?
Notes	SCPI is supported after A.09.40
Remote Command Notes	String type, takes "Off" "CW" "Cont" "waveform name"
Preset	CW
Range	Waveform Continue Previous CW Off
Initial S/W Revision	A.05.00

CW

Sets the current step to output a CW tone.

Key Path	Source, List Sequencer, List Sequencer Setup, Waveform
Example	:SOUR:LIST:STEP2:SET:WAV "CW"
Notes	SCPI is supported after A.09.40
Initial S/W Revision	A.05.00

Selected Waveform

Inserts the currently selected waveform in the waveform selection view as the waveform for playback during the current step.

Key Path	Source, List Sequencer, List Sequencer Setup, Waveform
Example	:SOUR:LIST:STEP2:SET:WAV "waveform name"
Notes	SCPI is supported after A.09.40 If the selected waveform contains header (which contains ARB play parameters), source list sequence will automatically apply header settings of the selected waveform in that step.
Initial S/W Revision	A.05.00

Continue Previous

Sets the current step to continue with playback of the waveform from the previous step. When continuing the previous waveform, the ARB playback will not pause while the source retunes to the new frequency or amplitude that may be defined for the new step.

Key Path	Source, List Sequencer, List Sequencer Setup, Waveform
----------	--

Example	:SOUR:LIST:STEP2:SET:WAV "Cont"
Notes	SCPI is supported after A.09.40
Initial S/W Revision	A.05.00

Off

Disable RF output of the current step.

Key Path	Source, List Sequencer, List Sequencer Setup, Waveform
Example	:SOUR:LIST:STEP2:SET:WAV "Off"
Notes	SCPI is supported after A.09.40
Initial S/W Revision	A.05.00

Segments on Hard Disk

Allows you access to the sub-menus for loading waveform segments from the hard disk into ARB memory. The default directory is: D: varb.

Pressing this key changes the current view to the Waveform Management View.

Key Path	Source, Modulation Setup, ARB, Select Waveform
Initial S/W Revision	A.05.00

Load Segment To ARB Memory

Allows you to load the selected file into ARB memory. On the front panel you select the file for loading to the ARB memory by highlighting the desired file in the list. Using the SCPI command, you specify the file name on the HDD.

"NVWFM" (none-volatile storage) MSUS (Mass Storage Unit Specifier) is supported in the memory subsystem because the ARB memory cannot be accessed directly. Therefore, files must be downloaded to the instrument hard disk and then loaded into the ARB memory. "NVWFM" MSUS will be mapped to the default directory D: VARB. The SCPI command supports using either "NVWFM" MSUS or specifying a full path. For more information, see Memory Subsystem (Remote Command Only).

If a file of the same name already exists within ARB memory, it is overwritten. If you wish to load two segments of the same name, you must rename one of the segments before loading it into ARB memory. To rename a segment, you can either use Windows File Explorer, or the :MMEMory:COPY command.

NOTE: When a waveform file is loaded to ARB memory, burst timing adjustments are made automatically, based on whether or not a Multiport Adapter is connected to the test set and powered on. If the connection/power status of the Multiport Adapter is changed after a waveform file has been loaded, it needs to be loaded again.

Key Path	Source, Modulation Setup, ARB, Select Waveform, Segments on Hard Disk
Remote Command	:SOURce:RADio:ARB:LOAD <string>
Example	:SOUR:RAD:ARB:LOAD "D: VARB\testwaveform.bin" or :SOUR:RAD:ARB:LOAD "NVWFM:testwaveform.bin"
Notes	<p>Because loading the file involves a delay of unpredictable length, this command should be followed by the query *OPC?, which holds off subsequent commands until the loading operating is complete.</p> <p><string> – specifies the path name of the file to load from the HDD into ARB memory. It could be a <full path + filename>, or <"NVWFM" MSUS + colon + filename>.</p> <p>When in Sequence Analyzer mode, and Include Source is Yes, an attempt to load a file to ARB memory will be rejected with an error.</p> <p>When Include Source is No and if there is insufficient free ARB memory to load the selected waveform, an error is generated. .</p> <p>If you specify a file over SCPI, but the file is not at the specified location, an error is generated.</p> <p>If you try to load a waveform file but the file contains less than 500 IQ samples, an error is generated.</p> <p>If you try to load a Signal Studio waveform "*.wfm" which contains invalid waveform header, an error is generated.</p> <p>If the ARB is ON when you load a file to ARB memory or delete a file from ARB memory, the playing waveform segment may not keep phase continuity during the ARB memory operation. The waveform will be replayed after the ARB operation is finished.</p> <p>ARB can be loaded into ARB memory even required licenses do not present on the instrument. In this case, a GUI only warning message -800, "Operation complete; Loaded <filename> successfully, but no license <required licenses> installed". User can install required licenses according to <required licenses> string to license it, or multi-pack license it.</p>
Initial S/W Revision	A.05.00

Load All To ARB Memory

Allows you to load all the segment files within the currently selected directory into ARB memory. If a file of the same name already exists within ARB memory, it is overwritten. If you wish to load two segments of the same name, you must rename one of the segments before loading it into ARB memory. To rename a segment, you can either use Windows File Explorer, or the :MEMory:COpy command.

NOTE: When a waveform file is loaded to ARB memory, burst timing adjustments are made automatically, based on whether or not a Multiport Adapter is connected to the test set and powered on. If the connection/power status of the Multiport Adapter is changed after a waveform file has been loaded, it needs to be loaded again.

Key Path	Source, Modulation Setup, ARB, Select Waveform, Segments on Hard Disk
Remote Command	:SOURce:RADio:ARB:LOAD:ALL <string>
Example	:SOUR:RAD:ARB:LOAD:ALL "D: varb"
Notes	<p><string> - specifies the directory on the HDD to load the files into ARB memory from.</p> <p>When in Sequence Analyzer mode, and Include Source is Yes, an attempt to load all files from a directory to ARB memory is rejected with an error.</p>

When Include Source is No and there is insufficient free ARB memory to load all the waveforms, when the ARB memory is full, the copy ceases, and an error is generated.

If you specify a directory over SCPI, but the directory does not exist, an error is generated.

If the ARB is ON, a user then loads or deletes file to ARB memory, the playing waveform segment may not keep phase continuity during the ARB memory operation. The waveform will be replayed after the ARB operation is finished.

Initial S/W Revision	A.05.00
----------------------	---------

Change Directory...

Allows you to change the currently selected directory on the hard disk. Pressing this key opens a standard windows change directory dialog allowing you to select the new directory of interest.

The current directory is used for manually loading waveform segments into ARB memory for playback, and as a search location for waveform segments that are required to be loaded into ARB memory for playback of a waveform sequence or a list sequence.

Key Path	Source, Modulation Setup, ARB, Select Waveform, Segments on Hard Disk
Notes	No remote command, SCPI front panel only.
Initial S/W Revision	A.05.00

Default Directory...

Allows you to change the default directory. It is used as a search location for waveform segments that are required to be loaded into ARB memory for playback of a waveform sequence, and as a search location for selecting waveforms using SCPI.

Key Path	Source, Modulation Setup, ARB, Select Waveform, Segments on Hard Disk
Remote Command	:SOURce:RADio:ARB:DEFault:DIRectory <string> :SOURce:RADio:ARB: DEFault:DIRectory?
Example	:SOUR:RAD:ARB:DEF:DIR "D:\ArbFiles" :SOUR:RAD:ARB:DEF:DIR?
State Saved	Persistent, survives a power cycle and a preset but not saved in the instrument state
Initial S/W Revision	A.05.00

Segments in ARB Memory

Allows you access to the sub-menus for managing the files within ARB memory.

Key Path	Source, Modulation Setup, ARB, Select Waveform
Initial S/W Revision	A.05.00

Delete Segment From ARB Mem

Allows you to remove a segment from ARB playback memory.

Key Path	Source, Modulation Setup, ARB, Select Waveform, Segments in ARB Memory
Remote Command	:SOURce:RADio:ARB:DELeTe <string>
Example	:SOUR:RAD:ARB:DEL "testwaveform.bin"
Notes	<p><string> - specifies the waveform to be deleted from the ARB playback memory.</p> <p>When in Sequence Analyzer mode and Include Source is Yes, an attempt to delete a file from ARB memory is rejected with an error.</p> <p>When Include Source is No and you specify a file that does not exist within ARB memory, an error is generated.</p> <p>It is possible to delete files from within the ARB memory when the ARB is ON. However, if you attempt to delete the file that is currently playing an error is generated.</p> <p>It is possible to delete a file from within the ARB memory when the sequencer state is ON and the file is not being used by the List Sequencer. If you attempt to delete a file which is being used by the list sequencer, an error is generated.</p> <p>When sequencer state is On, even if ARB state is On, the selected waveform will not be played. In this case, if the selected waveform is not used in List Sequence, it can be deleted and the ARB state is turned Off.</p> <p>If the ARB is ON and you load a file to ARB memory or delete a file from ARB memory, the playing waveform segment may not keep phase continuity during the ARB memory operation. The waveform will be replayed after the ARB operation is finished.</p>
Initial S/W Revision	A.05.00

Delete All From ARB Memory

Allows you to remove all segments from ARB playback memory.

Key Path	Source, Modulation Setup, ARB, Select Waveform, Segments in ARB Memory
Remote Command	:SOURce:RADio:ARB:DELeTe:ALL
Example	:SOUR:RAD:ARB:DELeTe:ALL
Notes	<p>When in Sequence Analyzer mode and Include Source is Yes, an attempt to delete all files from ARB memory is rejected with an error.</p> <p>When Include Source is No and you attempt to delete all files from ARB memory when the ARB is currently playing a file, all files except the one playing are deleted and an error is generated.</p> <p>If you attempt to delete all files from ARB memory when there are waveform files used in "List Sequencer" on page 2168 and "Sequencer" on page 2168 state is ON, all files except the files currently being used in list sequencer are deleted, and an error is generated.</p> <p>If the ARB is ON and you load a file to ARB memory or delete a file from ARB memory, the playing waveform segment may not keep phase continuity during the ARB memory operation. The waveform will be replayed after the ARB operation is finished.</p>
Initial S/W Revision	A.05.00

Step Duration

Allows access to the sub-menus for setting up the duration of play for the current step.

The duration can be set to be either the number of times for the ARB file associated with the sequence to play, or a specific time value, or continuous. If the step is set to play a CW tone, the step duration cannot be set to a play count.

Key Path	Source, List Sequencer, List Sequencer Setup
Remote Command	:SOURce:LIST:STEP[1] 2 3...1000:SETup:DURation:TYPE TIME COUNT CONTInuous CABort :SOURce:LIST:STEP[1] 2 3...1000:SETup:DURation:TYPE?
Example	:SOUR:LIST:STEP2:SET:DUR:TYPE TIME :SOUR:LIST:STEP2:SET:DUR:TYPE?
Notes	SCPI is supported after A.09.40
Notes	If “Step Duration” is set to “Time” or “Play Count” for the last step, the last step of ARB keeps playing as if set to “Continuous”, until the set “Time” has expired or until the “Play Count” setting is reached. However, you can query Error! Reference source not found. Source Sweeping Condition Message to find out if the current list sequence is complete or not.
Range	Time Play Count Continuous Continuous Abort
Initial S/W Revision	A.05.00

Time

Sets the duration of the current step to be a time value for the length of time the step will play. Pressing this key again opens another menu which allows you to set the time value for the step duration.

Key Path	Source, List Sequencer, List Sequencer Setup, Step Duration
Example	:SOUR:LIST:STEP2:SET:DUR:TYPE TIME
Notes	SCPI is supported after A.09.40
Initial S/W Revision	A.05.00

Duration Time

Allows you to specify the length of time the current step will play.

If the Transition Time value is longer than the Step Duration Time, an error is generated when initiating a source list sequence. For source list sequence, transition time is included in the step duration length (not occupy additional time). If the Transition Time value is longer than the Step Duration Time, the real step duration length is extended to equal the transition time and cause a timing shift. This check is also described in section **Error! Reference source not found.** List Sequence Step Validation.

Key Path	Source, List Sequencer, List Sequencer Setup, Step Duration, Time
Remote Command	:SOURce:LIST:STEP[1] 2 3...1000:SETup:DURation:TCOUNT <double> :SOURce:LIST:STEP[1] 2 3...1000:SETup:DURation:TCOUNT?

Example	:SOUR:LIST:STEP2:SET:DUR:TCO 1s :SOUR:LIST:STEP2:SET:DUR:TCO?
Notes	SCPI is supported after A.09.40 This SCPI is reused by "Play Count", "Duration Time" and "Continuous Abort" according to current Duration Type setting is "Play Count" or "Duration Time" or "Continuous Abort". If current "Duration Type" is "Continuous", then popup error -221, "Settings conflict; Cannot accept time or count input when step duration type is Continuous on step #"
Notes	If "Duration Time" is set for the last step, the last step of ARB keeps playing as if set to "Continuous" after set time expires. However, you can query Source Sweeping Condition Message (:STAT:OPER:COND?) to find out if the current list sequence is complete or not.
Preset	1.00 ms
Min	100 μs
Max	1800 s
Initial S/W Revision	A.05.00

Play Count

Sets the duration of the current step to be an integer value for the number of times (play count) the ARB file is selected for playback during this step. For example, a 5 second ARB will be set to play 5 times during the step.

Key Path	Source, List Sequencer, List Sequencer Setup, Step Duration
Example	:SOUR:LIST:STEP2:SET:DUR:TYPE COUN
Notes	SCPI is supported after A.09.40 This key is unavailable and is grayed out if the current step is configured to CW tone rather than an ARB waveform.
Initial S/W Revision	A.05.00

Header Utilities

Allows access to the header utilities sub-menu. Pressing this key also causes the central display area to change to display the File Header Information view.

Key Path	Source, Modulation Setup, ARB
Dependencies	This key is only available if there is currently a waveform selected for playback. If no waveform is selected, the key is grayed out.
Initial S/W Revision	A.05.00

Continuous

Sets the current step to be played continuously until the next step starts. The waveform will always play completely before transitioning to the next step.

Key Path	Source, List Sequencer, List Sequencer Setup, Step Duration
Example	:SOUR:LIST:STEP2:SET:DUR:TYPE CONT
Notes	SCPI is supported after A.09.40
Initial S/W Revision	A.05.00

Output Trigger

Allows you to specify the trigger output for the current step. The trigger output signal is sent at the start of the step.

When select “On”, trigger event will occur on both Internal and External2 paths. Select “Off” will turn off trigger output.

Key Path	Source, List Sequencer, List Sequencer Setup
Remote Command	:SOURce:LIST:STEP[1] 2 3...1000:SETup:OUTPut:TRIGger ON OFF 1 0 :SOURce:LIST:STEP[1] 2 3...1000:SETup:OUTPut:TRIGger
Example	:SOUR:LIST:STEP2:SET:OUTP:TRIG ON :SOUR:LIST:STEP2:SET:OUTP:TRIG?
Notes	SCPI is supported after A.09.40
Preset	Off
Range	On Off
Initial S/W Revision	A.05.00

Repetition

Allows access to the sub-menu for selecting the repetition type for the list sequencer globally. It cannot be changed between different sequence steps.

Key Path	Source, List Sequencer
Remote Command	:SOURce:LIST:REPetition:TYPE SINGLE CONTInuous
Example	:SOUR:LIST:REP:TYPE SING :SOUR:LIST:REP:TYPE?
Preset	SINGle
Range	SINGle CONTInuous
Initial S/W Revision	A.14.50

Single

Sets the repetition type as single for the whole source sequence. Source list will play one time after initiation.

Key Path	Source, List Sequencer, Repetition
Example	:SOUR:LIST:REP:TYPE SINGLE
Initial S/W Revision	A.14.50

Continuous

Sets the repetition type as continuous for the whole source sequence. Source list will play continuously after initiation.

Key Path	Source, List Sequencer, Repetition
Example	:SOUR:LIST:REP:TYPE CONTInuous
Initial S/W Revision	A.14.50

Trigger Type

Allows access to the sub-menu for selecting the output trigger type for the list sequencer globally. It cannot be changed between different sequence steps.

Key Path	Source, List Sequencer
Remote Command	:SOURce:LIST:TRIGgerout:TYPe BEGInningofstep DATAmarker
Example	:SOUR:LIST:TRIG:TYP BEG :SOUR:LIST:TRIG:TYP?
Notes	SCPI is supported after A.14.00
Preset	BEGInningofstep
Range	BEGInningofstep DATAmarker
Initial S/W Revision	A.14.00

BeginningOfStep

Sets the output trigger type as BeginningOfStep for the whole source sequence.

Key Path	Source, List Sequencer, Trigger Type
Example	:SOUR:LIST:TRIG:TYP BEG
Notes	SCPI is supported after A.14.00
Initial S/W Revision	A.14.00

DataMarker

Sets the output trigger type as DataMarker for the whole source sequence. When DataMarker is selected, which marker to route is also needed to be set.

Key Path	Source, List Sequencer, Trigger Type
Example	:SOUR:LIST:TRIG:TYP DAT
Notes	SCPI is supported after A.14.00
Initial S/W Revision	A.14.00

Marker 1

Sets the output trigger maker routing to Marker 1 for DataMarker in the whole source sequence.

Key Path	Source, List Sequencer, Trigger Type, DataMarker
Example	:SOUR:LIST:TRIG:TYPE:MARK M1
Notes	SCPI is supported after A.14.00
Initial S/W Revision	A.14.00

Marker 2

Sets the output trigger maker routing to Marker 2 for DataMarker in the whole source sequence.

Key Path	Source, List Sequencer, Trigger Type, DataMarker
Example	:SOUR:LIST:TRIG:TYPE:MARK M2
Notes	SCPI is supported after A.14.00
Initial S/W Revision	A.14.00

Marker 3

Sets the output trigger maker routing to Marker 3 for DataMarker in the whole source sequence.

Key Path	Source, List Sequencer, Trigger Type, DataMarker
Example	:SOUR:LIST:TRIG:TYPE:MARK M3
Notes	SCPI is supported after A.14.00
Initial S/W Revision	A.14.00

Marker 4

Sets the output trigger maker routing to Marker 4 for DataMarker in the whole source sequence.

Key Path	Source, List Sequencer, Trigger Type, DataMarker
Example	:SOUR:LIST:TRIG:TYPE:MARK M4
Notes	SCPI is supported after A.14.00
Initial S/W Revision	A.14.00

Manual Trigger Now

Pressing this key provides a software trigger event to the list sequencer. During execution of sequence, if the sequencer is halted on any step that has been configured with a “Manual” step trigger, then this key press will cause the sequencer to continue and execute the step.

Key Path	Source, List Sequencer
Remote Command	No remote command, front panel only.
Initial S/W Revision	A.05.00

Source Preset

Allows you to preset the source settings to their default values.

Key Path	Source
Remote Command	:SOURce:PRESet
Example	:SOUR:PRES

Span X Scale

Accesses a menu of functions that enable you set the horizontal scale parameters.

Key Path	Front-panel key
Initial S/W Revision	Prior to A.02.00

Span

Changes the frequency range symmetrically about the center frequency.

The default (and minimum) Span is calculated using the number of carriers and the carrier width where;

$$\text{Span} = (\text{Upper Carrier Freq} + (\text{max offset IBW} * (1 + \alpha)) / 2) - (\text{Lower Carrier Freq} - (\text{max offset IBW} * (1 + \alpha)) / 2)$$

The span is increased by a factor of 1 + Filter Alpha if the RRC Filter is on.

Key Path	Span X Scale
Mode	SA, WCDMA, C2K, WIMAX OFDMA, 1xEVDO, DVB-T/H, DTMB (CTTB), ISDB-T, CMMB, LTE, LTETDD, Digital Cable TV, WLAN, LTEAFDD, LTEATDD
Remote Command	[:SENSe] :CHPower:FREQuency:SPAN <freq> [:SENSe] :CHPower:FREQuency:SPAN?
Example	CHP:FREQ:SPAN 10 MHz CHP:FREQ:SPAN?
Notes	You must be in the Spectrum Analysis mode, W-CDMA mode, cdma2000 mode, DVB-T/H mode, DTMB (CTTB) mode, ISDB-T mode, CMMB mode, Digital Cable TV mode, LTE mode, LTE TDD mode, WLAN mode, 1xEVDO mode or WIMAX OFDMA mode to use this command. Use :INSTrument:SElect to set the mode.
Dependencies	For MSR mode, this key is blank. For LTE-Advanced FDD/TDD mode, this key is blank. In order to keep backwards compatible with the legacy LTE FDD/TDD, the scpi command is supported in LTE & LTE-A converged application. For WLAN 802.11ac (80 MHz + 80 MHz), the key is not enabled and its value is coupled with the spacing between the center frequencies of the two carriers. Span = Center Frequency 1 - Center Frequency 2 + Integ BW + 40 MHz Margin. When the calculated span is over 1 GHz, it's still coupled to its maximum value, which is 1 GHz.
Couplings	When Res BW is set to Auto, the resolution bandwidth is auto-coupled to span. The ratio of span /RBW is approximately 106:1. When the Res BW is set to Man, bandwidths are entered by the user, and these bandwidths are used regardless of other analyzer settings. Since Span is coupled to Integ BW in the factory default condition, if you change the integration bandwidth setting, the span setting changes by a proportional amount until a limit value is reached. However, the span can be individually set. The minimum value of the span is coupled with the integration bandwidth.

Preset	SA: 3 MHz WCDMA: 7.5 MHz C2K: 1.845 MHz WIMAX OFDMA: 20 MHz 1xEVDO: 2.0MHz DVB-T/H: 10MHz DTMB (CTTB): 10MHz ISDB-T: 10MHz CMMB: 10MHz LTE: 7.5 MHz LTETDD: 7.5 MHz Digital Cable TV: 10MHz WLAN: if Radio Std is 802.11a/g(OFDM/DSSS-OFDM): 30 MHz if Radio Std is 802.11b: 37.5MHz if Radio Std is 802.11n(20MHz): 30 MHz if Radio Std is 802.11n(40MHz): 60 MHz if Radio Std is 802.11ac (20 MHz): 30 MHz if Radio Std is 802.11ac (40 MHz): 60 MHz if Radio Std is 802.11ac (80 MHz): 120 MHz if Radio Std is 802.11ac (160 MHz): 240 MHz if Radio Std is 802.11ac (80 MHz + 80 MHz): 360 MHz
State Saved	Saved in instrument state.
Min	100 Hz
Max	Hardware Maximum Span
Initial S/W Revision	Prior to A.02.00
Modified at S/W Revision	A.02.00, A.03.00, A14.50

Full Span

Changes the span to show the full frequency range of the spectrum analyzer.

Key Path	Span X Scale
Mode	SA, WCDMA, C2K, WIMAX OFDMA, 1xEVDO, DVB-T/H, DTMB (CTTB), ISDB-T, CMMB, LTE, LTETDD, Digital Cable TV, WLAN, LTEAFDD, LTEATDD
Remote Command	[:SENSe] :CHPower:FREQuency:SPAN:FULL
Example	CHP:FREQ:SPAN:FULL
Notes	You must be in the Spectrum Analysis mode, W-CDMA mode, cdma2000 mode, DVB-T/H mode, DTMB (CTTB) mode, ISDB-T mode, CMMB mode, Digital Cable TV mode, LTE mode, LTE TDD mode,

	WLAN mode, 1xEVDO mode or WIMAX OFDMA mode to use this command. Use :INSTrument:SElect to set the mode.
Dependencies	For MSR mode, this key is blank. For LTE-Advanced FDD/TDD mode, this key is blank. In order to keep backwards compatible with the legacy LTE FDD/TDD, the scpi command is supported in LTE & LTE-A converged application
Couplings	Selecting full span changes the measurement span value.
Initial S/W Revision	Prior to A.02.00
Modified at S/W Revision	A.02.00, A.03.00

Last Span

Changes the span to the previous span setting. If no previous span value exists, then the span remains unchanged.

Key Path	Span X Scale
Mode	SA, WCDMA, C2K, WIMAX OFDMA, 1xEVDO, DVB-T/H, DTMB (CTTB), ISDB-T, CMMB, LTE, LTETDD, Digital Cable TV, WLAN, LTEAFDD, LTEATDD
Remote Command	[:SENSe] :CHPower :FREQuency:SPAN:PREVIOUS
Example	CHP:FREQ:SPAN:PREV
Notes	You must be in the Spectrum Analysis mode, W-CDMA mode, cdma2000 mode, DVB-T/H mode, DTMB (CTTB) mode, ISDB-T mode, CMMB mode, Digital Cable TV mode, LTE mode, LTE TDD mode, WLAN mode, 1xEVDO mode or WIMAX OFDMA mode to use this command. Use :INSTrument:SElect to set the mode.
Dependencies	For MSR mode, this key is blank. For LTE-Advanced FDD/TDD mode, this key is blank. In order to keep backwards compatible with the legacy LTE FDD/TDD, the scpi command is supported in LTE & LTE-A converged application
Couplings	Selecting last span changes the measurement span value.
Initial S/W Revision	Prior to A.02.00
Modified at S/W Revision	A.02.00, A.03.00, A.14.50

Sweep/Control

Accesses a menu of functions that enable you to set up and control the sweep time and source for the current measurement. See Key and Command Descriptions – Sweep/Control for more information.

Key Path	Front-panel key
Initial S/W Revision	Prior to A.02.00

Sweep Time

Selects the length of time that the spectrum analyzer sweeps the displayed frequency span. Additional overhead time, which impacts the sweep rate, is not calculated as part of the sweep time. In fact:

$$\text{sweep rate} = \text{span} / \text{sweep time}$$

$$\text{update rate} = 1 / (\text{sweep time} + \text{overhead})$$

$$\text{sweep cycle time} = \text{sweep time} + \text{overhead}$$

Sweep time is coupled to RBW and VBW, and is impacted by the number of sweep points, so changing those parameters may change the sweep time.

Key Path	Sweep/Control
Mode	SA, WCDMA, C2K, WIMAX OFDMA, 1xEVDO, DVB-T/H, DTMB (CTTB), ISDB-T, CMMB, LTE, LTETDD, Digital Cable TV, WLAN, MSR, LTEAFDD, LTEATDD
Remote Command	[:SENSe]:CHPower:SWEep:TIME <time> [:SENSe]:CHPower:SWEep:TIME? [:SENSe]:CHPower:SWEep:TIME:AUTO OFF ON 0 1 [:SENSe]:CHPower:SWEep:TIME:AUTO?
Example	CHP:SWE:TIME 25ms CHP:SWE:TIME? CHP:SWE:TIME:AUTO OFF CHP:SWE:TIME:AUTO?
Preset	SA, WIMAX OFDMA: Automatically Calculated WCDMA: 1.0 ms CDMA2K: 9.4ms 1xEVDO: 2.66ms DVB-T/H: Automatically Calculated DTMB (CTTB): Automatically Calculated ISDB-T: Automatically Calculated CMMB: Automatically Calculated LTE, MSR: Automatically Calculated LTETDD: Automatically Calculated Digital Cable TV: Automatically Calculated

	WLAN: Automatically Calculated LTEAFDD,LTEATDD:Automatically Calculated
State Saved	Saved in instrument state.
Min	1 ms
Max	4000 s
Initial S/W Revision	Prior to A.02.00
Modified at S/W Revision	A.02.00, A.03.00

Sweep Setup

Accesses a menu that enables you to set the sweep state for the current measurement.

Key Path	Sweep/Control
Initial S/W Revision	Prior to A.02.00

Auto Sweep Time Rules

Switches the analyzer between normal and accuracy sweep states.

Setting Auto Sweep Time to Accy results in slower sweep times, usually about three times as long, but yields better amplitude accuracy for CW signals. The instrument amplitude accuracy specifications only apply when Auto Sweep Time is set to Accy.

Additional amplitude errors which occur when Auto Sweep Time is set to Norm are usually well under 0.1 dB, though this is not guaranteed. Because of the faster sweep times and still low errors, Norm is the preferred setting of Auto Sweep Time. Auto Sweep Time is set to Norm on a Preset or Auto Couple. This means that in the Preset or Auto Coupled state, instrument amplitude accuracy specifications do not apply.

Key Path	Sweep/Control, Sweep Setup
Mode	SA, WCDMA, C2K, WIMAX OFDMA, 1xEVDO, DVB-T/H, DTMB (CTTB), ISDB-T, CMMB, LTE, LTEATDD, Digital Cable TV, WLAN, MSR, LTEAFDD, LTEATDD
Remote Command	[:SENSe] :CHPower:SWEep:TIME:AUTO:RULEs NORMal ACCuracy [:SENSe] :CHPower:SWEep:TIME:AUTO:RULEs?
Example	CHP:SWE:TIME:AUTO:RUL NORM CHP:SWE:TIME:AUTO:RUL?
Notes	In Zero Span, this key is irrelevant and inaccessible (because the whole Sweep Setup menu is grayed out in Zero Span), however its settings can be changed remotely with no error indication. Set to Norm when Auto Couple is pressed or sent remotely

Preset	NORMal
State Saved	Saved in instrument state.
Range	Norm Accy
Initial S/W Revision	Prior to A.02.00
Modified at S/W Revision	A.02.00, A.03.00

Pause

Pauses a measurement after the current data acquisition is complete. When Paused, the label on the key changes to Resume. Pressing the Resume key resumes the measurement at the point it was at when paused. See Pause/Resume for more details.

Key Path	Sweep/Control
Initial S/W Revision	Prior to A.02.00

Gate

Accesses a menu that enables you to control the gating function. The Gate functionality is used to view signals best viewed by qualifying them with other events.

Gate setup parameters are the same for all measurements – they do not change as you change measurements. Settings like these are called “Meas Global” and are unaffected by Meas Preset.

Key Path	Sweep/Control
Scope	Meas Global
Readback	The state and method of Gate, as [Off, FFT] or [On, FFT]. Note that for measurements that only support gated FFT, the method is nonetheless read back, but always as FFT.
Initial S/W Revision	Prior to A.02.00

Gate On/Off

Turns the gate function on and off.

When the Gate Function is on, the selected Gate Method is used along with the gate settings and the signal at the gate source to control the sweep system with the gate signal. Not all measurements allow every type of Gate Methods.

When Gate is on, the annunciation in the measurement bar reflects that it is on and what method is used, as seen in the following "Gate: FFT" annunciator graphic.

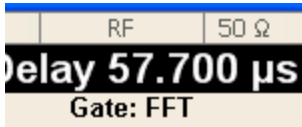

Key Path	Sweep/Control, Gate
Remote Command	[:SENSe] :SWEep:EGATe [:STATe] OFF ON 0 1 [:SENSe] :SWEep:EGATe [:STATe] ?
Example	SWE:EGAT ON SWE:EGAT?
Dependencies	<p>When in the ACP measurement:</p> <ul style="list-style-type: none"> • When Meas Method is RBW or FAST, this function is unavailable and the key is grayed out. • Whenever Gate is on, Meas Method, RBW or FAST is unavailable and keys for those are grayed out. • When Gate is on, Offset Res BW and Offset Video BW are ignored (if you set these values) and the measurement works as if all Offset Res BW and all Offset Video BW are coupled with the Res BW and the Video BW under the BW menu. When Gate is on, the Offset BW key in the Offset/Limit menu is grayed out.
Preset	Off LTETDD: On
State Saved	Saved in instrument state
Range	On Off
Backwards Compatibility SCPI	[:SENSe] :SWEep:TIME:GATE [:STATe] ESA compatibility
Backwards Compatibility Notes	In ESA, Trig Delay (On) and Gate (On) could not be active at the same time.. This dependency does not exist in PSA or in the X-Series.
Initial S/W Revision	Prior to A.02.00

Gate View On/Off

Turning on Gate View in the Swept SA measurement provides a single-window gate view display..

Turning on Gate View in other measurements shows the split-screen Gate View. In these measurements, when the Gate View is on, the regular view of the current measurement traces and results are reduced vertically to about 70% of the regular height. The Zero Span window, showing the positions of the Gate, is shown between the Measurement Bar and the reduced measurement window. By reducing the height of the measurement window, some of the annotation on the Data Display may not fit and is not shown.

Key Path	Sweep/Control, Gate
Remote Command	[:SENSe] :SWEep:EGATe:VIEW ON OFF 1 0 [:SENSe] :SWEep:EGATe:VIEW?
Example	SWE:EGAT:VIEW ON turns on the gate view.

Dependencies	<p>In the Swept SA measurement:</p> <p>In Gate View, the regular Acq Time key is grayed out . When pressed, the grayed out key puts up the informational message "Use Gate View Sweep Time in the Gate menu."</p> <p>In the other measurements:</p> <p>When you turn Gate View on, the lower window takes on the current state of the instrument. Upon leaving Gate View, the instrument takes on the state of the lower window.</p> <p>When you turn Gate View on, the upper window Acquisition Time is set to the gate view acquisition time.</p>
Couplings	<p>These couplings apply to the Swept SA measurement:</p> <ul style="list-style-type: none">• When Gate View is turned on, the instrument is set to Zero Span.• Gate View automatically turns off whenever a Span other than Zero is selected.• Gate View automatically turns off if you press the Last Span key while in Gate View, and the instrument returns to the Span it was in before entering Gate View (even if that is Zero Span).• When Gate View is turned on, the sweep time used is the gate view sweep time. This is set according to the rules in section "Gate View Setup " on page 1437• When Gate View is turned off, Sweep Time is set to the normal Swept SA measurement sweep time.• If Gate View is on and Gate is off, then turning on Gate turns off Gate View.
Preset	OFF
State Saved	Saved in instrument state
Range	On Off
Initial S/W Revision	Prior to A.02.00

A sample of the Gate View screen in the Swept SA measurement is shown in the following graphic :

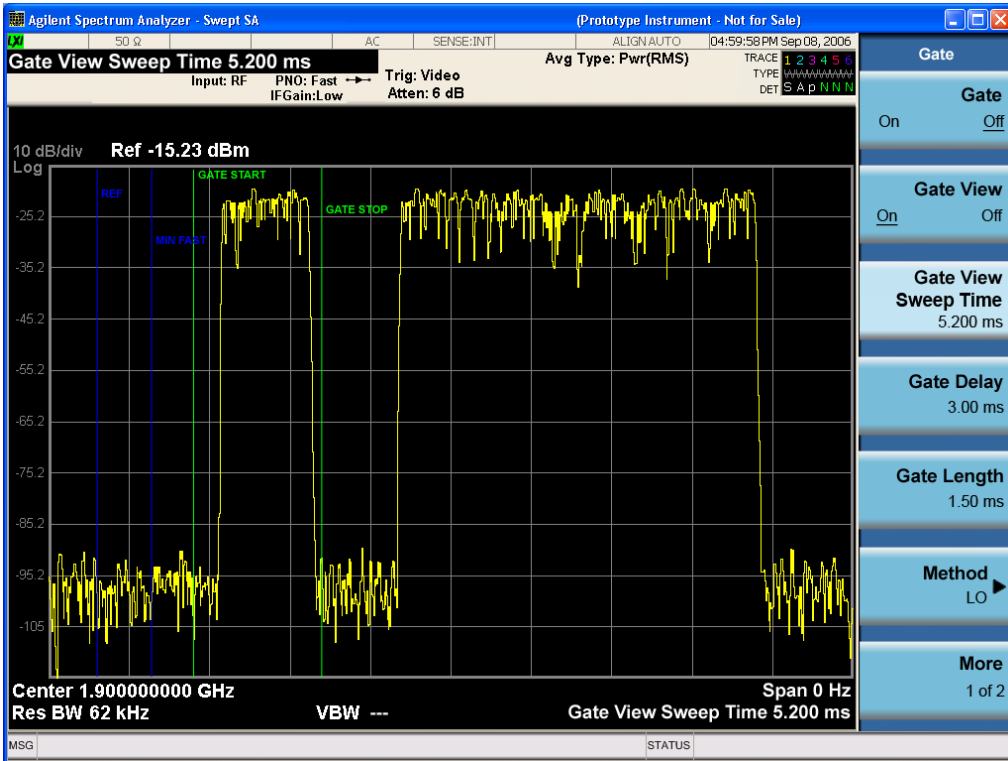

A sample of the Gate View screen in other measurements is shown in the following graphic . This example is for the ACP measurement:

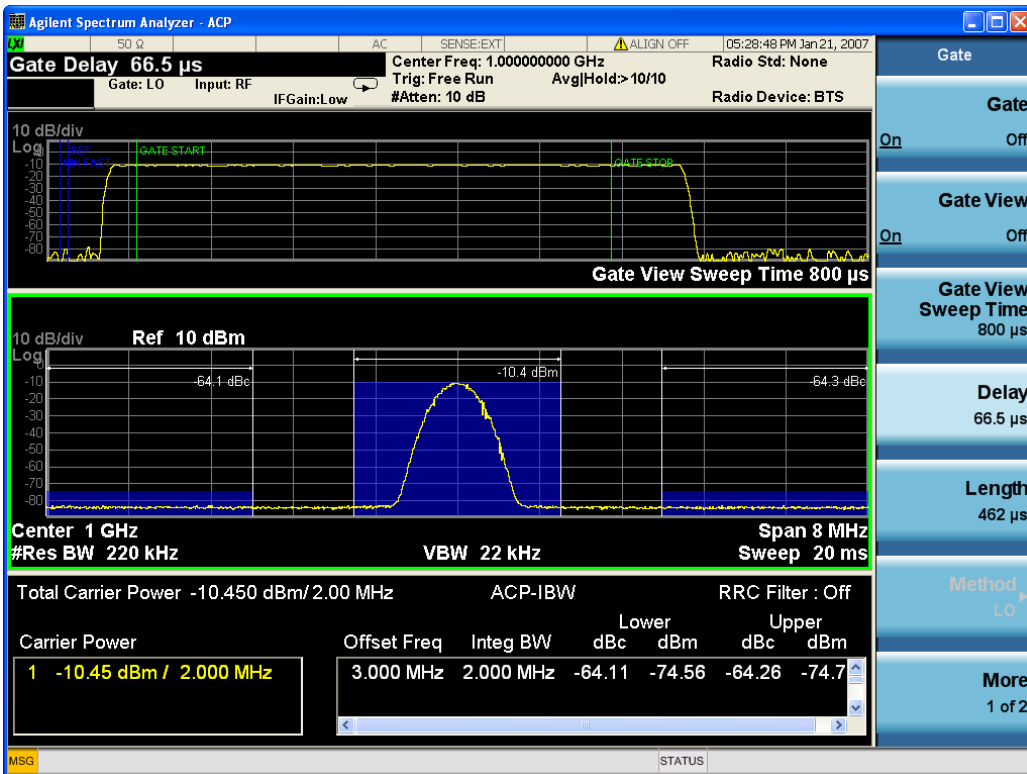

Turning Gate View off returns the analyzer to the Normal measurement view.

In the Swept SA, the normal measurement view is the single-window Swept SA view. When returning to this view, the Swept SA measurement returns to the Span it was in before entering **Gate View** (even if that is Zero Span).

The **Gate View** window is triggered from the Gate Source, with zero trigger delay. Also, when updating the **Gate View** window, the Gate itself must not operate. So it is internally shut off while the gate view window is being updated. For the Swept SA measurement, this means that the Gate is internally shut off whenever the gate view window is displayed. The measurement bar and softkeys continue to show the Trigger source for the main sweep window and give no indication that the Gate is shut off or that the Gate View window is triggered from the Gate Source.

When in **Gate View**, vertical lines are displayed in the Gate View window as follows:

- Green lines are displayed at the gate edges as follows: in Edge Gate, a line is shown for Delay and one for the end of the Gate period, defined by Length. You can adjust the position of the green lines by adjusting the gate length and the gate delay. These lines update in the Gate View window as the active function changes, even if the window is not being updated. In Gated FFT, their location is relative to the left edge of the screen.
- A blue line is displayed showing the delay reference, that is, the reference point for the Gate Delay within the Zero Span window. The blue line represents where (in time) the effective location of the gate start would be if the gate were programmed to zero delay.

-

Gate View Setup

Accesses a menu that enables you to setup parameters relevant to the Gate View

Key Path	Sweep/Control, Gate
Scope	Meas Global
Initial S/W Revision	A.10.00

Gate View Acquisition Time

Controls the acquisition time in the Gate View window. To provide an optimal view of the gate signal, the analyzer initializes Gate View Acq Time based on the current settings of Gate Delay and Gate Length.

Key Path	Sweep/Control, Gate, Gate View Setup
Remote Command	[:SENSe] :SWEep:EGATe:TIME <time> [:SENSe] :SWEep:EGATe:TIME?
Example	SWE:EGAT:TIME 500 ms
Dependencies	Gate View Acquisition Time is initialized: <ul style="list-style-type: none"> • On Preset (after initializing delay and length). • Every time the Gate Method is set/changed. <ol style="list-style-type: none"> 1. Compute the location of the "gate stop" line, which you know is at time $t = t_{min} + \text{GateDelay} +$

GateLength.	
Preset	519.3 μ s WiMAX OFDMA: 5 ms GSM/EDGE: 1 ms
State Saved	Saved in instrument state
Min	100 ns
Max	6000 s
Initial S/W Revision	Prior to A.02.00

Gate View Start Time

Controls the time at the left edge of the Gate View.

Key Path	Sweep/Control, Gate, Gate View Setup
Remote Command	[:SENSe] :SWEep:EGATe:VIEW:STARt <time> [:SENSe] :SWEep:EGATe:VIEW:STARt?
Example	SWE:EGAT:VIEW:STAR 10ms
Notes	Units of time are required or no units; otherwise an invalid suffix error message will be generated. See error -131.
Preset	0 ms
State Saved	Saved in instrument state
Min	0
Max	500 ms
Initial S/W Revision	A.10.00

Gate Delay

Controls the length of time from the time the gate condition goes True until the gate is turned on.

Key Path	Sweep/Control, Gate
Remote Command	[:SENSe] :SWEep:EGATe:DELay <time> [:SENSe] :SWEep:EGATe:DELay?
Example	SWE:EGAT:DELay 500ms SWE:EGAT:DELay?
Notes	Units of time are required or no units; otherwise an invalid suffix error message will be generated.
Preset	57.7 μ s WiMAX OFDMA: 71 μ s GSM/EDGE: 600 μ s

	WLAN: 500 us WLAN: 36 us
State Saved	Saved in instrument state
Min	0.0 us
Max	100 s
Backwards Compatibility SCPI	[:SENSe]:SWEep:TIME:GATE:DELay ESA compatibility
Initial S/W Revision	Prior to A.02.00

Gate Length

Controls the length of time that the gate is on after it opens.

Key Path	Sweep/Control, Gate
Remote Command	[:SENSe]:SWEep:EGATe:LENGth <time> [:SENSe]:SWEep:EGATe:LENGth?
Example	SWE:EGAT:LENG 1 SWE:EGAT:LENG?
Notes	Units of time are required or no units; otherwise an invalid suffix error message will be generated.
Preset	461.6 us WiMAX OFDMA: 50 us GSM/EDGE: 200 us WLAN: 1.54 ms WLAN: 32 us
State Saved	Saved in instrument state
Min	100 ns
Max	5 s
Backwards Compatibility SCPI	[:SENSe]:SWEep:TIME:GATE:LENGth ESA compatibility
Initial S/W Revision	Prior to A.02.00

Gate Source

The menus under the Gate Source key are the same as those under the Trigger key, with the exception that neither Free Run nor Video are available as Gate Source selections. However, a different SCPI command is used to select the Gate Source (see table below) because you may independently set the Gate Source and the Trigger Source.

Any changes to the settings in the setup menus under each Gate Source selection key (for example: Trigger Level, Trigger Delay, etc.) also affect the corresponding settings under the Trigger menu keys. The SCPI commands used for these are the same for Trigger and Gate, since there is only one setting which affects both Gate and Trigger. Example: to set the Trigger Level for External 1 you use the command :TRIG:EXT1:LEV regardless of whether you are using External 1 as a Trigger Source or a Gate Source.

Key Path	Sweep/Control, Gate
Remote Command	[:SENSe] :SWEep:EGATe:SOURce EXTernal1 EXTernal2 LINE FRAMe RFBurst [:SENSe] :SWEep:EGATe:SOURce?
Dependencies	In some models, there is no second External input. In these models, the External 2 key is blanked and the EXTernal2 parameter will generate a "Hardware missing; Not available for this model number" error.
Preset	EXTernal 1 GSM/EDGE, MSR: FRAMe LTETDD: EXTernal 1When Direction is Downlink, FRAMe when Direction is Uplink.
Initial S/W Revision	Prior to A.02.00
Modified at S/W Revision	A.03.00, A.14.00

Video (IF Envelope)

Pressing this key, when it is not selected, selects the video signal as the trigger. The Video trigger condition is met when the video signal (the filtered and detected version of the input signal, including both RBW and VBW filtering) crosses the video trigger level.

NOTE When the detector selected for all active traces is the average detector, the video signal for triggering does not include any VBW filtering.

The video trigger level is shown as a labeled line on the display. The line is displayed as long as video is the selected trigger source.

Pressing this key, when it is already selected, accesses the video trigger setup functions.

Key Path	Trigger
Example	TRIG:SOUR VID Swept SA measurement TRIG:<meas>:SOUR VID Measurements other than Swept SA
Notes	Log Plot and Spot Frequency measurements do not support Video Trigger
Dependencies	Video trigger is allowed in average detector mode.
State Saved	Saved in instrument state
Status Bits/OPC dependencies	The Status Operation Register bit 5 "Waiting for Trigger" is set at the same time as the Sweeping or Measuring bit is set. It is cleared when the trigger actually occurs (that is, after the trigger event occurs and all the applicable trigger criteria have been met). A corresponding pop-up message ("Waiting for trigger") is generated if no trigger signal appears after approximately 2 sec. This message goes away when a trigger signal appears.

Backwards Compatibility Notes	In the past, the Average detector was not available when Video triggering was on, and consequently, functions that set the detector to average (such as Marker Noise or Band/Intvl Power) were not available when the video trigger was on. Similarly, Video triggering was not available when the detector was Average. In the X-Series, these restrictions are removed.
Initial S/W Revision	Prior to A.02.00

Trigger Level

Sets a level for the video signal trigger. When the video signal crosses this level, with the chosen slope, the trigger occurs. This level is displayed with a horizontal line only if **Video** is the selected trigger source.

Key Path	Trigger, Video
Remote Command	:TRIGger[:SEquence]:VIDeo:LEVel <ampl> :TRIGger[:SEquence]:VIDeo:LEVel?
Example	TRIG:VID:LEV -40 dBm
Notes	<p>When sweep type = FFT, the video trigger uses the amplitude envelope in a bandwidth wider than the FFT width as a trigger source. This might often be useful, but does not have the same relationship between the displayed trace and the trigger level as in swept triggering.</p> <p>Amplitude Corrections are not taken into account by the Video Trig Level. For example, if you have given yourself effective gain with an amplitude correction factor, the Video Trigger will not fire until you have dropped the trigger line that far below the displayed signal level, rather than simply dropping it down to the displayed signal level.</p> <p>Note that other corrections, specifically External Gain and Ref Level Offset, modify the actual trace data as it is taken and therefore ARE taken into account by Trig Level.</p>
Couplings	This same level is used for the Video trigger source in the Trigger menu and for the Video selection in the Gate Source menu.
Preset	Set the Video Trigger Level -25 dBm on Preset. When the Video Trigger Level becomes the active function, if the value is off screen, set it to either the top or bottom of screen, depending on which direction off screen it was.
State Saved	Saved in instrument state
Min	-170 dBm
Max	+30 dBm
Default Unit	Depends on the current selected Y axis unit
Backwards Compatibility SCPI	:TRIGger[:SEquence]:IF:LEVel :TRIGger[:SEquence]:IF:LEVel?
Backwards Compatibility Notes	This alias is provided for backward compatibility with VSA/PSA comms apps.
Initial S/W Revision	Prior to A.02.00

Trig Slope

Controls the trigger polarity. It is set positive to trigger on a rising edge and negative to trigger on a falling edge.

Key Path	Trigger, Video
Remote Command	:TRIGger[:SEquence]:VIDeo:SLOPe POSitive NEGative :TRIGger[:SEquence]:VIDeo:SLOPe?
Example	TRIG:VID:SLOP NEG
Preset	POSitive
State Saved	Saved in instrument state
Backwards Compatibility SCPI	:TRIGger[:SEquence]:IF:SLOPe NEGative POSitive :TRIGger[:SEquence]:IF:SLOPe? For backward compatibility with VSA/PSA comms apps
Backwards Compatibility Notes	The legacy :TRIGger[:SEquence]:SLOPe command affects the slopes for the VID, LINE, EXT1, EXT2, and RFB triggers.
Initial S/W Revision	Prior to A.02.00

Remote Command	:TRIGger[:SEquence]:SLOPe POSitive NEGative :TRIGger[:SEquence]:SLOPe?
Example	TRIG:SLOP NEG
Preset	POSitive
State Saved	Saved in instrument state
Backwards Compatibility Notes	In ESA/PSA, the Trigger Slope was global to all triggers. In the X-Series, the slope can be set individually for each Trigger Source. For backward compatibility, the global SLOPe command updates all instances of trigger slope (VID, LINE, EXT1, EXT2, TV, RFB). The query returns the trigger slope setting of the currently selected trigger source.
Initial S/W Revision	Prior to A.02.00

External 1

Pressing this key, when it is not selected, selects an external input signal as the trigger. A new sweep/measurement will start when the external trigger condition is met using the external 1 input connector on the rear panel.

Pressing this key, when it is already selected, accesses the external 1 trigger setup menu.

Key Path	Trigger
Example	TRIG:SOUR EXT1 Swept SA measurement TRIG:<meas>:SOUR EXT1 Measurements other than Swept SA
Dependencies	Grayed out if in use by Point Trigger in the Source Setup menu. Forced to Free Run if already selected and Point Trigger is set to External 1.

State Saved	Saved in instrument state
Status Bits/OPC dependencies	The Status Operation Register bit 5 "Waiting for Trigger" is set at the same time as the Sweeping or Measuring bit is set. It is cleared when the trigger actually occurs (that is, after the trigger event occurs and all the applicable trigger criteria have been met). A corresponding pop-up message ("Waiting for trigger") is generated if no trigger signal appears after approximately 2 sec. This message goes away when a trigger signal appears.
Initial S/W Revision	Prior to A.02.00

Trigger Level

Sets the value where the external 1 trigger input will trigger a new sweep/measurement.

Key Path	Trigger, External 1
Remote Command	:TRIGger[:SEquence]:EXTernal:LEVel <level> :TRIGger[:SEquence]:EXTernal:LEVel?
Example	TRIG:EXT1:LEV 0.4 V
Couplings	This same level is used for the Ext1 trigger source in the Trigger menu, for the Ext1 selection in the Periodic Timer sync source (in the Trigger menu and in the Gate Source menu), and also for the Ext1 selection in the Gate Source menu.
Preset	1.2 V
State Saved	Saved in instrument state
Min	-3.5V
Max	3.5V
Default Unit	V
Backwards Compatibility SCPI	:TRIGger[:SEquence]:EXTernal:LEVel For backward compatibility, the parameter EXTernal is mapped to EXTernal1
Backwards Compatibility SCPI	:TRIGger[:SEquence]:FRAMe:EXTernal1:LEVel
Initial S/W Revision	Prior to A.02.00

Trig Slope

Controls the trigger polarity. It is set positive to trigger on a rising edge and negative to trigger on a falling edge.

Key Path	Trigger, External 1
Remote Command	:TRIGger[:SEquence]:EXTernal:SLOPe POSitive NEGative :TRIGger[:SEquence]:EXTernal:SLOPe?

Example	TRIG:EXT1:SLOP NEG
Couplings	This same slope is used in the Ext1 selection for the trigger source in the Trigger menu and for the period timer sync source (in the Trigger menu and in the Gate Source menu).
Preset	POSitive
State Saved	Saved in instrument state
Backwards Compatibility SCPI	:TRIGger[:SEQuence]:EXTernal:SLOPe For backward compatibility, the parameter EXTernal is mapped to EXTernal1
Backwards Compatibility SCPI	:TRIGger[:SEQuence]:FRAMe:EXTernal1:SLOPe
Backwards Compatibility Notes	The legacy :TRIGger[:SEQuence]:SLOPe command affects the slopes for the VID, LINE, EXT1, EXT2, and RFB triggers.
Initial S/W Revision	Prior to A.02.00

Zero Span Delay Comp On/Off

In zero span, there is a natural delay in the signal path, which comes from the RBW filter. This is usually desirable, as it allows you to trigger on events and also see those events, because the signal is delayed from the trigger event. However, in some cases it is desirable to eliminate this delay, so that trigger events line up exactly with the zero time point in zero span. You can use the Zero Span Delay Comp On/Off feature to enable or disable zero span delay compensation.

Key Path	Trigger, External 1
Remote Command	:TRIGger[:SEQuence]:EXTernal1:DELAy:COMPensation OFF ON 0 1 :TRIGger[:SEQuence]:EXTernal1:DELAy:COMPensation?
Example	TRIG:EXT1:DEL:COMP ON
Dependencies	No effect except in zero-span, but not locked out in nonzero spans. Blanked in modes that do not support zero-span measurements. If the SCPI command is sent when the key is blanked, an error is returned: -221, "Settings conflict; Feature not supported for this measurement" In analyzers shipping N9060A, this feature requires N9060A-7FP.
Preset	OFF
State Saved	Saved in instrument state
Initial S/W Revision	A.11.00

External 2

Pressing this key, when it is not selected, selects an external input signal as the trigger. A new sweep/measurement will start when the external trigger condition is met using the external 2 input connector. The external trigger 2 input connector is on the rear panel.

Pressing this key, when it is already selected, accesses the external 2 trigger setup menu.

Key Path	Trigger
Example	TRIG:SOUR EXT2 Swept SA measurement TRIG:<meas>:SOUR EXT2 Measurements other than Swept SA
Dependencies	In some models, there is no second External input. In these models, the External 2 key is blanked and the EXTERNAL2 parameter will generate a "Hardware missing; Not available for this model number" message. Grayed out if in use by Point Trigger in the Source Setup menu. Forced to Free Run if already selected and Point Trigger is set to External 2.
State Saved	Saved in instrument state
Status Bits/OPC dependencies	The Status Operation Register bit 5 "Waiting for Trigger" is set at the same time as the Sweeping or Measuring bit is set. It is cleared when the trigger actually occurs (that is, after the trigger event occurs and all the applicable trigger criteria have been met). A corresponding pop-up message ("Waiting for trigger") is generated if no trigger signal appears after approximately 2 sec. This message goes away when a trigger signal appears.
Initial S/W Revision	Prior to A.02.00
Modified at S/W Revision	A.03.00

Trigger Level

Sets the value where the external 2 trigger input will trigger a new sweep/measurement.

Key Path	Trigger, External 2
Remote Command	:TRIGger[:SEquence]:EXTernal2:LEVel :TRIGger[:SEquence]:EXTernal2:LEVel?
Example	TRIG:EXT2:LEV 1.1 V
Couplings	This same level is used for the Ext2 trigger source in the Trigger menu, for the Ext2 selection in the Periodic Timer sync source (in the Trigger menu and in the Gate Source menu), and also for the Ext2 selection in the Gate Source menu.
Preset	1.2 V
State Saved	Saved in instrument state
Min	-3.5V
Max	3.5V
Default Unit	V
Backwards Compatibility SCPI	:TRIGger[:SEquence]:FRAME:EXTernal2:LEVel
Initial S/W Revision	Prior to A.02.00

Trig Slope

Controls the trigger polarity. It is set positive to trigger on a rising edge and negative to trigger on a falling edge.

Key Path	Trigger, External 2
Remote Command	:TRIGger[:SEquence]:EXTernal2:SLOPe POSitive NEGative :TRIGger[:SEquence]:EXTernal2:SLOPe?
Example	TRIG:EXT2:SLOP NEG
Couplings	This same slope is used in the Ext2 selection for the trigger source in the Trigger menu and for the period timer sync source (in the Trigger menu and in the Gate Source menu).
Preset	POSitive
State Saved	Saved in instrument state
Backwards Compatibility SCPI	:TRIGger[:SEquence]:FRAMe:EXTernal2:SLOPe
Backwards Compatibility Notes	The legacy :TRIGger[:SEquence]:SLOPe command affects the slopes for the VID, LINE, EXT1, EXT2, and RFB triggers.
Initial S/W Revision	Prior to A.02.00

Zero Span Delay Comp On/Off

In zero span, there is a natural delay in the signal path, which comes from the RBW filter. This is usually desirable, as it allows you to trigger on events and also see those events, because the signal is delayed from the trigger event. However, in some cases it is desirable to eliminate this delay, so that trigger events line up exactly with the zero time point in zero span. You can use the Zero Span Delay Comp On/Off feature to enable or disable zero span delay compensation.

Key Path	Trigger, External 2
Remote Command	:TRIGger[:SEquence]:EXTernal2:DELAy:COMPensation OFF ON 0 1 :TRIGger[:SEquence]:EXTernal2:DELAy:COMPensation?
Example	TRIG:EXT2:DEL:COMP ON
Dependencies	No effect except in zero-span, but not locked out in nonzero spans. Blanked in modes that do not support zero-span measurements. If the SCPI command is sent when the key is blanked, an error is returned: -221, "Settings conflict; Feature not supported for this measurement" In analyzers shipping N9060A, this feature requires N9060A-7FP.
Preset	OFF
State Saved	Saved in instrument state
Initial S/W Revision	A.11.00

RF Burst

Pressing this key, when it is not selected, selects the RF Burst as the trigger. A new sweep/measurement will start when an RF burst envelope signal is identified from the signal at the RF Input connector. Pressing this key, when it is already selected, accesses the RF Burst trigger setup menu.

In some models, a variety of burst trigger circuitry is available, resulting in various available burst trigger bandwidths. The analyzer automatically chooses the appropriate trigger path based on the hardware configuration and other settings of the analyzer.

Key Path	Trigger
Example	TRIG:SOUR RFB Swept SA measurement TRIG:< meas>:SOUR RFB Measurements other than Swept SA
State Saved	Saved in instrument state
Status Bits/OPC dependencies	The Status Operation Register bit 5 "Waiting for Trigger" is set at the same time as the Sweeping or Measuring bit is set. It is cleared when the trigger actually occurs (that is, after the trigger event occurs and all the applicable trigger criteria have been met). A corresponding pop-up message ("Waiting for trigger") is generated if no trigger signal appears after approximately 2 sec. This message goes away when a trigger signal appears.
Backwards Compatibility Notes	The legacy command: :TRIGger[:SEQuence]:RFBurst:FSElectivity[:STATe] OFF ON 0 1 is not supported in the X-Series, as the hardware to do Frequency Selective burst triggers does not exist in X-Series.
Initial S/W Revision	Prior to A.02.00
Modified at S/W Revision	A.04.00

Absolute Trigger Level

Sets the absolute trigger level for the RF burst envelope.

When using the External Mixing path, the Absolute Trigger Level is uncalibrated because the factory default was set to accommodate the expected IF levels for the RF path.

Key Path	Trigger, RF Burst
Scope	Meas Global
Remote Command	:TRIGger[:SEQuence]:RFBurst:LEVel:ABSolute <ampl> :TRIGger[:SEQuence]:RFBurst:LEVel:ABSolute?
Example	TRIG:RFB:LEV:ABS 10 dBm sets the trigger level of the RF burst envelope signal to the absolute level of 10 dBm
Notes	Sending this command does not switch the setting from relative to absolute; to switch it you need to send the :TRIGger[:SEQuence]:RFBurst:LEVel:TYPE command, below. Amplitude Corrections are not taken into account by the Absolute Trigger Level. For example, if you have given yourself effective gain with an amplitude correction factor, the Absolute Trigger will not fire until you have set the trigger level that far below the displayed signal level, rather than simply to

	the displayed signal level. This is only true for Amplitude Corrections, not External Gain or Ref Level Offset functions. If mode is Bluetooth, the default value is -50 dBm.
Couplings	This same level is used for the RF Burst trigger source in the Trigger menu, for the RF Burst selection in the Periodic Timer sync source (in the Trigger menu and in the Gate Source menu), and also for the RF Burst selection in the Gate Source menu
Preset	-20 dBm
State Saved	Saved in instrument state
Min	-200 dBm
Max	100 dBm
Default Unit	depends on the current selected Y-Axis unit
Backwards Compatibility SCPI	:TRIGger[:SEquence]:FRAMe:RFBurst:LEVel:ABSolute
Initial S/W Revision	Prior to A.02.00
Modified at S/W Revision	A.04.00

Key Path	Trigger, RF Burst
Remote Command	:TRIGger[:SEquence]:RFBurst:LEVel:TYPE ABSolute RELative :TRIGger[:SEquence]:RFBurst:LEVel:TYPE?
Example	TRIG:RFB:LEV:TYPE REL sets the trigger level type of the RF burst trigger to Relative.
Preset	ABSolute
State Saved	Saved in instrument state
Initial S/W Revision	Prior to A.02.00
Modified at S/W Revision	A.04.00

Relative Trigger Level

Sets the relative trigger level for the RF burst envelope.

In some models, the relative burst trigger function is implemented in hardware. In other models, without the advanced triggering hardware required, the relative burst trigger function is implemented in software in some measurements, and is unavailable in other measurements.

When implemented in software, the relative RF Burst trigger function is implemented as follows:

1. The measurement starts with the absolute RF Burst trigger setting. If it cannot get a trigger with that level, auto trigger fires and the acquisition starts anyway. After the acquisition, the measurement searches for the peak in the acquired waveform and saves it.

2. Now, in the next cycle of the measurement, the measurement determines a new absolute RF Burst level based on the peak value from the first measurement and the Relative RF Burst Trigger Level (always 0 or negative dB) set by the user. The following formula is used:
 3. absolute RF Burst level = peak level of the previous acquisition + relative RF Burst level
 4. If the new absolute RF Burst level differs from the previous by more than 0.5 dB, the new level is sent to the hardware; otherwise it is not updated (to avoid slowing down the acquisition)
- Steps 2 and 3 repeat for subsequent measurements.

Key Path	Trigger, RF Burst
Scope	Meas Global
Remote Command	:TRIGger[:SEquence]:RFBurst:LEVel:RELative <rel_ampl> :TRIGger[:SEquence]:RFBurst:LEVel:RELative?
Example	TRIG:RFB:LEV:REL -10 dB sets the trigger level of the RF burst envelope signal to the relative level of -10 dB
Notes	Sending this command does not switch the setting from absolute to relative; to switch it you need to send the :TRIGger[:SEquence]:RFBurst:LEVel:TYPE command, above. The relative trigger level is not available in some measurements. In those measurements the RELative parameter, and the :TRIGger[:SEquence]:RFBurst:LEVel:TYPE command (above), will generate an error if sent.
Dependencies	This key is grayed out and Absolute Trigger Level selected if the required hardware is not present in your analyzer and the current measurement does not support Relative triggering.
Preset	-6 dB GSM: -25 dB
State Saved	Saved in instrument state
Min	-45 dB
Max	0 dB
Default Unit	dB or dBc
Backwards Compatibility SCPI	:TRIGger[:SEquence]:RFBurst:LEVel This legacy command is aliased to :TRIGger[:SEquence]:RFBurst:LEVel:RELative because the PSA had ONLY relative burst triggering
Initial S/W Revision	Prior to A.02.00
Modified at S/W Revision	A.04.00

Trigger Slope

It is set positive to trigger on a rising edge and negative to trigger on a falling edge.

Key Path	Trigger, RF Burst
Remote Command	:TRIGger[:SEquence]:RFBurst:SLOPe POSitive NEGative :TRIGger[:SEquence]:RFBurst:SLOPe?

Example	TRIG:RFB:SLOP NEG
Couplings	This same slope is used in the RF Burst selection for the trigger source in the Trigger menu and for the period timer sync source (in the Trigger menu and in the Gate Source menu).
Preset	POSitive
State Saved	Saved in instrument state
Backwards Compatibility SCPI	:TRIGger[:SEQuence]:FRAMe:RFBurst:SLOPe
Backwards Compatibility Notes	The legacy :TRIGger[:SEQuence]:SLOPe command affects the slopes for the VID, LINE, EXT1, EXT2, and RFB triggers.
Initial S/W Revision	Prior to A.02.00

Periodic Timer (Frame Trigger)

Pressing this key, when it is not selected, selects the internal periodic timer signal as the trigger. Triggering occurrences are set by the **Period** parameter, which is modified by the **Sync Source** and **Offset**. Pressing this key, when it is already selected, accesses the periodic timer trigger setup functions.

If you do not have a sync source selected (it is Off), then the internal timer will not be synchronized with any external timing events.

Key Path	Trigger
Example	TRIG:SOUR FRAM Swept SA measurement TRIG:<meas>:SOUR FRAM Measurements other than Swept SA
State Saved	Saved in instrument state
Readback	[Sync: <value of Sync Source>], for example, [Sync: External 1]
Status Bits/OPC dependencies	The Status Operation Register bit 5 "Waiting for Trigger" is set at the same time as the Sweeping or Measuring bit is set. It is cleared when the trigger actually occurs (that is, after the trigger event occurs and all the applicable trigger criteria have been met). A corresponding pop-up message ("Waiting for trigger") is generated if no trigger signal appears after approximately 2 sec. This message goes away when a trigger signal appears.
Initial S/W Revision	Prior to A.02.00

Periodic Timer Triggering:

This feature selects the internal periodic timer signal as the trigger. Trigger occurrences are set by the **Periodic Timer** parameter, which is modified by the **Sync Source** and **Offset**.

The figure below shows the action of the periodic timer trigger. Before reviewing the figure, we'll explain some uses for the periodic trigger.

A common application is measuring periodic burst RF signals for which a trigger signal is not easily available. For example, we might be measuring a TDMA radio which bursts every 20 ms. Let's assume that the 20 ms period is very consistent. Let's also assume that we do not have an external trigger source

available that is synchronized with the period, and that the signal-to-noise ratio of the signal is not high enough to provide a clean RF burst trigger at all of the analysis frequencies. For example, we might want to measure spurious transmissions at an offset from the carrier that is larger than the bandwidth of the RF burst trigger. In this application, we can set the Periodic Timer to a 20.00 ms period and adjust the offset from that timer to position our trigger just where we want it. If we find that the 20.00 ms is not exactly right, we can adjust the period slightly to minimize the drift between the period timer and the signal to be measured.

A second way to use this feature would be to use **Sync Source** temporarily, instead of **Offset**. In this case, we might tune to the signal in a narrow span and use the RF Burst trigger to synchronize the periodic timer. Then we would turn the sync source off so that it would not miss-trigger. Miss-triggering can occur when we are tuned so far away from the RF burst trigger that it is no longer reliable.

A third example would be to synchronize to a signal that has a reference time element of much longer period than the period of interest. In some CDMA applications, it is useful to look at signals with a short periodicity, by synchronizing that periodicity to the "even-second clock" edge that happens every two seconds. Thus, we could connect the even-second clock trigger to Ext1 and use then Ext1 as the sync source for the periodic timer.

The figure below illustrates this third example. The top trace represents the even-second clock. It causes the periodic timer to synchronize with the leading edge shown. The analyzer trigger occurs at a time delayed by the accumulated offset from the period trigger event. The periodic timer continues to run, and triggers continue to occur, with a periodicity determined by the analyzer time base. The timer output (labeled "late event") will drift away from its ideal time due to imperfect matching between the time base of the signal being measured and the time base of the analyzer, and also because of imperfect setting of the period parameter. But the synchronization is restored on the next even-second clock event. ("Accumulated offset" is described in the in the **Offset** function section.)

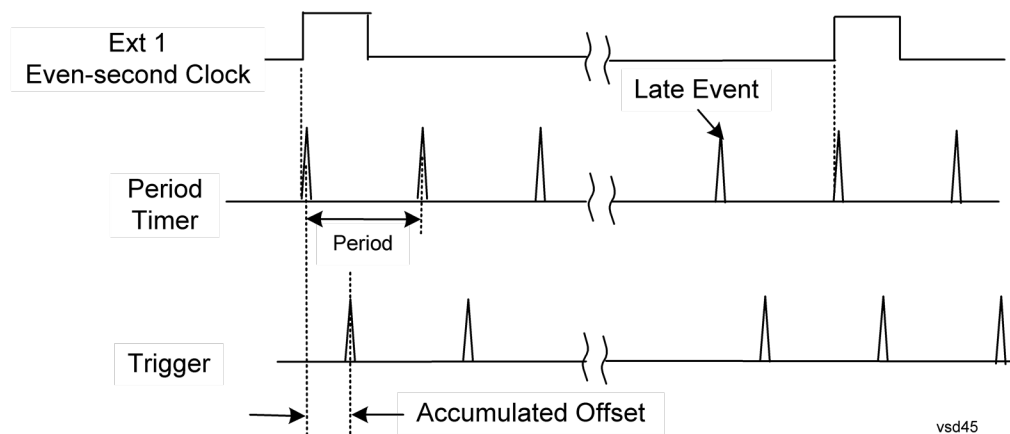

Period

Sets the period of the internal periodic timer clock. For digital communications signals, this is usually set to the frame period of your current input signal. In the case that sync source is not set to OFF, and the external sync source rate is changed for some reason, the periodic timer is synchronized at the every external synchronization pulse by resetting the internal state of the timer circuit.

Key Path	Trigger, Periodic Timer
Remote Command	:TRIGger[:SEquence]:FRAME:PERiod <time>

	:TRIGger[:SEquence]:FRAMe:PERiod?
Example	TRIG:FRAM:PER 100 ms
Dependencies	The invalid data indicator turns on when the period is changed, until the next sweep/measurement completes.
Couplings	The same period is used in the Gate Source selection of the period timer.
Preset	20 ms GSM: 4.615383
State Saved	Saved in instrument state
Min	100.000 ns
Max	559.0000 ms
Default Unit	S
Initial S/W Revision	Prior to A.02.00

Offset

Adjusts the accumulated offset between the periodic timer events and the trigger event. Adjusting the accumulated offset is different than setting an offset, and requires explanation.

The periodic timer is usually not synchronized with any external events, so the timing of its output events has no absolute meaning. Since the timing relative to external events (RF signals) is important, you need to be able to adjust (offset) it. However, you have no direct way to see when the periodic timer events occur. All that you can see is the trigger timing. When you want to adjust the trigger timing, you will be changing the internal offset between the periodic timer events and the trigger event. Because the absolute value of that internal offset is unknown, we will just call that the accumulated offset. Whenever the Offset parameter is changed, you are changing that accumulated offset. You can reset the displayed offset using Reset Offset Display. Changing the display does not change the value of the accumulated offset, and you can still make additional changes to accumulated offset.

To avoid ambiguity, we define that an increase in the "offset" parameter, either from the knob or the SCPI adjust command, serves to delay the timing of the trigger event.

Key Path	Trigger, Periodic Timer
Remote Command	:TRIGger[:SEquence]:FRAMe:OFFSet <time> :TRIGger[:SEquence]:FRAMe:OFFSet?
Example	TRIG:FRAM:OFFS 1.2 ms
Notes	The front panel interface (for example, the knob), and this command, adjust the accumulated offset, which is shown on the active function display. However, the actual amount sent to the hardware each time the offset is updated is the delta value, that is, the current accumulated offset value minus the previous accumulated offset value. Note that the accumulated offset value is essentially arbitrary; it represents the accumulated offset from the last time the offset was zeroed (with the Reset Offset Display key). Note that this command does not change the period of the trigger waveform. Note also that Offset is used only when the sync source is set to OFF, otherwise delay is used, see section "Trig Delay" on page 280.

	An increase in the "offset" parameter, either from the knob or the SCPI adjust command, serves to delay the timing of the trigger event.
Notes	When the SCPI command is sent the value shown on the key (and the Active Function, if this happens to be the active function) is updated with the new value. However, the actual amount sent to the hardware is the delta value, that is, the current accumulated offset value minus the previous accumulated offset value. The SCPI query simply returns the value currently showing on the key.
Dependencies	The invalid data indicator turns on when the offset is changed, until the next sweep/measurement completes.
Couplings	The same offset is used in the Gate Source selection of the period timer.
Preset	0 s
State Saved	Saved in instrument state
Min	-10.000 s
Max	10.000 s
Default Unit	S
Initial S/W Revision	Prior to A.02.00

Offset Adjust (Remote Command Only)

This remote command does not work at all like the related front panel keys. This command lets you advance the phase of the frame trigger by the amount you specify.

It does not change the period of the trigger waveform. If the command is sent multiple times, it advances the phase of the frame trigger an additional amount each time it is sent. Negative numbers are permitted.

Remote Command	:TRIGger[:SEquence]:FRAMe:ADJust <time>
Example	TRIG:FRAM:ADJ 1.2 ms
Notes	Note also that Offset is used only when the sync source is set to OFF, otherwise delay is used, see section " Trig Delay " on page 280 An increase in the "offset" parameter, either from the knob or the SCPI adjust command, serves to delay the timing of the trigger event.
Notes	The front panel interface (for example, the knob) and the :TRIG:FRAM:OFFS command adjust the accumulated offset, which is shown on the active function display. However, the actual amount sent to the hardware is the delta value, that is, the current offset value minus the previous offset value. When the SCPI command is sent the value shown on the key (and the Active Function, if this happens to be the active function) is updated by increasing it (or decreasing it if the value sent is negative) by the amount specified in the SCPI command. This is a "command only" SCPI command, with no query.
Dependencies	The invalid data indicator turns on when the offset is changed, until the next sweep/measurement completes.
Couplings	The same offset is used in the Gate Source selection of the period timer.
Preset	0 s

State Saved	Saved in instrument state
Min	-10.000 s
Max	10.000 s
Default Unit	S
Initial S/W Revision	Prior to A.02.00

Reset Offset Display

Resets the value of the periodic trigger offset display setting to 0.0 seconds. The current displayed trigger location may include an offset value defined with the Offset key. Pressing this key redefines the currently displayed trigger location as the new trigger point that is 0.0 s offset. The Offset key can then be used to add offset relative to this new timing.

Key Path	Trigger, Periodic Timer
Remote Command	:TRIGger[:SEquence]:FRAMe:OFFSet:DISPlay:RESet
Example	TRIG:FRAM:OFFS:DISP:RES
Initial S/W Revision	Prior to A.02.00

Sync Source

Selects a signal source for you to synchronize your periodic timer trigger to, otherwise you are triggering at some arbitrary location in the frame. Synchronization reduces the precision requirements on the setting of the period.

For convenience you may adjust the level and slope of the selected sync source in a conditional branch setup menu accessed from the Sync Source menu. Note that these settings match those in the **Trigger** and **Gate Source** menus; that is, each trigger source has only one value of level and slope, regardless of which menu it is accessed from.

Key Path	Trigger, Periodic Timer
Remote Command	:TRIGger[:SEquence]:FRAMe:SYNC EXTernal1 EXTernal2 RFBurst OFF :TRIGger[:SEquence]:FRAMe:SYNC?
Example	TRIG:FRAM:SYNC EXT2
Dependencies	In some models, there is no second External input. In these models, the External 2 key is blanked and the EXTernal2 parameter will generate a "Hardware missing; Not available for this model number" message.
Preset	Off GSM/EDGE, MSR,LTE,LTETDD: RFBurst
State Saved	Saved in instrument state
Readback	The current setting is read back to this key and it is also Readback to the previous Periodic Timer trigger key.

Backwards Compatibility SCPI	:TRIGger[:SEquence]:FRAMe:SYNC EXTernal
Initial S/W Revision	Prior to A.02.00
Modified at S/W Revision	A.03.00, A.14.00

Off

Turns off the sync source for your periodic trigger. With the sync source off, the timing will drift unless the signal source frequency is locked to the analyzer frequency reference.

Key Path	Trigger, Periodic Timer, Sync Source
Example	TRIG:FRAM:SYNC OFF
Readback	Off
Initial S/W Revision	Prior to A.02.00

External 1

Pressing this key, when it is not selected, selects an external input signal as the trigger. A new sweep/measurement will start when the external trigger condition is met using the external 1 input connector on the rear panel.

Pressing this key, when it is already selected, accesses the external 1 trigger setup menu.

Key Path	Trigger
Example	TRIG:SOUR EXT1 Swept SA measurement TRIG:<meas>:SOUR EXT1 Measurements other than Swept SA
Dependencies	Grayed out if in use by Point Trigger in the Source Setup menu. Forced to Free Run if already selected and Point Trigger is set to External 1.
State Saved	Saved in instrument state
Status Bits/OPC dependencies	The Status Operation Register bit 5 "Waiting for Trigger" is set at the same time as the Sweeping or Measuring bit is set. It is cleared when the trigger actually occurs (that is, after the trigger event occurs and all the applicable trigger criteria have been met). A corresponding pop-up message ("Waiting for trigger") is generated if no trigger signal appears after approximately 2 sec. This message goes away when a trigger signal appears.
Initial S/W Revision	Prior to A.02.00

Trigger Level

Sets the value where the external 1 trigger input will trigger a new sweep/measurement.

Key Path	Trigger, External 1
Remote Command	:TRIGger[:SEquence]:EXTernal1:LEVel <level> :TRIGger[:SEquence]:EXTernal1:LEVel?
Example	TRIG:EXT1:LEV 0.4 V
Couplings	This same level is used for the Ext1 trigger source in the Trigger menu, for the Ext1 selection in the Periodic Timer sync source (in the Trigger menu and in the Gate Source menu), and also for the Ext1 selection in the Gate Source menu.
Preset	1.2 V
State Saved	Saved in instrument state
Min	-3.5V
Max	3.5V
Default Unit	V
Backwards Compatibility SCPI	:TRIGger[:SEquence]:EXTernal:LEVel For backward compatibility, the parameter EXTernal is mapped to EXTernal1
Backwards Compatibility SCPI	:TRIGger[:SEquence]:FRAMe:EXTernal1:LEVel
Initial S/W Revision	Prior to A.02.00

Trig Slope

Controls the trigger polarity. It is set positive to trigger on a rising edge and negative to trigger on a falling edge.

Key Path	Trigger, External 1
Remote Command	:TRIGger[:SEquence]:EXTernal1:SLOPe POSitive NEGative :TRIGger[:SEquence]:EXTernal1:SLOPe?
Example	TRIG:EXT1:SLOP NEG
Couplings	This same slope is used in the Ext1 selection for the trigger source in the Trigger menu and for the period timer sync source (in the Trigger menu and in the Gate Source menu).
Preset	POSitive
State Saved	Saved in instrument state
Backwards Compatibility SCPI	:TRIGger[:SEquence]:EXTernal:SLOPe For backward compatibility, the parameter EXTernal is mapped to EXTernal1
Backwards Compatibility SCPI	:TRIGger[:SEquence]:FRAMe:EXTernal1:SLOPe
Backwards Compatibility Notes	The legacy :TRIGger[:SEquence]:SLOPe command affects the slopes for the VID, LINE, EXT1, EXT2, and RFB triggers.
Initial S/W Revision	Prior to A.02.00

External 2

Pressing this key, when it is not selected, selects an external input signal as the trigger. A new sweep/measurement will start when the external trigger condition is met using the external 2 input connector. The external trigger 2 input connector is on the rear panel.

Pressing this key, when it is already selected, accesses the external 2 trigger setup menu.

Key Path	Trigger
Example	TRIG:SOUR EXT2 Swept SA measurement TRIG:<meas>:SOUR EXT2 Measurements other than Swept SA
Dependencies	In some models, there is no second External input. In these models, the External 2 key is blanked and the EXTernal2 parameter will generate a "Hardware missing; Not available for this model number" message. Grayed out if in use by Point Trigger in the Source Setup menu. Forced to Free Run if already selected and Point Trigger is set to External 2.
State Saved	Saved in instrument state
Status Bits/OPC dependencies	The Status Operation Register bit 5 "Waiting for Trigger" is set at the same time as the Sweeping or Measuring bit is set. It is cleared when the trigger actually occurs (that is, after the trigger event occurs and all the applicable trigger criteria have been met). A corresponding pop-up message ("Waiting for trigger") is generated if no trigger signal appears after approximately 2 sec. This message goes away when a trigger signal appears.
Initial S/W Revision	Prior to A.02.00
Modified at S/W Revision	A.03.00

Trigger Level

Sets the value where the external 2 trigger input will trigger a new sweep/measurement.

Key Path	Trigger, External 2
Remote Command	:TRIGger[:SEquence]:EXTernal2:LEVel :TRIGger[:SEquence]:EXTernal2:LEVel?
Example	TRIG:EXT2:LEV 1.1 V
Couplings	This same level is used for the Ext2 trigger source in the Trigger menu, for the Ext2 selection in the Periodic Timer sync source (in the Trigger menu and in the Gate Source menu), and also for the Ext2 selection in the Gate Source menu.
Preset	1.2 V
State Saved	Saved in instrument state
Min	-3.5V
Max	

	3.5V
Default Unit	V
Backwards Compatibility SCPI	:TRIGger[:SEquence]:FRAMe:EXTernal2:LEVel
Initial S/W Revision	Prior to A.02.00

Trig Slope

Controls the trigger polarity. It is set positive to trigger on a rising edge and negative to trigger on a falling edge.

Key Path	Trigger, External 2
Remote Command	:TRIGger[:SEquence]:EXTernal2:SLOPe POSitive NEGative :TRIGger[:SEquence]:EXTernal2:SLOPe?
Example	TRIG:EXT2:SLOP NEG
Couplings	This same slope is used in the Ext2 selection for the trigger source in the Trigger menu and for the period timer sync source (in the Trigger menu and in the Gate Source menu).
Preset	POSitive
State Saved	Saved in instrument state
Backwards Compatibility SCPI	:TRIGger[:SEquence]:FRAMe:EXTernal2:SLOPe
Backwards Compatibility Notes	The legacy :TRIGger[:SEquence]:SLOPe command affects the slopes for the VID, LINE, EXT1, EXT2, and RFB triggers.
Initial S/W Revision	Prior to A.02.00

RF Burst

Pressing this key, when it is not selected, selects the RF Burst as the trigger. A new sweep/measurement will start when an RF burst envelope signal is identified from the signal at the RF Input connector. Pressing this key, when it is already selected, accesses the RF Burst trigger setup menu.

In some models, a variety of burst trigger circuitry is available, resulting in various available burst trigger bandwidths. The analyzer automatically chooses the appropriate trigger path based on the hardware configuration and other settings of the analyzer.

Key Path	Trigger
Example	TRIG:SOUR RFB Swept SA measurement TRIG:<meas>:SOUR RFB Measurements other than Swept SA
State Saved	Saved in instrument state
Status Bits/OPC dependencies	The Status Operation Register bit 5 "Waiting for Trigger" is set at the same time as the Sweeping or Measuring bit is set. It is cleared when the trigger actually occurs (that is, after the trigger event)

	occurs and all the applicable trigger criteria have been met). A corresponding pop-up message ("Waiting for trigger") is generated if no trigger signal appears after approximately 2 sec. This message goes away when a trigger signal appears.
Backwards Compatibility Notes	The legacy command: :TRIGger[:SEquence]:RFBurst:FSElectivity[:STATe] OFF ON 0 1 is not supported in the X-Series, as the hardware to do Frequency Selective burst triggers does not exist in X-Series.
Initial S/W Revision	Prior to A.02.00
Modified at S/W Revision	A.04.00

Absolute Trigger Level

Sets the absolute trigger level for the RF burst envelope.

When using the External Mixing path, the Absolute Trigger Level is uncalibrated because the factory default was set to accommodate the expected IF levels for the RF path.

Key Path	Trigger, RF Burst
Scope	Meas Global
Remote Command	:TRIGger[:SEquence]:RFBurst:LEVel:ABSolute <ampl> :TRIGger[:SEquence]:RFBurst:LEVel:ABSolute?
Example	TRIG:RFB:LEV:ABS 10 dBm sets the trigger level of the RF burst envelope signal to the absolute level of 10 dBm
Notes	Sending this command does not switch the setting from relative to absolute; to switch it you need to send the :TRIGger[:SEquence]:RFBurst:LEVel:TYPE command, below. Amplitude Corrections are not taken into account by the Absolute Trigger Level. For example, if you have given yourself effective gain with an amplitude correction factor, the Absolute Trigger will not fire until you have set the trigger level that far below the displayed signal level, rather than simply to the displayed signal level. This is only true for Amplitude Corrections, not External Gain or Ref Level Offset functions. If mode is Bluetooth, the default value is -50 dBm.
Couplings	This same level is used for the RF Burst trigger source in the Trigger menu, for the RF Burst selection in the Periodic Timer sync source (in the Trigger menu and in the Gate Source menu), and also for the RF Burst selection in the Gate Source menu
Preset	-20 dBm
State Saved	Saved in instrument state
Min	-200 dBm
Max	100 dBm
Default Unit	depends on the current selected Y-Axis unit
Backwards Compatibility SCPI	:TRIGger[:SEquence]:FRAME:RFBurst:LEVel:ABSolute
Initial S/W Revision	Prior to A.02.00
Modified at S/W Revision	A.04.00

Key Path	Trigger, RF Burst
Remote Command	:TRIGger[:SEquence]:RFBurst:LEVel:TYPE ABSolute RELative :TRIGger[:SEquence]:RFBurst:LEVel:TYPE?
Example	TRIG:RFB:LEV:TYPE REL sets the trigger level type of the RF burst trigger to Relative.
Preset	ABSolute
State Saved	Saved in instrument state
Initial S/W Revision	Prior to A.02.00
Modified at S/W Revision	A.04.00

Trigger Slope

It is set positive to trigger on a rising edge and negative to trigger on a falling edge.

Key Path	Trigger, RF Burst
Remote Command	:TRIGger[:SEquence]:RFBurst:SLOPe POSitive NEGative :TRIGger[:SEquence]:RFBurst:SLOPe?
Example	TRIG:RFB:SLOP NEG
Couplings	This same slope is used in the RF Burst selection for the trigger source in the Trigger menu and for the period timer sync source (in the Trigger menu and in the Gate Source menu).
Preset	POSitive
State Saved	Saved in instrument state
Backwards Compatibility SCPI	:TRIGger[:SEquence]:FRAMe:RFBurst:SLOPe
Backwards Compatibility Notes	The legacy :TRIGger[:SEquence]:SLOPe command affects the slopes for the VID, LINE, EXT1, EXT2, and RFB triggers.
Initial S/W Revision	Prior to A.02.00

Sync Holdoff

Sync Holdoff specifies the duration that the sync source signal must be kept false before the transition to true to be recognized as the sync timing. The periodic timer phase is aligned when the sync source signal becomes true, after the Holdoff time is satisfied.

A holdoff of 2 ms will work with most WiMAX signals, but there may be cases where the burst off duration is less than 1 ms and this value will need to be changed.

Key Path	Trigger, Periodic Timer
Remote Command	:TRIGger[:SEquence]:FRAMe:SYNC:HOLDoff <time> :TRIGger[:SEquence]:FRAMe:SYNC:HOLDoff?

	<code>:TRIGger[:SEquence]:FRAME:SYNC:HOLDoff:STATE OFF ON 0 1</code>
	<code>:TRIGger[:SEquence]:FRAME:SYNC:HOLDoff:STATE?</code>
Preset	On, 1.000 ms
State Saved	Saved in instrument state
Min	0 ms
Max	+500 ms
Default Unit	s
Initial S/W Revision	Prior to A.02.00

Auto/Holdoff

Opens up a menu that lets you adjust Auto Trigger and Trigger Holdoff parameters

Key Path	Trigger
Readback line	<p>Displays a summary of the Auto Trig and Holdoff settings, in square brackets</p> <p>First line: Auto Off or Auto On</p> <p>Second Line: "Hldf" followed by:</p> <ul style="list-style-type: none"> • If Holdoff is Off, readback Off • If Holdoff On and Type = Normal, readback value • If Holdoff On and Type = Above, readback value followed by AL • If Holdoff On and Type = Below, readback value followed by BL • If Holdoff Type selection is not supported by the current measurement, Holdoff Type is always Normal
Initial S/W Revision	A.02.00

Auto Trig

Sets the time that the analyzer will wait for the trigger conditions to be met. If they are not met after that much time, then the analyzer is triggered anyway.

Key Path	Trigger, Auto/Holdoff
Remote Command	<code>:TRIGger[:SEquence]:ATRigger <time></code> <code>:TRIGger[:SEquence]:ATRigger?</code> <code>:TRIGger[:SEquence]:ATRigger:STATE OFF ON 0 1</code> <code>:TRIGger[:SEquence]:ATRigger:STATE?</code>
Example	<p>TRIG:ATR:STAT ON</p> <p>TRIG:ATR 100 ms</p>
Notes	The "time that the analyzer will wait" starts when the analyzer is ready for a trigger, which may be hundreds of ms after the data acquisition for a sweep is done. The "time" ends when the trigger condition is satisfied, not when the delay ends.

Preset	Off, 100 ms
State Saved	Saved in instrument state
Min	1 ms
Max	100 s
Default Unit	s
Initial S/W Revision	Prior to A.02.00

Trig Holdoff

Sets the holdoff time between triggers. When the trigger condition is satisfied, the trigger occurs, the delay begins, and the holdoff time begins. New trigger conditions will be ignored until the holdoff time expires. For a free-running trigger, the holdoff value is the minimum time between triggers.

Key Path	Trigger, Auto/Holdoff
Remote Command	:TRIGger[:SEquence]:HOLDoff <time> :TRIGger[:SEquence]:HOLDoff? :TRIGger[:SEquence]:HOLDoff:STATe OFF ON 0 1 :TRIGger[:SEquence]:HOLDoff:STATe?
Example	TRIG:HOLD:STAT ON TRIG:HOLD 100 ms
Dependencies	Unavailable if the selected Input is BBIQ. If this is the case, the key is grayed out if it is pressed the informational message "Feature not supported for this Input" is displayed. If the SCPI command is sent, the error "Settings conflict; Feature not supported for this Input" is generated.
Preset	Off, 100 ms
State Saved	Saved in instrument state
Min	0 s
Max	0.5 s
Default Unit	s
Initial S/W Revision	Prior to A.02.00

Gate Preset (Remote Command Only)

Presets the time-gated spectrum analysis capability.

This command sets gate parameter values to the ESA preset values, as follows:

Gate delay = 1 us

Gate length = 1 us

Remote Command	[:SENSe]:SWEep:TIME:GATE:PRESet ESA Compatibility
Initial S/W Revision	Prior to A.02.00

Gate Level (Remote Command Only)

Sets the gate input transition point level for the external TRIGGER inputs on the front and rear panel. This is a legacy command for PSA compatibility. It is simply an alias to the equivalent trigger level command.

Remote Command	<code>[:SENSe] :SWEep:EGATe:EXTeRnal [1] 2 :LEVe1 <voltage></code> <code>[:SENSe] :SWEep:EGATe:EXTeRnal [1] 2 :LEVe1 ?</code>
Notes	This command is simply an alias to <code>:TRIGger[:SEQuence]:EXTeRnal[1] 2:LEVe1</code> For details refer
Initial S/W Revision	Prior to A.02.00

Gate Polarity (Remote Command Only)

Sets the polarity for the gate signal. This setup is now done using the gate trigger's slope setting.

When Positive (Pos) is selected, a positive-going edge (Edge) or a high voltage (Level) will satisfy the gate condition, after the delay set with the Gate Delay key. When Negative (Neg) is selected, a negative-going edge (Edge) or a low voltage (Level) will satisfy the gate condition after the delay.

Remote Command	<code>[:SENSe] :SWEep:EGATe:POLarity NEGative POSitive</code> <code>[:SENSe] :SWEep:EGATe:POLarity ?</code>
Example	<code>SWE:EGAT:POL NEG</code> <code>SWE:EGAT:POL ?</code>
Preset	POSitive
State Saved	Saved in instrument state
Backwards Compatibility SCPI	<code>[:SENSe] :SWEep:TIME:GATE:POLarity</code> ESA compatibility
Initial S/W Revision	Prior to A.02.00

Remote Command	<code>[:SENSe] :SWEep:TIME:GATE:LEVe1 HIGH LOW</code> <code>[:SENSe] :SWEep:TIME:GATE:LEVe1 ?</code> ESA compatibility
Preset	HIGH
Initial S/W Revision	Prior to A.02.00

Points

Sets the number of points per sweep. The resolution of setting the sweep time depends on the number of points selected. If Preset is selected, the number of points per sweep defaults to 1001. The current value

of points is displayed parenthetically, next to the sweep time in the lower-right corner of the display.

Changing the number of points has several effects on the analyzer. Since markers are read at the point location, the marker reading may change. All trace data is cleared.

Key Path	Sweep/Control
Mode	SA, WCDMA, C2K, WIMAX OFDMA, 1xEVDO, DVB-T/H, DTMB (CTTB), ISDB-T, CMMB, LTE, LTETDD, Digital Cable TV, WLAN, MSR, LTEAFDD, LTEATDD
Remote Command	[:SENSe] :CHPower:SWEep:POINts <integer> [:SENSe] :CHPower:SWEep:POINts?
Example	CHP:SWE:POIN 501 CHP:SWE:POIN?
Notes	Whenever the number of sweep points changes: All trace data is erased Any traces with Update Off also go to Display Off (like going from View to Blank in the older analyzers) Sweep time is re-quantized Any limit lines that are on are updated If averaging/hold is on, averaging/hold starts over
Couplings	Whenever the number of sweep points changes, the sweep time is re-quantized.
Preset	DVB-T/H: 2001 DTMB (CTTB): 2001 Other: 1001 ISDB-T: 2001 CMMB: 2001 1xEVDO: 512 Digital Cable TV: 2001
State Saved	Saved in instrument state.
Min	101
Max	20001
Initial S/W Revision	Prior to A.02.00
Modified at S/W Revision	A.02.00, A.03.00

System

See "[System](#)" on page 189

Trace/Detector

Accesses a menu of functions that enable you to control the detectors for the current measurement.

Key Path	Front-panel key
Initial S/W Revision	Prior to A.02.00

Trace Type

Allows you to select the type of trace you want to use for the current measurement. The first page of this menu contains a 1-of-N selection of the trace type (Clear Write, Average, Max Hold, Min Hold) for the selected trace.

Key Path	Trace/Detector
Mode	SA, WCDMA, C2K, WIMAX OFDMA, 1xEVDO, DVB-T/H, DTMB (CTTB), ISDB-T, CMMB, LTE, LTETDD, Digital Cable TV, WLAN, MSR, LTEAFDD, LTEATDD
Remote Command	:TRACe:CHPower:TYPE WRITe AVERAge MAXHold MINHold :TRACe:CHPower:TYPE?
Example	TRAC:CHP:TYPE WRIT TRAC:CHP:TYPE?
Notes	WRITe = Clear Write AVERAge = Average MAXHold = Maximum Hold MINHold = Minimum Hold
Couplings	When Detector setting is "Auto" ([:SENSe]:CHPower:DETECTOR:AUTO?), Detector ([:SENSe]:CHPower:DETECTOR[:FUNCTION]?) switches aligning with the switch of this parameter: "NORMal" with WRITe (Clear Write), "AVERAge" with AVERAge, "POSitive (peak)" with MAXHold, and "NEGative (peak)" with MINHold.
Preset	AVERAge
State Saved	Saved in instrument state.
Range	ClearWrite Average MaxHold MinHold
Initial S/W Revision	Prior to A.02.00
Modified at S/W Revision	A.02.00, A.03.00

Detector

Accesses a menu of functions that enable you to control the detectors for the current measurement. The following choices are available:

- Auto– the detector selected depends on marker functions, trace functions, average type, and the trace averaging function.

- Normal—the detector determines the peak of the CW-like signals, and it yields alternating maximums and minimums of noise-like signals. This is also referred to as Rosenfell detection.
- Average—the detector determines the average of the signal within the sweep points. The averaging method depends upon the Average Type selection (voltage, power or log scales).
- Peak—the detector determines the maximum of the signal within the sweep points.
- Sample—the detector indicates the instantaneous level of the signal at the center of the sweep points represented by each display point.
- Negative Peak—the detector determines the minimum of the signal within the sweep points.

Key Path	Detector
Initial S/W Revision	Prior to A.02.00

Auto

Sets the detector for the currently selected trace to Auto.

Key Path	Trace/Detector
Mode	SA, WCDMA, C2K, WIMAX OFDMA, 1xEVDO, DVB-T/H, DTMB (CTTB), ISDB-T, CMMB, LTE, LTETDD, Digital Cable TV, WLAN, MSR, LTEAFDD, LTEATDD
Remote Command	[[:SENSe]:CHPower:DETECTOR:AUTO ON OFF 1 0 [:SENSe]:CHPower:DETECTOR:AUTO?
Example	CHP:DET:AUTO ON CHP:DET:AUTO?
Couplings	When Detector setting is “Auto” ([[:SENSe]:CHPower:DETECTOR:AUTO?]), Detector ([[:SENSe]:CHPower:DETECTOR:FUNCTION?]) switches aligning with the switch of this parameter: “NORMal” with Clear Write, “AVERage” with AVERage, “POSitive (peak)” with MAXHold, and “NEGative (peak)” with MINHold.
Preset	Others: ON DVB-T/H, DTMB (CTTB), ISDB-T, CMMB, Digital Cable TV: OFF
State Saved	Saved in instrument state.
Initial S/W Revision	Prior to A.02.00
Modified at S/W Revision	A.02.00, A.03.00

Detector Selection

Selects a detector to be used by the analyzer for the current measurement.

Key Path	Trace/Detector
Mode	SA, WCDMA, C2K, WIMAX OFDMA, 1xEVDO, DVB-T/H, DTMB (CTTB), ISDB-T, CMMB, LTE, LTETDD, Digital Cable TV, WLAN, MSR, LTEAFDD, LTEATDD

Remote Command	[:SENSe]:CHPower:DETEctor[:FUNction] NORMal AVERage POSitive SAMPle NEGative [:SENSe]:CHPower:DETEctor[:FUNction]?
Example	CHP:DET NORM CHP:DET?
Notes	<p>When you manually select a detector (instead of selecting Auto), that detector is used regardless of other analyzer settings.</p> <p>The Normal detector determines the peak of CW-like signals, and it yields alternating maximums and minimums of noise-like signals. This method of detection is also referred to as Rosenfell detection.</p> <p>The Average detector determines the average of the signal within the sweep points. The averaging method is Power Average (RMS).</p> <p>The Peak detector determines the maximum of the signal within the sweep points.</p> <p>The Sample detector indicates the instantaneous level of the signal at the center of the sweep points represented by each display point.</p> <p>The Negative Peak detector determines the minimum of the signal within the sweep points.</p>
Couplings	When Detector setting is "Auto" ([:SENSe]:CHPower:DETEctor:AUTO?), Detector ([:SENSe]:CHPower:DETEctor[:FUNction]?) switches aligning with the switch of this parameter: "NORMal" with Clear Write, "AVERage" with AVERage, "POSitive (peak)" with MAXHold, and "NEGative (peak)" with MINHold.
Preset	AVERage
State Saved	Saved in instrument state.
Range	Normal Average Peak Sample Negative Peak
Initial S/W Revision	Prior to A.02.00
Modified at S/W Revision	A.02.00, A.03.00

Trigger

See ["Trigger" on page 248](#)

Free Run

See ["Free Run " on page 255](#)

Video

See ["Video \(IF Envelope\) " on page 1440](#)

Trigger Level

See ["Trigger Level " on page 1440](#)

Trig Slope

See ["Trig Slope " on page 1441](#)

Trig Delay

See ["Trig Delay " on page 258](#)

External 1

See ["External 1 " on page 1454](#)

Trigger Level

See ["Trigger Level " on page 1455](#)

Trig Slope

See ["Trig Slope " on page 1455](#)

Trig Delay

See ["Trig Delay " on page 261](#)

Zero Span Delay Comp

See ["Zero Span Delay Comp On/Off " on page 1443](#)

External 2

See ["External 2 " on page 1456](#)

Trigger Level

See ["Trigger Level " on page 1457](#)

Trig Slope

See ["Trig Slope " on page 1457](#)

Trig Delay

See ["Trig Delay "](#) on page 264

Zero Span Delay Comp

See ["Zero Span Delay Comp On/Off"](#) on page 1446

RF Burst

See ["RF Burst "](#) on page 1458

Absolute Trigger

See ["Absolute Trigger Level"](#) on page 1458

Relative Trigger

See ["Relative Trigger Level"](#) on page 1448

Trig Slope

See ["Trigger Slope "](#) on page 1459

Trig Delay

See ["Trig Delay "](#) on page 268

Periodic Timer

See ["Periodic Timer \(Frame Trigger\) "](#) on page 1449

Period

See ["Period "](#) on page 1451

Offset

See ["Offset "](#) on page 1451

Offset Adjust (Remote Command Only)

See ["Offset Adjust \(Remote Command Only\)"](#) on page 1452

Reset Offset Display

See ["Reset Offset Display "](#) on page 1453

Sync Source

See ["Sync Source "](#) on page 1453

Off

See ["Off "](#) on page 1454

External 1

See ["External 1 "](#) on page 1454

Trigger Level

See ["Trigger Level "](#) on page 1455

Trig Slope

See ["Trig Slope "](#) on page 1455

External 2

See ["External 2 "](#) on page 1456

Trigger Level

See ["Trigger Level "](#) on page 1457

Trig Slope

See ["Trig Slope "](#) on page 1457

RF Burst

See ["RF Burst "](#) on page 1458

Absolute Trigger

See ["Absolute Trigger Level"](#) on page 1458

Trig Slope

See ["Trigger Slope "](#) on page 1459

Trig Delay

See ["Trig Delay"](#) on page 280

Auto/Holdoff

See ["Auto/Holdoff "](#) on page 1460

Auto Trig

See ["Auto Trig "](#) on page 1461

Trig Holdoff

See ["Trig Holdoff "](#) on page 1461

Internal

See ["Internal"](#) on page 282

User Preset

Accesses a menu that gives you the following three choices:

- User Preset – recalls a state previously saved using the Save User Preset function.
- User Preset All Modes – presets all of the modes in the analyzer
- Save User Preset– saves the current state for the current mode

NOTE

In products that run multiple instances of the X-Series Application, all instances use the same location to save User Preset state. So Save User Preset of one instance will overwrite the Save User Preset of another instance.

Key Path	Front-panel key
Backwards Compatibility Notes	<p>User Preset is actually loading a state, and in legacy analyzers, it was possible to load a state without affecting the trace data, limit lines or correction data. Similarly it was possible to do a User Preset without affecting the trace data, limit lines or correction data.</p> <p>In the X-Series, “state” always includes all of this data; so whenever state is loaded, or User Preset is executed, all of the traces, limit lines and corrections are affected. Although this differs from previous behavior, it is desirable behavior, and should not cause adverse issues for users.</p> <p>On ESA and PSA, User Preset affected the entire instrument’s state. In the X-Series, User Preset only recalls the state for the active mode. There is a User Preset file for each mode. User Preset can never cause a mode switch as it can in legacy analyzers. If you want to recall all modes to their user preset file state, you will need to do a User Preset after mode switching into each mode.</p> <p>User Preset recalls mode state which can now include data like traces; whereas on ESA and PSA, User Preset did not affect data.</p>
Initial S/W Revision	Prior to A.02.00

User Preset

User Preset sets the state of the currently active mode back to the state that was previously saved for this mode using the Save User Preset menu key or the SCPI command, SYST:PRES:USER:SAV. It not only recalls the Mode Preset settings, but it also recalls all of the mode persistent settings, and the Input/Output system setting that existed at the time Save User Preset was executed.

If a Save User Preset has not been done at any time, User Preset recalls the default user preset file for the currently active mode. The default user preset files are created if, at power-on, a mode detects there is no user preset file. There will never be a scenario when there is no user preset file to restore. For each mode, the default user preset state is the same state that would be saved if a Save User Preset is performed in each mode right after doing a Restore Mode Default and after a Restore Input/Output Defaults.

The User Preset function does the following:

- Aborts the currently running measurement.
- Sets the mode State to the values defined by Save User Preset.
- Makes the saved measurement for the currently running mode the active measurement.
- Brings up the saved menu for the power-on mode.

- Clears the input and output buffers.
- Sets the Status Byte to 0.

Key Path	User Preset
Remote Command	:SYSTem:PRESet:USER
Example	:SYST:PRES:USER:SAVE:SYST:PRES:USER
Notes	:SYST:PRES:USER:SAVE is used to save the current state as the user preset state. Clears all pending OPC bits. The Status Byte is set to 0. Pressing the User Preset front-panel key while already in the User Preset menu will cause the User Preset to get executed
Couplings	A user preset will cause the currently running measurement to be aborted and cause the saved measurement to be active. Recalling a User Preset file has the same issues that recalling a Save State file has. Some settings may need to be limited and therefore re-coupled, since the capabilities of the mode may have changes when the User Preset file was last saved.
Initial S/W Revision	Prior to A.02.00

User Preset All Modes

Recalls all of the User Preset files for each mode, switches to the power-on mode, and activates the saved measurement from the power-on mode User Preset file.

NOTE

When the instrument is secured, all of the user preset files are converted back to their default user preset files.

The User Preset function does the following:

- Aborts the currently running measurement.
- Switches the Mode to the power-on mode.
- Restores the User Preset files for each mode.
- Makes the saved measurement for the power-on mode the active measurement.
- Brings up the saved menu for the power-on mode.
- Clears the input and output buffers.
- Sets the Status Byte to 0.

Key Path	User Preset
Remote Command	:SYSTem:PRESet:USER:ALL
Example	:SYST:PRES:USER:SAVE:SYST:PRES:USER:ALL
Notes	Clears all pending OPC bits. The Status Byte is set to 0. :SYST:PRES:USER:SAVE is used to save the current state as the user preset state.
Couplings	A user preset will cause the currently running measurement to be aborted, cause a mode switch to the power-on mode, and cause the saved measurement to be active in the power-on mode.

Recalling a User Preset file has the same issues that recalling a Save State file has. Some settings may need to be limited and therefore re-coupled, since the capabilities of the mode may have changes when the User Preset file was last saved.

Initial S/W Revision Prior to A.02.00

Save User Preset

Saves the currently active mode and its State. You can recall this User Preset file by pressing the User Preset menu key or sending the SYST:PRES:USER remote command. This same state is also saved by the Save State function.

Key Path	User Preset
Remote Command	:SYSTem:PRESet:USER:SAVE
Example	:SYST:PRES:USER:SAVE
Notes	:SYST:PRES:SAVE creates the same file as if the user requested a *SAV or a MMEM:STOR:STAT, except User Preset Save does not allow the user to specify the filename or the location of the file.
Initial S/W Revision	Prior to A.02.00

View/Display

Accesses a menu of functions that enable you to control the instrument display as well as turn the bar graph On and Off.

The results of the measurement can be displayed as a single spectrum trace view or displayed with a Bar Graph trace on the spectrum trace.

Spectrum View with Bar Graph off

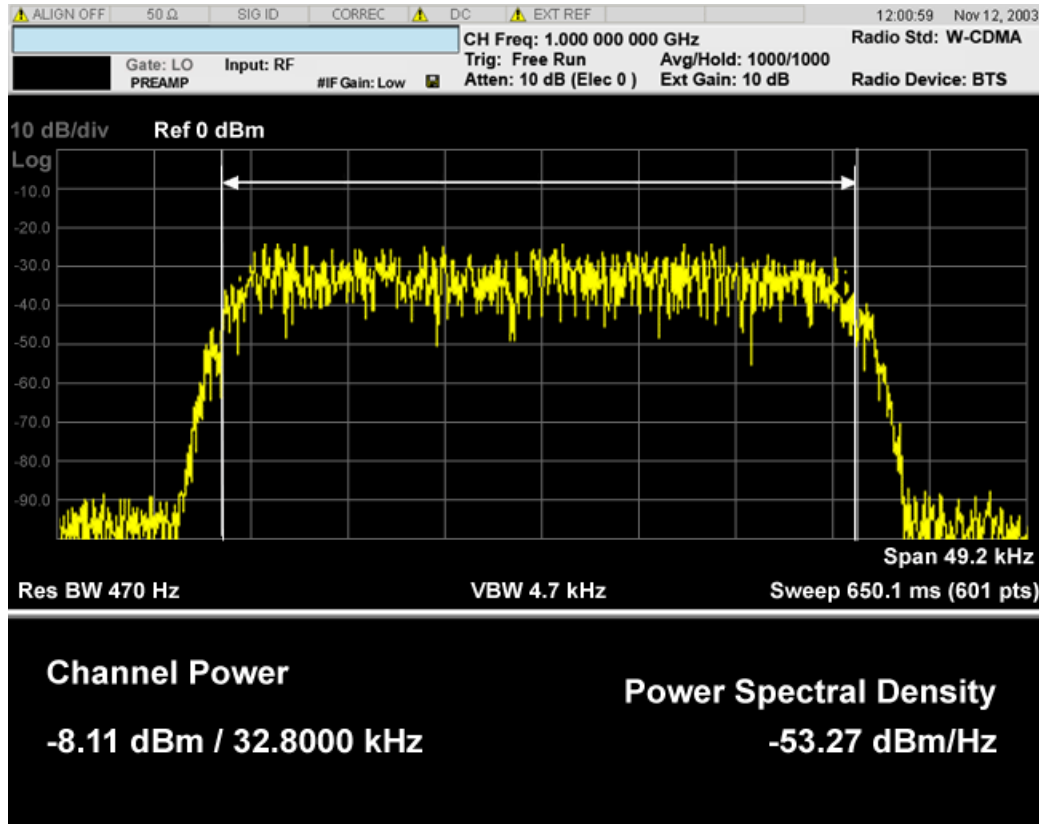

Spectrum View with Bar Graph on

This View is the same as the 'Spectrum' view, but has a blue bar between the markers that indicates the measured output power level. The bar graph is activated when the "Bar Graph" Soft Key is set to ON under the View/Display menu. The actual measured output power level is displayed on the display at the bottom of the bar.

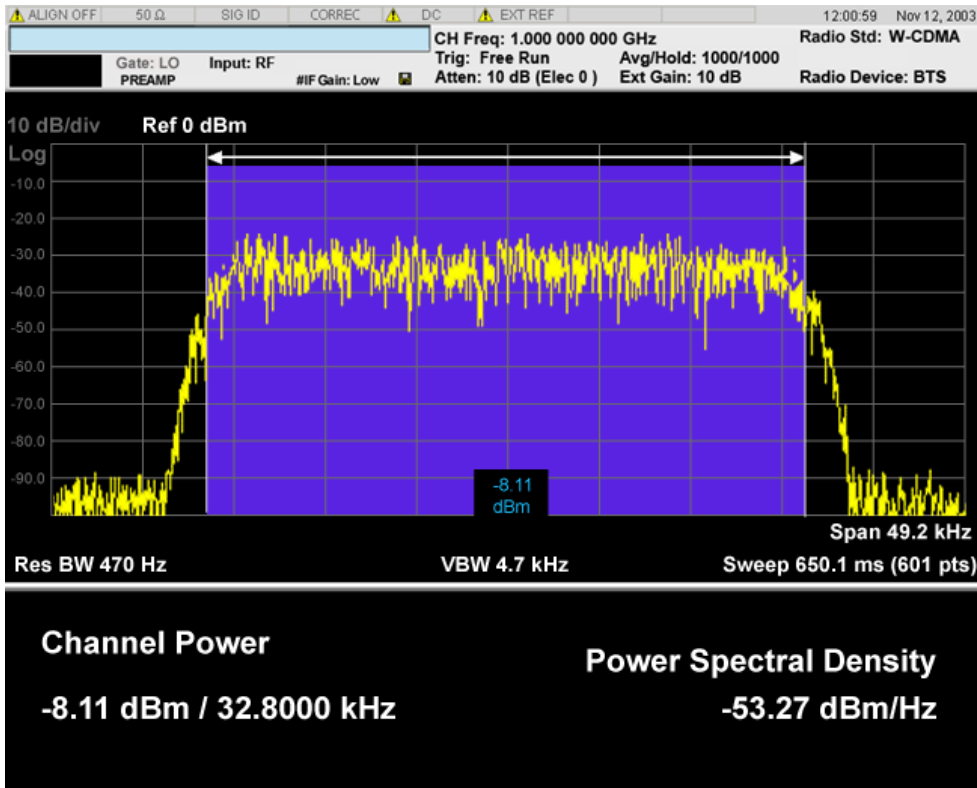

If the current mode is WLAN and the format is WLAN 802.11 ac 80+80 MHz, the spectrum view is changed a little so that the results of both carrier segments can be displayed.

Spectrum View with Bar Graph off for WLAN 802.11 ac (80 + 80 MHz):

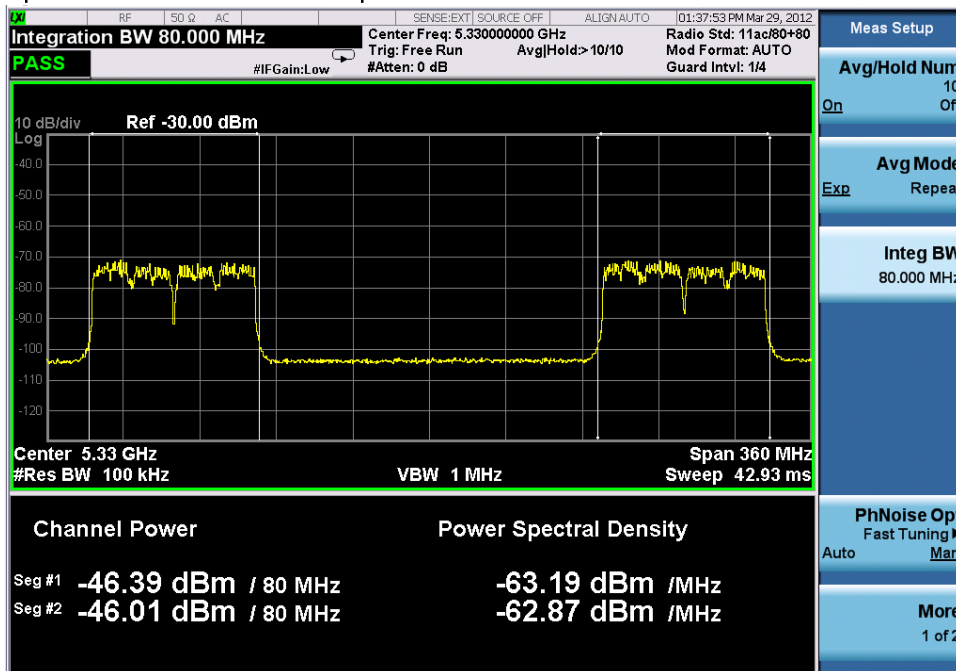

Spectrum View with Bar Graph on for WLAN 802.11 ac (80 + 80 MHz):

8 Channel Power Measurement View/Display

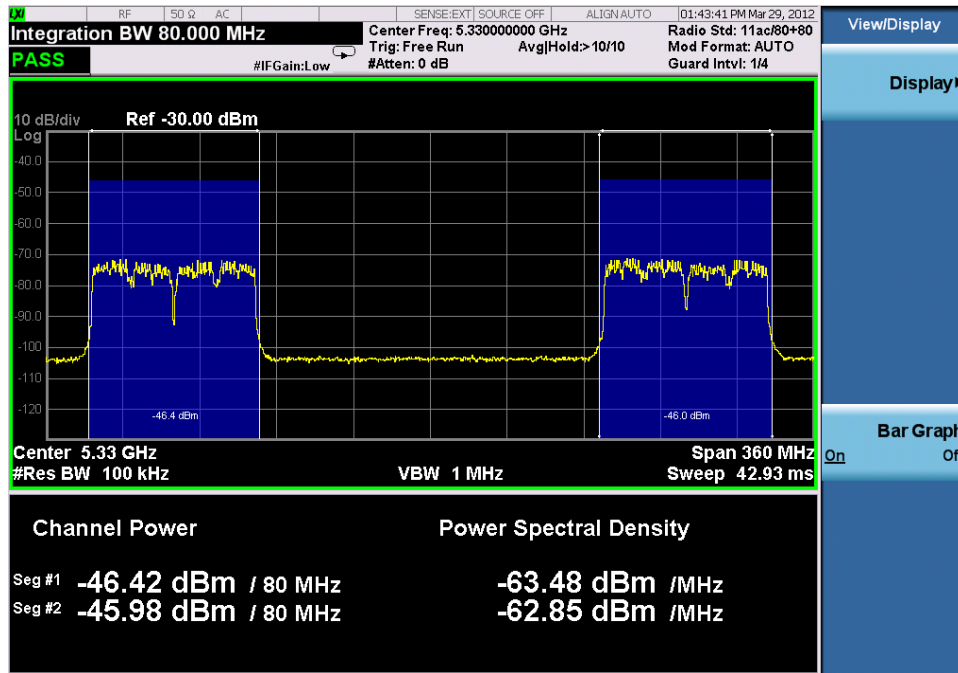

Power Results:

The spectrum trace and power bars are displayed in the upper window. Total carrier power, total PSD and total format carrier power are displayed in the lower window. Total format carrier power is total power of carriers of the same Radio Format. If there is no carrier of the corresponding format, it is not displayed. Thus items in the total format power table changes depending on the carrier configuration.

Carrier Info:

The lower window of Power Results view is replaced by the carrier info table in this view. Carrier center frequency can be displayed in either offset or absolute frequency depending on Carrier Freq. The table can be scrolled by Carrier Result on Meas Setup menu or by Select Carrier on Config Carriers menu. The highlighted row changes as either Carrier Result or Select Carrier is changed. The highlighted row and these keys are not coupled.

Key Path	Front-panel key
Initial S/W Revision	Prior to A.02.00

Display

The Display menu is common to most measurements, and is used for configuring items on the display. Some Display menu settings apply to all the measurements in a mode, and some only to the current measurement. Those under the System Display Settings key apply to all measurements in all modes.

Key Path	Display
Key Path	View/Display
Initial S/W Revision	Prior to A.02.00

Annotation

Turns on and off various parts of the display annotation. The annotation is divided up into four categories:

1. Meas Bar: This is the measurement bar at the top of the screen. It does not include the settings panel or the Active Function. Turning off the Meas Bar turns off the settings panel and the Active Function. When the Meas Bar is off, the graticule area expands to fill the area formerly occupied by the Meas Bar.
2. Screen Annotation: this is the annotation and annunciation around the graticule, including any annotation on lines (such as the display line, the threshold line, etc.) This does NOT include the marker number or the N dB result. When off, the graticule expands to fill the entire graticule area.
3. Trace annotation: these are the labels on the traces, showing their detector (or their math mode).
4. Active Function annotation: this is the active function display in the meas bar, and all of the active function values displayed on softkeys.

See the figure below. Each type of annotation can be turned on and off individually.

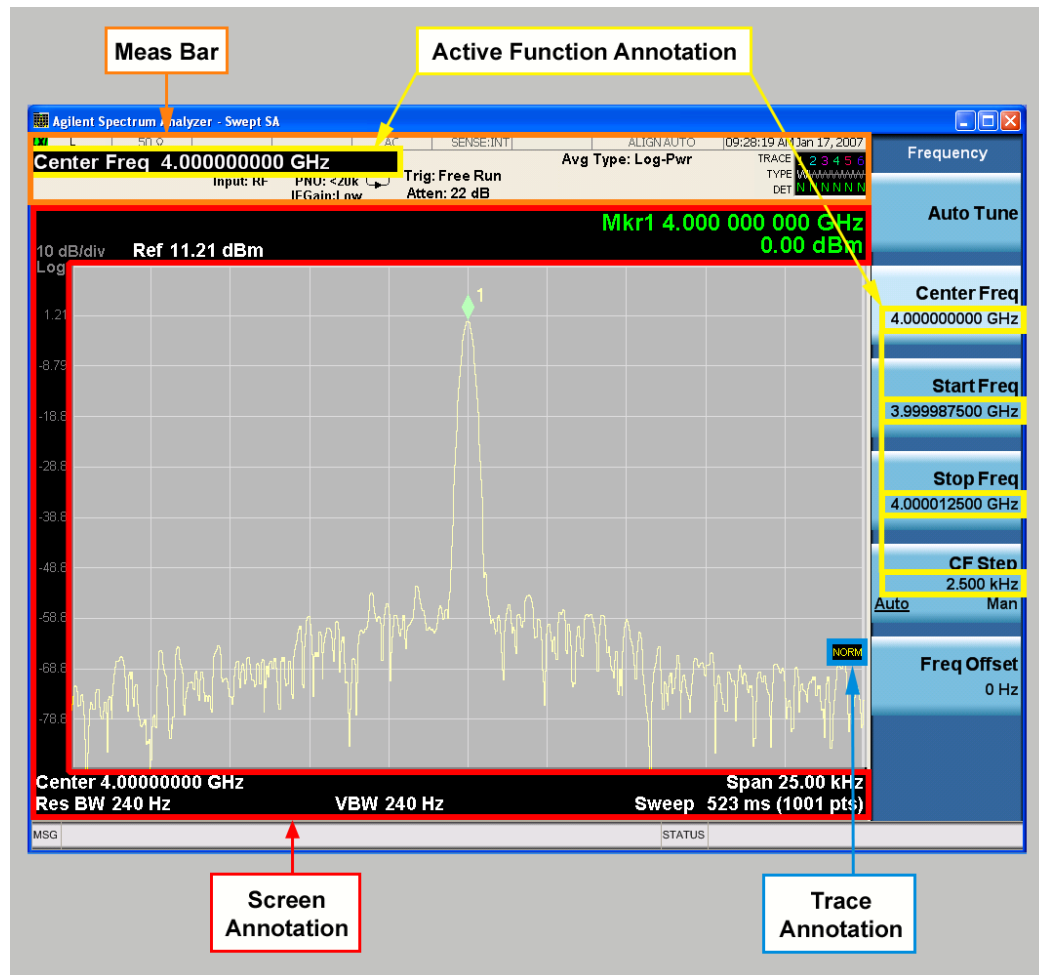

Key Path	View/Display, Display
Initial S/W Revision	Prior to A.02.00

Meas Bar On/Off

This function turns the Measurement Bar on and off, including the settings panel. When off, the graticule area expands to fill the area formerly occupied by the Measurement Bar.

Key Path	View/Display, Display, Annotation
Remote Command	:DISPlay:ANNotation:MBAR[:STATe] OFF ON 0 1 :DISPlay:ANNotation:MBAR[:STATe]?
Example	DISP:ANN:MBAR OFF
Dependencies	Grayed out and forced to OFF when System Display Settings, Annotation is set to Off.
Preset	On This should remain Off through a Preset when System DisplaySettings, Annotation is set to Off.
State Saved	Saved in instrument state.
Initial S/W Revision	Prior to A.02.00

Screen

This controls the display of the annunciation and annotation around the graticule, including any annotation on lines (such as the display line, the threshold line, etc.) and the y-axis annotation. This does NOT include marker annotation (or the N dB result). When off, the graticule expands to fill the entire graticule area, leaving only the 1.5% gap above the graticule as described in the Trace/Detector chapter.

Key Path	View/Display, Display, Annotation
Remote Command	:DISPlay:ANNotation:SCReen[:STATe] OFF ON 0 1 :DISPlay:ANNotation:SCReen[:STATe]?
Example	DISP:ANN:SCR OFF
Dependencies	Grayed-out and forced to OFF when System Display Settings, Annotation is set to Off.
Preset	On This should remain Off through a Preset when System DisplaySettings, Annotation is set to Off
State Saved	Saved in instrument state.
Initial S/W Revision	Prior to A.02.00

Active Function Values On/Off

Turns on and off the active function display in the Meas Bar, and all of the active function values displayed on the softkeys.

Note that all of the softkeys that have active functions have these numeric values blanked when this function is on. This is a security feature..

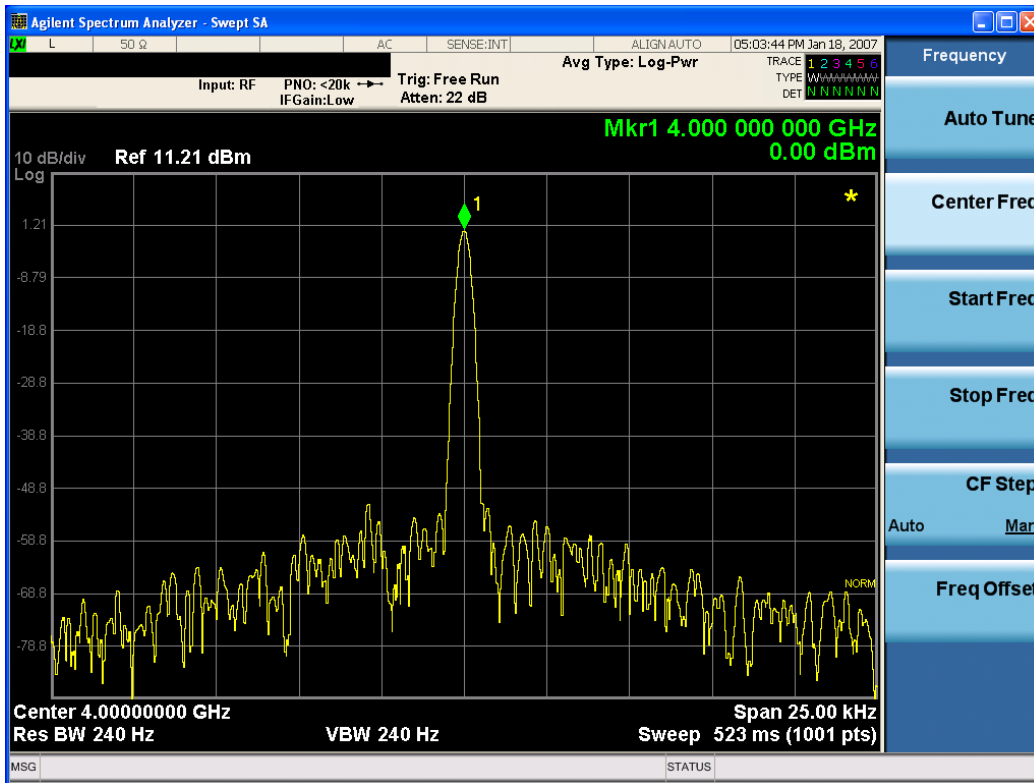

Key Path	View/Display, Display, Annotation
Remote Command	:DISPlay:ACTivefunc[:STATE] ON OFF 1 0 :DISPlay:ACTivefunc[:STATE]?
Example	DISP:ACT OFF
Dependencies	Grayed out and forced to OFF when System Display Settings, Annotation is set to Off.
Preset	On This should remain Off through a Preset when System DisplaySettings, Annotation is set to Off
State Saved	Saved in instrument state.
Initial S/W Revision	Prior to A.02.00

Title

Displays menu keys that enable you to change or clear a title on your display.

Key Path	View/Display, Display
Initial S/W Revision	Prior to A.02.00

Change Title

Writes a title into the "measurement name" field in the banner, for example, "Swept SA".

Press Change Title to enter a new title through the alpha editor. Press Enter or Return to complete the entry. Press ESC to cancel the entry and preserve your existing title.

The display title will replace the measurement name. It remains for this measurement until you press Change Title again, or you recall a state, or a Preset is performed. A title can also be cleared by pressing Title, Clear Title.

NOTE

Notice the inclusion of the <measurement> parameter in the command below. Because each measurement remembers the Display Title, the command must be qualified with the measurement name. For the Swept SA measurement this is not the case; no <measurement> parameter is used when changing the Display Title for the Swept SA measurement.

Key Path	View/Display, Display, Title
Mode	All
Remote Command	:DISPlay:<measurement>:ANNotation:TITLe:DATA <string> :DISPlay:<measurement>:ANNotation:TITLe:DATA?
Example	DISP:ANN:TITL:DATA "This Is My Title" This example is for the Swept SA measurement in the Spectrum Analyzer mode. The SANalyzer <measurement> name is not used. DISP:ACP:ANN:TITL:DATA "This Is My Title" This example is for Measurements other than Swept SA. Both set the title to: This Is My Title
Notes	Pressing this key cancels any active function. When a title is edited the previous title remains intact (it is not cleared) and the cursor goes at the end so that characters can be added or BKSP can be used to go back over previous characters.
Preset	No title (measurement name instead)
State Saved	Saved in instrument state.
Initial S/W Revision	Prior to A.02.00

Clear Title

Clears a title from the front-panel display. Once cleared, the title cannot be retrieved. After the title is cleared, the current Measurement Name replaces it in the title bar.

Key Path	View/Display, Display, Title
Example	The following commands clear the title and restore the measurement's original title: DISP:ANN:TITL:DATA "" This example is for the Swept SA measurement in the Spectrum Analyzer mode. The SANalyzer <measurement> name is not used. DISP:ACP:ANN:TITL:DATA "" This example is for ACP; in measurements other than Swept SA the measurement name is required.

Notes	Uses the :DISPlay:<measurement>:ANNOtation:TITLe:DATA <string> command with an empty string (in the Swept SA, the <measurement> is omitted).
Preset	Performed on Preset.
Initial S/W Revision	Prior to A.02.00

Graticule

Pressing Graticule turns the display graticule On or Off. It also turns the graticule y-axis annotation on and off.

Key Path	View/Display, Display
Remote Command	:DISPlay:WINDow[1]:TRACe:GRATicule:GRID[:STATe] OFF ON 0 1 :DISPlay:WINDow[1]:TRACe:GRATicule:GRID[:STATe]?
Example	DISP:WIND:TRAC:GRAT:GRID OFF
Notes	The graticule is the set of horizontal and vertical lines that make up the grid/divisions for the x-axis and y-axis.
Preset	On
State Saved	Saved in instrument state
Initial S/W Revision	Prior to A.02.00

System Display Settings

These settings are "Mode Global" – they affect all modes and measurements and are reset only by Restore Misc Defaults or Restore System Defaults under System.

Key Path	View/Display, Display
Initial S/W Revision	Prior to A.02.00

Annotation Local Settings

This is a Mode Global override of the meas local annotation settings. When it is All Off, it forces ScreenAnnotation, Meas Bar, Trace, and Active Function Values settings to be OFF for all measurements in all modes. This provides the security based "annotation off" function of previous analyzers; hence it uses the legacy SCPI command.

When it is All Off, the Screen, Meas Bar, Trace, and Active Function Values keys under the Display, Annotation menu are grayed out and forced to Off. When Local Settings is selected, you are able to set the local annotation settings on a measurement by measurement basis.

Key Path	View/Display, Display, System Display Settings
Remote Command	:DISPlay:WINDow[1]:ANNOtation[:ALL] OFF ON 0 1

	:DISPlay:WINDow[1]:ANNotation[:ALL]?
Example	:DISP:WIND:ANN OFF
Preset	On (Set by Restore Misc Defaults)
State Saved	Not saved in instrument state.
Backwards Compatibility Notes	The WINDow parameter and optional subopcode is included for backwards compatibility but ignored - all windows are equally affected.
Initial S/W Revision	Prior to A.02.00

Themes

Accesses a menu of functions that enable you to choose the theme to be used when saving the screen image.

The **Themes** option is the same as the **Themes** option under the **Display** and **Page Setup** dialogs. It allows you to choose between themes to be used when saving the screen image.

Key Path	Save, Screen Image
Remote Command	:MMEMory:STORe:SCReem:THEMe TDColor TDMonochrome FCOLor FMONochrome :MMEMory:STORe:SCReem:THEMe?
Example	:MMEM:STOR:SCR:THEM TDM
Preset	3D Color; Is not part of Preset, but is reset by Restore Misc Defaults or Restore System Defaults All and survives subsequent running of the modes.
Readback	3D Color 3D Mono Flat Color Flat Mono
Backwards Compatibility Notes	In ESA and PSA we offer the choice of "Reverse Bitmap" or "Reverse Metafile" when saving screen images. This is much like the "Flat Color" theme available in X-Series. Also, if you selected Reverse Bitmap AND a black & white screen image, that would be much like "Flat Monochrome". In other words, each of the X-Series themes has a similar screen image type in ESA/PSA. But they are not identical.
Initial S/W Revision	Prior to A.02.00

3D Color

Selects a standard color theme with each object filled, shaded and colored as designed.

Key Path	Save, Screen Image, Themes
Example	MMEM:STOR:SCR:THEM TDC
Readback	3D Color
Initial S/W Revision	Prior to A.02.00

3D Monochrome

Selects a format that is like 3D color but shades of gray are used instead of colors.

Key Path	Save, Screen Image, Themes
Example	MMEM:STOR:SCR:THEM TDM
Readback	3D Mono
Initial S/W Revision	Prior to A.02.00

Flat Color

Selects a format that is best when the screen is to be printed on an ink printer.

Key Path	Save, Screen Image, Themes
Example	MMEM:STOR:SCR:THEM FCOL
Readback	Flat Color
Initial S/W Revision	Prior to A.02.00

Flat Monochrome

Selects a format that is like Flat Color. But only black is used (no colors, not even gray), and no fill.

Key Path	Save, Screen Image, Themes
Example	MMEM:STOR:SCR:THEM FMON
Readback	Flat Mono
Initial S/W Revision	Prior to A.02.00

Bar Graph

Turns the Bar Graph On and Off.

Key Path	DVB-T/H, DTMB (CTTB), ISDB-T, CMMB: View/Display, RF SpectrumOthers: View/Display
Mode	SA, WCDMA, C2K, WIMAX OFDMA, 1xEVDO, DVB-T/H, DTMB (CTTB), ISDB-T, CMMB, LTE, LTE-TDD, Digital Cable TV, WLAN, MSR, LTEAFDD, LTEATDD
Remote Command	:DISPlay:CHPower:VIEW[1]:WINDow[1]:BGRaph ON OFF 1 0 :DISPlay:CHPower:VIEW[1]:WINDow[1]:BGRaph?
Example	DISP:CHP:VIEW:WIND:BGR ON DISP:CHP:VIEW:WIND:BGR?
Notes	You must be in the Spectrum Analysis mode, W-CDMA mode, cdma2000 mode, DVB-T/H mode, DTMB (CTTB) mode, ISDB-T mode, CMMB mode, Digital Cable TV mode, LTE mode, LTE TDD mode, WLAN mode, 1xEVDO mode, MSR, LTE-Advanced FDD/TDD mode or WIMAX OFDMA mode to use this command. Use :INSTRument:SElect to set the mode.

8 Channel Power Measurement
View/Display

Preset	OFF
State Saved	Saved in instrument state.
Range	On Off
Initial S/W Revision	Prior to A.02.00
Modified at S/W Revision	A.02.00, A.03.00

9 ACP Measurement

ACP is a measurement of the amount of interference, or power, in an adjacent frequency channel. The results are displayed as a bar graph or as spectrum data, with measurement data at specified offsets. For measurement results and views, see ["View/Display" on page 857](#).

This topic contains the following sections:

["Measurement Commands for ACP" on page 554](#)

["Remote Command Results for ACP Measurement" on page 555](#)

Measurement Commands for ACP

The following commands are used to retrieve the measurement results:

```
:CONFigure:ACP  
:CONFigure:ACP:NDEFault  
:INITiate:ACP  
:FETCh:ACP[n]?  
:READ:ACP[n]?  
:MEASure:ACP[n]?
```

For more measurement related commands, see the SENSE subsystem, and the section Remote Measurement Functions@29978.

Remote Command Results for ACP Measurement

Condition	N	Results Returned
Mode = SA mode, Radio Std = None, Number of carriers = 1 and only offset A is on	Not specified or n = 1	Returns 3 comma-separated values that correspond to: Reference carrier power, lower-adjacent channel power (dBc), and upper-adjacent channel power (dBc).
Mode = DTMB (CTTB) or CMMB, Radio BW = 8 MHz, Number of carriers = 1 and Meas Type = Power spectral density reference	not specified or n = 1	Returns 32 comma-separated scalar results, in the following order. 1. 0.0 2. Total carrier power (dBm/Hz or dBm/MHz) 3. 0.0 4. Reference carrier power (dBm/Hz or dBm/MHz) 5. Lower offset A - relative power (dB) 6. Lower offset A - absolute power (dBm/Hz or dBm/MHz) 7. Upper offset A - relative power (dB) 8. Upper offset A - absolute power (dBm/Hz or dBm/MHz) 9. Lower offset B - relative power (dB) 10. Lower offset B - absolute power (dBm/Hz or dBm/MHz) 11. Upper offset B - relative power (dB) 12. Upper offset B - absolute power (dBm/Hz or dBm/MHz) ... 25. Lower offset F - relative power (dB) 26. Lower offset F - absolute power (dBm/Hz or dBm/MHz) 27. Upper offset F - relative power (dB) 28. Upper offset F - absolute power (dBm/Hz or dBm/MHz) 29. -999.0 30. -999.0 31. -999.0 32. -999.0 The last four (29, 30, 31 and 32) results always returned -999.0. If the results are not available, -999.0 is returned.
Meas Type = Total power reference	Not specified or n = 1	Returns 28 comma-separated scalar results, in the following order. 1. 0.0 2. Total carrier power (dBm) 3. 0.0 4. Reference carrier power (dBm) 5. Lower offset A - relative power (dB) 6. Lower offset A - absolute power (dBm) 7. Upper offset A - relative power (dB) 8. Upper offset A - absolute power (dBm)

Condition	N	Results Returned
		9. Lower offset B - relative power (dB) 10. Lower offset B - absolute power (dBm) 11. Upper offset B - relative power (dB) 12. Upper offset B - absolute power (dBm) ... 25. Lower offset F - relative power (dB) 26. Lower offset F - absolute power (dBm) 27. Upper offset F - relative power (dB) 28. Upper offset F - absolute power (dBm) If the results are not available, -999.0 is returned. When in MSR and LTE-Advanced FDD/TDD, this trace includes only outer offset results and their reference value(s).
Meas Type = Power spectral density reference	not specified or n = 1	Returns 28 comma-separated scalar results, in the following order. 1. 0.0 2. Total carrier power (dBm/Hz or dBm/MHz) 3. 0.0 4. Reference carrier power (dBm/Hz or dBm/MHz) 5. Lower offset A - relative power (dB) 6. Lower offset A - absolute power (dBm/Hz or dBm/MHz) 7. Upper offset A - relative power (dB) 8. Upper offset A - absolute power (dBm/Hz or dBm/MHz) 9. Lower offset B - relative power (dB) 10. Lower offset B - absolute power (dBm/Hz or dBm/MHz) 11. Upper offset B - relative power (dB) 12. Upper offset B - absolute power (dBm/Hz or dBm/MHz) ... 25. Lower offset F - relative power (dB) 26. Lower offset F - absolute power (dBm/Hz or dBm/MHz) 27. Upper offset F - relative power (dB) 28. Upper offset F - absolute power (dBm/Hz or dBm/MHz) If the results are not available, -999.0 is returned. When in MSR and LTE-Advanced FDD/TDD, this trace includes only outer offset results and their reference value(s).
Meas Method = FAST	not specified or n = 1	Returns 5 comma-separated results, in the following order: 1. Reference carrier - absolute power (dBm) 2. Lower offset A - absolute power (dBm) 3. Upper offset A - absolute power (dBm) 4. Lower offset B - absolute power (dBm) 5. Upper offset B - absolute power (dBm)
Mode = MSR , LTEAFDD,	Not specified	Returns 28 comma-separated scalar results, in the following order.

Condition	N	Results Returned
LTEATDD, Meas Type = Total power reference and Power Ref = Left & Right Carriers	or n = 1	<ol style="list-style-type: none"> 1. 0.0 2. Total carrier power (dBm) 3. Left Reference carrier power (dBm) 4. Right Reference carrier power (dBm) 5. Lower offset A - relative power (dB) 6. Lower offset A - absolute power (dBm) 7. Upper offset A - relative power (dB) 8. Upper offset A - absolute power (dBm) 9. Lower offset B - relative power (dB) 10. Lower offset B - absolute power (dBm) 11. Upper offset B - relative power (dB) 12. Upper offset B - absolute power (dBm) ... 25. Lower offset F - relative power (dB) 26. Lower offset F - absolute power (dBm) 27. Upper offset F - relative power (dB) 28. Upper offset F - absolute power (dBm) <p>If the results are not available, -999.0 is returned.</p>
Mode = MSR , LTEAFDD, LTEATDD, Meas Type = Power spectral density reference and Power Ref = Left & Right Carriers	not specified or n = 1	<p>Returns 28 comma-separated scalar results, in the following order.</p> <ol style="list-style-type: none"> 1. 0.0 2. Total carrier power (dBm/Hz or dBm/MHz) 3. Left reference carrier power (dBm/Hz or dBm/MHz) 4. Right reference carrier power (dBm/Hz or dBm/MHz) 5. Lower offset A - relative power (dB) 6. Lower offset A - absolute power (dBm/Hz or dBm/MHz) 7. Upper offset A - relative power (dB) 8. Upper offset A - absolute power (dBm/Hz or dBm/MHz) 9. Lower offset B - relative power (dB) 10. Lower offset B - absolute power (dBm/Hz or dBm/MHz) 11. Upper offset B - relative power (dB) 12. Upper offset B - absolute power (dBm/Hz or dBm/MHz) ... 25. Lower offset F - relative power (dB) 26. Lower offset F - absolute power (dBm/Hz or dBm/MHz) 27. Upper offset F - relative power (dB) 28. Upper offset F - absolute power (dBm/Hz or dBm/MHz) <p>If the results are not available, -999.0 is returned.</p> <p>When in MSR and LTE-Advanced FDD/TDD, this trace includes only outer offset results and their reference value(s).</p>
Meas Type = Total	n = 2	Returns 48 scalar results, in the following order:

Condition	N	Results Returned
power reference		1. Channel (1) - relative power (dB) 2. Channel (1) - absolute power (dBm) 3. Channel (2) - relative power (dB) 4. Channel (2) - absolute power (dBm) ... 23. Channel (12) - relative power (dB) 24. Channel (12) - absolute power (dBm) 25. Lower offset A - relative power (dB) 26. Lower offset A - absolute power (dBm) 27. Upper offset A - relative power (dB) 28. Upper offset A - absolute power (dBm) 29. Lower offset B - relative power (dB) 30. Lower offset B - absolute power (dBm) 31. Upper offset B - relative power (dB) 32. Upper offset B - absolute power (dBm) ... 45. Lower offset F - relative power (dB) 46. Lower offset F - absolute power (dBm) 47. Upper offset F - relative power (dB) 48. Upper offset F - absolute power (dBm) If the results are not available, -999.0 is returned. When in MSR and LTE-Advanced FDD/TDD, this trace includes only outer offset results and their reference value(s).
Meas Type = Power spectral density reference	n = 2	Returns 48 scalar results, in the following order: 1. Channel (1) - relative power (dB) 2. Channel (1) - absolute power (dBm/Hz or dBm/MHz) 3. Channel (2) - relative power (dB) 4. Channel (2) - absolute power (dBm/Hz or dBm/MHz) ... 23. Channel (12) - relative power (dB) 24. Channel (12) - absolute power (dBm/Hz or dBm/MHz) 25. Lower offset A - relative power (dB) 26. Lower offset A - absolute power (dBm/Hz or dBm/MHz) 27. Upper offset A - relative power (dB) 28. Upper offset A - absolute power (dBm/Hz or dBm/MHz) 29. Lower offset B - relative power (dB) 30. Lower offset B - absolute power (dBm/Hz or dBm/MHz) 31. Upper offset B - relative power (dB) 32. Upper offset B - absolute power (dBm/Hz or dBm/MHz)

Condition	N	Results Returned
		<p>...</p> <p>45. Lower offset F - relative power (dB)</p> <p>46. Lower offset F - absolute power (dBm/Hz or dBm/MHz)</p> <p>47. Upper offset F - relative power (dB)</p> <p>48. Upper offset F - absolute power (dBm/Hz or dBm/MHz)</p> <p>If the results are not available, -999.0 is returned.</p> <p>When in MSR and LTE-Advanced FDD/TDD, this trace includes only outer offset results.</p>
Mode = DTMB (CTTB) or CMMB, Radio BW = 8 MHz and Meas Type = Total power reference	n = 3	<p>Returns 28 scalar values of the pass/fail (0 = passed, or 1 = failed) determined by testing the relative to the reference carrier and by testing the absolute power limit of the offset frequencies (measured as total power in dB):</p> <ol style="list-style-type: none"> 1. Lower offset A - relative limit result 2. Lower offset A - absolute limit result 3. Upper offset A - relative limit result 4. Upper offset A - absolute limit result 5. Lower offset B - relative limit result 6. Lower offset B - absolute limit result 7. Upper offset B - relative limit result 8. Upper offset B - absolute limit result <p>...</p> <ol style="list-style-type: none"> 21. Lower offset F - relative limit result 22. Lower offset F - absolute limit result 23. Upper offset F - relative limit result 24. Upper offset F - absolute limit result 25. Inside Adjacent Channel - relative limit result 26. Inside Adjacent Channel - absolute limit result 27. Outside Adjacent Channel - relative limit result 28. Outside Adjacent Channel - absolute limit result <p>If Radio Device = Exciter, the last four (25, 26, 27 and 28) results returned -999.0.</p>
Mode = DTMB (CTTB) or CMMB, Radio BW = 8 MHz and Meas Type = Power spectral density reference	n = 3	<p>Returns 28 scalar values of the pass/fail (0 = passed, or 1 = failed) determined by testing the relative to the reference carrier and by testing the absolute power limit of the offset frequencies (measured as power spectral density in dB):</p> <ol style="list-style-type: none"> 1. Lower offset A - relative limit result 2. Lower offset A - absolute limit result 3. Upper offset A - relative limit result 4. Upper offset A - absolute limit result 5. Lower offset B - relative limit result 6. Lower offset B - absolute limit result 7. Upper offset B - relative limit result

Condition	N	Results Returned
		8. Upper offset B - absolute limit result ... 21. Lower offset F - relative limit result 22. Lower offset F - absolute limit result 23. Upper offset F - relative limit result 24. Upper offset F - absolute limit result 25. -999.0 26. -999.0 27. -999.0 28. -999.0 The last four results always returned -999.0.
Meas Type = Total power reference	n = 3	Returns 24 scalar values of the pass/fail (0 = passed, or 1 = failed) determined by testing the relative to the reference carrier and by testing the absolute power limit of the offset frequencies (measured as total power in dB): 1. Lower offset A - relative limit result 2. Lower offset A - absolute limit result 3. Upper offset A - relative limit result 4. Upper offset A - absolute limit result 5. Lower offset B - relative limit result 6. Lower offset B - absolute limit result 7. Upper offset B - relative limit result 8. Upper offset B - absolute limit result ... 21 Lower offset F - relative limit result 22 Lower offset F - absolute limit result 23 Upper offset F - relative limit result 24 Upper offset F - absolute limit result When in MSR and LTE-Advanced FDD/TDD, this trace includes only outer offset results.
Meas Type = Power spectral density reference	n = 3	Returns 24 scalar values of the pass/fail (0 = passed, or 1 = failed) determined by testing the relative to the reference carrier and by testing the absolute power limit of the offset frequencies (measured as power spectral density in dB): 1. Lower offset A - relative limit result 2. Lower offset A - absolute limit result 3. Upper offset A - relative limit result 4. Upper offset A - absolute limit result 5. Lower offset B - relative limit result 6. Lower offset B - absolute limit result 7. Upper offset B - relative limit result 8. Upper offset B - absolute limit result

Condition	N	Results Returned
		<p>...</p> <p>21 Lower offset F - relative limit result</p> <p>22 Lower offset F - absolute limit result</p> <p>23 Upper offset F - relative limit result</p> <p>24 Upper offset F - absolute limit result</p> <p>When in MSR and LTE-Advanced FDD/TDD, this trace includes only outer offset results.</p>
	n = 4	Returns <Num Pts> comma-separated scalar values representing the Y values in Trace 1
	n = 5	Returns <Num Pts> comma-separated scalar values representing the Y values in Trace 2
	n = 6	Returns <Num Pts> comma-separated scalar values representing the Y values in Trace 3
Meas Type = Total power reference	n = 7	<p>Returns (2 * Number of Carriers) scalar results, in the following order:</p> <p>The Number of Carriers is the value filled in Carriers under Carrier Setup menu. If license N9060A-5FP is enabled, max value of Number of Carriers is 18, otherwise, max value of Number of Carriers is 12. In MSR mode, max value of Number of Carriers is 100. In LTE-Advanced FDD/TDD mode, max value of number of carriers is 5.</p> <ol style="list-style-type: none"> 1. Channel (1) - relative power (dB) 2. Channel (1) - absolute power (dBm) 3. Channel (2) - relative power (dB) 4. Channel (2) - absolute power (dBm) <p>...</p> <p>2 * Number of Carriers -1. Channel (Number of Carriers) - relative power (dB)</p> <p>2 * Number of Carriers. Channel (Number of Carriers) - absolute power (dBm)</p> <p>If the results are not available, 9.91E+37 is returned.</p>
Meas Type = Power spectral density reference	n = 7	<p>Returns (2 * Number of Carriers) scalar results, in the following order: The Number of Carriers is the value filled in Carriers under Carrier Setup menu.</p> <p>If license N9060A-5FP is enabled, max value of Number of Carriers is 18, otherwise, max value of Number of Carriers is 12. In MSR mode, max value of Number of Carriers is 100. In LTE-Advanced FDD/TDD mode, max value of number of carriers is 5.</p> <ol style="list-style-type: none"> 1. Channel (1) - relative power (dB) 2. Channel (1) - absolute power (dBm/Hz or dBm/MHz) 3. Channel (2) - relative power (dB) 4. Channel (2) - absolute power (dBm/Hz or dBm/MHz) <p>...</p> <p>2 * Number of Carriers -1. Channel (Number of Carriers) - relative power (dB)</p> <p>2 * Number of Carriers. Channel (Number of Carriers) - absolute power (dBm/Hz or dBm/MHz)</p>

Condition	N	Results Returned
		If the results are not available, 9.91E+37 is returned
Mode = MSR,LTEAFDD,LTEATDD	n = 8	<p>Returns scalar results, in the following order:</p> <ol style="list-style-type: none"> 0.0 Total carrier power (dBm) 0.0 Reference carrier power (dBm, dBm/Hz or dBm/MHz) Inner Lower offset A - relative power (dB) Inner Lower offset A - absolute power (dBm, dBm/Hz or dBm/MHz) Inner Upper offset A - relative power (dB) Inner Upper offset A - absolute power (dBm, dBm/Hz or dBm/MHz) Inner Lower offset B - relative power (dB) Inner Lower offset B - absolute power (dBm, dBm/Hz or dBm/MHz) Inner Upper offset B - relative power (dB) Inner Upper offset B - absolute power (dBm, dBm/Hz or dBm/MHz) <p>...</p> <ol style="list-style-type: none"> Inner Lower offset F - relative power (dB) Inner Lower offset F - absolute power (dBm, dBm/Hz or dBm/MHz) Inner Upper offset F - relative power (dB) Inner Upper offset F - absolute power (dBm, dBm/Hz or dBm/MHz) <p>When Power Ref is either Left & Right Carriers or Max Power Carrier in Sub-block, the first four values are</p> <ol style="list-style-type: none"> 0.0 Total carrier power (dBm) Reference carrier in the lower sub-block (dBm, dBm/Hz or dBm/MHz) Reference carrier in the upper sub-block (dBm, dBm/Hz or dBm/MHz) <p>Unit of absolute power results. dBm: Meas Type = Total Pwr Ref dBm/Hz: Meas Type = PSD Ref, PSD Unit = dBm/Hz dBm/MHz: Meas Type = PSD Ref, PSD Unit = dBm/MHz</p> <p>If the results are not available, 9.91E+37 is returned.</p>
Mode = MSR, LTEAFDD,LTEATDD	n = 9	<p>Returns scalar values of the pass/fail (0 = passed, or 1 = failed) determined by testing the relative to the reference carrier and by testing the absolute power limit of the offset frequencies.</p> <ol style="list-style-type: none"> Inner Lower offset A - relative limit result Inner Lower offset A - absolute limit result Inner Upper offset A - relative limit result Inner Upper offset A - absolute limit result Inner Lower offset B - relative limit result Inner Lower offset B - absolute limit result

Condition	N	Results Returned
		7. Inner Upper offset B - relative limit result 8. Inner Upper offset B - absolute limit result ... 21. Inner Lower offset F - relative limit result 22. Inner Lower offset F - absolute limit result 23. Inner Upper offset F - relative limit result 24. Inner Upper offset F - absolute limit result
Mode = MSR, LTEAFDD,LTEATDD	n = 10	Returns scalar values of offset results. Numbers returned in this trace is 10 x actually measured offsets. Note that upper and lower sides of an offset are returned separately. For example, when only outer offset A is measured with offset side both, $10 \times 2 = 20$ values are returned. 1. Inner = 1 or Outer = 2. 2. Offset A~F. (A=1, B=2, ... F=6) 3. Offset Side. Lower=1 or Upper=2 4. Relative power or relative PSD (dBc or dB) 5. Absolute power (dBm) or absolute PSD (dBm/Hz or dBm/MHz) 6. Reference power (dBm) or reference PSD (dBm/Hz or dBm/MHz) 7. Reference Index 1 8. Reference Index 2 9. 0 (Reserved) 10. 0 (Reserved) ... 10(n-1)+1. Inner = 1 or Outer = 2. 10(n-1)+2. Offset A~F. (A=1, B=2, ... F=6) 10(n-1)+3. Offset Side. Lower=1 or Upper=2 10(n-1)+4. Relative power or relative PSD (dBc or dB) 10(n-1)+5. Absolute power (dBm) or absolute PSD (dBm/Hz or dBm/MHz) 10(n-1)+6. Reference power (dBm) or reference PSD (dBm/Hz or dBm/MHz) 10(n-1)+7. Reference Index 1 10(n-1)+8. Reference Index 2 10(n-1)+9. 0 (Reserved) 10(n-1)+10. 0 (Reserved) Where n is number of offsets. Meas Type determines which type of power result is returned, i.e. power or PSD. Unit for PSD results is determined by PSD Unit. If result is not available, 9.91E+37 is returned.

Key Path	Front-panel key
Initial S/W Revision	Prior to A.02.00
Modified at S/W Revision	A.13.00

AMPTD Y Scale

Accesses a menu of functions that enable you to set the vertical scale parameters. The parameter values are measurement independent, except all Attenuation values and the Internal Preamp selections, which are the same across all measurements.

Key Path	Front-panel key
Initial S/W Revision	Prior to A.02.00

Ref Value

Sets the value for the absolute power reference. However, since the Auto Scaling is defaulted to On, this value is automatically determined by the measurement result. When you set a value manually, Auto Scaling automatically changes to Off.

Key Path	AMPTD Y Scale
Mode	SA, WCDMA, C2K, WIMAX OFDMA, TD-SCDMA, 1xEVDO, DVB-T/H, DTMB (CTTB), ISDB-T, CMMB, LTE, LTE-TDD, Digital Cable TV, MSR, LTEAFDD, LTEATDD
Remote Command	:DISPlay:ACP:Power:VIEW[1]:WINDow[1]:TRACe:Y[:SCALe]:RLEVel <real> :DISPlay:ACP:Power:VIEW[1]:WINDow[1]:TRACe:Y[:SCALe]:RLEVel?
Example	DISP:ACP:VIEW:WIND:TRAC:Y:RLEV 100 DISP:ACP:VIEW:WIND:TRAC:Y:RLEV?
Notes	You must be in the mode that includes ACP measurements to use this command. Use :INSTrument:SElect to set the mode.
Couplings	When the Auto Scaling is On, this value is automatically determined by the measurement result. When you set a value manually, Auto Scaling automatically changes to Off.
Preset	10dBm
State Saved	Saved in instrument state.
Min	-250.00 dBm
Max	250.00 dBm
Initial S/W Revision	Prior to A.02.00
Modified at S/W Revision	A.02.00, A.03.00

Range

The Range menu allows setting amplitude controls of the instrument.

Key Path	AMPTD Y Scale
Scope	Meas Global
Initial S/W Revision	A.12.50

Range

Represents the amplitude of the largest sinusoidal signal that could be present within the IF without being clipped by the ADC. For signals with high peak-to-average ratios, the range may need to exceed the rms signal power by a fair amount to avoid clipping.

Key Path	Range
Mode	BASIC
Remote Command	<code>[:SENSe]:POWer[:RF]:RANGe <real></code> <code>[:SENSe]:POWer[:RF]:RANGe?</code>
Example	<code>:POW:RANG 10.0</code> <code>:POW:RANG?</code>
Notes	The MIN and MAX values are affected by the External Gain parameters, and by the Center Frequency. (The hardware compensates for frequency response and alters the Range setting.)
Preset	0
State Saved	Saved in instrument state.
Min	-100
Max	100
Initial S/W Revision	A.12.50

Adjust Range For Min Clip

Sets the combination of attenuation and gain based on the current measured signal level so that clipping will be at a minimum.

This is an "immediate action" function, that is, it executes once, when the key is pressed.

This key is grayed out in measurements that do not support this functionality.

Key Path	AMPTD Y Scale, Attenuation
Remote Command	<code>[:SENSe]:POWer[:RF]:RANGe:OPTimize IMMEDIATE</code>
Initial S/W Revision	Prior to A.02.00
Modified at S/W Revision	A.03.00

Pre-Adjust for Min Clip

If this function is on, it does the adjustment described under Adjust Range For Min Clip each time a measurement restarts. Therefore, in Continuous measurement mode, it only executes before the first measurement.

Key Path	AMPTD Y Scale, Attenuation
Remote Command	<code>[:SENSe]:POWer[:RF]:RANGe:OPTimize:ATTenuation OFF ON ELEctrical COMBined</code>

	<code>[:SENSe]:POWer[:RF]:RANGe:OPTimize:ATTenuation?</code>
Notes	This parameter is shared with old XA platform which uses AutoAtten. To keep the backward compatibility, ELECTRical and COMBined still can be used. Then, upon receiving ELECTRical and COMBined, these enums will be interpreted as aliases of ON. Then, when queried, ON will be returned.
Preset	OFF for Swept SA measurement; ON for all other measurements that support Pre-Adjust for Min Clip
State Saved	Saved in instrument state
Initial S/W Revision	Prior to A.02.00
Modified at S/W Revision	A.03.00

Peak to Average

The Peak to Average Ratio is used with the Range setting to optimize the level control in the instrument. The value is the ratio, in dB, of the peak power to the average power of the signal to be measured. A ratio of 0 should be used for sinusoidal signals; for 802.11g OFDM signals use 9 dB.

All Applications (Modes) will show the current value of Peak to Average ratio on the softkey. However, some applications will not permit changing the value. In these situations the softkey will be grayed-out.

Key Path	AMPTD Y Scale, Range
Remote Command	<code>[:SENSe]:POWer[:RF]:RANGe:PARatio <real></code> <code>[:SENSe]:POWer[:RF]:RANGe:PARatio?</code>
Example	POW:RANG:PAR 12 dB
Notes	In some Applications (Modes) this parameter will be read-only; meaning the value will appear on the softkey and query via SCPI, but not changeable. In such applications the softkey will be grayed-out. Attempting to change the value via SCPI will be ignored and no error message will be generated.
Preset	10 dB
State Saved	Saved in instrument state
Min	0 dB
Max	20 dB
Initial S/W Revision	A.13.00

Mixer Level Offset

Mixer level offset is an advanced setting to adjust target Range at the input mixer which in turn affects the signal level in the instrument's IF. This setting can be used when additional optimization is needed after setting Peak to Average ratio. Positive values of offset optimize noise performance over distortion, negative values optimize distortion performance over noise.

Key Path	AMPTD Y Scale, Range
Remote Command	<code>[:SENSe]:POWer[:RF]:RANGe:MIXer:OFFSet <real></code>

	<code>[:SENSe] :POWeR [:RF] :RANGe :MIXer :OFFSet ?</code>
Example	<code>POW:RANG:MIX:OFFS -5 dB</code>
Preset	0 dB
State Saved	Saved in instrument state
Min	-35 dB
Max	30 dB
Initial S/W Revision	A.13.00

Scale/Div

Sets the units-per-division of the vertical scale in the logarithmic display. However, since the Auto Scaling is defaulted to On, this value is automatically determined by the measurement result. When you set a value manually, Auto Scaling automatically changes to Off.

Key Path	AMPTD Y Scale
Mode	SA, WCDMA, C2K, WIMAX OFDMA, TD-SCDMA, 1xEVDO, DVB-T/H, DTMB (CTTB), ISDB-T, CMMB, LTE, LTE-TDD, Digital Cable TV, MSR, LTEAFDD, LTEATDD
Remote Command	<code>:DISPlay:ACPower:VIEW[1]:WINDow[1]:TRACe:Y[:SCALe]:PDIVision <rel_ampl></code> <code>:DISPlay:ACPower:VIEW[1]:WINDow[1]:TRACe:Y[:SCALe]:PDIVision?</code>
Example	<code>DISP:ACP:VIEW:WIND:TRAC:Y:PDIV 5</code> <code>DISP:ACP:VIEW:WIND:TRAC:Y:PDIV?</code>
Notes	You must be in the mode that includes ACP measurements to use this command. Use <code>:INSTrument:SElect</code> to set the mode.
Couplings	When the Auto Scaling is On, this value is automatically determined by the measurement result. When you set a value manually, Auto Scaling automatically changes to Off.
Preset	10.00 dB
State Saved	Saved in instrument state.
Min	0.10 dB
Max	20.00 dB
Initial S/W Revision	Prior to A.02.00
Modified at S/W Revision	A.02.00, A.03.00

Ref Position

Positions the reference level at the top, center, or bottom of the Y- scale display. Changing the reference position does not change the reference level value.

Key Path	AMPTD Y Scale
Mode	SA, WCDMA, C2K, WIMAX OFDMA, TD-SCDMA, 1xEVDO, DVB-T/H, DTMB (CTTB), ISDB-T, CMMB, LTE, LTE-TDD, Digital Cable TV, MSR, LTEAFDD, LTEATDD

Remote Command	:DISPlay:ACPower:VIEW[1]:WINDow[1]:TRACe:Y[:SCALe]:RPOSition TOP CENTER BOTTom :DISPlay:ACPower:VIEW[1]:WINDow[1]:TRACe:Y[:SCALe]:RPOSition?
Example	DISP:ACP:VIEW:WIND:TRAC:Y:RPOS CENT DISP:ACP:VIEW:WIND:TRAC:Y:RPOS?
Notes	You must be in the mode that includes ACP measurements to use this command. Use :INSTrument:SElect to set the mode.
Preset	TOP
State Saved	Saved in instrument state.
Range	Top Ctr Bot
Initial S/W Revision	Prior to A.02.00
Modified at S/W Revision	A.02.00, A.03.00

Auto Scaling

Toggles the Auto Scaling function between On and Off.

Key Path	AMPTD Y Scale
Mode	SA, WCDMA, C2K, WIMAX OFDMA, TD-SCDMA, 1xEVDO, DVB-T/H, DTMB (CTTB), ISDB-T, CMMB, LTE, LTEFDD, Digital Cable TV, MSR, LTEAFDD, LTEATDD
Remote Command	:DISPlay:ACPower:VIEW[1]:WINDow[1]:TRACe:Y[:SCALe]:COUPle 0 1 OFF ON :DISPlay:ACPower:VIEW[1]:WINDow[1]:TRACe:Y[:SCALe]:COUPle?
Example	DISP:ACP:VIEW:WIND:TRAC:Y:COUP ON DISP:ACP:VIEW:WIND:TRAC:Y:COUP?
Notes	You must be in the mode that includes ACP measurements to use this command. Use :INSTrument:SElect to set the mode.
Couplings	When Auto Scaling is On and the Restart front-panel key is pressed, this function automatically determines the scale per division and reference values based on the measurement results. When you set a value to either Scale/Div or Ref Value manually, Auto Scaling automatically changes to Off.
Preset	ON
State Saved	Saved in instrument state.
Range	On Off
Initial S/W Revision	Prior to A.02.00
Modified at S/W Revision	A.02.00, A.03.00

Auto Couple

The Auto Couple feature provides a quick and convenient way to automatically couple multiple instrument settings. This helps ensure accurate measurements and optimum dynamic range. When the Auto Couple feature is activated, either from the front panel or remotely, all parameters of the current measurement that have an Auto/Manual mode are set to Auto mode and all measurement settings dependent on (or coupled to) the Auto/Man parameters are automatically adjusted for optimal performance.

However, the Auto Couple key actions are confined to the current measurement only. It does not affect other measurements in the mode, and it does not affect markers, marker functions, or trace or display attributes.

See "[More Information](#)" on page 570

Key Path	Front-panel key
Remote Command	:COUPle ALL NONE
Example	:COUP ALL
Notes	:COUPle ALL puts all Auto/Man parameters in Auto mode (equivalent to pressing the Auto Couple key). :COUPLE NONE puts all Auto/Man parameters in manual mode. It decouples all the coupled instrument parameters and is not recommended for making measurements.
Initial S/W Revision	Prior to A.02.00

More Information

There are two types of functions that have Auto/Manual modes.

Auto/Man Active Function keys

An Auto/Man toggle key controls the binary state associated with an instrument parameter by toggling between Auto (where the parameter is automatically coupled to the other parameters it is dependent upon) and Man (where the parameter is controlled independent of the other parameters), as well as making the parameter the active function. The current mode is indicated on the softkey with either Auto or Man underlined as illustrated below.

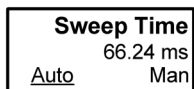

vsd07

Auto/Man 1-of-N keys

An Auto/Man 1-of-N key allows you to manually pick from a list of parameter values, or place the function in Auto, in which case the value is automatically selected (and indicated) as shown below. If in Auto, Auto is underlined on the calling key. If in manual operation, manual is indicated on the calling key. But the calling key does not actually toggle the function, it simply opens the menu.

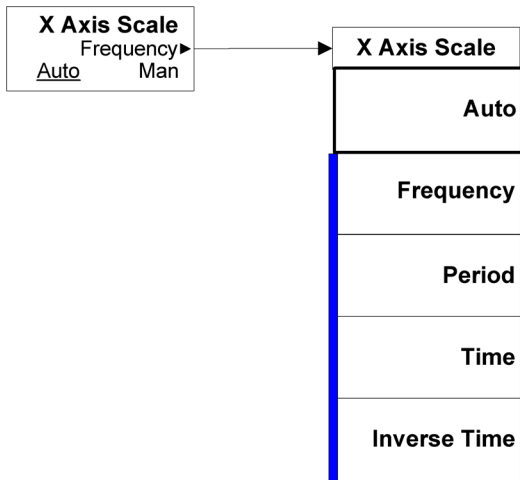

vsd08

BW

Accesses a menu of functions that enable you to specify and control the video and resolution bandwidths. You can also select the type of filter for the measurement and set the filter bandwidth.

Key Path	Front-panel key
Initial S/W Revision	Prior to A.02.00

Res BW

Sets the value of the resolution bandwidth. If an unavailable bandwidth is entered with the numeric keypad, the closest available bandwidth is selected.

LTE-Advanced FDD/TDD Auto RBW:

Bandwidth	RBW (KHz)
1.4MHz	51KHz
3MHz	
5MHz	100 KHz
10MHz	
15MHz	
20MHz	

the resolution bandwidth is predefined based on the corresponding bandwidth of the single LTE carrier, which is listed above. When ResBW mode is Auto, the narrowest RBW over the active carriers is selected for Multi-carriers.

Key Path	BW
Mode	SA, WCDMA, C2K, WIMAX OFDMA, TD-SCDMA, 1xEVDO, DVB-T/H, DTMB (CTTB), ISDB-T, CMMB, LTE, LTE-TDD, Digital Cable TV, MSR, LTEAFDD, LTEATDD
Remote Command	[:SENSe]:ACPower:BANDwidth[:RESolution] <freq> [:SENSe]:ACPower:BANDwidth[:RESolution]? [:SENSe]:ACPower:BANDwidth[:RESolution]:AUTO ON OFF 1 0 [:SENSe]:ACPower:BANDwidth[:RESolution]:AUTO?
Example	ACP:BAND 25kHz ACP:BAND? ACP:BAND:AUTO ON ACP:BAND:AUTO?
Notes	This key is available only in IBW mode. This parameter is preset by the Meas Method selection. Preset values are as follows: IBW: 100 kHz

	IBWR: 27 kHz FAST (WCDMA): 390 kHz You must be in the mode that includes ACP measurements to use this command. Use :INSTrument:SElect to set the mode.
Dependencies	When Meas Method is RBW or FAST, this key is grayed out and disabled. If the key is pressed, an advisory message is generated. If the equivalent remote command is sent, a "Setting conflict" warning is generated.
Couplings	The resolution bandwidth is coupled to the video bandwidth based on the video to resolution bandwidth ratio setting if AUTO is selected.
Preset	SA: 220 kHz WCDMA: 100 kHz WIMAX OFDMA: 100 kHz C2K: 15 kHz TD-SCDMA: 30 kHz 1xEVDO: 30 kHz DVB-T/H: 39 kHz DTMB (CTTB): 39 kHz ISDB-T: 39 kHz CMMB: 39 kHz LTE: 100 kHz LTETDD: 100 kHz Digital Cable TV: 39 kHz MSR: 100 kHz LTEAFDD, LTEATDD: 100kHz LTE, LTETDD, LTEAFDD, LTEATDD: 1 Others:0
State Saved	Saved in instrument state.
Min	1 Hz
Max	8 MHz
Backwards Compatibility SCPI	[:SENSe] :ACP:Power:BWIDth [:RESolution] [:SENSe] :ACP:SWEp:Bandwidth BWIDth [:RESolution] (PSA W-CDMA, PSA cdma2000)
Initial S/W Revision	Prior to A.02.00
Modified at S/W Revision	A.02.00, A.03.00

Video BW

Changes the analyzer post-detection filter (VBW).

Key Path	BW
Mode	SA, WCDMA, C2K, WIMAX OFDMA, TD-SCDMA, 1xEVDO, DVB-T/H, DTMB (CTTB), ISDB-T, CMMB,

	LTE, LTETDD, Digital Cable TV, MSR, LTEAFDD, LTEATDD
Remote Command	[:SENSe]:ACPower:BANDwidth:VIDeo <freq> [:SENSe]:ACPower:BANDwidth:VIDeo? [:SENSe]:ACPower:BANDwidth:VIDeo:AUTO OFF ON 0 1 [:SENSe]:ACPower:BANDwidth:VIDeo:AUTO?
Example	ACP:BAND:VID 1kHz ACP:BAND:VID? ACP:BWID:VID:AUTO ON ACP:BWID:VID:AUTO?
Notes	The values shown in this table reflect the conditions after a Mode Preset.
Dependencies	When Meas Method is RBW or FAST, this key is grayed out and disabled. If the key is pressed, an advisory message is generated. If the equivalent remote command is sent, a "Setting conflict" warning is generated.
Preset	SA: 22 kHz WCDMA, WIMAX OFDMA: 1 MHz C2K: Method RBW: grayed out (1.2 MHz) Method IBW: 150 kHz TD-SCDMA: 300 kHz 1xEVDO: 300 kHz DVB-T/H: 390 kHz DTMB (CTTB): 390 kHz ISDB-T: 390 kHz CMMB: 390 kHz LTE, LTETDD, MSR: Auto LTETDD: 1 MHz Digital Cable TV: 390 kHz LTEAFDD, LTEATDD: Auto SA: ON WCDMA: OFF WIMAX OFDMA: OFF TD-SCDMA: OFF DVB-T/H: OFF DTMB (CTTB): OFF CDMA1xEVDO: OFF ISDB-T: OFF CMMB: OFF LTE, MSR: ON LTETDD: ON Digital Cable TV: OFF

	LTEAFDD, LTEATDD: ON
State Saved	Saved in instrument state.
Min	1 Hz
Max	50 MHz
Backwards Compatibility SCPI	[:SENSe] :ACPower :BWIDth :VIDeo
Initial S/W Revision	Prior to A.02.00
Modified at S/W Revision	A.02.00, A.03.00

RBW Control

Accesses a menu that enables you to select the filter bandwidth and type.

Key Path	BW
Initial S/W Revision	Prior to A.02.00

Filter Type

Selects the type of bandwidth filter that is used. The choices are Gaussian or Flat top.

Key Path	BW, RBW Control
Mode	SA, WCDMA, C2K, WIMAX OFDMA, TD-SCDMA, 1xEVDO, DVB-T/H, DTMB (CTTB), ISDB-T, CMMB, LTE, LTE-TDD, Digital Cable TV, MSR, LTEAFDD, LTEATDD
Remote Command	[:SENSe] :ACPower :BANDwidth :SHAPE GAUSSian FLATtop [:SENSe] :ACPower :BANDwidth :SHAPE?
Example	ACP:BAND:SHAP GAUS ACP:BAND:SHAP?
Dependencies	When Meas Method is FAST, this key is grayed out and disabled. If the key is pressed, an advisory message is generated. If the equivalent remote command is sent, a "Setting conflict" warning is generated.
Preset	GAUSSian C2K: FLATtop
State Saved	Saved in instrument state.
Range	Gaussian (Normal) Flattop
Backwards Compatibility SCPI	[:SENSe] :ACPower :BWIDth :SHAPE
Initial S/W Revision	Prior to A.02.00
Modified at S/W Revision	A.02.00, A.03.00

Filter BW

Selects a Gaussian filter based on its -3 dB (Normal) bandwidth or its -6 dB bandwidth.

Key Path	BW, RBW Control
Mode	SA, WCDMA, C2K, WIMAX OFDMA, TD-SCDMA, 1xEVDO, DVB-T/H, DTMB (CTTB), ISDB-T, CMMB, LTE, LTEFDD, Digital Cable TV, MSR, LTEAFDD, LTEATDD
Remote Command	<code>[:SENSe] :ACPower :BANDwidth :TYPE DB3 DB6</code> <code>[:SENSe] :ACPower :BANDwidth :TYPE ?</code>
Example	ACP:BAND:TYPE DB3 ACP:BAND:TYPE?
Dependencies	When Filter Type is Flattop or Meas Method is RBW or FAST, this key is grayed out and disabled. If the key is pressed, an advisory message is generated. If the equivalent remote command is sent, a "Setting conflict" warning is generated.
Preset	DB3
State Saved	Saved in instrument state.
Range	-3 dB (Normal) -6 dB
Backwards Compatibility SCPI	<code>[:SENSe] :ACPower :BWIDth :TYPE</code>
Initial S/W Revision	Prior to A.02.00
Modified at S/W Revision	A.02.00, A.03.00

Cont (Continuous Measurement/Sweep)

Sets the analyzer for Continuous measurement operation. The single/continuous state is Meas Global so the setting will affect all measurements. If you are Paused, pressing Cont does a Resume.

Key Path	Front-panel key
Remote Command	:INITiate:CONTinuous OFF ON 0 1 :INITiate:CONTinuous?
Example	:INIT:CONT 0 puts analyzer in Single measurement operation. :INIT:CONT 1 puts analyzer in Continuous measurement operation
Preset	ON (Note that SYST:PRESet sets INIT:CONT to ON but *RST sets INIT:CONT to OFF)
State Saved	Saved in instrument state
Backwards Compatibility Notes	For Spectrum Analysis mode in ESA and PSA, there is no Cont hardkey, instead there is a Sweep Single/Cont key. In these analyzers, switching the Sweep Single/Cont key from Single to Cont restarts averages (displayed average count reset to 1), but does not restart Max Hold and Min Hold. The X-Series has Single and Cont keys in place of the SweepSingleCont key. In the X-Series, if in single measurement, the Cont key (and INIT:CONT ON) switches to continuous measurement, but never restarts a measurement and never resets a sweep.
Initial S/W Revision	Prior to A.02.00

In Swept SA Measurement (Spectrum Analysis Mode):

The analyzer takes repetitive sweeps, averages, measurements, etc., when in Continuous mode. When the average count reaches the Average/Hold Number the count stops incrementing, but the analyzer keeps sweeping. See the Trace/Detector section for the averaging formula used both before and after the Average/Hold Number is reached. The trigger condition must be met prior to each sweep. The type of trace processing for multiple sweeps, is set under the Trace/Detector key, with choices of Trace Average, Max Hold, or Min Hold.

In Other Measurements/Modes:

With Avg/Hold Num (in the Meas Setup menu) set to Off or set to On with a value of 1, a sweep is taken after the trigger condition is met; and the analyzer continues to take new sweeps after the current sweep has completed and the trigger condition is again met. However, with Avg/Hold Num set to On with a value >1, multiple sweeps (data acquisitions) are taken for the measurement. The trigger condition must be met prior to each sweep. The sweep is not stopped when the average count k equals the number N set for Avg/Hold Num is reached, but the number k stops incrementing. A measurement average usually applies to all traces, marker results, and numeric results. But sometimes it only applies to the numeric results.

If the analyzer is in Single measurement, pressing the Cont key does not change k and does not cause the sweep to be reset; the only action is to put the analyzer into Continuous measurement operation.

If it is already in continuous sweep:

the INIT:CONT 1 command has no effect

9 ACP Measurement
Cont (Continuous Measurement/Sweep)

the INIT:CONT 0 command will place the analyzer in Single Sweep but will have no effect on the current sequence until $k = N$, at which point the current sequence will stop and the instrument will go to the idle state.

File

See "File" on page 184

FREQ Channel

Accesses a menu of keys that allow you to control the Frequency and Channel parameters of the instrument.

Some features in the Frequency menu are the same for all measurements – they do not change as you change measurements. Settings like these are called “Meas Global” and are unaffected by Meas Preset. For example, the Center Freq setting is the same for all measurements - it does not change as you change measurements.

Key Path	Front-panel key
Initial S/W Revision	Prior to A.02.00

Center Freq

Sets the frequency that corresponds to the horizontal center of the graticule (when frequency Scale Type is set to linear). While adjusting the Center Frequency the Span is held constant, which means that both Start Frequency and Stop Frequency will change.

Pressing Center Freq also sets the frequency entry mode to Center/Span. In Center/Span mode, the center frequency and span values are displayed below the graticule, and the default active function in the Frequency menu is Center Freq.

The center frequency setting is the same for all measurements within a mode, that is, it is Meas Global. Some modes are also able to share a Mode Global center frequency value. If this is the case, the Mode will have a Global Settings key in its Mode Setup menu.

The Center Freq function sets (and queries) the Center Frequency for the currently selected input. If your analyzer has multiple inputs, and you select another input, the Center Freq changes to the value for that input. SCPI commands are available to directly set the Center Freq for a specific input.

Center Freq is remembered as you go from input to input. Thus you can set a Center Freq of 10 GHz with the RF Input selected, change to BBIQ and set a Center Freq of 20 MHz, then switch to External Mixing and set a Center Freq of 60 GHz, and when you go back to the RF Input the Center Freq will go back to 10 GHz; back to BBIQ and it is 20 MHz; back to External Mixing and it is 60 GHz.

See ["RF Center Freq" on page 583](#)

See [Ext Mix Center Freq](#)

See ["I/Q Center Freq" on page 585](#)

See ["Center Frequency Presets" on page 581](#)

Key Path	FREQ Channel
Scope	Meas Global
Remote Command	<code>[:SENSe] :FREQuency:CENTer <freq></code> <code>[:SENSe] :FREQuency:CENTer?</code>
Example	<code>FREQ:CENT 50 MHz</code>

	FREQ:CENT UP changes the center frequency to 150 MHz if you use FREQ:CENT:STEP 100 MHz to set the center frequency step size to 100 MHz FREQ:CENT?
Notes	This command sets either the RF or I/Q Center Frequency depending on the selected input. For RF input it is equivalent to FREQ:RF:CENT For I/Q input it is equivalent to FREQ:IQ:CENT Preset and Max values are dependent on Hardware Options (5xx) If no terminator (e.g. MHz) is sent the terminator Hz is used. If a terminator with unit other than Frequency is used, an invalid suffix error message is generated.
Dependencies	The Center Frequency can be limited by Start or Stop Freq limits, if the Span is so large that Start or Stop reach their limit.
Couplings	When operating in "swept span", any value of the Center Frequency or Span that is within the frequency range of the analyzer is allowed when the value is being set through the front panel numeric key pad or the SCPI command. The other parameter is forced to a different value if needed, to keep the Start and the Stop Frequencies within the analyzer's frequency range
Preset	Depends on instrument maximum frequency, mode, measurement, and selected input. See "Center Frequency Presets" on page 581 and "RF Center Freq" on page 583 and Ext Mix Center Freq and "I/Q Center Freq" on page 585.
State Saved	Saved in instrument state
Min	Depends on instrument maximum frequency, mode, measurement, and selected input.. See "Center Frequency Presets" on page 581 and "RF Center Freq" on page 583 and "I/Q Center Freq" on page 585.
Max	Depends on instrument maximum frequency, mode, measurement, and selected input.. See "Center Frequency Presets" on page 581 and "RF Center Freq" on page 583 and "I/Q Center Freq" on page 585.
Default Unit	Hz
Status Bits/OPC	Non-overlapped
Dependencies	
Initial S/W Revision	Prior to A.02.00

Center Frequency Presets

The following table provides the Center Frequency Presets for the Spectrum Analyzer mode, and the Max Freq, for the various frequency options:

Freq Option	CF after Mode Preset	Stop Freq after Mode Preset	Max Freq (can't tune above)

9 ACP Measurement
FREQ Channel

503 (all but N9000A)	1.805 GHz	3.6 GHz	3.7 GHz
503 (N9000A)	1.505 GHz	3.0 GHz	3.08 GHz
504 (M9420A)	1 GHz	3.8GHz	3.88 GHz
506 (M9420A)	1 GHz	6.0GHz	6.08 GHz
507 (all but N9000A)	3.505 GHz	7.0 GHz	7.1 GHz
507 (N9000A)	3.755 GHz	7.5 GHz	7.58 GHz
508 (all but N9038A)	1.805 GHz	3.6 GHz	8.5 GHz
508 (N9038A)	4.205 GHz	8.4 GHz	8.5 GHz
513	6.805 GHz	13.6 GHz	13.8 GHz
526 (all but N9000A and N9038A)	13.255 GHz	26.5 GHz	27.0 GHz
526 (N9000A)	13.255 GHz	26.5 GHz	26.55 GHz
526 (N9038A)	1.805 GHz	3.6 GHz	27.0 GHz
532	16.005 GHz	32.0 GHz	32.5 GHz
543	21.505 GHz	43.0 GHz	TBD
544	22.005 GHz	44.0 GHz	44.5 GHz
550	25.005 GHz	50.0 GHz	51 GHz

Input 2:

Model	CF after Mode Preset	Stop Freq after Mode Preset	Max Freq (can't tune above)
N9000A opt C75	0.7505GHz	1.5 GHz	1.58 GHz
N9038A	505 MHz	1 GHz	1.000025 GHz

Tracking Generator Frequency Limits (N9000A only):

Tracking Generator Option	Min Freq (clips to this freq when turn TG on and can't tune below while TG on)	If above this Freq, Stop Freq clipped to this Freq when TG turned on	Max Freq (can't tune above) while TG on
T03	9 kHz	3.0 GHz	3.08 GHz
T06	9 kHz	6.0 GHz	6.05 GHz

The following table shows the Center Frequency Presets for modes other than Spectrum Analyzer:

Mode	CF Preset for RF
WCDMA	1 GHz
WIMAXOFDMA,	1 GHz
BASIC	1 GHz
ADEMOD	1 GHz
VSA	1 GHz
TDSCDMA	1 GHz
PNOISE	1 GHz
LTE	1 GHz
LTETDD	1 GHz
MSR	1 GHz
GSM	935.2 MHz
NFIGURE	1.505 GHz

RF Center Freq

SCPI command for specifying the RF Center Frequency. This command will set the Center Frequency to be used when the RF input is selected, even if the RF input is not the input that is selected at the time the command is sent. Note that the Center Freq function in the Frequency menu on the front panel always applies to the currently selected input.

Scope	Meas Global
Remote Command	<code>[:SENSe] :FREQuency:RF:CENTer <freq></code> <code>[:SENSe] :FREQuency:RF:CENTer?</code>
Example	FREQ:RF:CENT 30 MHz
Notes	This command is the same in all modes, but the parameter is Measurement Global. So the value is independent in each mode and common across all the measurements in the mode.
Dependencies	If the electronic/soft attenuator is enabled, any attempt to set Center Frequency such that the Stop Frequency would be >3.6 GHz fails and results in an advisory message. If the equivalent SCPI

	command is sent, this same message is generated as part of a “-221, Settings conflict” warning. If Source Mode is set to Tracking, and the Max or Min Center Freq is therefore limited by the limits of the source, a warning message is generated, “Data out of range;clipped to source max/min” if these limits are exceeded. Note that for an external source, these limits can be affected by the settings of Source Numerator, Source Denominator and Power Sweep.
Preset	See table above
State Saved	Saved in instrument state.
Min	-79.999995 MHz, unless Source Mode is set to Tracking, in which case it is limited by the minimum frequency of the Source
Max	See table above. Basically instrument maximum frequency – 5 Hz. Note that, if the Source Mode is set to Tracking, the effective instrument maximum frequency may be limited by the source maximum frequency. If the knob or step keys are being used, also depends on the value of the other three interdependent parameters Span, Start Frequency and Stop Frequency
Initial S/W Revision	Prior to A.02.00
Modified at S/W Revision	A.03.00

Ext Mix Center Freq

SCPI command for specifying the External Mixer Center Frequency. This command will set the Center Frequency to be used when the External Mixer is selected, even if the External Mixer input is not the input which is selected at the time the command is sent. Note that the Center Freq function in the Frequency menu on the front panel always applies to the currently selected input.

Scope	Meas Global
Remote Command	<code>[:SENSE] :FREQuency:EMIXer:CENTer <freq></code> <code>[:SENSE] :FREQuency:EMIXer:CENTer?</code>
Example	<code>:FREQ:EMIX:CENT 60 GHz</code> <code>:FREQ:EMIX:CENT?</code>
Notes	This command is the same in all modes, but the parameter is Measurement Global. So the value is independent in each mode and common across all the measurements in the mode.
Couplings	When returning to External Mixing after having been switched to one of the other inputs (e.g., RF), you will come back into the settings that you had when you left External Mixing. So you will come back to the band you were in with the Center Frequency that you had. However, Span is not an input-dependent parameter, therefore you will bring the span over from the other input. Therefore, the analyzer comes back with the span from the previous input, limited as necessary by the current mixer setup.
Preset	When a Mode Preset is performed while in External Mixing, the Start frequency of the current Mode is set to the nominal Min Freq of the lowest harmonic range in the Harmonic Table for the current mixer setup. Similarly, the Stop frequency of the current Mode is set to the nominal Max Freq of the highest harmonic range in the Harmonic Table. The Center Freq thus presets to the point arithmetically equidistant from these two frequencies.

If the current measurement has a limited Span available to it, and cannot achieve the Span shown in the table (Span=Stop Freq - Start Freq), the analyzer uses the maximum Span the measurement allows, and still sets the Center Freq to the midpoint of the Start and Stop Freq values in the Harmonic Table.

When Restore Input/Output Defaults is performed, the mixer presets to the 11970A, whose Start and Stop frequencies are 26.5 and 40 GHz respectively. The center of these two frequencies is 33.25 GHz.

Therefore, after a Restore Input/Output Defaults, if you go into External Mixing and do a Mode Preset while in the Spectrum Analyzer Mode, the resulting Center Freq is 33.25 GHz.

State Saved	Saved in instrument state.
Min	The minimum frequency in the currently selected mixer band + 5 Hz
Max	The maximum frequency in the currently selected mixer band - 5 Hz If the knob or step keys are being used, also depends on the value of the other three interdependent parameters Span, Start Frequency and Stop Frequency
Initial S/W Revision	A.08.01

I/Q Center Freq

SCPI command for specifying the I/Q Center Frequency. This command will set the Center Frequency to be used when the I/Q input is selected, even if the I/Q input is not the input which is selected at the time the command is sent. Note that the Center Freq function in the Frequency menu on the front panel always applies to the currently selected input.

Scope	Meas Global
Remote Command	[:SENSe] :FREQuency:IQ:CENTer <freq> [:SENSe] :FREQuency:IQ:CENTer?
Example	FREQ:IQ:CENT: 30 MHz
Notes	This command is the same in all modes, but the parameter is Measurement Global. So the value is independent in each mode and common across all the measurements in the mode.
Preset	0 Hz
State Saved	Saved in instrument state.
Min	-40.049995 MHz
Max	40.049995 MHz
Initial S/W Revision	Prior to A.02.00

CF Step

Changes the step size for the center frequency and start and stop frequency functions. Once a step size has been selected and the center frequency function is active, the step keys (and the UP|DOWN parameters for Center Frequency from remote commands) change the center frequency by the step-size value. The step size function is useful for finding harmonics and sidebands beyond the current frequency span of the analyzer.

Note that the start and stop frequencies also step by the CF Step value.

Key Path	FREQ Channel
Remote Command	[:SENSe]:FREQuency:CENTer:STEP[:INCRement] <freq> [:SENSe]:FREQuency:CENTer:STEP[:INCRement]? [:SENSe]:FREQuency:CENTer:STEP:AUTO OFF ON 0 1 [:SENSe]:FREQuency:CENTer:STEP:AUTO?
Example	FREQ:CENT:STEP:AUTO ON FREQ:CENT:STEP 500 MHz FREQ:CENT UP increases the current center frequency value by 500 MHz FREQ:CENT:STEP? FREQ:CENT:STEP:AUTO?
Notes	Preset and Max values are depending on Hardware Options (503, 507, 508, 513, 526)
Notes	Preset and Max values are dependent on Hardware Options (5xx)
Dependencies	Freq Offset is not available in External Mixing. In this case the Freq Offset key is grayed out and shows a value of zero. It will once again be available, and show the previously set value, when you return to the RF Input.
Dependencies	Span, RBW, Center frequency If the electronic/soft attenuator is enabled, any attempt to change the value of the center frequency >3.6 GHz by pressing the Up-arrow key, fails and results in an advisory message. If the equivalent SCPI command is sent, this same message is generated as part of a “-221, Settings conflict” warning.
Couplings	When auto-coupled in a non-zero span, the center frequency step size is set to 10% of the span. When auto-coupled in zero span, the center frequency step size is set to the equivalent -3 dB RBW value.
Preset	Auto ADEMOD: 1 MHz ON
State Saved	Saved in instrument state
Min	– (the maximum frequency of the instrument). That is, 27 GHz max freq instrument has a CF step range of +/- 27 GHz. Note that this is the maximum frequency given the current settings of the instrument, so in External Mixing, for example, it is the maximum frequency of the current mixer band.
Max	The maximum frequency of the instrument. That is, 27 GHz max freq instrument has a CF step range of +/- 27 GHz. Note that this is the maximum frequency given the current settings of the instrument, so in External Mixing, for example, it is the maximum frequency of the current mixer band.
Default Unit	Hz
Status Bits/OPC dependencies	non-overlapped
Initial S/W Revision	Prior to A.02.00
Modified at S/W Revision	A.03.00

Input/Output

See "[Input/Output](#)" on page 138

Marker

Accesses a menu that enables you to select, set up and control the markers for the current measurement. Note that this hard key and all sub keys are unavailable when "Meas Method" on page 651 is set to RBW.

Key Path	Front-panel key
Initial S/W Revision	Prior to A.02.00

Select Marker

Displays 12 markers available for selection. Note that this key is unavailable when "Meas Method" on page 651 is set to RBW.

Key Path	Marker
Initial S/W Revision	Prior to A.02.00

Marker Type

Sets the marker control mode to Normal, Delta, Fixed or Off. All interactions and dependencies detailed under the key description are enforced when the remote command is sent. If the selected marker is Off, pressing Marker sets it to Normal and places it at the center of the screen on the trace determined by the Marker Trace rules. At the same time, Marker X Axis Value appears on the Active Function area.

The default active function is the active function for the currently selected marker control mode. If the current control mode is Off, there is no active function and the active function is turned off.

Key Path	Marker
Mode	SA, WCDMA, C2K, WIMAX OFDMA, TD-SCDMA, 1xEVDO, DVB-T/H, DTMB (CTTB), ISDB-T, CMMB, LTE, LTE-TDD, Digital Cable TV, MSR, LTEAFDD, LTEATDD
Remote Command	:CALCulate:ACPower:MARKer[1] 2 ... 12:MODE POSition DELTa OFF :CALCulate:ACPower:MARKer[1] 2 ... 12:MODE?
Example	CALC:ACP:MARK2:MODE DELT CALC:ACP:MARK2:MODE?
Notes	If the selected marker is Off, pressing Marker sets it to Normal and places it at the center of the screen on the trace determined by the Marker Trace rules. At the same time, Marker X Axis Value appears on the Active Function area. Default Active Function: the active function for the selected marker's current control mode. If the current control mode is Off, there is no active function and the active function is turned off. Active Function Display: the marker X axis value entered in the active function area will display the marker value to its full entered precision. You must be in the mode that includes ACP measurements to use this command. Use :INSTrument:SElect to set the mode.
Dependencies	This key is unavailable when "Meas Method" on page 651 is set to RBW.

Preset	OFF OFF OFF OFF OFF OFF OFF OFF OFF OFF OFF OFF
State Saved	Saved in instrument state.
Range	Normal Delta Off
Initial S/W Revision	Prior to A.02.00
Modified at S/W Revision	A.02.00, A.03.00

Properties

Accesses the marker properties menu. Note that this key is unavailable when "Meas Method" on page 651 is set to RBW.

Key Path	Marker
Initial S/W Revision	Prior to A.02.00

Select Marker

Displays 12 markers available for selection. Note that this key is unavailable when "Meas Method" on page 651 is set to RBW.

Key Path	Marker
Initial S/W Revision	Prior to A.02.00

Relative To

Selects the desired marker. The selected marker will be relative to its reference marker.

Key Path	Marker, Properties
Mode	SA, WCDMA, C2K, WIMAX OFDMA, TD-SCDMA, 1xEVDO, DVB-T/H, DTMB (CTTB), ISDB-T, CMMB, LTE, LTETDD, Digital Cable TV, MSR, LTEAFDD, LTEATDD
Remote Command	:CALCulate:ACPpower:MARKer[1] 2 ... 12:REFerence <integer> :CALCulate:ACPpower:MARKer[1] 2 ... 12:REFerence?
Example	CALC:ACP:MARK2:REF 6 CALC:ACP:MARK2:REF?
Notes	A marker cannot be relative to itself so that choice is grayed out, and if sent from a remote command, generates error -221: "Settings conflict; marker cannot be relative to itself." When queried a single value will be returned (the specified marker numbers relative marker). You must be in the mode that includes ACP measurements to use this command. Use :INSTrument:SElect to set the mode.
Dependencies	This key is unavailable when "Meas Method" on page 651 is set to RBW.

Preset	2 3 4 5 6 7 8 9 10 11 12 1
State Saved	Saved in instrument state.
Min	1
Max	12
Initial S/W Revision	Prior to A.02.00
Modified at S/W Revision	A.02.00, A.03.00

Marker Trace

Selects the trace that you want your marker to be placed on. A marker is associated with one and only one trace. This trace is used to determine the placement, result, and X Axis Scale of the marker. All markers have an associated trace, even Fixed markers; it is from that trace that they determine their attributes and behaviors, and it is to that trace that they go when they become Normal or Delta markers.

Key Path	Marker, Properties
Mode	SA, WCDMA, C2K, WIMAX OFDMA, TD-SCDMA, 1xEVDO, DVB-T/H, DTMB (CTTB), ISDB-T, CMMB, LTE, LTE-TDD, Digital Cable TV, MSR, LTEAFDD, LTEATDD
Remote Command	:CALCulate:ACPower:MARKer[1] 2 ... 12:TRACe 1 2 3 :CALCulate:ACPower:MARKer[1] 2 ... 12:TRACe?
Example	CALC:ACP:MARK2:TRAC 2 CALC:ACP:MARK2:TRAC?
Notes	If the selected marker is Off, pressing Marker sets it to Normal and places it at the center of the screen on the trace determined by the Marker Trace rules. At the same time, Marker X Axis Value appears on the Active Function area. Default Active Function: the active function for the selected marker's current control mode. If the current control mode is Off, there is no active function and the active function is turned off. Active Function Display: the marker X axis value entered in the active function area will display the marker value to its full entered precision.
Dependencies	This key is unavailable when " Meas Method " on page 651 is set to RBW.
Couplings	This is not affected by Auto Coupling. Sending the remote command causes the addressed marker to become selected.
Preset	All Markers Off
State Saved	Saved in instrument state.
Range	1 2 3
Initial S/W Revision	Prior to A.02.00
Modified at S/W Revision	A.02.00, A.03.00

Couple Markers

When this function is On, moving any marker causes an equal X axis movement of every other marker which is not Off. By “equal X axis movement” we mean that we preserve the difference between each marker’s X axis value (in the fundamental x-axis units of the trace that marker is on) and the X axis value of the marker being moved (in the same fundamental x-axis units).

Key Path	Marker
Mode	SA, WCDMA, C2K, WIMAX OFDMA, TD-SCDMA, 1xEVDO, DVB-T/H, DTMB (CTTB), ISDB-T, CMMB, LTE, LTETDD, Digital Cable TV, MSR, LTEAFDD,LTEATDD
Remote Command	:CALCulate:ACPower:MARKer:COUPle[:STATe] ON OFF 1 0 :CALCulate:ACPower:MARKer:COUPle[:STATe]?
Example	CALC:ACP:MARK:COUP ON
Dependencies	This key is unavailable when "Meas Method" on page 651 is set to RBW.
Preset	OFF
State Saved	Saved in instrument state.
Range	On Off
Initial S/W Revision	Prior to A.02.00
Modified at S/W Revision	A.02.00, A.03.00

Marker All Off

Turns all active markers off.

Key Path	Marker
Mode	SA, WCDMA, C2K, WIMAX OFDMA, TD-SCDMA, 1xEVDO, DVB-T/H, DTMB (CTTB), ISDB-T, CMMB, LTE, LTETDD, Digital Cable TV, MSR, LTEAFDD,LTEATDD
Remote Command	:CALCulate:ACPower:MARKer:AOFF
Example	CALC:ACP:MARK:AOFF
Dependencies	This key is unavailable when "Meas Method" on page 651 is set to RBW.
Initial S/W Revision	Prior to A.02.00
Modified at S/W Revision	A.02.00, A.03.00

Marker X Axis Value (Remote Command only)

Sets the marker X axis value in the current marker X Axis Scale unit. This value has no effect if the control mode is Off, but is the SCPI equivalent of entering an X value if the control mode is Normal,Delta or Fixed.

Mode	SA, WCDMA, C2K, WIMAX OFDMA, TD-SCDMA, 1xEVDO, DVB-T/H, DTMB (CTTB), ISDB-T, CMMB, LTE, LTETDD, Digital Cable TV, MSR, LTEAFDD,LTEATDD
Remote Command	:CALCulate:ACPower:MARKer[1] 2 ... 12:X <freq> :CALCulate:ACPower:MARKer[1] 2 ... 12:X?

Example	CALC:ACP:MARK3:X 0 CALC:ACP:MARK3:X?
Notes	The query returns the marker's absolute X Axis value if the control mode is Normal, or the offset from the marker's reference marker if the control mode is Delta. If the marker is Off the response is not a number.
Dependencies	Unavailable when " Meas Method " on page 651 is set to RBW.
Preset	After a preset, all Markers are turned OFF, so Marker X Axis Value query will return a not a number (NAN).
State Saved	No
Min	-9.9E+37
Max	9.9E+37
Initial S/W Revision	Prior to A.02.00
Modified at S/W Revision	A.02.00, A.03.00

Marker X Axis Position (Remote Command only)

Sets the marker X position in trace points. It has no effect if the control mode is Off, but is the SCPI equivalent of entering a value if the control mode is Normal, Delta or Fixed. The entered value is immediately translated into the current X Axis Scale units for setting the value of the marker.

Mode	SA, WCDMA, C2K, WIMAX OFDMA, TD-SCDMA, 1xEVDO, DVB-T/H, DTMB (CTTB), ISDB-T, CMMB, LTE, LTE-TDD, Digital Cable TV, MSR, LTEAFDD, LTEATDD
Remote Command	:CALCulate:ACPower:MARKer[1] 2 ... 12:X:POSition <real> :CALCulate:ACPower:MARKer[1] 2 ... 12:X:POSition?
Example	CALC:ACP:MARK10:X:POS 0 CALC:ACP:MARK10:X:POS?
Notes	The query returns the marker's absolute X Axis value in trace points if the control mode is Normal, or the offset from the marker's reference marker in trace points if the control mode is Delta. The value is returned as a real number, not an integer, corresponding to the translation from X Axis Scale units to trace points (see "Fractional Trace Points"). If the marker is Off the response is not a number. When a Marker is turned on, it is placed center of the screen on the trace. Therefore the default value depends on instrument condition, although the Preset/Default is defined as 500 (this value might be expected value when all offset is on).
Dependencies	Unavailable when " Meas Method " on page 651 is set to RBW.
Preset	After a preset, all Markers are turned OFF, so Marker X Axis Value query will return a not a number (NAN).
State Saved	No
Min	-9.9E+37
Max	9.9E+37
Initial S/W Revision	Prior to A.02.00
Modified at S/W Revision	A.02.00, A.03.00

Marker Y Axis Value (Remote Command only)

Returns the marker Y axis value in the current marker Y axis unit.

Mode	SA, WCDMA, C2K, WIMAX OFDMA, TD-SCDMA, 1xEVDO, DVB-T/H, DTMB (CTTB), ISDB-T, CMMB, LTE, LTE-TDD, Digital Cable TV, MSR, LTEAFDD, LTEATDD
Remote Command	:CALCulate:ACPpower:MARKer[1] 2 ... 12:Y?
Example	CALC:ACP:MARK11:Y?
Notes	Since the result value is always calculated from acquisition data, the default value is arbitrary. Although the Preset/Default values are defined.
Dependencies	Unavailable when "Meas Method" on page 651 is set to RBW.
Preset	Result dependent on markers setup and signal source.
State Saved	No
Backwards Compatibility SCPI	:CALCulate:ACPpower:MARKer[1] 2 ... 12:FUNCTION:RESULT?
Initial S/W Revision	Prior to A.02.00
Modified at S/W Revision	A.02.00, A.03.00

Backward Compatibility Remote Commands

Sets or queries the state of a marker. Setting a marker which is off to the on state or 1 puts it in Normal mode and places it at the center of the screen.

Mode	SA, WCDMA, WIMAX OFDMA, CDMA2K, TDSCDMA, CDMA1XEV, DVB, DTMB, ISDBT, CMMB, LTE, LTE-TDD, DCATV, MSR, LTEAFDD, LTEATDD
Remote Command	:CALCulate:ACPpower:MARKer[1] 2 ... 12:STATe OFF ON 0 1 :CALCulate:ACPpower:MARKer[1] 2 ... 12:STATe?
Example	CALC:ACP:MARK2:STAT ON CALC:ACP:MARK2:STAT?
Notes	This parameter is also accessed from Marker, Properties, 1 You must be in the mode that includes ACP measurements to use this command. Use :INSTrument:SElect to set the mode.
Preset	OFF OFF OFF OFF OFF OFF OFF OFF OFF OFF OFF OFF
State Saved	Saved in instrument state.
Range	On Off
Initial S/W Revision	Prior to A.02.00
Modified at S/W Revision	A.02.00, A.03.00

Marker Function

There are no Marker Functions supported in the ACP measurement. The front-panel key will display a blank key menu when pressed.

Key Path	Front-panel key
Initial S/W Revision	Prior to A.02.00

Marker To

There is no Marker To functionality supported in ACP. The front-panel key will display a blank key menu when pressed.

Key Path	Front-panel key
Initial S/W Revision	Prior to A.02.00

Meas

The information in this section is common to all measurements. For key and remote command information for a specific measurement, refer to the section that describes the measurement of interest.

Measurements available under the Meas key are specific to the current Mode.

When viewing Help for measurements, note the following:

NOTE

Operation for some keys differs between measurements. The information displayed in Help pertains to the current measurement. To see how a key operates in a different measurement, exit Help (press the Cancel Esc key), select the measurement, then reenter Help (press the Help key) and press that key.

Key Path	Front-panel key
Initial S/W Revision	Prior to A.02.00

Remote Measurement Functions

This section contains the following topics:

"Measurement Group of Commands" on page 2016

"Current Measurement Query (Remote Command Only)" on page 2018

"Limit Test Current Results (Remote Command Only)" on page 2018

"Data Query (Remote Command Only)" on page 2018

"Calculate/Compress Trace Data Query (Remote Command Only)" on page 2019

"Calculate Peaks of Trace Data (Remote Command Only)" on page 2024

"Hardware-Accelerated Fast Power Measurement (Remote Command Only)" on page 2025

"Format Data: Numeric Data (Remote Command Only)" on page 2039

"Format Data: Byte Order (Remote Command Only)" on page 2040

Initial S/W Revision	Prior to A.02.00
----------------------	------------------

Measurement Group of Commands

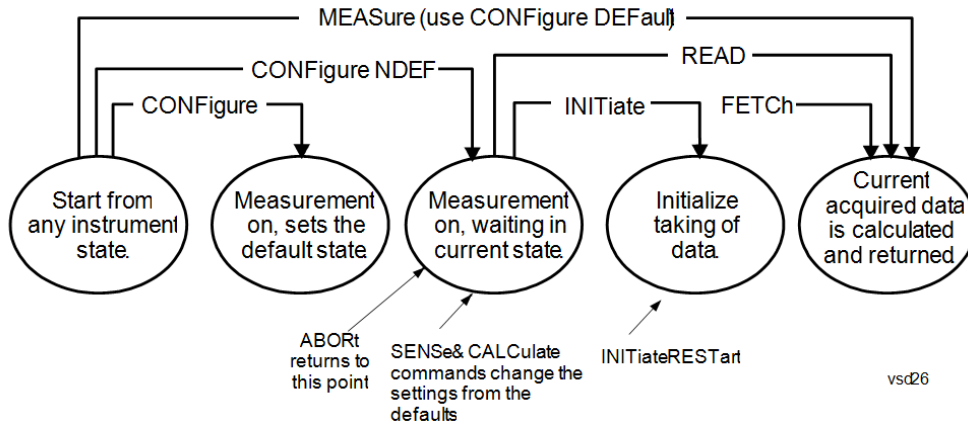

Measure Commands:

:MEASure:<measurement>[n]?

This is a fast single-command way to make a measurement using the factory default instrument settings. These are the settings and units that conform to the Mode Setup settings (e.g. radio standard) that you have currently selected.

- Stops the current measurement (if any) and sets up the instrument for the specified measurement using the factory defaults
- Initiates the data acquisition for the measurement
- Blocks other SCPI communication, waiting until the measurement is complete before returning results.
- If the function does averaging, it is turned on and the number of averages is set to 10.
- After the data is valid it returns the scalar results, or the trace data, for the specified measurement. The type of data returned may be defined by an [n] value that is sent with the command.
- The scalar measurement results will be returned if the optional [n] value is not included, or is set to 1. If the [n] value is set to a value other than 1, the selected trace data results will be returned. See each command for details of what types of scalar results or trace data results are available.
- ASCII is the default format for the data output. (Older versions of Spectrum Analysis and Phase Noise mode measurements only use ASCII.) The binary data formats should be used for handling large blocks of data since they are smaller and faster than the ASCII format. Refer to the FORMat:DATA command for more information.

If you need to change some of the measurement parameters from the factory default settings you can set up the measurement with the CONFIgure command. Use the commands in the SENSE:<measurement> and CALCulate:<measurement> subsystems to change the settings. Then you can use the READ? command to initiate the measurement and query the results.

If you need to repeatedly make a given measurement with settings other than the factory defaults, you can use the commands in the SENSE:<measurement> and CALCulate:<measurement> subsystems to set up the measurement. Then use the READ? command to initiate the measurement and query results.

Measurement settings persist if you initiate a different measurement and then return to a previous one. Use READ:<measurement>? if you want to use those persistent settings. If you want to go back to the default settings, use MEASure:<measurement>?.

Configure Commands:

:CONFIgure:<measurement>

This command stops the current measurement (if any) and sets up the instrument for the specified measurement using

the factory default instrument settings. It does not initiate the taking of measurement data unless INIT:CONTInuous is ON. If you change any measurement settings after using the CONFigure command, the READ command can be used to initiate a measurement without changing the settings back to their defaults.

In the Swept SA measurement in Spectrum Analyzer mode the CONFigure command also turns the averaging function on and sets the number of averages to 10 for all measurements.

:CONFigure: <measurement>: NDEFault stops the current measurement and changes to the specified measurement. It does not change the settings to the defaults. It does not initiate the taking of measurement data unless INIT:CONTInuous is ON.

The CONFigure? query returns the current measurement name.

The CONFigure:CATalog? query returns a quoted string of all licensed measurement names in the current mode. For example, "SAN, CHP, OBW, ACP, PST, TXP, SPUR, SEM, LIST".

Fetch Commands:

:FETCh:<measurement>[n]?

This command puts selected data from the most recent measurement into the output buffer. Use FETCh if you have already made a good measurement and you want to return several types of data (different [n] values, for example, both scalars and trace data) from a single measurement. FETCh saves you the time of re-making the measurement. You can only FETCh results from the measurement that is currently active, it will not change to a different measurement. An error message is reported if a measurement other than the current one is specified.

If you need to get new measurement data, use the READ command, which is equivalent to an INITiate followed by a FETCh.

The scalar measurement results will be returned if the optional [n] value is not included, or is set to 1. If the [n] value is set to a value other than 1, the selected trace data results will be returned. See each command for details of what types of scalar results or trace data results are available. The binary data formats should be used for handling large blocks of data since they are smaller and transfer faster than the ASCII format. (FORMat:DATA)

FETCh may be used to return results other than those specified with the original READ or MEASure command that you sent.

INITiate Commands:

:INITiate:<measurement>

This command is not available for measurements in all the instrument modes:

- Initiates a trigger cycle for the specified measurement, but does not output any data. You must then use the FETCh<meas> command to return data. If a measurement other than the current one is specified, the instrument will switch to that measurement and then initiate it.
- For example, suppose you have previously initiated the ACP measurement, but now you are running the channel power measurement. If you send INIT:ACP? it will change from channel power to ACP and will initiate an ACP measurement.
- Does not change any of the measurement settings. For example, if you have previously started the ACP measurement and you send INIT:ACP? it will initiate a new ACP measurement using the same instrument settings as the last time ACP was run.
- If your selected measurement is currently active (in the idle state) it triggers the measurement, assuming the trigger conditions are met. Then it completes one trigger cycle. Depending upon the measurement and the number of averages, there may be multiple data acquisitions, with multiple trigger events, for one full trigger cycle. It also holds off additional commands on GPIB until the acquisition is complete.

READ Commands:

:READ:<measurement>[n]?

- Does not preset the measurement to the factory default settings. For example, if you have previously initiated the ACP
-

measurement and you send READ:ACP? it will initiate a new measurement using the same instrument settings.

- Initiates the measurement and puts valid data into the output buffer. If a measurement other than the current one is specified, the instrument will switch to that measurement before it initiates the measurement and returns results.
 - For example, suppose you have previously initiated the ACP measurement, but now you are running the channel power measurement. Then you send READ:ACP? It will change from channel power back to ACP and, using the previous ACP settings, will initiate the measurement and return results.
 - Blocks other SCPI communication, waiting until the measurement is complete before returning the results
 - If the optional [n] value is not included, or is set to 1, the scalar measurement results will be returned. If the [n] value is set to a value other than 1, the selected trace data results will be returned. See each command for details of what types of scalar results or trace data results are available. The binary data formats should be used when handling large blocks of data since they are smaller and faster than the ASCII format. (FORMat:DATA)
-

Initial S/W Revision	Prior to A.02.00
----------------------	------------------

Current Measurement Query (Remote Command Only)

This command returns the name of the measurement that is currently running.

Remote Command	:CONFigure?
-----------------------	-------------

Example	CONF?
----------------	-------

Initial S/W Revision	Prior to A.02.00
----------------------	------------------

Limit Test Current Results (Remote Command Only)

Queries the status of the current measurement limit testing. It returns a 0 if the measured results pass when compared with the current limits. It returns a 1 if the measured results fail any limit tests.

Remote Command	:CALCulate:CLIMits:FAIL?
-----------------------	--------------------------

Example	CALC:CLIM:FAIL? queries the current measurement to see if it fails the defined limits. Returns a 0 or 1: 0 it passes, 1 it fails.
----------------	--

Initial S/W Revision	Prior to A.02.00
----------------------	------------------

Data Query (Remote Command Only)

Returns the designated measurement data for the currently selected measurement and subopcode.

n = any valid subopcode for the current measurement. See the measurement command results table for your current measurement, for information about what data is returned for the subopcodes.

This command uses the data setting specified by the FORMat:BORDER and FORMat:DATA commands and can return real or ASCII data. (See the format command descriptions under Input/Output in the Analyzer Setup section.)

Remote Command	:CALCulate:DATA[n]?
Notes	The return trace depends on the measurement. In CALCulate:<meas>:DATA[n], n is any valid subopcode for the current measurement. It returns the same data as the FETCH:<measurement>? query where <measurement> is the current measurement.
Initial S/W Revision	Prior to A.02.00

Calculate/Compress Trace Data Query (Remote Command Only)

Returns compressed data for the currently selected measurement and sub-opcode [n].

n = any valid sub-opcode for that measurement. See the MEASure:<measurement>? command description of your specific measurement for information on the data that can be returned.

The data is returned in the current Y Axis Unit of the analyzer. The command is used with a sub-opcode <n> (default=1) to specify the trace. With trace queries, it is best if the analyzer is not sweeping during the query. Therefore, it is generally advisable to be in Single Sweep, or Update=Off.

This command is used to compress or decimate a long trace to extract and return only the desired data. A typical example would be to acquire N frames of GSM data and return the mean power of the first burst in each frame. The command can also be used to identify the best curve fit for the data.

Remote Command	:CALCulate:DATA<n>:COMPRESS? BLOCK CFIT MAXimum MINimum MEAN DMEan RMS RMSCubed SAMPLE SDEVIation PPHase [,<soffset> [,<length>[,<roffset>[,<rlimit>]]]]
Example	To query the mean power of a set of GSM bursts: Supply a signal that is a set of GSM bursts. Select the IQ Waveform measurement (in IQ Analyzer Mode). Set the sweep time to acquire at least one burst. Set the triggers such that acquisition happens at a known position relative to a burst. Then query the mean burst levels using, CALC:DATA2:COMP? MEAN, 24e-6, 526e-6 (These parameter values correspond to GSM signals, where 526e-6 is the length of the burst in the slot and you just want 1 burst.)
Notes	The command supports 5 parameters. Note that the last 4 (<soffset>, <length>, <roffset>, <rlimit>) are optional. But these optional parameters must be entered in the specified order. For example, if you want to specify <length>, then you must also specify <soffset>. See details below for a definition of each of these parameters. This command uses the data in the format specified by FORMat:DATA, returning either binary or ASCII data.
Initial S/W Revision	Prior to A.02.00

- BLOCK or block data - returns all the data points from the region of the trace data that you specify. For example, it could be used to return the data points of an input signal over several timeslots, excluding the portions of the trace data that you do not want. (This is x,y pairs for trace data and I,Q pairs for complex data.)

- CFIT or curve fit - applies curve fitting routines to the data. <soffset> and <length> are required to define the data that you want. <roffset> is an optional parameter for the desired order of the curve equation. The query will return the following values: the x-offset (in seconds) and the curve coefficients ((order + 1) values).

MIN, MAX, MEAN, DME, RMS, RMSC, SAMP, SDEV and PPH return one data value for each specified region (or <length>) of trace data, for as many regions as possible until you run out of trace data (using <roffset> to specify regions). Or they return the number of regions you specify (using <rlimit>) ignoring any data beyond that.

- MINimum - returns the minimum data point (y value) for the specified region(s) of trace data. For I/Q trace data, the minimum magnitude of the I/Q pairs is returned.
- MAXimum - returns the maximum data point (y value) for the specified region(s) of trace data. For I/Q trace data, the maximum magnitude of the I/Q pairs is returned.
- MEAN - returns a single value that is the arithmetic mean of the data point values (in dB/ dBm) for the specified region(s) of trace data. For I/Q trace data, the mean of the magnitudes of the I/Q pairs is returned. See the following equations.

NOTE If the original trace data is in dB, this function returns the arithmetic mean of those log values, not log of the mean power which is a more useful value. The mean of the log is the better measurement technique when measuring CW signals in the presence of noise. The mean of the power, expressed in dB, is useful in power measurements such as Channel Power. To achieve the mean of the power, use the RMS option.

Equation 1

Mean Value of Data Points for Specified Region(s)

$$MEAN = \frac{1}{n} \sum_{X_i \in \text{region}(s)} X_i$$

where X_i is a data point value, and n is the number of data points in the specified region(s).

Equation 2

Mean Value of I/Q Data Pairs for Specified Region(s)

$$MEAN = \frac{1}{n} \sum_{X_i \in \text{region}(s)} |X_i|$$

where $|X_i|$ is the magnitude of an I/Q pair, and n is the number of I/Q pairs in the specified region(s).

- DMEan - returns a single value that is the mean power (in dB/ dBm) of the data point values for the specified region(s) of trace data. See the following equation:

Equation 3

DMEan Value of Data Points for Specified Region(s)

$$\text{DME} = 10 \times \log_{10} \left(\frac{1}{n} \sum_{X_i \in \text{region}(s)} 10^{\frac{X_i}{10}} \right)$$

- RMS - returns a single value that is the average power on a root-mean-squared voltage scale (arithmetic rms) of the data point values for the specified region(s) of trace data. See the following equation.

NOTE

For I/Q trace data, the rms of the magnitudes of the I/Q pairs is returned. See the following equation. This function is very useful for I/Q trace data. However, if the original trace data is in dB, this function returns the rms of the log values which is not usually needed.

Equation 4

RMS Value of Data Points for Specified Region(s)

$$\text{RMS} = \sqrt{\frac{1}{n} \sum_{X_i \in \text{region}(s)} X_i^2}$$

where X_i is a data point value, and n is the number of data points in the specified region(s).

Equation 5

RMS Value of I/Q Data Pairs for Specified Region(s)

$$\text{RMS} = \sqrt{\frac{1}{n} \sum_{X_i \in \text{region}(s)} X_i X_i^*}$$

where X_i is the complex value representation of an I/Q pair, X_i^* its conjugate complex number, and n is the number of I/Q pairs in the specified region(s).

Once you have the rms value for a region of trace data (linear or I/Q), you may want to calculate the mean power. You must convert this rms value (peak volts) to power in dBm:

$$10 \times \log[10 \times (\text{rms value})^2]$$

- SAMPlE - returns the first data value (x,y pair) for the specified region(s) of trace data. For I/Q trace data, the first I/Q pair is returned.
- SDEVIation - returns a single value that is the arithmetic standard deviation for the data point values for the specified region(s) of trace data. See the following equation.
- For I/Q trace data, the standard deviation of the magnitudes of the I/Q pairs is returned. See the following equation.

Equation 6

Standard Deviation of Data Point Values for Specified Region(s)

$$\text{SDEV} = \sqrt{\frac{1}{n} \sum_{X_i \in \text{region}(s)} (X_i - \bar{X})^2}$$

where X_i is a data point value, \bar{X} is the arithmetic mean of the data point values for the specified region (s), and n is the number of data points in the specified region(s).

$$\text{SDEV} = \sqrt{\frac{1}{n} \sum_{X_i \in \text{region}(s)} (|X_i| - \bar{X})^2}$$

where $|X_i|$ is the magnitude of an I/Q pair, \bar{X} is the mean of the magnitudes for the specified region(s), and n is the number of data points in the specified region(s).

- PPHase - returns the x,y pairs of both rms power (dBm) and arithmetic mean phase (radian) for every specified region and frequency offset (Hz). The number of pairs is defined by the specified number of regions. This parameter can be used for I/Q vector ($n=0$) in Waveform (time domain) measurement and all parameters are specified by data point in PPHase.

The rms power of the specified region may be expressed as:

$$\text{Power} = 10 \times \log [10 \times (\text{RMS I/Q value})] + 10.$$

The RMS I/Q value (peak volts) is:

$$\sqrt{\frac{1}{n} \sum_{X_i \in \text{region}} X_i X_i^*}$$

where X_i is the complex value representation of an I/Q pair, X_i^* its conjugate complex number, and n is the number of I/Q pairs in the specified region.

The arithmetic mean phase of the specified region may be expressed as:

$$\frac{1}{n} \sum_{Y_i \in \text{region}} Y_i$$

where Y_i is the unwrapped phase of I/Q pair with applying frequency correction and n is the number of I/Q pairs in the specified region.

The frequency correction is made by the frequency offset calculated by the arithmetic mean of every specified region's frequency offset. Each frequency offset is calculated by the least square method against the unwrapped phase of I/Q pair.

Sample Trace Data - Constant Envelope

(See below for explanation of variables.)

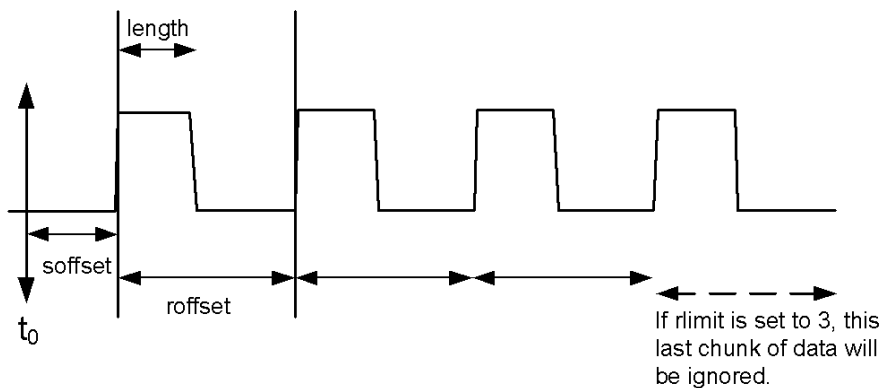

Sample Trace Data - Not Constant Envelope

(See below for explanation of variables.)

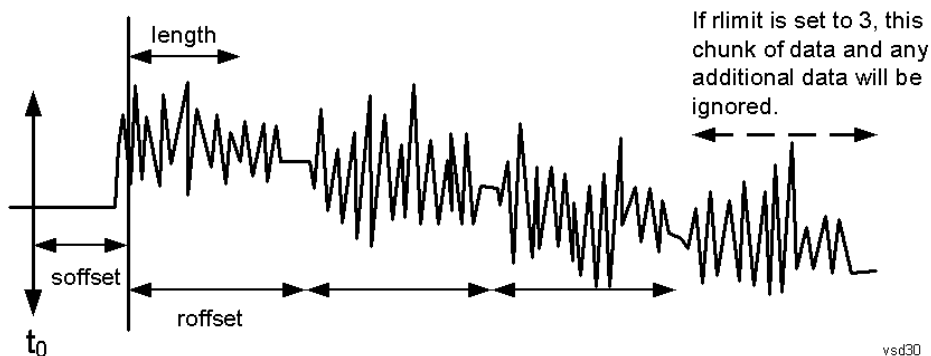

<soffset> - start offset is an optional real number. (It is in seconds for time-domain traces, and is a dimensionless index 0 to Npoints - 1, for frequency-domain traces). It specifies the amount of data at the beginning of the trace that will be ignored before the decimation process starts. It is the time or frequency change from the start of the trace to the point where you want to start using the data. The default value is zero.

<length> - is an optional real number. (It is in seconds for time-domain traces, and is a dimensionless index 0 to Npoints - 1, for frequency-domain traces). It defines how much data will be compressed into one value. This parameter has a default value equal to the current trace length.

<roffset> - repeat offset is an optional real number. (It is in seconds for time-domain traces, and is a dimensionless index 0 to Npoints - 1, for frequency-domain traces). It defines the beginning of the next field of trace elements to be compressed. This is relative to the beginning of the previous field. This parameter has a default value equal to the <length> variable. Note that this parameter is used for a completely different purpose when curve fitting (see CFIT above).

<rlimit> - repeat limit is an optional integer. It specifies the number of data items that you want returned. It will ignore any additional items beyond that number. You can use the Start offset and the Repeat limit to pick out exactly what part of the data you want to use. The default value is all the data.

Calculate Peaks of Trace Data (Remote Command Only)

Returns a list of all the peaks for the currently selected measurement and sub-opcode [n]. The peaks must meet the requirements of the peak threshold and excursion values.

n = any valid sub-opcode for the current measurement. See the MEASure:<measurement> command description of your specific measurement for information on the data that can be returned.

The command can only be used with specific sub-opcodes with measurement results that are trace data. Both real and complex traces can be searched, but complex traces are converted to magnitude in dBm. In many measurements the sub-opcode n=0, is the raw trace data which cannot be searched for peaks. And Sub-opcode n=1, is often calculated results values which also cannot be searched for peaks.

This command uses the data setting specified by the FORMat:BORDER and FORMat:DATA commands and can return real or ASCII data. If the format is set to INT,32, it returns REAL,32 data.

The command has four types of parameters:

- Threshold (in dBm)
- Excursion (in dB)
- Sorting order (amplitude, frequency, time)
- Optional in some measurements: Display line use (all, > display line, < display line)

Remote Command	<p>For Swept SA measurement:</p> <pre>:CALCulate:DATA[1] 2 ... 6:PEAKs? <threshold>,<excursion>[,AMPLitude FREQuency TIME[,ALL GTDLine LTDLine]]</pre> <p>For most other measurements:</p> <pre>:CALCulate:DATA[1] 2 ... 6:PEAKs? <threshold>,<excursion>[,AMPLitude FREQuency TIME]</pre>
-----------------------	--

Example	<p>Example for Swept SA measurement in Spectrum Analyzer Mode:</p> <p>CALC:DATA4:PEAK? -40, 10, FREQ, GTDL This will identify the peaks of trace 4 that are above -40 dBm, with excursions of at least 10 dB. The peaks are returned in order of increasing frequency, starting with the lowest frequency. Only the peaks that are above the display line are returned.</p> <p>Query Results 1:</p> <p>With FORMat:DATA REAL, 32 selected, it returns a list of floating-point numbers. The first value in the list is the number of peak points that are in the following list. A peak point consists of two values: a peak amplitude followed by its corresponding frequency (or time).</p> <p>If no peaks are found the peak list will consist of only the number of peaks, (0).</p>
----------------	---

Notes	<p><n> - is the trace that will be used</p> <p><threshold> - is the level below which trace data peaks are ignored. Note that the threshold value is required and is always used as a peak criterion. To effectively disable the threshold criterion for this command, provide a substantially low threshold value such as -200 dBm. Also note that the threshold value used in this command is independent of and has no effect on the threshold value stored under the Peak Criteria menu.</p> <p><excursion> - is the minimum amplitude variation (rise and fall) required for a signal to be identified as peak. Note that the excursion value is required and is always used as a peak criterion. To effectively disable the excursion criterion for this command, provide the minimum value of 0.0 dB. Also note that the excursion value used in this command is independent of and has no effect on the</p>
--------------	---

excursion value stored under the Peak Criteria menu.

Values must be provided for threshold and excursion. The sorting and display line parameters are optional (defaults are AMPLitude and ALL).

Note that there is always a Y-axis value for the display line, regardless of whether the display line state is on or off. It is the current Y-axis value of the display line which is used by this command to determine whether a peak should be reported. Sorting order:

AMPLitude - lists the peaks in order of descending amplitude, with the highest peak first (default if optional parameter not sent)

FREQUENCY - lists the peaks in order of occurrence, left to right across the x-axis.

TIME - lists the peaks in order of occurrence, left to right across the x-axis.

Peaks vs. Display Line:

ALL - lists all of the peaks found (default if optional parameter not sent).

GTDLine (greater than display line) - lists all of the peaks found above the display line.

LTDLine (less than display line) - lists all of the peaks found below the display line.

Initial S/W Revision	Prior to A.02.00
----------------------	------------------

Hardware-Accelerated Fast Power Measurement (Remote Command Only)

The Fast Power option (FP2) enables very fast channel power measurements for instruments with the prerequisite hardware (DP2 and/or B40). It accomplishes this by performing real-time overlapped FFTs at the hardware layer, using software for basic post-processing before returning the result to the user. The upshot of this approach is improved throughput for user applications that require many sequential power measurements.

The analysis bandwidth of FP2 is limited by the licenses in the instrument, but its maximum overall analysis bandwidth per acquisition is 40 MHz.

FP2 is remote-only, which means the instrument does not switch to any particular mode or measurement. FP2 commands can be sent while another application is in use on the front panel.

Each Fast Power measurement can be predefined using an array index, and up to 1,000 measurements can be stored. In the following documentation, instances of [1,2,...,999] can be substituted with a particular measurement index, e.g. CALC:FPOW:POW1?, CALC:FPOW:POW2?, CALC:FPOW:POW134?. In this way, power measurements can be defined one time in a batch, and then executed multiple times without having to redefine them, similar to “list mode” on other measurements.

In addition to basic channel power measurements, there are a number of other measurement “functions” for each channel, including peak power, peak frequency, and power spectral density. See the Function parameter for more information.

Reset Fast Power Measurement (Remote Command Only)

Resets the measurement configuration to the defaults.

Mode	All
Remote Command	:CALCulate:FPOWer:POWer[1,2,...,999]:RESet
Example	:CALC:FPOW:POW1:RES

Notes	Option FP2 is required.
Initial S/W Revision	A.14.00

Define Fast Power Measurement (Remote Command Only)

Fast Power acquisitions are configured using the DEFine command. This command accepts a comma-delimited string of configuration parameters and their appropriate values, which are all specified in the subsection below.

Mode	All
Remote Command	:CALCulate:FPOWER:POWer[1,2,...,999]:DEFine "configuration string"
Example	:CALC:FPOW:POW1:DEF "CenterFrequency=2e9, AcquisitionTime=0.005"
Notes	See below for a list of measurement variables that can be defined in the configuration string.
Initial S/W Revision	A.14.00

Acquisition Time

Example	CALC:FPOW:POW1:DEF "AcquisitionTime=0.002"
Notes	The acquisition time parameter sets the time in which the entire spectrum is measured. An increase in the acquisition time yields an improvement in measurement repeatability.
Preset	0.001 s
Range	0 s to 1 s
Default Unit	Time (s)
Initial S/W Revision	A.14.00

Center Frequency

Example	CALC:FPOW:POW1:DEF "CenterFrequency=2e9"
Notes	The center frequency parameter sets the frequency in which the measurement is centered around. The OffsetFrequency parameter is calculated relative to the center frequency.
Preset	1 GHz
Range	0 Hz to maximum instrument frequency
Default Unit	Frequency (Hz)
Initial S/W Revision	A.14.00

DC Coupled

Example	CALC:FPOW:POW1:DEF "DCCoupled=True"
Notes	The DC coupled parameter allows the user to specify whether the DC blocking capacitor is utilized. Set parameter to true when measuring frequencies below 10 MHz.
Preset	False
Range	True (DC Coupled) or False (AC Coupled)
Default Unit	Boolean
Initial S/W Revision	A.14.00

DetectorType

Example	CALC:FPOW:POW1:DEF "DetectorType=Peak"
Notes	Option FP2 is required. The detector type parameter allows the user to choose whether a RMS average or peak value is used during the measurement.
Preset	RmsAverage
Range	RmsAverage, Peak
Initial S/W Revision	A.14.00

Do Noise Correction

Example	CALC:FPOW:POW1:DEF "DoNoiseCorrection=True"
Notes	When noise correction is enabled, the linear noise power contributed by the analyzer is subtracted from all measurements. This effectively lowers the noise floor of the analyzer. When noise correction is enabled, the first measurement for a given set of input parameters will take extra time. This is because the analyzer takes an extra acquisition with the RF input disconnected from the analyzer's front end to measure the noise of just the analyzer. The measured noise floor is stored in a cache so the noise acquisition will occur only once for the same state settings. In other words, if noise correction was turned on and the analyzer made an acquisition at frequency A, then frequency B, and back again to frequency A, the hidden initial noise floor acquisition would only occur for the first acquisition at frequency A and the cached noise floor would be used the second time frequency A was measured.
Preset	False
Range	True (enable noise correction) or False (disable noise correction)
Default Unit	Boolean
Initial S/W Revision	A.14.00

Do Spur Suppression

Example	CALC:FPOW:POW1:DEF "DoSpurSuppression=True"
Notes	<p>When measuring very low level signals, or when large out-of-band inputs are input into the analyzer, sometimes unwanted spurs and residuals can appear in the measured spectrum. Spur suppression is a method to help minimize the levels of these internally generated spurs and residuals.</p> <p>When spur suppression is enabled, the analyzer will automatically take two acquisitions using two different internal analog LO frequencies. The FFT spectrums from both acquisitions are combined by taking the minimum power between both traces on a per FFT bin basis. External signals will have the same amplitude for both traces and therefore will return the expected amplitudes. However, low level spurs and residuals generated internally to the analyzer tend to move to different FFT bins depending on the internal analog LO frequency used, and therefore tend to be suppressed using this spur suppression method.</p> <p>Because two acquisitions, rather than a single acquisition, are made when spur suppression is enabled, the measurement time will always be slower when spur suppression is enabled.</p>
Preset	False
Range	True (enable spur suppression) or False (disable spur suppression)
Default Unit	Boolean
Initial S/W Revision	A.14.00

Electronic Attenuator Bypass

Example	CALC:FPOW:POW1:DEF "ElecAttBypass =False"
Notes	The electronic attenuation bypass parameter allows the user to either utilize or bypass the electronic attenuator. The electronic attenuator is only available for frequencies up to 3.6 GHz. Set parameter to true when using frequencies above 3.6 GHz and set the parameter to false when using the preamp.
Preset	True
Range	True (bypass electronic attenuator) or False (use electronic attenuator)
Default Unit	Boolean
Initial S/W Revision	A.14.00

Electronic Attenuation

Example	CALC:FPOW:POW1:DEF "ElecAttenuation=10"
Notes	<p>Option EA3 is required.</p> <p>The electronic attenuation value parameter sets the amount of electrical attenuation from 0 to 24 dB (1 dB steps).</p> <p>Set "ElecAttBypass=False" to make sure the electronic attenuator path is enabled.</p>
Preset	0 dB
Range	0 – 24 dB (1 dB steps)

Default Unit	dB
Initial S/W Revision	A.14.00

IF Gain

Example	CALC:FPOW:POW1:DEF "IFGain=10"
Notes	The IF gain parameter allows the user to specify the gain at the IF stage anywhere from -6 to 16 dB (1 dB steps). This is an advanced feature, and for most cases this should remain at its default value of 0 dB.
Preset	0 dB
Range	-6 - 16 dB (1 dB steps)
Default Unit	dB
Initial S/W Revision	A.14.00

IF Type

Example	CALC:FPOW:POW1:DEF "IFType=B25M"
Notes	The IF type parameter allows the user to select between different IF paths. For example, if the signal is less than 25 MHz wide, then the user can select the B25M path to take advantage of additional filtering on this analog IF path.
Preset	B40M
Range	B10M, B25M, B40M
Initial S/W Revision	A.14.00

Include Power Spectrum

Example	CALC:FPOW:POW1:DEF "IncludePowerSpectrum=True"
Notes	The power spectrum parameter allows the user to read data on the entire spectrum for diagnostic purposes. It is not recommended for production use. See CALC:FPOW:POW[n]:READ2? for details on the binary format of the response.
Preset	False
Range	True (return both channel power and full power spectrum) or False (returns only channel power)
Default Unit	Boolean
Initial S/W Revision	A.14.00

Mechanical Attenuation

Example	CALC:FPOW:POW1:DEF "MechAttenuation=10"
Notes	The mechanical attenuation value parameter sets the amount of mechanical attenuation anywhere from 0 to 70 dB (2 dB steps).
Preset	0 dB
Range	0 – 70 dB (2 dB steps)
Default Unit	dB
Initial S/W Revision	A.14.00

Preamp Mode

Example	CALC:FPOW:POW1:DEF "PreAmpMode=Low"
Notes	The license for the appropriate preamp is required. The preamp mode parameter specifies whether the preamps are being utilized. Low allows any preamps up to 3.6 GHz, and Full allows all licensed preamps. Set "ElecAttBypass=True" in order to utilize any preamps.
Preset	Off
Range	Off, Low, Full
Initial S/W Revision	A.14.00

Resolution Bandwidth Mode

Example	CALC:FPOW:POW1:DEF "PreAmpMode=Low"
Notes	The resolution bandwidth mode parameter allows the user to choose whether the RBW filter is automatically or manually set. The BestSpeed value minimizes measurement time, while the Narrowest value minimizes RBW size (minimum of two FFT bins per RBW). To manually specify an RBW, set this parameter to Explicit, and set the ResolutionBW parameter to the desired value.
Preset	BestSpeed
Range	BestSpeed, Narrowest, Explicit
Initial S/W Revision	A.14.00

Resolution Bandwidth

Example	CALC:FPOW:POW1:DEF "ResolutionBW=25e3"
Notes	The resolution bandwidth parameter sets the 3-dB bandwidth of the RBW filter. The ResolutionBWMode parameter must be set to Explicit in order to manually set the RBW.

Preset	0 Hz
Default Unit	Hz
Initial S/W Revision	A.14.00

Trigger Delay

Example	CALC:FPOW:POW1:DEF "TriggerDelay=0.025"
Notes	The trigger delay parameter sets the time after an external trigger is detected until the measurement is performed.
Preset	0 s
Range	0 – 1 s
Default Unit	Seconds
Initial S/W Revision	A.14.00

Trigger Level

Example	CALC:FPOW:POW1:DEF "TriggerLevel=2"
Notes	The trigger level parameter sets the voltage value at which an external trigger is detected.
Preset	1.2 V
Range	-5 to 5 V
Default Unit	Volts
Initial S/W Revision	A.14.00

Trigger Slope

Example	CALC:FPOW:POW1:DEF "TriggerSlope=Negative"
Notes	The trigger slope parameter indicates the direction of the edge trigger voltage for detection.
Preset	Positive
Range	Positive, Negative
Initial S/W Revision	A.14.00

Trigger Source

Example	CALC:FPOW:POW1:DEF "TriggerSource=Ext1"
Notes	The trigger source parameter allows the user to choose between measurement's triggering freely or controlled by an external input. Ext1 and Ext2 correspond to Trigger 1 In and Trigger 2 In, respectively.
Preset	Free
Range	Free, Ext1, Ext2
Initial S/W Revision	A.14.00

Trigger Timeout

Example	CALC:FPOW:POW1:DEF "TriggerTimeout=0.1"
Notes	The trigger timeout parameter sets the time in which the analyzer will wait for a trigger before automatically performing the measurement.
Preset	1 s
Range	0 - 1 s
Default Unit	Seconds
Initial S/W Revision	A.14.00

Signal Input

Example	CALC:FPOW:POW1:DEF "SignalInput=Fp50MHzCW"
Notes	The signal input parameter allows the user to select between using the main RF input or the internal analyzer reference CW signal of 50 MHz.
Preset	FpMainRf
Range	FpMainRf, Fp50MHzCW
Initial S/W Revision	A.14.00

Use Preselector

Example	CALC:FPOW:POW1:DEF "UsePreSelector=True"
Notes	The preselector parameter allows the user to either utilize or bypass the front end tunable filter at frequencies above 3.6 GHz. For frequencies below 3.6 GHz, the preselector is automatically bypassed, so you do not need to set this parameter to False in those cases.
Preset	False
Range	True (use preselector above 3.6 GHz), or False (preselector bypassed)

Default Unit	Boolean
Initial S/W Revision	A.14.00

Channel Bandwidth Array

Example	CALC:FPOW:POW1:DEF "Bandwidth=[3.84e6, 5e6, 3.84e6]"
Notes	The bandwidth parameter array defines the bandwidth of each channel that will be measured. All array parameters should have the same number of elements. Alternatively, if all the elements are the same value, a single number with no square brackets can be used to define the parameter.
Preset	[1 e6]
Range	0 to 40 MHz
Default Unit	Hz
Initial S/W Revision	A.14.00

Channel Filter Type Array

Example	CALC:FPOW:POW1:DEF "FilterType=[RRC, IBW, RRC]"
Notes	The filter type parameter allows the user to choose between an integration bandwidth (IBW) filter or a root-raised-cosine (RRC) filter. The integration bandwidth filter weighs all frequencies within the bandwidth equally. The root-raised-cosine filter has an associated shape parameter, defined by the FilterAlpha parameter. All array parameters should have the same number of elements. Alternatively, if all the elements are the same value, a single value with no square brackets can be used to define the parameter.
Preset	[IBW]
Range	IBW, RRC
Initial S/W Revision	A.14.00

Channel Filter Alpha Array

Example	CALC:FPOW:POW1:DEF "FilterAlpha=[0.5, 0.0, 0.5]"
Notes	The filter alpha parameter allows the user to adjust the alpha value associated with the root-raised-cosine (RRC) filter type. Set FilterType to RRC in order to utilize this parameter. All array parameters should have the same number of elements. Alternatively, if all the elements are the same value, a single number with no square brackets can be used to define the parameter.
Preset	[0.22]
Range	0.0 - 1.0

Initial S/W Revision	A.14.00
-------------------------	---------

Channel Measurement Function Array

Example	CALC:FPOW:POW1:DEF "Function=[BandPower, PeakPower, BandPower]"
Notes	<p>This parameter array defines what measurement is being made for each individually-specified channel:</p> <p>BandPower: Total power within the specified bandwidth of the channel (dBm)</p> <p>BandDensity: Total power density within the specified bandwidth of the channel (dBm/Hz)</p> <p>PeakPower: The peak power value within the specified bandwidth of the channel (dBm)</p> <p>PeakFrequency: The frequency which corresponds to the peak power value within the specified bandwidth of the channel. This frequency is relative to the center frequency (Hz)</p> <p>XdBBandwidth: The half power (-3.01 dB) bandwidth of the highest amplitude signal that resides within the channel (Hz), dB is configurable using XdBBandwidth parameter</p> <p>OccupiedBandwidth: The bandwidth at which 99% of the total power resides within the channel (Hz), percentage configurable using OccupiedBandwidthPercent parameter</p> <p>All array parameters should have the same number of elements. Alternatively, if all the elements are the same value, a single value with no square brackets can be used to define the parameter.</p>
Preset	[BandPower]
Range	BandPower, BandDensity, PeakPower, PeakFrequency, XdBBandwidth, OccupiedBandwidth
Initial S/W Revision	A.14.00

Channel Offset Frequency Array

Example	CALC:FPOW:POW1:DEF "OffsetFrequency=[-5e6, 0, 5e6]"
Notes	<p>The offset frequency parameter array defines the difference between the center frequency to the center frequency of each channel.</p> <p>All array parameters should have the same number of elements.</p>
Preset	[0]
Range	0 to 20 MHz
Default Unit	Hz
Initial S/W Revision	A.14.00

Channel Occupied Bandwidth Percent Array

Example	CALC:FPOW:POW1:DEF "OccupiedBandwidthPercent =[0.95, 0.95, 0.95]"
Notes	This parameter only applies for channels whose Function is set to OccupiedBandwidth. The occupied

bandwidth percent parameter specifies the percent of total power in these channels. The valid range for this parameter is 0.0 to 1.0, where 1.0 represents 100%. The default for this parameter is 0.99, which will return the bandwidth that contains 99% of the total channel power.

Preset	[0.99]
Range	0 – 1.0
Initial S/W Revision	A.14.00

Channel x-dB Bandwidth Array

Example	CALC:FPOW:POW1:DEF " XdBBandwidth =[-6.02, -3.01, -1.0]"
Notes	This parameter only applies for channels whose Function is set to XdBBandwidth. The X dB bandwidth parameter is used to specify the power relative to the peak channel power over which the bandwidth is calculated. The parameter value must be a negative number.
Preset	[-3.01]
Range	-200 to 0 dB
Default Unit	dB
Initial S/W Revision	A.14.00

Define Fast Power Measurement Query (Remote Command Only)

The DEFine? command is used to retrieve a list of all defined parameters in an ASCII string format

```

M All
o
d
e
R :CALCulate:FPOWER:POWer [1,2,...,999]:DEFine?
e
m
o
t
e
C
o
m
m
a
n
d
E :CALC:FPOW:POW1:DEF?

```

x
a
m
p
l
e

N This command query is used to retrieve a list of all defined parameters in an ASCII format.
o The following is an example of the returned results:
t "DCCoupled=False,ElecAttBypass=True,ElecAttenuation=0,IFGain=0,MechAttenuation=0,PreAmpMode=Off,PreSelectorOffset
e =0,UsePreSelector=False,ExternalReferenceFrequency=10000000,FrequencyReferenceSource=AutoExternalFrequencyRefer
s ence,IFType=B40M,LOMode=SLW,SignalInput=FpMainRf,AcquisitionTime=0.001,CenterFrequency=1000000000,Resolution
BW=0,ResolutionBWMode=BestSpeed,DetectorType=RmsAverage,Bandwidth=[1000000],OffsetFrequency=[0],Function=
[BandPower],FilterType=[IBW],FilterAlpha=[0.22],OccupiedBandwidthPercent=[0.99],XdBBandwidth=[-
3.01],DoNoiseCorrection=False,DoSpurSuppression=False,MeasurementMethod=HardwareFFT,IncludePowerSpectrum=False,
e,TriggerDelay=0,TriggerLevel=1.2,TriggerSlope=Positive,TriggerSource=Free,TriggerTimeout=1 "

I A.14.00
n
i
t
i
a
l

S
/
W

R
e
v
i
s
i
o
n

Configure Fast Power Measurement (Remote Command Only)

The configure command begins hardware setup and returns immediately, with no acquisition made. This can be used in parallel with other hardware operations to effectively hide the hardware setup time.

Mode	All
Remote Command	:CALCulate:FPOWer:POWer[1,2,...,999]:CONFigure
Example	:CALC:FPOW:POW1:CONF
Notes	Option FP2 is required.
Initial S/W Revision	A.14.00

Initiate Fast Power Measurement (Remote Command Only)

The INITiate command begins an acquisition and returns immediately. The results of the measurement can be retrieved using FETCh.

Mode	All
Remote Command	:CALCulate:FPOWer:POWer[1,2,...,999]:INITiate
Example	:CALC:FPOW:POW1:INIT
Notes	Option FP2 is required.
Initial S/W Revision	A.14.00

Fetch Fast Power Measurement (Remote Command Only)

The FETCh command query is used to retrieve the results of an acquisition initiated by the INIT command. The returned results are in ASCII string format. The string begins and ends with quotation marks.

Mode	All
Remote Command	:CALCulate:FPOWer:POWer[1,2,...,999]:FETCh?
Example	:CALC:FPOW:POW1:FETC?
Notes	Option FP2 is required. Returns m comma-separated ASCII values, where m corresponds to the number of bandwidths defined. 1. Declared function return in the 1st specified channel 2. Declared function return in the 2nd specified channel ... m. Declared function return in the last specified channel The INIT and FETC? command sequence performs the same functionality of a single CALC:FPOW:POW[n]? query. Units of the returned values are dependent on the Function parameter for each channel.
Initial S/W Revision	A.14.00

Execute Fast Power Measurement (Remote Command Only)

This command query is used as shorthand for an INIT command immediately followed by a FETC? command. The returned results are in ASCII string format. The string begins and ends with quotation marks.

Mode	All
Remote Command	:CALCulate:FPOWer:POWer[1,2,...,999]?
Example	:CALC:FPOW:POW1?

Notes	Option FP2 is required. See notes for Fast Power Fetch for return format.
Initial S/W Revision	A.14.00

Binary Read Fast Power Measurement (Remote Command Only)

This command query is used as shorthand for an INIT command immediately followed by a FETC? command. The returned results are in a binary format.

Mode	All
Remote Command	:CALCulate:FPOWER:POWER[1,2,...,999]:READ? :CALCulate:FPOWER:POWER[1,2,...,999]:READ1?
Example	:CALC:FPOW:POW1:READ? :CALC:FPOW:POW1:READ1?
Notes	Option FP2 is required. Returns m 4 byte floating point binary values (Little-Endian), where m corresponds to the number of bandwidths defined.
Initial S/W Revision	A.14.00

Diagnostic Binary Read Fast Power Measurement (Remote Command Only)

This command query is used as shorthand for an INIT command immediately followed by a FETC? command. The returned results are in a binary format. This command is used primarily for diagnostic purposes to test for ADC overloads and to visibly inspect the spectrum.

Mode	All
Remote Command	:CALCulate:FPOWER:POWER[1,2,...,999]:READ2?
Example	:CALC:FPOW:POW1:READ2?
Notes	Option FP2 is required. Note: Spectrum data is only returned if the IncludePowerSpectrum parameter is set to True. If IncludePowerSpectrum is False, the number of spectrum points will be zero (0). Units of the returned values are dependent on the Function parameter per channel (e.g. dBm for BandPower, Hz for PeakFrequency). Returns binary data (Little-Endian) that contains information on m amount of channels, along with ADC over range and full spectrum data. The following is the binary format of the response. Bandwidth Return Value 1. Number of channels specified, m [4 byte int] 2. Declared function result for the 1st specified channel [4 byte float]

-
- 3. Declared function result for the 2nd specified channel [4 byte float]
 - ...
 - (m + 1). Declared function result for the last (mth) specified channel [4 byte float]
- ADC Over Range
- 1. ADC over-range occurred (1: true, 0: false) [2 byte short]
- Spectrum Data
- 1. Number of points in the spectrum data, k [4 byte int]
 - 2. Start frequency of spectrum data (Hz) [8 byte double]
 - 3. Step frequency of spectrum data (Hz) [8 byte double]
 - 4. FFT bin at 1st point (dBm) [4 byte float]
 - 5. FFT bin at 2nd point (dBm) [4 byte float]
 - ...
 - (k + 3). FFT bin at last (kth) point (dBm) [4 byte float]
-

Initial S/W Revision A.14.00

Format Data: Numeric Data (Remote Command Only)

This command specifies the format of the trace data input and output. It specifies the formats used for trace data during data transfer across any remote port. It affects only the data format for setting and querying trace data for the :TRACe[:DATA], TRACe[:DATA]?, :CALCulate:DATA[n]? and FETCh:SANalyzer [n]? commands and queries.

Remote Command	:FORMat[:TRACe][:DATA] ASCii INTEger,32 REAL,32 REAL,64 :FORMat[:TRACe][:DATA]?
Notes	The query response is: ASCii: ASC,8 REAL,32: REAL,32 REAL,64: REAL,64 INTEger,32: INT,32 When the numeric data format is REAL or ASCii, data is output in the current Y Axis unit. When the data format is INTEger, data is output in units of m dBm (.001 dBm). The INT,32 format returns binary 32-bit integer values in internal units (m dBm), in a definite length block.
Dependencies	Sending a data format spec with an invalid number (for example, INT,48) generates no error. The analyzer simply uses the default (8 for ASCii, 32 for INTEger, 32 for REAL). Sending data to the analyzer which does not conform to the current FORMat specified, results in an error. Sending ASCII data when a definite block is expected generates message -161 "Invalid Block Data" and sending a definite block when ASCII data is expected generates message -121 "Invalid Character in Number".
Preset	ASCii
Backwards Compatibility	Note that the INT,32 format is only applicable to the command, TRACe:DATA. This preserves

Notes	backwards compatibility for the Swept SA measurement. For all other commands/queries which honor FORMat:DATA, if INT,32 is sent the analyzer will behave as though it were set to REAL,32.
Initial S/W Revision	Prior to A.02.00

The specs for each output type follow:

ASCIi - Amplitude values are in ASCII, in the current Y Axis Unit, one ASCII character per digit, values separated by commas, each value in the form:

SX.YYYYYEsZZ

Where:

S = sign (+ or -)

X = one digit to left of decimal point

Y = 5 digits to right of decimal point

E = E, exponent header

s = sign of exponent (+ or -)

ZZ = two digit exponent

REAL,32 - Binary 32-bit real values in the current Y Axis Unit, in a definite length block.

REAL,64 - Binary 64-bit real values in the current Y Axis Unit, in a definite length block.

Format Data: Byte Order (Remote Command Only)

This command selects the binary data byte order for data transfer and other queries. It controls whether binary data is transferred in normal or swapped mode. This command affects only the byte order for setting and querying trace data for the :TRACe[:DATA], TRACe[:DATA]? , :CALCulate:DATA[n]? and FETCh:SANalyzer[n]? commands and queries.

By definition any command that says it uses FORMat:DATA uses any format supported by FORMat:DATA.

The NORMal order is a byte sequence that begins with the most significant byte (MSB) first, and ends with the least significant byte (LSB) last in the sequence: 1|2|3|4. SWAPped order is when the byte sequence begins with the LSB first, and ends with the MSB last in the sequence: 4|3|2|1.

Remote Command	:FORMat:BORDer NORMal SWAPped :FORMat:BORDer?
Preset	NORMal
Initial S/W Revision	Prior to A.02.00

Meas Setup

Displays the setup menu for the currently selected measurement. The functions included in the measurement setup menu include setting the parameters for the carriers, offsets, bandwidths, measurement methods and types. This menu also allows you to turn noise correction on and off.

Key Path	Front-panel key
Initial S/W Revision	Prior to A.02.00

Average/Hold Number

Specifies the number of measurement averages used to calculate the measurement result. The average will be displayed at the end of each sweep. After the specified number of average counts, the average mode (termination control) setting determines the average action.

Key Path	Meas Setup
Mode	SA, WCDMA, C2K, WIMAX OFDMA, TD-SCDMA, 1xEVDO, DVB-T/H, DTMB (CTTB), ISDB-T, CMMB, LTE, LTE-TDD, Digital Cable TV, MSR, LTEAFDD, LTEATDD
Remote Command	[:SENSe]:ACPower:AVERage:COUNT <integer> [:SENSe]:ACPower:AVERage:COUNT? [:SENSe]:ACPower:AVERage[:STATe] OFF ON 0 1 [:SENSe]:ACPower:AVERage[:STATe]?
Example	ACP:AVER:COUN 250 ACP:AVER:COUN? ACP:AVER OFF ACP:AVER?
Notes	You must be in the mode that includes ACP measurements to use this command. Use :INSTRument:SElect to set the mode.
Preset	10 ON
State Saved	Saved in instrument state.
Min	1
Max	1000
Backwards Compatibility SCPI	[:SENSe]:ACPR:AVERage:COUNT [:SENSe]:MCPower:AVERage:COUNT (PSA Power Suite, PSA W-CDMA, PSA cdma2000)
Initial S/W Revision	Prior to A.02.00
Modified at S/W Revision	A.02.00, A.03.00

Avg Mode

Enables you to set the averaging mode. This determines the averaging action after the specified number of data acquisitions (average count) is reached.

When set to Exponential (Exp) the measurement averaging continues using the specified number of averages to compute each averaged value. The average will be displayed at the end of each sweep.

When set to Repeat, the measurement resets the average counter each time the specified number of averages is reached.

Key Path	Meas Setup
Mode	SA, WCDMA, C2K, WIMAX OFDMA, TD-SCDMA, 1xEVDO, DVB-T/H, DTMB (CTTB), ISDB-T, CMMB, LTE, LTETDD, Digital Cable TV, MSR, LTEAFDD, LTEATDD
Remote Command	[:SENSe] :ACPpower:AVERage:TCONtrol EXPonential REPEAT [:SENSe] :ACPpower:AVERage:TCONtrol ?
Example	ACP:AVER:TCON EXP ACP:AVER:TCON ?
Notes	You must be in the mode that includes ACP measurements to use this command. Use :INSTRument:SElect to set the mode.
Preset	EXPonential
State Saved	Saved in instrument state.
Range	Exp Repeat
Backwards Compatibility SCPI	[:SENSe] :ACPR:AVERage:TCONtrol
Initial S/W Revision	Prior to A.02.00
Modified at S/W Revision	A.02.00, A.03.00

Carrier Setup (This menu is unavailable in MSR)

Accesses a menu that contains Carriers, Ref Carrier, Ref Car Freq, Ref Car Pwr and Configure Carriers.

Key Path	Meas Setup
Initial S/W Revision	Prior to A.02.00

Carriers

Specifies the number of carriers to be measured.

Key Path	Meas Setup, Carrier Setup, Configure Carriers
Mode	SA, WCDMA, C2K, WIMAX OFDMA, 1xEVDO, TD-SCDMA, DVB-T/H, DTMB (CTTB), ISDB-T, CMMB, LTE, LTETDD, Digital Cable TV, LTEAFDD, LTEATDD

Remote Command	<code>[:SENSe] :ACPoweR:CARRier[1] 2:COUNT <integer></code> <code>[:SENSe] :ACPoweR:CARRier[1] 2:COUNT?</code>
Example	ACP:CARR:COUN 1 ACP:CARR:COUN?
Notes	Carrier sub op code. 1 for BTS, 2 for MS. Default is BTS. Note that Carrier sub op code 2 is supported only in Non-SA modes. In the SA mode, Carrier sub op code 1 is used for both BTS and MS. You must be in the mode that includes ACP measurements to use this command. Use :INSTrument:SElect to set the mode. For LTE-Advanced FDD/TDD mode, this key is blank. In order to keep backwards compatible with the legacy LTE FDD/TDD, the scpi command is supported in LTE & LTE-A converged application.
Dependencies	When Number of Carriers is 1, Ref Carrier is grayed out. If N9060A-5FP license is enabled, Max of Carrier is 18, otherwise, Max of Carrier is 12.
Couplings	Changing this parameter might affect the Span.
Preset	1
State Saved	Saved in instrument state.
Min	1
Max	Refer to Dependencies item.
Initial S/W Revision	Prior to A.02.00
Modified at S/W Revision	A.02.00, A.03.00

Ref Carrier

Sets the reference carrier. Relative power measurements are made from the reference carrier.

If set to Auto, the measurement selects the carrier with the highest power as the reference carrier and the Ref Carrier parameter is updated. If a value is entered when Ref Carrier Mode is set to Auto, the mode changes to Man.

If set to Man, the value that you enter for the Ref Carrier is used as the reference carrier.

Key Path	Meas Setup, Carrier Setup
Mode	SA, WCDMA, C2K, WIMAX OFDMA, 1xEVDO, TD-SCDMA, DVB-T/H, DTMB (CTTB), ISDB-T, CMMB, LTE, LTE-TDD, Digital Cable TV, LTEAFDD, LTEATDD
Remote Command	<code>[:SENSe] :ACPoweR:CARRier[1] 2:RCARrier <integer></code> <code>[:SENSe] :ACPoweR:CARRier[1] 2:RCARrier?</code> <code>[:SENSe] :ACPoweR:CARRier[1] 2:RCARrier:AUTO OFF ON 0 1</code> <code>[:SENSe] :ACPoweR:CARRier[1] 2:RCARrier:AUTO?</code>
Example	ACP:CARR:RCAR 1

	ACP:CARR:RCAR? ACP:CARR:RCAR:AUTO OFF ACP:CARR:RCAR:AUTO?
Notes	<p>Carrier sub op code. 1 for BTS, 2 for MS. Default is BTS.</p> <p>Note that Carrier sub op code 2 is supported only in Non-SA modes.</p> <p>In the SA mode, Carrier sub op code 1 is used for both BTS and MS.</p> <p>You must be in the mode that includes ACP measurements to use this command. Use :INSTrument:SElect to set the mode.</p> <p>For LTE-Advanced FDD/TDD mode, this key is blank. In order to keep backwards compatible with the legacy LTE FDD/TDD, the scpi command is supported in LTE & LTE-A converged application.</p>
Dependencies	If there is only one carrier, this key will be grayed out.
Couplings	<p>If you enter a carrier value that is currently configured as having no power present, that carrier will be changed to having power present.</p> <p>If you enter a ref carrier this parameter will be set to manual.</p>
Preset	Auto determined
State Saved	Saved in instrument state.
Min	1
Max	Number of available carriers
Backwards Compatibility SCPI	[:SENSe] :MCPower:RCARrier [1] 2 (PSA Power Suite)
Initial S/W Revision	Prior to A.02.00
Modified at S/W Revision	A.02.00, A.03.00

Ref Car Freq

Sets the reference carrier frequency.

Key Path	Meas Setup, Carrier Setup
Mode	SA, WCDMA, C2K, WIMAX OFDMA, 1xEVDO, TD-SCDMA, DVB-T/H, DTMB (CTTB), ISDB-T, CMMB, LTE, LTETDD, Digital Cable TV, LTEAFDD, LTEATDD
Remote Command	<pre>[:SENSe] :ACPpower:CARRier [1] 2 :RCFRrequency <freq> [:SENSe] :ACPpower:CARRier [1] 2 :RCFRrequency? [:SENSe] :ACPpower:CARRier [1] 2 :RCFRrequency:AUTO OFF ON 0 1 [:SENSe] :ACPpower:CARRier [1] 2 :RCFRrequency:AUTO?</pre>
Example	<pre>ACP:CARR:RCFR 250 MHz ACP:CARR:RCFR? ACP:CARR:RCFR:AUTO OFF</pre>

ACP:CARR:RCFR:AUTO?

Notes

Carrier sub op code. 1 for BTS, 2 for MS. Default is BTS.
 Note that Carrier sub op code 2 is supported only in Non-SA modes.
 In the SA mode, Carrier sub op code 1 is used for both BTS and MS.
 You must be in the mode that includes ACP measurements to use this command. Use
 :INSTrument:SElect to set the mode.
 For LTE-Advanced FDD/TDD mode, this key is blank. In order to keep backwards compatible with the
 legacy LTE FDD/TDD, the scpi command is supported in LTE & LTE-A converged application

Couplings

LTE-Advanced FDD/TDD not supported the following couplings.
 Coupled to the Center Frequency.
 If the center frequency changes, the Ref Carrier Frequency is calculated using the following three
 steps;

$$\text{Ref Freq1} = \text{Ctr Freq} - (\text{Total of all Carrier Widths} / 2)$$

$$\text{Ref Freq2} = \text{Ref Freq1} + (\text{Total of all Carrier Widths up to Ref Carrier})$$

$$\text{Ref Freq} = \text{Ref Freq2} + (0.5 * \text{Carrier Width of Ref Carrier})$$
 If reference carrier frequency changes the Center Frequency is calculated using the following three
 steps;

$$\text{Ctr Freq1} = \text{Ref Freq} - (0.5 * \text{Carrier Width of Ref Carrier})$$

$$\text{Ctr Freq2} = \text{Ctr Freq1} - (\text{Total of all Carrier Widths up to Ref Carrier})$$

$$\text{Ctr Freq} = \text{Ctr Freq2} + (\text{Total of all Carrier Widths} / 2)$$
 This ensures that the carriers are always centered on the screen.
 If there is only one carrier present the Reference Carrier Frequency will be the same as the Center
 Frequency.

Preset Calculated based on the current Center Frequency

State Saved Saved in instrument state.

Min -79.999995 MHz

Max Hardware Dependent:
 Option F03 = 3.079999995 GHz
 Option F07 = 7.574999995 GHz
 Option F13 = 13.799999995 GHz
 Option F26 = 26.549999995 GHz

Initial S/W Revision Prior to A.02.00

Modified at S/W Revision A.02.00, A.03.00

Power Ref

Sets the power reference in the carrier that will be used to compute the relative values for the offsets.

Key Path	Meas Setup, Carrier Setup
Initial S/W Revision	Prior to A.02.00
Modified at S/W Revision	A.03.00, A.04.00

Total Power

Sets the multi-carrier power reference.

When set to Auto, the carrier power result reflects the measured power value in the selected reference carrier.

When set to Man, the result is referenced to the last measured value, or you may specify the reference for the multi-carrier power measurement. Relative values are displayed, referenced to the “Power Reference” value.

Key Path	Meas Setup, Carrier Setup, Power Ref
Mode	SA, WCDMA, C2K, WIMAX OFDMA, TD-SCDMA, DVB-T/H, DTMB (CTTB), ISDB-T, CMMB, LTE, LTETDD, Digital Cable TV, MSR
Remote Command	[:SENSe]:ACPowEr:CARRier[1] 2[:POWer] <real> [:SENSe]:ACPowEr:CARRier[1] 2[:POWer]? [:SENSe]:ACPowEr:CARRier[1] 2:AUTO[:STATe] OFF ON 0 1 [:SENSe]:ACPowEr:CARRier[1] 2:AUTO[:STATe]?
Example	ACP:CARR 10 ACP:CARR? ACP:CARR:AUTO OFF ACP:CARR:AUTO?
Notes	Although the default value is defined, the value is recalculated by the measurement result just after measurement. Carrier sub op code: 1 for BTS, 2 for MS. Default is BTS. Carrier sub op code 2 is supported only in Non-SA modes. MS is not supported in MSR. In the SA mode, Carrier sub op code 1 is used for both BTS and MS. The Unit Terminator keys differ depending on whether or not the mode supports Y Axis Unit and also which Y Axis Unit is selected. You must be in the mode that includes ACP measurements to use this command. Use :INSTrument:SElect to set the mode. Power Ref State ([:SENSe]:ACPowEr:CARRier[1] 2:AUTO[:STATe]) is not available in MSR mode.
Dependencies	This key is available only when the Meas Type is TPreF. If the Meas Type is not TPreF, this key is grayed out.
Preset	0.0 ON
State Saved	Saved in instrument state.
Min	-200 dBm

Max	200 dBm
Backwards Compatibility SCPI	<code>[:SENSe] :MCPower :CARRier [1] 2 [:POWer]</code>
Initial S/W Revision	Prior to A.02.00
Modified at S/W Revision	A.02.00, A.03.00, A.04.00, A.10.00

PSD

Sets the power spectral density in the carrier (main channel) that is used to compute the relative power spectral density values for the offsets when Meas Type is set to PSD Ref. When the PSD Ref state is set to Auto, this will be set to the measured carrier power spectral density.

Key Path	Meas Setup, Carrier Setup, Power Ref
Mode	SA, WCDMA, C2K, WIMAX OFDMA, TD-SCDMA, DVB-T/H, DTMB (CTTB), ISDB-T, CMMB, LTE, LTETDD, Digital Cable TV, MSR
Remote Command	<code>[:SENSe] :ACPPower :CARRier [1] 2 :CPSD <real></code> <code>[:SENSe] :ACPPower :CARRier [1] 2 :CPSD?</code>
Example	ACP:CARR:CPSD 25 ACP:CARR:CPSD?
Notes	Although the default value is defined, the value is recalculated by the measurement result just after measurement. Carrier sub op code. 1 for BTS, 2 for MS. Default is BTS. MS is not supported in MSR. Note that Carrier sub op code 2 is supported only in Non-SA modes. In the SA mode, Carrier sub op code 1 is used for both BTS and MS. You must be in the mode that includes ACP measurements to use this command. Use :INSTrument:SElect to set the mode.
Dependencies	This key is available only when the Meas Type is PSDRef. If the Meas Type is not PSDRef, this key is grayed out.
Couplings	The value of PSD is automatically converted when PSD Unit is changed.
Preset	0.0
State Saved	Saved in instrument state.
Min	-999
Max	999
Initial S/W Revision	Prior to A.02.00
Modified at S/W Revision	A.02.00, A.03.00, A.04.00, A.10.00

Configure Carriers

Accesses a menu that contains Carrier, Carrier Pwr Present, Carrier Width and Carrier Integ BW parameters.

Key Path	Meas Setup, Carrier Setup
Initial S/W Revision	Prior to A.02.00

Carrier

Selects the carrier to configure for the current measurement.

Key Path	Meas Setup, Carrier Setup, Configure Carriers
Mode	SA, WCDMA, C2K, WIMAX OFDMA, 1xEVDO, TD-SCDMA, DVB-T/H, DTMB (CTTB), ISDB-T, CMMB, LTE, LTEFDD, Digital Cable TV
Couplings	Max value is the number of available carriers, so this value might change when the number of carriers is changed.
Preset	1
State Saved	No
Min	1
Max	Number of available carriers
Initial S/W Revision	Prior to A.02.00
Modified at S/W Revision	A.02.00, A.03.00

Carrier Pwr Present

Configures the carriers for this measurement. It allows spaces to be inserted between carriers. Carriers with the power present parameter set to Yes are carriers, and those with the power present parameter set to No are spaces. Each carrier power present is set to Yes or No. The individual carriers can be set by selecting the desired carrier on the carrier menu key using the up down arrows, the knob, or numeric keypad, then toggling the carrier power present using the carrier power present menu key.

The query for this parameter returns the current values for all of the carriers. If a carrier is defined as having no power present, the power displayed will be relative to the reference carrier, otherwise the absolute power will be displayed.

If you change the carrier power present to no and that carrier is currently configured as the reference carrier, the next carrier to the left (or the right if there are no carriers to the left) will be assigned as the reference carrier. This also applies to the scenario where there are only two carriers configured as having power present and you configure only one carrier to have no power present.

Key Path	Meas Setup, Carrier Setup, Configure Carriers
Mode	SA, WCDMA, C2K, WIMAX OFDMA, 1xEVDO, TD-SCDMA, DVB-T/H, DTMB (CTTB), ISDB-T, CMMB, LTE, LTEFDD, Digital Cable TV, LTEAFDD, LTEATDD

Remote Command	<code>[:SENSe] :ACPower:CARRier [1] 2 :LIST:PPResent YES NO, YES NO, YES NO, YES NO, YES NO, YES NO, YES NO</code> <code>[:SENSe] :ACPower:CARRier [1] 2 :LIST:PPResent?</code>
Example	ACP:CARR2:LIST:PPR YES ACP:CARR2:LIST:PPR?
Notes	Carrier sub op code. 1 for BTS, 2 for MS. Default is BTS. Note that Carrier sub op code 2 is supported only in Non-SA modes. In the SA mode, Carrier sub op code 1 is used for both BTS and MS. When setting these values remotely, the position in the list sent corresponds to the carrier. Missing values are not permitted, therefore if you want to change values 2 and 6 you must send all values up to 6. Subsequent values will remain unchanged, unless the number of values sent is greater than the number of carriers, then subsequent values will be ignored. For LTE-Advanced FDD/TDD mode, this key is blank. In order to keep backwards compatible with the legacy LTE FDD/TDD, the scpi command is supported in LTE & LTE-A converged application.
Dependencies	If there is only one carrier, this key will be grayed out.
Couplings	Coupled to the number of carriers. When the SCPI command is sent, the number of carriers will be set to the number of entries in the parameter list.
Preset	YES
State Saved	Saved in instrument state.
Range	Yes No
Backwards Compatibility SCPI	<code>[:SENSe] :MCPower:CARRier [1] 2 :LIST:PPResent (PSA Power Suite)</code>
Initial S/W Revision	Prior to A.02.00
Modified at S/W Revision	A.02.00, A.03.00

Carrier Spacing

Sets the width of the carrier spacing. This will be the value applied to all the current slots, whether they are carriers or spaces.

Enter each carrier spacing value individually by selecting the desired carrier on the carrier menu key using the up down arrows, the knob, or the numeric keypad, then enter the carrier width using the carrier spacing menu key.

Key Path	Meas Setup, Carrier Setup, Configure Carriers
Mode	SA, WCDMA, C2K, WIMAX OFDMA, 1xEVDO, TD-SCDMA, DVB-T/H, DTMB (CTTB), ISDB-T, CMMB, LTE, LTE-TDD, Digital Cable TV, LTEAFDD, LTEATDD
Remote Command	<code>[:SENSe] :ACPower:CARRier [1] 2 :LIST:WIDTh <freq>, <freq>, <freq>, <freq>, <freq>, <freq></code> <code>[:SENSe] :ACPower:CARRier [1] 2 :LIST:WIDTh?</code>
Example	ACP:CARR2:LIST:WIDT 25kHz ACP:CARR2:LIST:WIDT?

Notes	<p>Carrier sub op code. 1 for BTS, 2 for MS. Default is BTS.</p> <p>Note that Carrier sub op code 2 is supported only in Non-SA modes.</p> <p>In the SA mode, Carrier sub op code 1 is used for both BTS and MS.</p> <p>When setting these values remotely, the position in the list sent corresponds to the carrier. Missing values are not permitted, therefore if you want to change values 2 and 6 you must send all values up to 6. Subsequent values will remain unchanged, unless the number of values sent is greater than the number of carriers, then subsequent values will be ignored.</p> <p>You must be in the mode that includes ACP measurements to use this command. Use :INSTrument:SElect to set the mode.</p> <p>For LTE-Advanced FDD/TDD mode, this key is blank. In order to keep backwards compatible with the legacy LTE FDD/TDD, the scpi command is supported in LTE & LTE-A converged application.</p>
Couplings	<p>Coupled to the number of carriers. When the SCPI command is sent, the number of carriers will be set to the number of entries in the parameter list.</p> <p>Changing Carrier Spacing might affect the Span.</p>
Preset	<p>SA, WCDMA: 5 MHz</p> <p>WIMAX OFDMA: 10 MHz</p> <p>C2K: 1.25 MHz</p> <p>1xEVDO: 1.25 MHz</p> <p>TD-SCDMA: 1.6 MHz</p> <p>DVB-T/H: 8 MHz</p> <p>DTMB (CTTB): 8 MHz</p> <p>ISDB-T: 6 MHz</p> <p>CMMB: 8 MHz</p> <p>LTE: 5 MHz</p> <p>LTETDD: 5 MHz</p> <p>Digital Cable TV: 8 MHz</p>
State Saved	Saved in instrument state.
Min	0 Hz
Max	1 GHz
Backwards Compatibility SCPI	[[:SENSE]:MCPower:CARRIER[1] 2:LIST:WIDTH (PSA Power Suite)
Initial S/W Revision	Prior to A.02.00
Modified at S/W Revision	A.02.00, A.03.00

Measurement Noise Bandwidth

Specifies the Measurement Noise Bandwidth used to calculate the power in the carriers.

Each Measurement Noise Bandwidth value is entered individually by selecting the desired carrier on the carrier menu key using the up down arrows, the knob, or the numeric keypad. Then enter the measurement noise bandwidth using the measurement noise bandwidth key.

Key Path	Meas Setup, Carrier Setup, Configure Carriers
Mode	SA, WCDMA, C2K, WIMAX OFDMA, TD-SCDMA, 1xEVDO, DVB-T/H, DTMB (CTTB), ISDB-T, CMMB, LTE, LTEFDD, Digital Cable TV, LTEAFDD, LTEATDD
Remote Command	<code>[:SENSe]:ACPower:CARRier[1] 2:LIST:BANDwidth[:INTEgration] <freq>, <freq>, <freq>, <freq>, <freq></code> <code>[:SENSe]:ACPower:CARRier[1] 2:LIST:BANDwidth[:INTEgration]?</code>
Example	ACP:CARR2:LIST:BAND 25kHz ACP:CARR2:LIST:BAND?
Notes	In the WCDMA mode, the preset/default value is defined as 3.84 MHz. But internally, 4.6848 MHz is used as the default value. Carrier sub op code. 1 for BTS, 2 for MS. Default is BTS. Note that Carrier sub op code 2 is supported only in Non-SA modes. In the SA mode, Carrier sub op code 1 is used for both BTS and MS. When setting these values remotely, the position in the list sent corresponds to the carrier. Missing values are not permitted, therefore if you want to change values 2 and 6 you must send all values up to 6. Subsequent values will remain unchanged, unless the number of values sent is greater than the number of carriers, then subsequent values will be ignored. You must be in the mode that includes ACP measurements to use this command. Use <code>:INSTrument:SElect</code> to set the mode. For LTE-Advanced FDD/TDD mode, this key is blank. In order to keep backwards compatible with the legacy LTE FDD/TDD, the <code>scpi</code> command is supported in LTE & LTE-A converged application.
Couplings	Coupled to the number of carriers. When the SCPI command is sent, the number of carriers is set to the number of entries in the parameter list.
Preset	SA: 2 MHz WCDMA: 3.84 MHz WIMAX OFDMA: 10 MHz C2K: 1.23MHz TD-SCDMA: 1.28 MHz 1xEVDO: 1.23 MHz DVB-T/H: 7.61 MHz DTMB (CTTB): 7.56 MHz ISDB-T: 5.6 MHz CMMB: 7.512 MHz LTE, LTEFDD: 4.515 MHz 4.5 MHz Digital Cable TV: 8.0 MHz
State Saved	Saved in instrument state.
Min	10 Hz
Max	1 GHz
Backwards Compatibility SCPI	<code>[:SENSe]:ACPower:BANDwidth:INTEgration</code> <code>[:SENSe]:ACPower:BWIDth:INTEgration</code> <code>[:SENSe]:ACPower:CARRier[1] 2:LIST:BWIDth[:INTEgration]</code>

Offset/Limits

Accesses a menu of functions that contains Offset, Offset Freq/Offset To Edge, Offset Integ BW, Upper Offset Limit and Lower Offset parameters.

Key Path	Meas Setup
Initial S/W Revision	Prior to A.02.00
Modified at S/W Revision	A.13.00

Select Offset

Selects the offset to configure.

Key Path	Meas Setup, Offset/Limits, Limits
Mode	SA, WCDMA, C2K, WIMAX OFDMA, TD-SCDMA, 1xEVDO, DVB-T/H, DTMB (CTTB), ISDB-T, CMMB, LTE, LTETDD, Digital Cable TV, MSR, LTEAFDD,LTEATDD
Preset	A
State Saved	Saved in instrument state.
Range	Offset A Offset B Offset C Offset D Offset E Offset F
Initial S/W Revision	Prior to A.02.00
Modified at S/W Revision	A.02.00, A.03.00, A.13.00

Offset Freq

This parameter determines the frequency difference between the center of the main channel and the center of the carrier.

Each Offset Freq state value is entered individually by selecting the desired carrier on the carrier menu key using the up down arrows, RPG or numeric keypad. Then enter the Offset Freq State using the Offset Frequency key.

The list contains up to six (6) entries, depending on the mode selected, for offset frequencies. Each offset frequency in the list corresponds to a reference bandwidth in the bandwidth list.

An offset frequency of zero turns the display of the measurement for that offset off, but the measurement is still made and reported. You can turn off (not use) specific offsets with the [:SENSe]:ACP:OFFSet:LIST:STATe command.

Turning the offset off has the same effect as setting the frequency of the offset to 0 Hz and will cause it to be removed from the results screen.

Key Path	Meas Setup, Offset/Limits
Mode	SA, WCDMA, C2K, WIMAX OFDMA, TD-SCDMA, 1xEVDO, DVB-T/H, DTMB (CTTB), ISDB-T, CMMB, LTE, LTETDD, Digital Cable TV, MSR, LTEAFDD,LTEATDD

Remote Command	<pre>[:SENSe]:ACPower:OFFSet [1] 2[:OUTer]:LIST[:FREQuency] <freq>, <freq>, <freq>, <freq>, <freq>, <freq> [:SENSe]:ACPower:OFFSet [1] 2[:OUTer]:LIST[:FREQuency]? [:SENSe]:ACPower:OFFSet [1] 2[:OUTer]:LIST:STATe OFF ON 0 1, OFF ON 0 1, OFF ON 0 1, OFF ON 0 1, OFF ON 0 1, OFF ON 0 1 [:SENSe]:ACPower:OFFSet [1] 2[:OUTer]:LIST:STATe?</pre>
Example	<pre>ACP:OFFS1:LIST 0,0,0,0,0,0 ACP:OFFS1:LIST? ACP:OFFS2:LIST:STAT 1,1,0,0,0,0 ACP:OFFS2:LIST:STAT?</pre>
Notes	<p>The label for this menu key will change depending on the currently selected radio standard or mode. For cdma2000 the label for the menu key will be Offset to Edge. For all other supported standards the label will be Offset Freq.</p> <p>When setting these values remotely, the position in the list sent corresponds to the offset. Missing values are not permitted, unless the number of values sent is greater than the number of carriers, then subsequent values will be ignored.</p> <p>Offset sub op code. 1 for BTS, 2 for MS. Default is BTS.</p> <p>Note that Offset sub op code 2 is supported only in Non-SA modes.</p> <p>In the SA mode, Offset sub op code 1 is used for both BTS and MS.</p> <p>You must be in the mode that includes ACP measurements to use this command. Use :INSTrument:SElect to set the mode.</p>
Couplings	<p>Changing Offset Frequency might affect the Span. See the Span key section for details.</p>
Preset	<pre>SA: 3 MHz, 0 Hz, 0 Hz, 0 Hz, 0 Hz, 0 Hz 3 MHz, 0 Hz, 0 Hz, 0 Hz, 0 Hz, 0 Hz WCDMA: 5.0 MHz, 10.0 MHz, 0 Hz, 0 Hz, 0 Hz, 0 Hz 5.0 MHz, 10.0 MHz, 0 Hz, 0 Hz, 0 Hz, 0 Hz WIMAX OFDMA: 10 MHz, 20 MHz, 0 Hz, 0 Hz, 0 Hz, 0 Hz 10 MHz, 20 MHz, 0 Hz, 0 Hz, 0 Hz, 0 Hz C2K:750KHz, 1.980 MHz, 0 Hz, 0 Hz, 0 Hz, 0 Hz 885 kHz, 1.980 MHz, 0 Hz, 0 Hz, 0 Hz, 0 Hz TD-SCDMA: 1.6 MHz, 3.2 MHz, 0 Hz, 0 Hz, 0 Hz, 0 Hz 1.6 MHz, 3.2 MHz, 0 Hz, 0 Hz, 0 Hz, 0 Hz 1xEVDO: 750KHz, 1.98MHz, 3.125MHz, 4.000MHz, 7.500MHz, 7.500MHz 885KHz, 1.98MHz, 3.125MHz, 4.000MHz, 7.500MHz, 7.500MHz DVB-T/H: 8 MHz, 16 MHz, 0 Hz, 0 Hz, 0 Hz, 0 Hz 8 MHz, 16 MHz, 0 Hz, 0 Hz, 0 Hz, 0 Hz DTMB (CTTB): 8 MHz, 16 MHz, 24 MHz, 32 MHz, 0 Hz, 0 Hz 8 MHz, 16 MHz, 24 MHz, 32 MHz, 0 Hz, 0 Hz ISDB-T: 6 MHz, 12 MHz, 0 Hz, 0 Hz, 0 Hz, 0 Hz 6 MHz, 12 MHz, 0 Hz, 0 Hz, 0 Hz, 0 Hz CMMB: 8 MHz, 16 MHz, 24 MHz, 32 MHz, 0 Hz, 0 Hz 8 MHz, 16 MHz, 24 MHz, 32 MHz, 0 Hz, 0 Hz LTE, LTETDD, MSR, LTEAFDD, LTEATDD: 5 MHz, 10 MHz, 0, 0, 0, 0 5 MHz, 10 MHz, 0, 0, 0, 0 Digital Cable TV: 8 MHz, 16 MHz, 0 Hz, 0 Hz, 0 Hz, 0 Hz 8 MHz, 16 MHz, 0 Hz, 0 Hz, 0 Hz, 0 Hz SA: ON, OFF, OFF, OFF, OFF, OFF ON, OFF, OFF, OFF, OFF, OFF WCDMA: ON, ON, OFF, OFF, OFF, OFF ON, ON, OFF, OFF, OFF, OFF WIMAX OFDMA: ON, ON, OFF, OFF, OFF, OFF ON, ON, OFF, OFF, OFF, OFF TD-SCDMA: ON, ON, OFF, OFF, OFF, OFF ON, ON, OFF, OFF, OFF, OFF DVB-T/H: ON, ON, OFF, OFF, OFF, OFF ON, ON, OFF, OFF, OFF, OFF</pre>

	DTMB (CTTB): ON, ON, OFF, OFF, OFF, OFF ON, ON, OFF, OFF, OFF, OFF CDMA1xEVDO: ON, ON, OFF, OFF, OFF, OFF ON, ON, OFF, OFF, OFF, OFF ISDB-T: ON, ON, OFF, OFF, OFF, OFF ON, ON, OFF, OFF, OFF, OFF CMMB: ON, ON, ON, ON, OFF, OFF ON, ON, ON, ON, OFF, OFF LTE, LTE-TDD, MSR, LTEAFDD, LTEATDD: ON, ON, OFF, OFF, OFF, OFF ON, OFF, OFF, OFF, OFF, OFF Digital Cable TV: ON, ON, OFF, OFF, OFF, OFF ON, ON, OFF, OFF, OFF, OFF
State Saved	Saved in instrument state.
Min	0 Hz
Max	500 MHz
Backwards Compatibility SCPI	<code>[[:SENSe]:MCPower:OFFSet[1] 2:LIST[:FREQuency]</code> (PSA Power Suite)
Initial S/W Revision	Prior to A.02.00
Modified at S/W Revision	A.02.00, A.03.00, A.13.00

Integ BW

Sets the Integration Bandwidth for the offsets. Each resolution bandwidth in the list corresponds to an offset frequency in the list defined by `[[:SENSe]:ACP:OFFSet[n]:OUTer]:LIST[:FREQuency]`.

Enter each value individually by selecting the desired offset on the offset menu key using the up down arrows, the knob, or the numeric keypad, then enter the Offset Integration Bandwidth using the Offset Integration Bandwidth menu key.

You can turn off (not use) specific offsets with the `[[:SENSe]:ACP:OFFSet[n]:OUTer]:LIST:STATe` command.

Key Path	Meas Setup, Offset/Limits
Mode	SA, WCDMA, C2K, WIMAX OFDMA, TD-SCDMA, 1xEVDO, DVB-T/H, DTMB (CTTB), ISDB-T, CMMB, LTE, LTE-TDD, Digital Cable TV, MSR, LTEAFDD, LTEATDD
Remote Command	<code>[[:SENSe]:ACP:OFFSet[1] 2[:OUTer]:LIST:BANDwidth[:INTEgration]</code> <code><freq>, <freq>, <freq>, <freq>, <freq>, <freq></code> <code>[[:SENSe]:ACP:OFFSet[1] 2[:OUTer]:LIST:BANDwidth[:INTEgration]?</code>
Example	ACP:OFFS2:LIST:BAND 2MHz, 2MHz, 2MHz, 2MHz, 2MHz, 2MHz ACP:OFFS2:LIST:BAND?
Notes	<p>When setting these values remotely, the position in the list sent corresponds to the offset. Missing values are not permitted i.e. if you want to change the second value, you must send all values up to it. Subsequent values will remain unchanged, unless the number of values sent is greater than the number of carriers, then subsequent values will be ignored.</p> <p>Offset sub op code. 1 for BTS, 2 for MS. Default is BTS.</p> <p>Note that Offset sub op code 2 is supported only in Non-SA modes.</p> <p>In the SA mode, Offset sub op code 1 is used for both BTS and MS.</p> <p>You must be in the mode that includes ACP measurements to use this command. Use <code>:INSTrument:SElect</code> to set the mode.</p>

Couplings	Changing Integ BW might affect the Span. See Span section for details.
Preset	SA: 2 MHz, 2 MHz, 2 MHz, 2 MHz, 2 MHz, 2 MHz 2 MHz, 2 MHz, 2 MHz, 2 MHz, 2 MHz, 2 MHz WCDMA: 3.84 MHz, 3.84 MHz, 3.84 MHz, 3.84 MHz, 3.84 MHz, 3.84 MHz 3.84 MHz, 3.84 MHz, 3.84 MHz, 3.84 MHz, 3.84 MHz WIMAX OFDMA: 10 MHz, 10 MHz, 10 MHz, 10 MHz, 10 MHz, 10 MHz 10 MHz, 10 MHz, 10 MHz, 10 MHz, 10 MHz, 10 MHz C2K: 30 kHz, 30 kHz, 30 kHz, 30 kHz, 30 kHz, 30 kHz 30 kHz, 30 kHz, 30 kHz, 30 kHz, 30 kHz, 30 kHz TD-SCDMA: 1.28 MHz, 1.28 MHz, 1.28 MHz, 1.28 MHz, 1.28 MHz, 1.28 MHz 1xEVDO: C2K: 30 kHz, 30 kHz, 30 kHz, 30 kHz, 30 kHz, 30 kHz 30 kHz, 30 kHz, 30 kHz, 30 kHz, 30 kHz, 30 kHz DVB-T/H: 7.61 MHz, 7.61 MHz, 7.61 MHz, 7.61 MHz, 7.61 MHz, 7.61 MHz 7.61 MHz, 7.61 MHz, 7.61 MHz, 7.61 MHz, 7.61 MHz, 7.61 MHz DTMB (CTTB): 7.56 MHz, 7.56 MHz, 7.56 MHz, 7.56 MHz, 7.56 MHz, 7.56 MHz 7.56 MHz, 7.56 MHz, 7.56 MHz, 7.56 MHz, 7.56 MHz, 7.56 MHz ISDB-T: 5.6 MHz, 5.6 MHz, 5.6 MHz, 5.6 MHz, 5.6 MHz, 5.6 MHz 5.6 MHz, 5.6 MHz, 5.6 MHz, 5.6 MHz, 5.6 MHz, 5.6 MHz CMMB: 7.512 MHz, 7.512 MHz, 7.512 MHz, 7.512 MHz, 7.512 MHz, 7.512 MHz 7.512 MHz, 7.512 MHz, 7.512 MHz, 7.512 MHz, 7.512 MHz, 7.512 MHz LTE, LTEFDD, MSR, LTEAFDD, LTEATDD: 4.515 MHz, 4.515 MHz, 4.515 MHz, 4.515 MHz, 4.515 MHz, 4.515 MHz 4.5 MHz, 4.5 MHz, 4.5 MHz, 4.5 MHz, 4.5 MHz, 4.5 MHz Digital Cable TV: 8.0 MHz, 8.0 MHz, 8.0 MHz, 8.0 MHz, 8.0 MHz, 8.0 MHz 8.0 MHz, 8.0 MHz, 8.0 MHz, 8.0 MHz, 8.0 MHz, 8.0 MHz
State Saved	Saved in instrument state.
Min	10 Hz
Max	1 GHz
Backwards Compatibility SCPI	[:SENSe] :ACPower:OFFSet [1] 2 :LIST:BWIDth [:INTEgration] [:SENSe] :ACPR:OFFSet [1] 2 :LIST:BANDwidth [:SENSe] :ACPR:OFFSet [1] 2 :LIST:BWIDth [:SENSe] :MCPower:OFFSet [1] 2 :LIST:BANDwidth [:INTEgration] (PSA Power Suite) [:SENSe] :MCPower:OFFSet [1] 2 :LIST:BWIDth [:INTEgration] (PSA Power Suite)
Initial S/W Revision	Prior to A.02.00
Modified at S/W Revision	A.02.00, A.03.00, A.13.00

Offset BW

Accesses the offset bandwidth menu.

Key Path	Meas Setup, Offset/Limits
Initial S/W Revision	Prior to A.02.00

Res BW

Sets the resolution bandwidth. If an unavailable bandwidth is entered with the numeric keypad, the closest available bandwidth is selected.

Key Path	Meas Setup, Offset/Limits
Mode	SA, WCDMA, C2K, WIMAX OFDMA, TD-SCDMA, 1xEVDO, DVB-T/H, DTMB (CTTB), ISDB-T, CMMB, LTE, LTEFDD, Digital Cable TV, MSR, LTEAFDD, LTEATDD
Remote Command	<pre>[:SENSe]:ACPower:OFFSet [1] 2[:OUTer]:LIST:BANDwidth:RESolution <freq>, <freq>, <freq>, <freq>, <freq> [:SENSe]:ACPower:OFFSet [1] 2[:OUTer]:LIST:BANDwidth:RESolution? [:SENSe]:ACPower:OFFSet [1] 2[:OUTer]:LIST:BANDwidth:RESolution:AUTO ON OFF 1 0, ON OFF 1 0, ON OFF 1 0, ON OFF 1 0, ON OFF 1 0, ON OFF 1 0 [:SENSe]:ACPower:OFFSet [1] 2[:OUTer]:LIST:BANDwidth:RESolution:AUTO?</pre>
Example	<pre>ACP:OFFS2:LIST:BAND:RES 220kHz, 220kHz, 220kHz, 220kHz, 220kHz, 220kHz ACP:OFFS2:LIST:BAND:RES? ACP:OFFS2:LIST:BAND:RES:AUTO 1,1,1,1,1,1 ACP:OFFS2:LIST:BAND:RES:AUTO?</pre>
Notes	<p>Offset sub op code. 1 for BTS, 2 for MS. Default is BTS.</p> <p>Note that Offset sub op code 2 is supported only in Non-SA modes.</p> <p>In the SA mode, Offset sub op code 1 is used for both BTS and MS.</p> <p>You must be in the mode that includes ACP measurements to use this command. Use :INSTrument:SElect to set the mode.</p>
Dependencies	When Meas Method is RBW or FAST, this key is grayed out and disabled. If the key is pressed, an advisory message is generated. If the equivalent remote command is sent, a "Setting conflict" warning is generated.
Couplings	When Res BW Mode is AUTO, this value is exactly same as Res BW under BW key. And when this value is changed by user, Res BW Mode is also changed to Man.
Preset	<pre>SA: 220 kHz, 220 kHz, 220 kHz, 220 kHz, 220 kHz, 220 kHz WCDMA: 100 kHz, 100 kHz, 100 kHz, 100 kHz, 100 kHz, 100 kHz WIMAX OFDMA: 100 kHz, 100 kHz, 100 kHz, 100 kHz, 100 kHz, 100 kHz C2K: Method:RBW 30 kHz Method: IBW C2K: 15 kHz, 15 kHz, 15 kHz, 15 kHz, 15 kHz, 15 kHz 15 kHz, 15 kHz, 15 kHz, 15 kHz, 15 kHz, 15 kHz TD-SCDMA: 30 kHz, 30 kHz, 30 kHz, 30 kHz, 30 kHz, 30 kHz 1xEVDO: 30kHz, 30kHz, 30kHz, 30kHz, 30kHz, 30kHz 30kHz, 30kHz, 30kHz, 30kHz, 30kHz, 30kHz</pre>

	DVB-T/H: 39 kHz, 39 kHz, 39 kHz, 39 kHz, 39 kHz, 39 kHz 39 kHz, 39 kHz, 39 kHz, 39 kHz, 39 kHz, 39 kHz DTMB (CTTB): 39 kHz, 39 kHz, 39 kHz, 39 kHz, 39 kHz, 39 kHz 39 kHz, 39 kHz, 39 kHz, 39 kHz, 39 kHz, 39 kHz ISDB-T: 39 kHz, 39 kHz, 39 kHz, 39 kHz, 39 kHz, 39 kHz 39 kHz, 39 kHz, 39 kHz, 39 kHz, 39 kHz, 39 kHz CMMB: 39 kHz, 39 kHz, 39 kHz, 39 kHz, 39 kHz, 39 kHz 39 kHz, 39 kHz, 39 kHz, 39 kHz, 39 kHz, 39 kHz LTE, LTE-TDD, MSR, LTEAFDD, LTEATDD: 100 kHz, 100 kHz, 100 kHz, 100 kHz, 100kHz, 100 kHz 100 kHz, 100 kHz, 100 kHz, 100 kHz, 100 kHz, 100 kHz Digital Cable TV: 39 kHz, 39 kHz, 39 kHz, 39 kHz, 39 kHz, 39 kHz 39 kHz, 39 kHz, 39 kHz, 39 kHz, 39 kHz, 39 kHz 1, 1, 1, 1, 1, 1
State Saved	Saved in instrument state.
Min	1 Hz
Max	8 MHz
Backwards Compatibility SCPI	[:SENSe] :ACPpower:OFFSet [1] 2 :LIST:BWIDth:RESolution
Initial S/W Revision	Prior to A.02.00
Modified at S/W Revision	A.02.00, A.03.00, A.13.00

Video BW

Enables you to change the analyzer post-detection filter (VBW).

Key Path	Meas Setup, Offset/Limits, Offset BW
Mode	SA, WCDMA, C2K, WIMAX OFDMA, TD-SCDMA, 1xEVDO, DVB-T/H, DTMB (CTTB), ISDB-T, CMMB, LTE, LTE-TDD, Digital Cable TV, MSR, LTEAFDD, LTEATDD
Remote Command	[:SENSe] :ACPpower:OFFSet [1] 2 [:OUTer] :LIST:BWIDth:VIDeo <freq>, <freq>, <freq>, <freq>, <freq> [:SENSe] :ACPpower:OFFSet [1] 2 [:OUTer] :LIST:BWIDth:VIDeo? [:SENSe] :ACPpower:OFFSet [1] 2 [:OUTer] :LIST:BWIDth:VIDeo:AUTO OFF ON 0 1, OFF ON 0 1, OFF ON 0 1, OFF ON 0 1, OFF ON 0 1, OFF ON 0 1 [:SENSe] :ACPpower:OFFSet [1] 2 [:OUTer] :LIST:BWIDth:VIDeo:AUTO?
Example	ACP:OFFS2:LIST:BWIDth:VIDeo 5MHz, 5MHz, 5MHz, 5MHz, 5MHz, 5MHz ACP:OFFS2:LIST:BWIDth:VIDeo? ACP:OFFS2:LIST:BWIDth:VIDeo:AUTO 0,0,0,0,1,1 ACP:OFFS2:LIST:BWIDth:VIDeo:AUTO?
Notes	The values shown in this table reflect the conditions after a Mode Preset. Offset sub op code. 1 for BTS, 2 for MS. Default is BTS. Note that Offset sub op code 2 is supported only in Non-SA modes.

	In the SA mode, Offset sub op code 1 is used for both BTS and MS. You must be in the mode that includes ACP measurements to use this command. Use :INSTrument:SElect to set the mode. .
Dependencies	When Meas Method is RBW or FAST, this key is grayed out and disabled. If the key is pressed, an advisory message is generated. If the equivalent remote command is sent, a "Setting conflict" warning is generated.
Preset	SA: 22 kHz, 22 kHz, 22 kHz, 22 kHz, 22 kHz, 22 kHz WCDMA, WIMAX OFDMA: 1 MHz, 1 MHz, 1 MHz, 1 MHz, 1 MHz, 1 MHz C2K: 150 kHz, 150 kHz, 150 kHz, 150 kHz, 150 kHz, 150 kHz 150 kHz, 150 kHz, 150 kHz, 1150 kHz, 1150 kHz, 150 kHz TD-SCDMA: 300 kHz, 300 kHz, 300 kHz, 300 kHz, 300 kHz, 300 kHz 1xEVDO: 300KHz, 300KHz, 300KHz, 300KHz, 300KHz, 300KHz 300KHz, 300KHz, 300KHz, 300KHz, 300KHz, 300KHz DVB-T/H: 390 kHz, 390 kHz, 390 kHz, 390 kHz, 390 kHz, 390 kHz 390 kHz, 390 kHz, 390 kHz, 390 kHz, 390 kHz, 390 kHz DTMB (CTTB): 390 kHz, 390 kHz, 390 kHz, 390 kHz, 390 kHz, 390 kHz 390 kHz, 390 kHz, 390 kHz, 390 kHz, 390 kHz, 390 kHz ISDB-T: 390 kHz, 390 kHz, 390 kHz, 390 kHz, 390 kHz, 390 kHz 390 kHz, 390 kHz, 390 kHz, 390 kHz, 390 kHz, 390 kHz CMMB: 390 kHz, 390 kHz, 390 kHz, 390 kHz, 390 kHz, 390 kHz 390 kHz, 390 kHz, 390 kHz, 390 kHz, 390 kHz, 390 kHz LTE, LTEFDD, MSR, LTEAFDD, LTEATDD: 1 MHz, 1 MHz, 1 MHz, 1 MHz, 1 MHz, 1 MHz Digital Cable TV: 390 kHz, 390 kHz, 390 kHz, 390 kHz, 390 kHz, 390 kHz 390 kHz, 390 kHz, 390 kHz, 390 kHz, 390 kHz, 390 kHz ON, ON, ON, ON, ON, ON
State Saved	Saved in instrument state.
Min	1 Hz
Max	50 MHz
Backwards Compatibility SCPI	[:SENSe] :ACPower:OFFSet [1] 2 :LIST:BWIDth:VIDeo
Initial S/W Revision	Prior to A.02.00
Modified at S/W Revision	A.02.00, A.03.00, A.13.00

RBW Control

Accesses the resolution bandwidth control menu.

Key Path	Meas Setup, Offset/Limits, Offset BW
Initial S/W Revision	Prior to A.02.00

Limits

Limits key accesses a menu of functions that contains Select Offset, Abs Limit, Rel Limit and Fail Mask parameters.

Key Path	Meas Setup, Offset/Limits
Initial S/W Revision	A.03.00

Select Offset

Selects the offset to configure.

Key Path	Meas Setup, Offset/Limits, Limits
Mode	SA, WCDMA, C2K, WIMAX OFDMA, TD-SCDMA, 1xEVDO, DVB-T/H, DTMB (CTTB), ISDB-T, CMMB, LTE, LTE-TDD, Digital Cable TV, MSR, LTEAFDD, LTEATDD
Preset	A
State Saved	Saved in instrument state.
Range	Offset A Offset B Offset C Offset D Offset E Offset F
Initial S/W Revision	Prior to A.02.00
Modified at S/W Revision	A.02.00, A.03.00, A.13.00

Abs Limit

Enters an absolute limit value, which sets the absolute amplitude levels to test against for each of the custom offsets. The list must contain six (6) entries. If there is more than one offset, the offset closest to the carrier channel is the first one in the list. [:SENSe]:ACP:OFFSet[n][:OUTer]:LIST:TEST selects the type of testing to be done at each offset.

You can turn off (not use) specific offsets with the [:SENSe]:ACP:OFFSet[n][:OUTer]:LIST:STATe command.

The query returns the six (6) sets of real numbers that are the current absolute amplitude test limits.

Key Path	Meas Setup, Offset/Limits, Limits
Mode	SA, WCDMA, C2K, WIMAX OFDMA, TD-SCDMA, 1xEVDO, DVB-T/H, DTMB (CTTB), ISDB-T, CMMB, LTE, LTE-TDD, Digital Cable TV, MSR, LTEAFDD, LTEATDD
Remote Command	[:SENSe]:ACP:OFFSet[1] 2[:OUTer]:LIST:ABSolute <real>, <real>, <real>, <real>, <real>, <real> [:SENSe]:ACP:OFFSet[1] 2[:OUTer]:LIST:ABSolute?
Example	ACP:OFFS2:LIST:ABS -10, -10, -10, -10, -10, -10 ACP:OFFS2:LIST:ABS?
Notes	Offset sub op code. 1 for BTS, 2 for MS. Default is BTS. Note that Offset sub op code 2 is supported only in Non-SA modes. In the SA mode, Offset sub op code 1 is used for both BTS and MS. You must be in the mode that includes ACP measurements to use this command. Use

	:INSTrument:SElect to set the mode.
Couplings	None If current mode is DTMB (CTTB) or CMMB and current device type is Transmitter, the value from position 2 to position 4 are coupled, changing any one will change the others.
Preset	SA: 0dBm, 0 dBm, 0 dBm, 0 dBm, 0 dBm, 0 dBm 0dBm, 0 dBm, 0 dBm, 0 dBm, 0 dBm, 0 dBm WCDMA: 50 dBm, 50 dBm, 50 dBm, 50 dBm, 50 dBm, 50 dBm 50 dBm, 50 dBm, 50 dBm, 50 dBm, 50 dBm, 50 dBm C2K: 50 dBm, 50 dBm, 50 dBm, 50 dBm, 50 dBm, 50 dBm 50 dBm, 50 dBm, 50 dBm, 50 dBm, 50 dBm, 50 dBm WIMAX OFDMA: 50,50,50,50,50,50 TD-SCDMA: 50 dBm, 50 dBm, 50 dBm, 50 dBm, 50 dBm, 50 dBm 50 dBm, 50 dBm, 50 dBm, 50 dBm, 50 dBm, 50 dBm 1xEVDO: -27dBm, -27dBm, -13dBm, -13dBm, -13dBm, -13dBm -27dBm, -27dBm, -13dBm, -13dBm, -13dBm, -13dBm DVB-T/H: 50 dBm, 50 dBm, 50 dBm, 50 dBm, 50 dBm, 50 dBm 50 dBm, 50 dBm, 50 dBm, 50 dBm, 50 dBm, 50 dBm DTMB (CTTB): 11.14 dBm, 11.14dBm, 11.14 dBm, 11.14 dBm, 50 dBm, 50 dBm 11.14 dBm, 11.14 dBm, 11.14 dBm, 11.14 dBm, 50 dBm, 50 dBm ISDB-T: 50 dBm, 50 dBm, 50 dBm, 50 dBm, 50 dBm, 50 dBm 50 dBm, 50 dBm, 50 dBm, 50 dBm, 50 dBm, 50 dBm CMMB: 11.14 dBm, 11.14dBm, 11.14 dBm, 11.14 dBm, 50 dBm, 50 dBm 11.14 dBm, 11.14 dBm, 11.14 dBm, 11.14 dBm, 50 dBm, 50 dBm LTE, LTEFDD, MSR, LTEAFDD, LTEATDD: -8.45, -8.45, -8.45, -8.45, -8.45, -8.45 -50.0, -50.0, -50.0, -50.0, -50.0, -50.0 Digital Cable TV: 50 dBm, 50 dBm, 50 dBm, 50 dBm, 50 dBm, 50 dBm 50 dBm, 50 dBm, 50 dBm, 50 dBm, 50 dBm, 50 dBm
State Saved	Saved in instrument state.
Min	-200.0 dBm
Max	50.0 dBm
Backwards Compatibility SCPI	<code>[[:SENSe]:ACPR:OFFSet[1] 2:LIST:ABSolute (PSA W-CDMA, PSA cdma2000)</code> <code>[[:SENSe]:MCPower:OFFSet[1] 2:LIST:ABSolute (PSA W-CDMA)</code>
Initial S/W Revision	Prior to A.02.00
Modified at S/W Revision	A.02.00, A.03.00, A.13.00

Rel Lim (Car)

Enters a relative limit value for the carrier level. This sets the amplitude levels to test against for the specified offsets.

The amplitude level is relative to the carrier amplitude. If multiple offsets are available, the list contains six (6) entries. The offset closest to the carrier channel is the first one in the list.

`[[:SENSe]:ACP:OFFSet[n]:[:OUTer]:LIST:TEST` selects the type of testing to be done at each offset.

You can turn off (not use) specific offsets with the `[[:SENSe]:ACP:OFFSet[n]:[:OUTer]:LIST:STATe` command.

The query returns the six (6) sets of real numbers that are the current amplitude test limits, relative to the carrier, for each offset.

Offset[n] n = 1 is base station and n = 2 is mobiles. The default is base station (1).

Key Path	Meas Setup, Offset/Limits, Limits,
Mode	SA, WCDMA, C2K, WIMAX OFDMA, TD-SCDMA, 1xEVDO, DVB-T/H, DTMB (CTTB), ISDB-T, CMMB, LTE, LTETDD, Digital Cable TV, MSR, LTEAFDD, LTEATDD
Remote Command	[[:SENSe]:ACPower:OFFSet[1] 2[:OUTer]:LIST:RCARrier <real>, <real>, <real>, <real>, <real>, <real> [:SENSe]:ACPower:OFFSet[1] 2[:OUTer]:LIST:RCARrier?
Example	ACP:OFFS2:LIST:RCAR 0,0,0,0,0,0 ACP:OFFS2:LIST:RCAR?
Notes	Offset sub op code. 1 for BTS, 2 for MS. Default is BTS. Note that Offset sub op code 2 is supported only in Non-SA modes. In the SA mode, Offset sub op code 1 is used for both BTS and MS. You must be in the mode that includes ACP measurements to use this command. Use :INSTRument:SElect to set the mode.
Couplings	None If current mode is DTMB (CTTB) or CMMB and current device type is Transmitter, the value from position 2 to position 4 are coupled, changing any one will change the others.
Preset	SA: -45, -60, 0, 0, 0, 0 -45, -60, 0, 0, 0, 0 WCDMA: -44.2, -49.2, -49.2, -49.2, -49.2, -49.2 -32.2, -42.2, -42.2, -42.2, -42.2, -42.2 C2K: 0, 0, 0, 0, 0, 0 0, 0, 0, 0, 0, 0 WIMAX OFDMA: -50,-60,0,0,0,0 TD-SCDMA: -40, -45, -45, -45, -45, -45 -33, -43, -43, -43, -43, -43 1xEVDO: -45, -55, -55, -55, -55, -55 -45, -55, -55, -55, -55, -55 DVB-T/H: -60, -60, 0, 0, 0, 0 -60, -60, 0, 0, 0, 0 DTMB (CTTB): -45, -60, -60, -60, 50, 50 -45, -60, -60, -60, 50, 50 ISDB-T: -60, -60, 0, 0, 0, 0 -60, -60, 0, 0, 0, 0 CMMB: -45, -60, -60, -60, 50, 50 -45, -60, -60, -60, 50, 50 LTE, LTETDD, MSR, LTEAFDD, LTEATDD: -44.2, -44.2, -44.2, -44.2, -44.2, -44.2 -29.2, -29.2, -29.2, -29.2, -29.2, -29.2 Digital Cable TV: -58, -62, -65, -73, -73, -73 -58, -62, -65, -73, -73, -73
State Saved	Saved in instrument state.
Min	-150
Max	50.0
Backwards Compatibility SCPI	[[:SENSe]:MCPower:OFFSet[1] 2:LIST:RCARrier (PSA WCDMA)
Initial S/W Revision	Prior to A.02.00
Modified at S/W Revision	A.02.00, A.03.00, A.04.00, A.13.00

Positive Offset Limit (SCPI only)

Enables you to set the upper limit for the upper segment of the specified offset pair.

Mode	SA, WCDMA, CDMA2K, WIMAXOFDMA, TDSCDMA, CDMA1XEV, DVB, DTMB, LTE, LTETDD, DCATV, MSR, LTEAFDD, LTEATDD
Remote Command	:CALCulate:ACPower:OFFSet[:OUTer]:LIST:LIMit:POSitive[:UPPer]:DATA <real>, <real>, <real>, <real>, <real>, <real> :CALCulate:ACPower:OFFSet[:OUTer]:LIST:LIMit:POSitive[:UPPer]:DATA?
Example	CALC:ACP:OFFS:LIST:LIM:POS:DATA 0, 0, 0, 0, 0 CALC:ACP:OFFS:LIST:LIM:POS:DATA?
Notes	SCPI only command
Preset	SA: -45, -60, 0, 0, 0, 0 -45, -60, 0, 0, 0, 0 WCDMA: -44.2, -49.2, -49.2, -49.2, -49.2, -49.2 -32.2, -42.2, -42.2, -42.2, -42.2, -42.2 C2K: 0, 0, 0, 0, 0, 0 0, 0, 0, 0, 0, 0 WIMAX OFDMA: -50, -60, 0, 0, 0, 0 TD-SCDMA: -40, -45, -45, -45, -45, -45 -33, -43, -43, -43, -43, -43 1xEVDO: -45, -55, -55, -55, -55, -55 -45, -55, -55, -55, -55, -55 DVB-T/H: -60, -60, 0, 0, 0, 0 -60, -60, 0, 0, 0, 0 DTMB (CTTB): -45, -60, -60, -60, 0, 0 -45, -60, -60, -60, 0, 0 Digital Cable TV: -58, -62, -65, -73, -73, -73 -58, -62, -65, -73, -73, -73 LTE, LTETDD, MSR, LTEAFDD, LTEATDD: -44.2, -44.2, -44.2, -44.2, -44.2, -44.2 -29.2, -29.2, -29.2, -29.2, -29.2, -29.2
State Saved	Saved in instrument state.
Min	-150.0
Max	50.0
Backwards Compatibility SCPI	:CALCulate:MCPower:OFFSet:LIST:LIMit:POSitive[:UPPer]:DATA (PSA Power Suite)
Initial S/W Revision	A.04.00
Modified at S/W Revision	A.13.00

Negative Offset Limit

Enables you to set the upper limit for the lower segment of the specified offset pair.

Mode	SA, WCDMA, CDMA2K, WIMAXOFDMA, TDSCDMA, CDMA1XEV, DVB, DTMB, LTE, LTETDD, DCATV, MSR, LTEAFDD, LTEATDD
Remote Command	:CALCulate:ACPower:OFFSet[:OUTer]:LIST:LIMit:NEGative[:UPPer]:DATA <real>, <real>, <real>, <real>, <real>, <real> :CALCulate:ACPower:OFFSet[:OUTer]:LIST:LIMit:NEGative[:UPPer]:DATA?
Example	CALC:ACP:OFFS:LIST:LIM:NEG:DATA 0, 0, 0, 0, 0, 0 CALC:ACP:OFFS:LIST:LIM:NEG:DATA?

Notes	SCPI only command
Preset	SA: -45, -60, 0, 0, 0, 0 -45, -60, 0, 0, 0, 0 WCDMA: -44.2, -49.2, -49.2, -49.2, -49.2, -49.2 -32.2, -42.2, -42.2, -42.2, -42.2, -42.2 C2K: 0, 0, 0, 0, 0, 0 0, 0, 0, 0, 0, 0 WIMAX OFDMA: -50, -60, 0, 0, 0, 0 TD-SCDMA: -40, -45, -45, -45, -45, -45 -33, -43, -43, -43, -43, -43 1xEVDO: -45, -55, -55, -55, -55, -55 -45, -55, -55, -55, -55, -55 DVB-T/H: -60, -60, 0, 0, 0, 0 -60, -60, 0, 0, 0, 0 DTMB (CTTB): -45, -60, -60, -60, 0, 0 -45, -60, -60, -60, 0, 0 Digital Cable TV: -58, -62, -65, -73, -73, -73 -58, -62, -65, -73, -73, -73 LTE, LTETDD, MSR, LTEAFDD, LTEATDD: -44.2, -44.2, -44.2, -44.2, -44.2, -44.2 -29.2, -29.2, -29.2, -29.2, -29.2, -29.2
State Saved	Saved in instrument state.
Min	-150.0
Max	50.0
Backwards Compatibility SCPI	:CALCulate:MCPower:OFFSet:LIST:LIMit:NEGative[:UPPer]:DATA (PSA Power Suite)
Initial S/W Revision	A.04.00
Modified at S/W Revision	A.13.00

Rel Limit (PSD)

Enters a relative limit value for the level of the power spectral density. This sets the amplitude levels to test against for any custom offsets. The amplitude level is relative to the power spectral density. If multiple offsets are available, the list contains six (6) entries. The offset closest to the carrier channel is the first one in the list.

[[:SENSe]:ACP:OFFSet[n]:OUTer]:LIST:TEST selects the type of testing to be done at each offset.

You can turn off (not use) specific offsets with the [[:SENSe]:ACP:OFFSet[n]:OUTer]:LIST:STATe command.

The query returns the six (6) sets of real numbers that are the current amplitude test limits, relative to the power spectral density, for each offset.

Offset[n] n = 1 is base station and n = 2 is mobiles. The default is base station (1).

Key Path	Meas Setup, Offset/Limits, Limits
Mode	SA, WCDMA, C2K, WIMAX OFDMA, TD-SCDMA, 1xEVDO, DVB-T/H, DTMB (CTTB), ISDB-T, CMMB, LTE, LTETDD, Digital Cable TV, MSR, LTEAFDD, LTEATDD
Remote Command	[[:SENSe]:ACP:OFFSet[1] 2[:OUTer]:LIST:RPSDensity <rel_ampl>, <rel_ampl>, <rel_ampl>, <rel_ampl>, <rel_ampl>, <rel_ampl> [[:SENSe]:ACP:OFFSet[1] 2[:OUTer]:LIST:RPSDensity?
Example	ACP:OFFS2:LIST:RPSD 10,10,10,10,10,10 ACP:OFFS2:LIST:RPSD?

Notes	<p>Offset sub op code. 1 for BTS, 2 for MS. Default is BTS.</p> <p>Note that Offset sub op code 2 is supported only in Non-SA modes.</p> <p>In the SA mode, Offset sub op code 1 is used for both BTS and MS.</p> <p>You must be in the mode that includes ACP measurements to use this command. Use :INSTrument:SElect to set the mode.</p>
Preset	<p>SA: -28.87 dB, -43.87 dB, 0 dB, 0 dB, 0 dB -28.87 dB, -43.87 dB, 0 dB, 0 dB, 0 dB, 0 dB</p> <p>WCDMA: -44.2 dB, -49.2 dB, -49.2 dB, -49.2 dB, -49.2 dB, -49.2 dB -32.2 dB, -42.2 dB, -42.2 dB, -42.2 dB, -42.2 dB, -42.2 dB</p> <p>C2K: 0 dB, 0 dB, 0 dB, 0 dB, 0 dB, 0 dB 0 dB, 0 dB, 0 dB, 0 dB, 0 dB, 0 dB</p> <p>WIMAX OFDMA: -25,-35,0,0,0,0</p> <p>TD-SCDMA: -40 dB, -45 dB, -45 dB, -45 dB, -45 dB, -45 dB -33 dB, -43 dB, -43 dB, -43 dB, -43 dB, -43 dB</p> <p>1xEVDO: -45, -55, -55, -55, -55, -55 -45, -55, -55, -55, -55, -55</p> <p>DVB-T/H: -60 dB, -60 dB, 0 dB, 0 dB, 0 dB, 0 dB -60 dB, -60 dB, 0 dB, 0 dB, 0 dB, 0 dB</p> <p>DTMB (CTTB): 50 dB, 50 dB, 50 dB, 50 dB, 50 dB, 50 dB 50 dB, 50 dB, 50 dB, 50 dB, 50 dB, 50 dB</p> <p>ISDB-T: -60 dB, -60 dB, 0 dB, 0 dB, 0 dB, 0 dB -60 dB, -60 dB, 0 dB, 0 dB, 0 dB, 0 dB</p> <p>CMMB: 50 dB, 50 dB, 50 dB, 50 dB, 50 dB, 50 dB 50 dB, 50 dB, 50 dB, 50 dB, 50 dB, 50 dB</p> <p>LTE, LTE-TDD, MSR, LTE-AFDD, LTE-A-TDD: 0, 0, 0, 0, 0, 0 0, 0, 0, 0, 0, 0</p> <p>Digital Cable TV: 50 dB, 50 dB, 50 dB, 50 dB, 50 dB, 50 dB 50 dB, 50 dB, 50 dB, 50 dB, 50 dB, 50 dB</p>
State Saved	Saved in instrument state.
Min	-150.0 dB
Max	50.0 dB
Initial S/W Revision	Prior to A.02.00
Modified at S/W Revision	A.02.00, A.03.00, A.13.00

Fail Mask

Accesses a menu that enables you to select one of the logic keys for the fail conditions between the measurement results and the test limits. The setting defines the type of testing to be done at any custom offset frequencies. The measured powers are tested against the absolute values defined with [:SENSe]:ACP:OFFSet[n][:OUTer]:LIST:ABSolute, or the relative values defined with [:SENSe]:ACP:OFFSet[n][:OUTer]:LIST:RPSDensity and [:SENSe]:ACP:OFFSet[n][:OUTer]:LIST:RCARrier.

You can turn off (not use) specific offsets with the [:SENSe]:ACP:OFFSet[n][:OUTer]:LIST:STATe command.

- Absolute – Fail is shown if one of the absolute ACP measurement results is larger than the limit for Abs Limit.
- Relative – Fail is shown if one of the relative ACP measurement results is larger than the limit for Rel Lim (Car) or Rel Lim (PSD).
- Abs AND Rel – Fail is shown if one of the absolute ACP measurement results is larger than the limit for Abs Limit AND one of the relative ACP measurement results is larger than the limit for Rel Lim (Car) or Rel Lim (PSD).

- Abs OR Rel– Fail is shown if one of the absolute ACP measurement results is larger than the limit for Abs Limit OR one of the relative ACP measurement results is larger than the limit for Rel Lim (Car) or Rel Lim (PSD).

Key Path	Meas Setup, Offset/Limits, Limits
Mode	SA, WCDMA, C2K, WIMAX OFDMA, TD-SCDMA, 1xEVDO, DVB-T/H, DTMB (CTTB), ISDB-T, CMMB, LTE, LTEFDD, Digital Cable TV, MSR, LTEAFDD, LTEATDD
Remote Command	[:SENSe]:ACPower:OFFSet[1] 2[:OUTer]:LIST:TEST ABSolute AND OR RELative, ABSolute AND OR RELative, ABSolute AND OR RELative, ABSolute AND OR RELative, ABSolute AND OR RELative, ABSolute AND OR RELative [:SENSe]:ACPower:OFFSet[1] 2[:OUTer]:LIST:TEST?
Example	ACP:OFFS2:LIST:TEST ABS, ABS, ABS, ABS, ABS, ABS ACP:OFFS2:LIST:TEST?
Notes	Offset sub op code. 1 for BTS, 2 for MS. Default is BTS. Note that Offset sub op code 2 is supported only in Non-SA modes. In the SA mode, Offset sub op code 1 is used for both BTS and MS. You must be in the mode that includes ACP measurements to use this command. Use :INSTrument:SElect to set the mode.
Couplings	None If current mode is DTMB (CTTB) or CMMB and current device type is Transmitter, the value from position 2 to position 4 are coupled, changing any one will change the others.
Preset	SA, WCDMA, C2K, TD-SCDMA: REL, REL, REL, REL, REL, REL REL, REL, REL, REL, REL, REL WIMAX OFDMA: REL, REL, REL, REL, REL, REL DVB-T/H: REL, REL, REL, REL, REL, REL DTMB (CTTB): OR,AND, AND,AND, REL, REL CDMA1xEVDO: REL, REL, ABS, REL, REL, REL REL, REL, ABS, REL, REL, REL ISDB-T : REL, REL, REL, REL, REL, REL CMMB : OR,AND, AND,AND, REL, REL LTE, LTEFDD, MSR, LTEAFDD, LTEATDD: AND, AND, AND, AND, AND, AND AND, AND, AND, AND, AND, AND Digital Cable TV: REL, REL, REL, REL, REL, REL
State Saved	Saved in instrument state.
Range	Absolute Relative Abs AND Rel (fail if both fail) Abs OR Rel (fail if either fails)
Backwards Compatibility SCPI	[:SENSe]:MCPower:OFFSet[1] 2:LIST:TEST
Initial S/W Revision	Prior to A.02.00
Modified at S/W Revision	A.02.00, A.03.00, A.04.00, A13.00

Offset Side

Enables you to turn off (not use) specific offsets with [:SENSe]:ACPower:OFFSet[1]|2[:Outer]:LIST:SIDE.

- NEGative - Negative (lower) sideband only

- BOTH - Both of the negative (lower) and positive (upper) sidebands
- POSitive - Positive (upper) sideband only

The figure below shows the relation between the negative/positive offset side setups and the upper/lower results in the MSR and LTE-Advanced FDD/TDD.

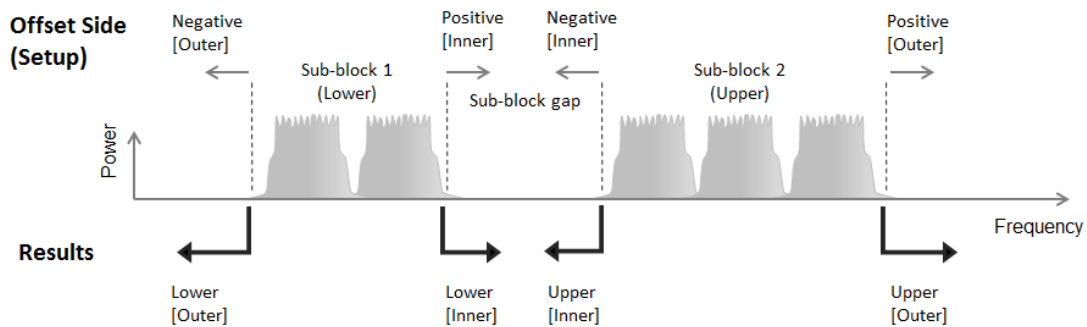

Key Path	Meas Setup, Offset/Limits
Mode	SA, WCDMA, C2K, WIMAX OFDMA, TD-SCDMA, 1xEVDO, DTMB (CTTB), DVB-T/H, LTE, LTETDD, Digital Cable TV, MSR,LTEAFDD,LTEATDD
Remote Command	<code>[[:SENSE]:ACPower:OFFSet[1] 2[:OUTer]:LIST:SIDE NEGative BOTH POSitive,NEGative BOTH POSitive,NEGative BOTH POSitive,NEGative BOTH POSitive,NEGative BOTH POSitive</code> <code>[[:SENSe]:ACPower:OFFSet[1] 2[:OUTer]:LIST:SIDE?</code>
Example	<code>ACP:OFFS:LIST:SIDE BOTH</code> <code>ACP:OFFS:LIST:SIDE?</code>
Notes	OFFSet1 is for BTS, 2 for MS. Default is BTS. You must be in the Spectrum Analysis mode, W-CDMA mode, cdma2000 mode, TD-SCDMA mode, DTMB (CTTB) mode, DVB-T/H mode, ISDB-T mode, CMMB mode, Digital Cable TV mode, 1xEVDO mode, WIMAX OFDMA mode, LTE mode, LTETDD ,LTEAFDD,LTEATDD or MSR mode to use this command. Use :INSTRument:SElect to set the mode. If you set POS or NEG in an offset, result of the inactive side will return -999.
Preset	BOTH, BOTH, BOTH, BOTH, BOTH, BOTH BOTH, BOTH, BOTH, BOTH, BOTH, BOTH
State Saved	Saved in instrument state.
Range	Neg Both Pos
Initial S/W Revision	A.03.00
Modified at S/W Revision	A.13.00

Offset Frequency Define

This key allows you to select “Offset” definition. Each standard defines each “Offset” from Carrier.

3GPP2 requires the “From Carrier Center to MeasBW Closer Edge” definition. LTE conformance test requires “From Carrier Edge to MeasBW Center” and/or “From Carrier Edge to MeasBW Closer Edge” definition.

- CTOCenter – From the center of the carrier closest to the adjacent channel to the center of the adjacent channel Offset Integ BW
- CTOEdge - From the center of the carrier closest to the adjacent channel to the edge of the closest adjacent channel Offset Integ BW
- ETOCenter – From Center Frequency - Carrier Spacing / 2 (for lower offset), Center Frequency + Carrier Spacing / 2 (for upper offset) of the carrier closest to the adjacent channel's to the center of the adjacent channel Offset Integ BW
- ETOEdge - From Center Frequency - Carrier Spacing / 2 (for lower offset), Center Frequency + Carrier Spacing / 2 (for upper offset) of the carrier closest to the adjacent channel's to the edge of the closest adjacent channel Offset Integ BW

Key Path	Meas Setup, Offset/Limits
Mode	SA, WCDMA, C2K, WIMAX OFDMA, TD-SCDMA, 1xEVDO, DVB-T/H, DTMB (CTTB), ISDB-T, CMMB, LTE, LTETDD, Digital Cable TV, MSR, LTEAFDD, LTEATDD
Remote Command	[:SENSe] :ACPpower:OFFSet [1] 2 [:OUTer] :TYPE CTOCenter CTOEdge ETOCenter ETOEdge [:SENSe] :ACPpower:OFFSet [1] 2 [:OUTer] :TYPE?
Example	ACP:OFFS:TYPE ETOC ACP:OFFS:TYPE?
Notes	You must be in the mode that includes ACP measurements to use this command. Use :INSTrument:SElect to set the mode.
Preset	All Except C2K and 1xEVDO: CTOCenter C2K and 1xEVDO: CTOEdge
State Saved	Saved in instrument state.
Range	Carrier Center To Meas BW Center Carrier Center To Meas BW Edge Carrier Edge To Meas BW Center Carrier Edge To Meas BW Edge
Initial S/W Revision	A.03.00
Modified at S/W Revision	A.13.00

Carrier Result

Allows you to view and scroll through the carrier power results.

Key Path	Meas Setup
Mode	SA, WCDMA, C2K, WIMAX OFDMA, TD-SCDMA, 1xEVDO, DVB-T/H, DTMB (CTTB), ISDB-T, CMMB, LTE, LTETDD, Digital Cable TV, MSR, LTEAFDD, LTEATDD
Couplings	This key will be grayed out if there is only one carrier.
Preset	1
State Saved	No
Min	1
Max	Number of carriers.

Initial S/W Revision	Prior to A.02.00
Modified at S/W Revision	A.02.00, A.03.00

Meas Method

Sets the desired method to measure ACP.

Integration BW – one sweep of the trace is taken, and the band power for each offset is computed. Depending on the status of the Meas Type parameter (Total Power Reference or PSD Reference), results are displayed relative to the total power or the power spectral density. The display reflects either the current trace or a bar graph view.

Filtered IBW (max dynamic range) – the ACP Path is used to compute ACP when an ACP path is available. This method increases dynamic range, but increases measurement time as it limits the resolution bandwidth. This method is useful for improving dynamic range on a W-CDMA signal because a sharp cutoff bandpass filter is used. The accuracy of the adjacent channel power ratio is not degraded by this method, but the absolute accuracy of both adjacent channel power and carrier power are degraded by up to about 0.5 dB.

RBW – the algorithm uses zero-span and an appropriate RBW setting to capture all of the power in the carrier channel and the offsets. The zero-span algorithm (RBW method) is slower than the IBW method, but greatly improves repeatability.

Fast (in WCDMA mode or SA mode with 3GPP WCDMA radio standard selected) – this provides the same method as the Integration BW method, but is optimized for speed to measure a W-CDMA signal.

Fast (in CDMA2K mode or SA mode with CDMA2K radio standard selected) – this provides faster measurement using the FFT method with a limited parameter flexibility. When this is selected, CDMA2K preset offsets are given and control of the following are grayed out:

BW menu, Sweep/Control menu except Pause/Resume, Trace/Detector menu, Carrier Setup, Offset Limit, RRC Weighting, Filter Alpha, and Noise Correction softkeys in Meas Setup menu.

Key Path	Meas Setup
Mode	SA, WCDMA, C2K, WIMAX OFDMA, 1xEVDO, DVB-T/H, DTMB (CTTB), ISDB-T, CMMB, LTE, LTETDD, Digital Cable TV, MSR,, LTEAFDD, LTEATDD
Remote Command	[:SENSe] :ACPower:METhod IBW IBWRange FAST RBW [:SENSe] :ACPower:METhod?
Example	ACP:METh IBW ACP:METh?
Notes	FAST mode is only supported for WCDMA and C2K signal. You must be in the WCDMA or C2K mode or SA mode with 3GPP WCDMA or CDMA2K radio standard. Otherwise a setting conflict error message will be reported. In the TDSCDMA mode, only the IBW method is available to use. Therefore, the measure method key is not displayed in the TD-SCDMA mode. CDMA1xEVDO mode only supports RBW and Integration BW method.

	<p>C2K mode only supports RBW, Integration BW and FAST method. LTETDD mode only supports Integration BW and Filtered IBW method. MSR mode only supports Integration BW and Filtered IBW method. LTE-Advanced FDD/TDD mode only support IBW and Filtered IBW method. You must be in the mode that includes ACP measurements to use this command. Use :INSTrument:SElect to set the mode.</p>
Dependencies	<p>When RBW or FAST is selected, Gate function is not available. If you try to turn Gate On while Meas Method is RBW or FAST, an error is generated. When Gate function is ON, RBW and FAST method is not available. If you try to change Meas Method to RBW or FAST, an error is generated.</p>
Couplings	<p>IBW (Range) restricts the Res BW available for making this measurement to 30 kHz. When selected, the Res BW is clipped to this value if required and an error number displayed.</p>
Preset	<p>SA, LTE, LTETDD, MSR, LTEAFDD, LTEATDD: IBW WCDMA: IBW C2K: RBW WIMAX OFDMA: IBW 1xEVDO: IBW DVB-T/H: IBW DTMB (CTTB): IBW ISDB-T: IBW CMMB: IBW Digital Cable TV: IBW</p>
State Saved	<p>Saved in instrument state.</p>
Range	<p>Integration BW Filtered IBW (max dynamic range) RBW Fast</p>
Readback Text	<p>IBW Filtered IBW RBW Fast</p>
Backwards Compatibility SCPI	<p>[:SENSe] :ACPR :SWEep :TYPE [:SENSe] :MCPower :METHod (PSA Power Suite)</p>
Initial S/W Revision	<p>Prior to A.02.00</p>
Modified at S/W Revision	<p>A.02.00, A.03.00</p>

Meas Type

Changes the reference used for the measurement. This allows you to make absolute and relative power measurements of either total power or the power normalized to the measurement bandwidth.

Total Pwr Ref (TPR) sets the reference to the total carrier power. PSD Ref (PSDR) sets the reference to the power spectral density of the carrier.

Key Path	Meas Setup
Mode	SA, WCDMA, C2K, WIMAX OFDMA, TD-SCDMA, 1xEVDO, DVB-T/H, DTMB (CTTB), ISDB-T, CMMB, LTE, LTETDD, Digital Cable TV, MSR, LTEAFDD, LTEATDD

Remote Command	<code>[:SENSe] :ACPower :TYPE TPreRef PSDRef</code> <code>[:SENSe] :ACPower :TYPE?</code>
Example	ACP:TYPE PSDR ACP:TYPE?
Notes	You must be in the mode that includes ACP measurements to use this command. Use :INSTrument:SElect to set the mode.
Preset	TPreRef
State Saved	Saved in instrument state.
Range	Total Power Ref PSD Ref
Initial S/W Revision	Prior to A.02.00
Modified at S/W Revision	A.02.00, A.03.00

PSD Ref

Sets the unit bandwidth for Power Spectral Density. The available units are dBm/Hz and dBm/MHz.

Key Path	Meas Setup
Mode	A, WCDMA, C2K, WIMAX OFDMA, TD-SCDMA, 1xEVDO, DVB-T/H, DTMB (CTTB), ISDB-T, CMMB, LTE, LTE-TDD, Digital Cable TV, MSR, LTEAFDD, LTEATDD
Remote Command	<code>:UNIT:ACPower:POWer:PSD DBMHZ DBMMHZ</code> <code>:UNIT:ACPower:POWer:PSD?</code>
Example	UNIT:ACP:POW:PSD DBMMHZ UNIT:ACP:POW:PSD?
Couplings	When the PSD unit is changed, the PSD reference result of the “MEAS READ FETCH:ACP[n]?” is also changed by the PSD unit basis (in either dBm/Hz or dBm/MHz).
Preset	DBMHZ
State Saved	Saved in instrument state.
Range	dBm/Hz dBm/MHz
Initial S/W Revision	Prior to A.02.00
Modified at S/W Revision	A.02.00, A.03.00

Limit Test

Turns limit checking for each offset On or Off. The limits may be specified within the Offset menu, for each offset, both sides of the carrier. For results that fail the limit, a red F is appended. In the Combined view, the bar turns red.

Key Path	Meas Setup
Mode	SA, WCDMA, C2K, WIMAX OFDMA, TD-SCDMA, 1xEVDO, DVB-T/H, DTMB (CTTB), ISDB-T, CMMB, LTE, LTE-TDD, Digital Cable TV, MSR, LTEAFDD, LTEATDD

Remote Command	:CALCulate:ACPower:LIMit:STATe OFF ON 0 1 :CALCulate:ACPower:LIMit:STATe?
Example	CALC:ACP:LIM:STAT OFF CALC:ACP:LIM:STAT?
Notes	You must be in the mode that includes ACP measurements to use this command. Use :INSTrument:SElect to set the mode.
Preset	SA: OFF WCDMA: ON C2K: ON WIMAX OFDMA: OFF TD-SCDMA: ON 1xEVDO: ON DVB-T/H: OFF DTMB (CTTB): ON ISDB-T: OFF CMMB: ON LTE, LTETDD, MSR, LTEAFDD, LTEATDD: ON Digital Cable TV: OFF
State Saved	Saved in instrument state.
Range	On Off
Backwards Compatibility SCPI	[:SENSe] :MCPower:LIMit [:STATe] [:SENSe] :ACPower:LIMit [:STATe]
Initial S/W Revision	Prior to A.02.00
Modified at S/W Revision	A.02.00, A.03.00

Meas Preset

Restores all the measurement parameters to their default values.

Key Path	Meas Setup
Mode	SA, WCDMA, C2K, WIMAX OFDMA, TD-SCDMA, 1xEVDO, DVB-T/H, DTMB (CTTB), ISDB-T, CMMB, LTE, LTETDD, Digital Cable TV, MSR, LTEAFDD, LTEATDD
Remote Command	:CONFigure:ACPower
Example	CONF:ACP
Notes	You must be in the mode that includes ACP measurements to use this command. Use :INSTrument:SElect to set the mode.
Couplings	Selecting Meas Preset will restore all measurement parameters to their default values.
Initial S/W Revision	Prior to A.02.00
Modified at S/W Revision	A.02.00, A.03.00

Offset RRC Weighting (Backward Compatibility SCPI)

Mode	SA, WCDMA, TD-SCDMA, WIMAX OFDMA, DVB-T/H, DTMB (CTTB), ISDB-T, CMMB, LTE, LTETDD, Digital Cable TV, MSR, LTEAFDD,LTEATDD
Remote Command	<code>[:SENSe] :ACPower :FILTer [:RRC] [:STATe] OFF ON 0 1</code> <code>[:SENSe] :ACPower :FILTer [:RRC] [:STATe] ?</code>
Example	ACP:FILT OFF ACP:FILT?
Notes	This parameter is not available for cdma2000 and 1xEVDO The backwards Compatibility SCPI command, <code>[:SENSe] :ACPR :FILTer [:RRC] [:STATe]</code> , is provided to support same functionality as <code>[:SENSe] :ACPr :FILTer [:RRC] [:STATe]</code> (PSA W-CDMA, PSA cdma2000 and PSA 1xEVDO) due to ACPr node conflicts with ACPower node. You must be in the mode that includes ACP measurements to use this command. Use <code>:INSTRument:SElect</code> to set the mode.
Couplings	This command is an alias to <code>[:SENSe] :ACPower :OFFSet [1] 2 :LIST :FILTer [:RRC] [:STATe]</code> Sending the commands to set values of all offsets for BS and MS, however, sending the query always return a value of BS Offset A.
Preset	SA, WIMAX OFDMA, LTE, LTETDD, MSR: OFF WCDMA: ON C2K: NO TD-SCDMA: ON DVB-T/H: OFF DTMB (CTTB):ON ISDB-T: OFF CMMB: OFF Digital Cable TV: ON LTEAFDD,LTEATDD: OFF
State Saved	Saved in instrument state.
Backwards Compatibility SCPI	<code>[:SENSe] :ACPR :FILTer [:RRC] [:STATe]</code> <code>[:SENSe] :MCPower :FILTer [:RRC] [:STATe]</code>
Initial S/W Revision	Prior to A.02.00
Modified at S/W Revision	A.03.00

Offset Filter Alpha (Backward Compatibility SCPI)

Mode	SA, WCDMA, WIMAX OFDMA, TD-SCDMA, DVB-T/H, DTMB (CTTB), ISDB-T, CMMB, LTE, LTETDD, Digital Cable TV, MSR, LTEAFDD,LTEATDD
Remote Command	<code>[:SENSe] :ACPower :FILTer [:RRC] :ALPHa <real></code> <code>[:SENSe] :ACPower :FILTer [:RRC] :ALPHa?</code>

Example	ACP:FILT:ALPH 0.5 ACP:FILT:ALPH?
Notes	This parameter is not available for cdma2000 and 1xEVDO The backwards Compatibility SCPI command, [:SENSe]:ACPR:FILTer[:RRC]:ALPHa, is provided to support same functionality as [:SENSe]:ACP:FILTer[:RRC]:ALPHa (PSA W-CDMA, PSA cdma2000 and PSA 1xEVDO) due to ACPr node conflicts with ACPower node. You must be in the mode that includes ACP measurements to use this command. Use :INSTrument:SElect to set the mode.
Couplings	This command is an alias to [:SENSe]:ACP:OFFSet[1]2:LIST:FILTer:ALPHa Sending the commands to set values of all offsets for BS and MS, however, sending the query always return a value of BS Offset A.
Preset	SA, WCDMA, WIMAX OFDMA, TD-SCDMA, DVB-T/H, ISDB-T, CMMB, LTE, LTETDD, MSR: 0.22 C2K: NO DTMB (CTTB): 0.05 Digital Cable TV: 0.15 LTEAFDD,LTEATDD: 0.22
State Saved	Saved in instrument state.
Min	0.01
Max	1.00
Backwards Compatibility SCPI	[:SENSe]:ACPR:FILTer[:RRC]:ALPHa [:SENSe]:MCPower:FILTer[:RRC]:ALPHa
Initial S/W Revision	Prior to A.02.00
Modified at S/W Revision	A.03.00

Method for Carrier (Backward Compatibility SCPI)

Mode	SA, WCDMA, WIMAX OFDMA, TD-SCDMA, DVB-T/H, DTMB (CTTB), ISDB-T, CMMB, LTE, LTETDD, Digital Cable TV, MSR
Remote Command	[:SENSe]:ACP:Power:CARRier[1] 2:LIST:METhod IBW RRC, ... [:SENSe]:ACP:Power:CARRier[1] 2:LIST:METhod?
Example	ACP:CARR2:LIST:METh RRC ACP:CARR2:LIST:METh?
Notes	You must be in the mode that includes ACP measurements to use this command. Use :INSTrument:SElect to set the mode. Maximum of Array length depends on the number of carriers.
Couplings	This command is an alias to [:SENSe]:ACP:Power:CARRier[1]2:LIST:FILTer[:RRC]:[STATe] The enum value translates as follows: RRC Weighted = 1 ON

	Integ BW = 0 OFF Maximum of Array length depends on the number of carriers.
Preset	SA: IBW WCDMA: RRC WIMAX OFDMA: IBW TD-SCDMA: RRC DVB-T/H: IBW DTMB (CTTB): RRC ISDB-T: IBW CMMB: IBW LTE, MSR: IBW LTETDD: IBW Digital Cable TV: RRC
State Saved	Saved in instrument state.
Initial S/W Revision	Prior to A.02.00
Modified at S/W Revision	A.03.00

9 ACP Measurement
Mode

Mode

See "[Mode](#)" on page 162

Mode Preset

Returns the active mode to a known state.

Mode Preset does the following for the currently active mode:

- Aborts the currently running measurement.
- Brings up the default menu for the mode, with no active function.
- Sets measurement Global settings to their preset values for the active mode only.
- Activates the default measurement.
- Brings up the default menu for the mode.
- Clears the input and output buffers.
- Sets Status Byte to 0.

Mode Preset does not:

- Cause a mode switch
- Affect mode persistent settings
- Affect system settings
- See "[How-To Preset](#)" on page 660 for more information.

Key Path	Front-panel key
Remote Command	:SYSTem:PRESet
Example	:SYST:PRES
Notes	*RST is preferred over :SYST:PRES for remote operation. *RST does a Mode Preset, as done by the :SYST:PRES command, and it sets the measurement mode to Single measurement rather than Continuous for optimal remote control throughput. Clears all pending OPC bits. The Status Byte is set to 0.
Couplings	A Mode Preset aborts the currently running measurement, activates the default measurement, and gets the mode to a consistent state with all of the default couplings set.
Backwards Compatibility Notes	In the X-Series, the legacy "Factory Preset" has been replaced with Mode Preset, which only presets the currently active mode, not the entire instrument. In the X-Series, the way to preset the entire instrument is by using System, Restore System Defaults All, which behaves essentially the same way as restore System Defaults does on ESA and PSA. There is also no "Preset Type" as there is on the PSA. There is a green Mode Preset front-panel key that does a Mode Preset and a white-with-green-letters User Preset front-panel key that does a User Preset. The old PRESet:TYPE command is ignored (without generating an error), and SYST:PRES without a parameter does a Mode Preset, which should cover most backward code compatibility issues. The settings and correction data under the Input/Output front-panel key (examples: Input Z Corr, Ext Amp Gain, etc.) are no longer part of any Mode, so they will not be preset by a Mode Preset. They are preset using Restore Input/Output Defaults, Restore System Defaults All. Note that because User Preset does a Recall State, and all of these settings are saved in State, they ARE recalled when using

	User Preset.
Initial S/W Revision	Prior to A.02.00

How-To Preset

The table below shows all possible presets, their corresponding SCPI commands and front-panel access (key paths). Instrument settings depend on the current measurement context. Some settings are local to the current measurement, some are global (common) across all the measurements in the current mode, and some are global to all the available modes. In a similar way, restoring the settings to their preset state can be done within the different contexts.

Auto Couple - is a measurement local key. It sets all Auto/Man parameter couplings in the measurement to Auto. Any Auto/Man selection that is local to other measurements in the mode will not be affected.

Meas Preset - is a measurement local key. Meas Preset resets all the variables local to the current measurement except the persistent ones.

Mode Preset - resets all the current mode's measurement local and measurement global variables except the persistent ones.

Restore Mode Defaults - resets ALL the Mode variables (and all the Meas global and Meas local variables), including the persistent ones.

Type Of Preset	SCPI Command	Front Panel Access
Auto Couple	:COUPle ALL	Auto Couple front-panel key
Meas Preset	:CONFigure:<Measurement>	Meas Setup Menu
Mode Preset	:SYSTem:PRESet	Mode Preset (green key)
Restore Mode Defaults	:INSTrument:DEFault	Mode Setup Menu
Restore All Mode Defaults	:SYSTem:DEFault MODes	System Menu; Restore System Default Menu
*RST	*RST	not possible (Mode Preset with Single)
Restore Input/Output Defaults	:SYSTem:DEFault INPUt	System Menu; Restore System Default Menu
Restore Power On Defaults	:SYSTem:DEFault PON	System Menu; Restore System Default Menu
Restore Alignment Defaults	:SYSTem:DEFault ALIGN	System Menu; Restore System Default Menu
Restore Miscellaneous Defaults	:SYSTem:DEFault MISC	System Menu; Restore System Default Menu
Restore All System Defaults	:SYSTem:DEFault [ALL] :SYSTem:PRESet:PERsistent	System Menu; Restore System Default Menu
User Preset	:SYSTem:PRESet:USER	User Preset Menu
User Preset All Modes	:SYSTem:PRESet:USER:ALL	User Preset Menu

Power On Mode Preset	:SYSTem:PON:TYPE MODE	System Menu
Power On User Preset	:SYSTem:PON:TYPE USER	System Menu
Power On Last State	:SYSTem:PON:TYPE LAST	System Menu

Mode Setup

See "[Mode Setup](#)" on page 181

Peak Search

Places the selected marker on the trace point with the maximum y-axis value.

Key Path	Peak Search
Mode	SA, WCDMA, C2K, WIMAX OFDMA, TD-SCDMA, 1xEVDO, DVB-T/H, DTMB (CTTB), ISDB-T, CMMB, LTE, LTE-TDD, Digital Cable TV, MSR, LTEAFDD, LTEATDD
Remote Command	:CALCulate:ACPower:MARKer [1] 2 . . . 12 :MAXimum
Example	CALC:ACP:MARK2:MAX
Initial S/W Revision	Prior to A.02.00
Modified at S/W Revision	A.02.00, A.03.00

Next Peak

Moves the selected marker to the peak that has the next highest amplitude.

Key Path	Peak Search
Mode	SA, WCDMA, C2K, WIMAX OFDMA, TD-SCDMA, 1xEVDO, DVB-T/H, DTMB (CTTB), ISDB-T, CMMB, LTE, LTE-TDD, Digital Cable TV, MSR, LTEAFDD, LTEATDD
Remote Command	:CALCulate:ACPower:MARKer [1] 2 . . . 12 :MAXimum:NEXT
Example	CALC:ACP:MARK2:MAX:NEXT
Initial S/W Revision	Prior to A.02.00
Modified at S/W Revision	A.02.00, A.03.00

Next Pk Right

Moves the selected marker to the nearest peak to the right of the current marker that meets all enabled peak criteria.

Key Path	Peak Search
Mode	SA, WCDMA, C2K, WIMAX OFDMA, TD-SCDMA, 1xEVDO, DVB-T/H, DTMB (CTTB), ISDB-T, CMMB, LTE, LTE-TDD, Digital Cable TV, MSR, LTEAFDD, LTEATDD
Remote Command	:CALCulate:ACPower:MARKer [1] 2 . . . 12 :MAXimum:RIGHT
Example	CALC:ACP:MARK2:MAX:RIGH
Initial S/W Revision	Prior to A.02.00
Modified at S/W Revision	A.02.00, A.03.00

Next Pk Left

Moves the selected marker to the nearest peak to the left of the current marker that meets all enabled peak criteria.

Key Path	Peak Search
Mode	SA, WCDMA, C2K, WIMAX OFDMA, TD-SCDMA, 1xEVDO, DVB-T/H, DTMB (CTTB), ISDB-T, CMMB, LTE, LTETDD, Digital Cable TV, MSR, LTEAFDD,LTEATDD
Remote Command	:CALCulate:ACPower:MARKer[1] 2 ... 12:MAXimum:LEFT
Example	CALC:ACP:MARK2:MAX:LEFT
Initial S/W Revision	Prior to A.02.00
Modified at S/W Revision	A.02.00, A.03.00

Marker Delta

Sets the control mode for the selected marker to Delta mode.

See Marker Delta in the "Marker Functions" section for more information.

Key Path	Peak Search
Initial S/W Revision	Prior to A.02.00

Pk-Pk Search

Finds and displays the amplitude and frequency (or time, if in zero span) differences between the highest and lowest y-axis value.

Key Path	Peak Search
Mode	SA, WCDMA, C2K, WIMAX OFDMA, TD-SCDMA, 1xEVDO, DVB-T/H, DTMB (CTTB), ISDB-T, CMMB, LTE, LTETDD, Digital Cable TV, MSR, LTEAFDD,LTEATDD
Remote Command	:CALCulate:ACPower:MARKer[1] 2 ... 12:PTPeak
Example	CALC:ACP:MARK:PTP
Notes	Turns on the Marker Δ active function.
Couplings	This key is not available (key is grayed out) when Coupled Markers is on.
Initial S/W Revision	Prior to A.02.00
Modified at S/W Revision	A.02.00, A.03.00

Min Search

Moves the selected marker to the minimum y-axis value on the current trace.

Key Path	Peak Search
Mode	SA, WCDMA, C2K, WIMAX OFDMA, TD-SCDMA, 1xEVDO, DVB-T/H, DTMB (CTTB), ISDB-T, CMMB, LTE, LTEFDD, Digital Cable TV, MSR, LTEAFDD, LTEATDD
Remote Command	:CALCulate:ACPower:MARKer [1] 2 . . . 12:MINimum
Example	CALC:ACP:MARK:MIN
Initial S/W Revision	Prior to A.02.00
Modified at S/W Revision	A.02.00, A.03.00

9 ACP Measurement
Print

Print

See "[Print](#) " on page 188

Quick Save

The Quick Save front-panel key repeats the most recent save that was performed from the Save menu, with the following exceptions:

- Register saves are not remembered as Saves for the purpose of the Quick Save function
- If the current measurement does not support the last non-register save that was performed, an informational message is generated, “File type not supported for this measurement”

Quick Save repeats the last type of qualified save (that is, a save qualified by the above criteria) in the last save directory by creating a unique filename using the Auto File Naming algorithm described below.

If Quick Save is pressed after startup and before any qualified Save has been performed, the Quick Save function performs a Screen Image save using the current settings for Screen Image saves (current theme, current directory), which then becomes the “last save” for the purpose of subsequent Quick Saves.

The Auto File Naming feature automatically generates a file name for use when saving a file. The filename consists of a prefix and suffix separated by a dot, as is standard for the Windows® file system. A default prefix exists for each of the available file types:

Type	Default Prefix	Menu
State	State_	(Save/Recall)
Trace + State	State_	(Save/Recall)
Screen	Screen_	(Save/Recall)
Amplitude Corrections	Ampcor_	(Import/Export)
Traces	Trace_	(Import/Export)
Limit Lines	LLine_	(Import/Export)
Measurement Result	MeasR_	(Import/Export)
Capture Buffer	CapBuf_	(Import/Export)

A four digit number is appended to the prefix to create a unique file name. The numbering sequence starts at 0000 within each Mode for each file type and updates incrementally to 9999, then wraps to 0000 again. It remembers where it was through a Mode Preset and when leaving and returning to the Mode. It is reset by Restore Misc Defaults and Restore System Defaults and subsequent running of the instrument application. So, for example, the first auto file name generated for State files is State_0000.state. The next is State_0001, and so forth.

One of the key features of Auto File Name is that we guarantee that the Auto File Name will never conflict with an existing file. The algorithm looks for the next available number. If it gets to 9999, then it looks for holes. If it find no holes, that is no more numbers are available, it gives an error.

For example, if when we get to State_0010.state there is already a State_0010.state file in the current directory, it advances the counter to State_0011.state to ensure that no conflict will exist (and then it verifies that State_0011.state also does not exist in the current directory and advances again if it does, and so forth).

If you enter a file name for a given file type, then the prefix becomes the filename you entered instead of the default prefix, followed by an underscore. The last four letters (the suffix) are the 4-digit number.

For example, if you save a measurement results file as “fred.csv”, then the next auto file name chosen for a measurement results save will be fred_0000.csv.

NOTE

Although 0000 is used in the example above, the number that is used is actually the current number in the Meas Results sequence, that is, the number that would have been used if you had not entered your own file name.

NOTE

If the filename you entered ends with _dddd, where d=any number, making it look just like an auto file name, then the next auto file name picks up where you left off with the suffix being dddd + 1.

Key Path	Front-panel key
Notes	No remote command for this key specifically.
Initial S/W Revision	Prior to A.02.00

Recall

The Recall menu lets you choose what you want to recall, and where you want to recall it from. Among the types of files you can recall are **States and Traces**. In addition, an Import (Data) option lets you recall a number of data types stored in CSV files (as used by Excel and other spreadsheet programs).

NOTE

In products that run multiple instances of the X-Series Application, all instances share the same register and file location where you want to recall from.

The default paths for Recall are data type dependent and are the same as for the Save key.

Key Path	Front-panel key
Notes	<p>No remote command for this key specifically, but the :MMEM:LOAD command is available for specific file types. An example is :MMEM:LOAD:STATE <filename>.</p> <p>If you try to recall a State file for a mode that is not licensed or not available in the instrument, an error message will occur and the state will not change.</p>
Backwards Compatibility Notes	<p>In legacy analyzers, it was possible to load a state without affecting the trace data, limit lines or correction data. Similarly (since User Preset is actually loading a state), it was possible to do a User Preset without affecting the trace data, limit lines or correction data.</p> <p>In the X-Series, “state” always includes all of this data; so whenever state is loaded, all of the traces, limit lines and corrections are affected. Although this differs from previous behavior, it is desirable behavior, and should not cause adverse issues for users.</p>
Backwards Compatibility Notes	<p>Recall for the X-Series supports backward compatibility in the sense that you can recall a state file from any X-Series model number and any version of X-Series software. This is only possible if part of the recalling process goes through a limiting step after recalling the mode settings, at least for settings that may vary with version number, model number, option and license differences. If you try to recall a state file onto an instrument with less capability than what was available on the instrument during the save, the recall will ignore the state it doesn't support and it will limit the recalled setting to what it allows.</p> <p>Example: if the saved state includes preamp ON, but the recalling instrument does not have a preamp; the preamp is limited to OFF. Conversely, if you save a state without a preamp, the preamp is OFF in the state file. When this saved file is recalled on an instrument with a licensed preamp, the preamp is changed to OFF. Another example is if the saved state has center frequency set to 20 GHz, but the instrument recalling the saved state is a different model and only supports 13.5 GHz. In this case, the center frequency is limited along with any other frequency based settings. Since the center frequency can't be preserved in this case, the recall limiting tries to at least preserve span to keep the measurement setup as intact as possible.</p> <p>It may be appropriate to issue a warning if the state is limited on the recall; warnings do not go out to SCPI so this would only affect the manual user.</p> <p>Note that there is no state file compatibility outside of the X-Series. For example, you cannot recall a state file from ESA or PSA.</p>
Initial S/W Revision	Prior to A.02.00

State

The Recall State menu lets you choose a register or file from which to recall the state.

The content of a state file includes all of the settings and data required to return the analyzer as closely as possible to the Mode it was in, with the exact settings that were in place, when the save occurred. The Mode settings in each state file include the settings that are affected by Mode Preset, as well as the additional settings affected by Restore Mode Defaults; all of the Mode's settings. In addition, all of the settings of the Input/Output system are included, even though they are outside of the Mode's state, because they are needed to restore the complete setup. Persistent System settings (for example, GPIB address) are not affected by either a Mode Preset or Restore Mode Defaults, nor are they included in a saved State file.

Since each state file is only for one Mode, the settings for other Modes are unaffected when it is loaded. Recall State will cause a mode switch if the state being recalled is not from the current active mode.

After the recall completes, the message "File <filename> recalled" or "Recalled State Register <register number>" is displayed.

For rapid recalls, the State menu lists 16 registers that you can choose from to recall. Pressing a Register key initiates the recall. You can also select a file from which to recall.

The default path for all State Files is:

My Documents\<mode name>\state

where <mode name> is the parameter used to select the mode with the INST:SEL command (for example, SA for the Spectrum Analyzer).

See ["More Information" on page 671](#).

Key Path	Recall
Mode	All
Remote Command	:MMEMory:LOAD:STATe <filename>
Example	:MMEM:LOAD:STAT "myState.state" This recalls the file myState.state on the default path
Example	MMEM:LOAD:STAT "MyStateFile.state" This loads the state file data (on the default file directory path) into the instrument state.
Notes	<p>When you pick a file to recall, the analyzer first verifies that the file is recallable in the current instrument by checking the software version and model number of the instrument. If everything matches, a full recall proceeds by aborting the currently running measurement, clearing any pending operations, and then loading the State from the saved state file. You can open state files from any mode, so recalling a State file switches to the mode that was active when the save occurred. After switching to the mode of the saved state file, mode settings and data (if any for the mode) are loaded with values from the saved file. The saved measurement of the mode becomes the newly active measurement and the data relevant to the measurement (if there is any) is recalled.</p> <ul style="list-style-type: none"> • If there is a mismatch between file version or model number or instrument version or model number, the recall function tries to recall as much as possible and returns a warning message. It may limit settings that differ based on model number, licensing or version number. <p>After recalling the state, the Recall State function does the following:</p> <ul style="list-style-type: none"> • Makes the saved measurement for the mode the active measurement. • Clears the input and output buffers. • Status Byte is set to 0.

	<ul style="list-style-type: none"> • Executes a *CLS <p>If the file specified is empty an error is generated. If the specified file does not exist, another error is generated. If there is a mismatch between the file and the proper file type, an error is generated. If there is a mismatch between file version or model number or instrument version or model number, a warning is displayed. Then it returns to the State menu and File Open dialog goes away.</p> <p>After the Recall, the analyzer exits the Recall menu and returns to the previous menu.</p>
Backwards Compatibility SCPI	:MMEMory:LOAD:STATe 1,<filename>
Initial S/W Revision	Prior to A.02.00

More Information

In measurements that support saving Traces, for example, Swept SA, the Trace data is saved along with the State in the State file. When recalling the State, the Trace data is recalled as well. Traces are recalled exactly as they were stored, including the writing mode and update and display modes. If a Trace was updating and visible when the State was saved, it will come back updating and visible, and its data will be rewritten right away. When you use State to save and recall traces, any trace whose data must be preserved should be placed in View or Blank mode before saving.

The following table describes the Trace Save and Recall possibilities:

You want to recall state and one trace's data, leaving other traces unaffected.	Save Trace+State from 1 trace. Make sure that no other traces are updating (they should all be in View or Blank mode) when the save is performed.	On Recall, specify the trace you want to load the one trace's data into. This trace will load in View. All other traces' data will be unaffected, although their trace mode will be as it was when the state save was performed.
You want to recall all traces	Save Trace+State from ALL traces.	On Recall, all traces will come back in View (or Blank if they were in Blank or Background when saved)
You want all traces to load exactly as they were when saved.	Save State	On recall, all traces' mode and data will be exactly as they were when saved. Any traces that were updating will have their data immediately overwritten.

From File...

When you press "From File", the analyzer brings up a Windows dialog and a menu entitled "File Open." This menu allows you to navigate to the various fields in the Windows dialog without using a keyboard or mouse. The Tab and Arrow keys can also be used for dialog navigation.

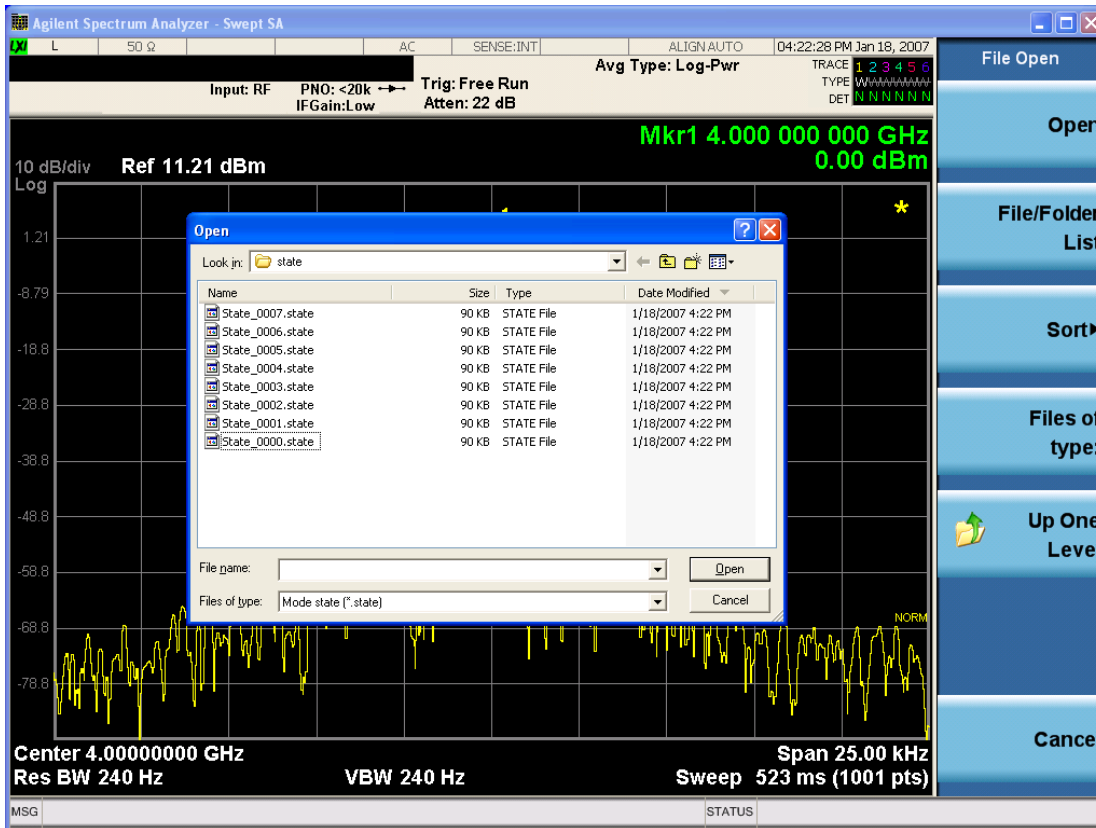

Listed below are the functions of the various fields in the dialog, and the corresponding softkeys:

Open

Performs the recall of the specified file. While the recall is being performed, the floppy icon appears briefly in the Meas bar.

File/Folder List

Enables you to navigate to the center of the dialog that contains the list of files and folders. Once here you can get information about the file and use the tab keys to navigate to the other fields in the dialog, such as Look In.

Look In

The Look In field shows the path from which the file will be recalled and allows you to change the path using the up and down arrow keys to navigate to other paths; the Enter key to open a directory; and the Backspace key to go back one directory. The **Look In field** first uses the last path from the Save As dialog **Save In:** path for that same file type. There is no softkey for directly navigating to the Look In field, but you can use the left tab to get here from the File/Folder List.

User specified paths are remembered when you leave and return to a Mode and are reset back to the default using Restore Mode Defaults.

Sort

Accesses a menu that enables you to sort the files within the File Open dialog. Only one sorting type can be selected at a time and the sorting happens immediately. The sorting types are By Date, By Name, By extension, and By Size.

Files of Type

This field shows the file suffix for the type of file you have selected to recall. For example, if you navigated here while recalling State, "Mode state (*.state)" is in the field. If you navigated here while recalling Trace, ""Mode state (*.trace)" is in the field. If you navigated here while importing a trace data file, "Trace Data (*.csv)" is in the field. For some file types, there is more than one choice in the dropdown menu, which you can select by using the up and down arrow keys and Enter.

Up One Level

This key corresponds to the icon of a folder with the up arrow that is in the tool bar of the dialog. When pressed, it causes the file and folder list to navigate up one level in the directory structure. The Backspace key does the same thing.

Cancel

This key corresponds to the Cancel selection in the dialog. It causes the current **Open** request to be cancelled. The ESC key does the same thing.

Key Path	Recall, State
Notes	Brings up the Open dialog for recalling a State Save Type
Initial S/W Revision	Prior to A.02.00

Edit Register Names

You may enter a custom name on any of the Register keys, to help you remember what you are using that state to save. To do this, press the Edit Register Names key, choose the register whose name you wish to edit, and then enter the desired label using the Alpha Editor or an external PC keyboard.

The maximum number of characters that can be added is 30. In most cases, 30 characters will fit on two lines of the key.

For more information and the SCPI command, see Edit Register Names under the Save, State function.

Key Path	Recall, State
Mode	All
Dependencies	N9060A-7FP or N9060B-2FP license required to edit the register names. When the feature is not licensed, sending the SCPI command generates an error, -221, "Settings conflict;Option not available"
Initial S/W Revision	A.11.00

Register 1 thru Register 16

Selecting any one of these register keys causes the State of the mode from the specified Register to be recalled. Each of the register keys annotates whether it is empty or at what date and time it was last

modified. In addition, you can use the Edit Register Names key under Save, State to enter custom names for each register.

NOTE In products that run multiple instances of the X-Series Application, recalling the same register name on each instance is a way to share setups between the instances.

Registers are shared by all modes, so recalling from any one of the registers will cause a mode switch to the mode that was active when the save to the Register occurred.

Although these 16 registers are the only registers available from the front panel, there are 128 state registers available in the instrument. Registers 17–128 are only available from the SCPI interface, using the *RCL command.

After the recall completes, the message "Register <register number> recalled" appears in the message bar. If you are in the Spectrum Analyzer Mode, and you are recalling a register that was saved in the Spectrum Analyzer Mode, then after the recall, you will still be in the Recall Register menu. If the Recall causes you to switch modes, then after the Recall, you will be in the Frequency menu.

If a requested register is empty an error is generated.

Key Path	Recall, State
Example	*RCL 1
Range	1–16 from front panel, 1–128 from SCPI
Readback	Date and time with seconds resolution are displayed on the key OR A custom name of up to 30 characters entered using the Save, State, Edit Register Names key OR “(empty)” if no prior save operation has been performed to this register.
Initial S/W Revision	Prior to A.02.00
Modified at S/W Revision	Prior to A.11.00

Register 1 thru Register 16

Selecting any one of these register keys causes the State of the mode from the specified Register to be recalled. Each of the register keys annotates whether it is empty or at what date and time it was last modified. In addition, you can use the Edit Register Names key under Save, State to enter custom names for each register.

NOTE In products that run multiple instances of the X-Series Application, recalling the same register name on each instance is a way to share setups between the instances.

Registers are shared by all modes, so recalling from any one of the registers will cause a mode switch to the mode that was active when the save to the Register occurred.

Although these 16 registers are the only registers available from the front panel, there are 128 state registers available in the instrument. Registers 17–128 are only available from the SCPI interface, using the *RCL command.

After the recall completes, the message "Register <register number> recalled" appears in the message bar. If you are in the Spectrum Analyzer Mode, and you are recalling a register that was saved in the Spectrum Analyzer Mode, then after the recall, you will still be in the Recall Register menu. If the Recall causes you to switch modes, then after the Recall, you will be in the Frequency menu.

If a requested register is empty an error is generated.

Key Path	Recall, State
Example	*RCL 1
Range	1-16 from front panel, 1-128 from SCPI
Readback	Date and time with seconds resolution are displayed on the key OR A custom name of up to 30 characters entered using the Save, State, Edit Register Names key OR “(empty)” if no prior save operation has been performed to this register.
Initial S/W Revision	Prior to A.02.00
Modified at S/W Revision	Prior to A.11.00

Sequences

These keys allow you to import a Tab separated or .txt file that will automatically setup all the parameters required for building a Sequence. The parameters will automatically be loaded into the Stated Sequencer.

Once selected, in order to import the selected Sequence Type you must select the Open key in the Source Sequence menu.

Key Path	Recall, Sequences
Mode	All
Remote Command	:MMEMory:LOAD:SEQuences: SLIS ALIS SAALIS "MySequence.txt"
Example	:MMEM:LOAD:SEQ:SLIS "MySequence.txt"
Notes	Available file types are: –CSV (Comma delimited) (*.csv) –Text (Tab delimited) (*.txt)
Initial S/W Revision	A.05.00

Source Sequence

The list of parameters, that configure steps, that makes up a sequence for the Source.

The Source sequence is a sequence of flexible configurable steps that can be set anywhere in the instruments frequency range.

Key Path	Recall, Sequences
----------	-------------------

Example	:MMEM:LOAD:SEQ:SLIS "MySequence.txt"
Dependencies	Only available in XOBT
Initial S/W Revision	A.05.00

Open...

When you press "Open", the analyzer brings up a Windows dialog and a menu entitled "File Open." This menu allows you to navigate to the various fields in the Windows dialog without using a keyboard or mouse. The Tab and Arrow keys can also be used for dialog navigation.

See "From File..." on page 2060 in Recall, State, for a full description of this dialog and menu.

Key Path	Recall, Data
Notes	The key location is mode-dependent and will vary. Brings up Open dialog for recalling a <mode specific> Save Type
Initial S/W Revision	Prior to A.02.00

Data (Import)

Importing a data file loads data that was previously saved from the current measurement or from other measurements and/or modes that produce compatible data files. The Import Menu only contains Data Types that are supported by the current measurement.

Since the commonly exported data files are in .csv format, the data can be edited by the user prior to importing. This allows you to export a data file, manipulate the data in Excel (the most common PC Application for manipulating .csv files) and then import it.

Importing Data loads measurement data from the specified file into the specified or default destination, depending on the data type selected. Selecting an Import Data menu key will not actually cause the importing to occur, since the analyzer still needs to know from where to get the data. Pressing the Open key in this menu brings up the Open dialog and Open menu that provides you with the options from where to recall the data. Once a filename has been selected or entered in the Open menu, the recall occurs as soon as the Open button is pressed.

Key Path	Recall
Mode	All
Notes	The menu is built from whatever data types are available for the mode. Some keys will be missing completely, so the key locations in the sub-menu will vary. No SCPI command directly controls the Data Type that this key controls. The Data Type is included in the MMEM:LOAD commands.
Dependencies	If a file type is not used by a certain measurement, it is grayed out for that measurement. The key for a file type will not show at all if there are no measurements in the Mode that support it.
Preset	Is not affected by Preset or shutdown, but is reset during Restore Mode Defaults

Readback	The data type that is currently selected
Initial S/W Revision	Prior to A.02.00

Capture Buffer

Capture buffer functionality is available only in Code Domain and Modulation Accuracy measurements. The captured data is raw data which is not processed.

Key Path	Recall, Data
Mode	CDMA2000
Example	MMEM:LOAD:CAPT "MyCaptureData.bin" This loads the file of capture data (on the default file directory path) into the instrument.
Dependencies	Capture buffer data is only available for Code Domain and Modulation Accuracy measurement. In other measurements, this key is grayed out.

Open...

When you press "Open", the analyzer brings up a Windows dialog and a menu entitled "File Open." This menu allows you to navigate to the various fields in the Windows dialog without using a keyboard or mouse. The Tab and Arrow keys can also be used for dialog navigation.

See "[From File...](#)" on page 2060 in Recall, State, for a full description of this dialog and menu.

Key Path	Recall, Data
Notes	The key location is mode-dependent and will vary. Brings up Open dialog for recalling a <mode specific> Save Type
Initial S/W Revision	Prior to A.02.00

Restart

The Restart function restarts the current sweep, or measurement, or set of averaged/held sweeps or measurements. If you are Paused, pressing Restart does a Resume.

The Restart function is accessed in several ways:

- Pressing the Restart key
- Sending the remote command INIT:IMMEDIATE
- Sending the remote command INIT:RESTART

See "[More Information](#)" on page 678

Key Path	Front-panel key
Remote Command	:INITiate[:IMMEDIATE] :INITiate:RESTART
Example	:INIT:IMM :INIT:REST
Notes	:INITiate:RESTART and :INITiate:IMMEDIATE perform exactly the same function.
Couplings	Resets average/hold count k. For the first sweep overwrites all active (update=on) traces with new current data. For application modes, it resets other parameters as required by the measurement.
Status Bits/OPC dependencies	This is an Overlapped command. The STATus:OPERation register bits 0 through 8 are cleared. The STATus:QUESTionable register bit 9 (INTEgrity sum) is cleared. The SWEEPING bit is set. The MEASURING bit is set.
Backwards Compatibility Notes	For Spectrum Analysis mode in ESA and PSA, the Restart hardkey and the INITiate:RESTART command restart trace averages (displayed average count reset to 1) for a trace in Clear Write, but did not restart Max Hold and Min Hold. In the X-Series, the Restart hardkey and the INITiate:RESTART command restart not only Trace Average, but MaxHold and MinHold traces as well. For wireless comms modes in ESA and PSA, the Restart hardkey and the INITiate:RESTART command restart every measurement, which includes all traces and numeric results. There is no change to this operation.
Initial S/W Revision	Prior to A.02.00

More Information

The **Restart** function first aborts the current sweep/measurement as quickly as possible. It then resets the sweep and trigger systems, sets up the measurement and initiates a new data measurement sequence with a new data acquisition (sweep) taken once the trigger condition is met.

If the analyzer is in the process of aligning when **Restart** is executed, the alignment finishes before the restart function is performed.

Even when set for Single operation, multiple sweeps may be taken when Restart is pressed (for example, when averaging/holding is on). Thus when we say that **Restart** "restarts a measurement," we may mean:

- It restarts the current sweep
- It restarts the current measurement
- It restarts the current set of sweeps if any trace is in Trace Average, Max Hold or Min Hold
- It restarts the current set of measurements if Averaging, or Max Hold, or Min Hold is on for the measurement
- depending on the current settings.

With **Average/Hold Number** (in **Meas Setup** menu) set to 1, or Averaging off, or no trace in Trace Average or Hold, a single sweep is equivalent to a single measurement. A single sweep is taken after the trigger condition is met; and the analyzer stops sweeping once that sweep has completed. However, with **Average/Hold Number** >1 and at least one trace set to **Trace Average, Max Hold, or Min Hold (SA Measurement)** or **Averaging on (most other measurements)**, multiple sweeps/data acquisitions are taken for a single measurement. The trigger condition must be met prior to each sweep. The sweep is stopped when the average count k equals the number N set for **Average/Hold Number**. A measurement average usually applies to all traces, marker results, and numeric results; but sometimes it only applies to the numeric results.

Once the full set of sweeps has been taken, the analyzer will go to idle state. To take one more sweep without resetting the average count, increment the average count by 1, by pressing the step up key while **Average/Hold Number** is the active function, or sending the remote command `CALC:AVER:TCON UP`.

Save

The Save menu lets you choose what you want to save and where you want to save it. Among the types of files you can save are **States**, **Traces**, and **Screen Images**. In addition, an Export (Data) option lets you save a number of data types as CSV files for easy import into Excel and other spreadsheet programs.

Key Path	Front-panel key
Mode	All
Notes	No remote command for this key specifically, but the :MMEM:STORe command is available for specific file types. An example is :MMEM:STOR:STATe <filename>.
Initial S/W Revision	Prior to A.02.00

State

The Save State menu lets you choose a register or file for saving the state.

NOTE

In products that run multiple instances of the X-Series Application, all instances share the same register and file location where you want to save the state.

The content of a state file includes all of the settings and data required to return the analyzer as closely as possible to the Mode it was in, with the exact settings which were in place, when the save occurred. The Mode settings in each state file include the settings that are affected by Mode Preset, as well as the additional settings affected by Restore Mode Defaults; all of the Mode's settings. In addition, all of the settings of the Input/Output system are included, even though they are outside of the Mode's state, because they are needed to restore the complete setup. Persistent System settings (for example, Verbose SCPI) are not affected by either Mode Preset or Restore Mode Defaults, nor are they included in a saved State file.

After the save completes, the message "File <filename> saved" or "State Register <register number> saved" is displayed.

For rapid saving, the State menu lists 16 registers to save to. Pressing a Register key initiates the save. You can also select a file to save to.

The default path for all State Files is:

My Documents\<<mode name>\state

where <mode name> is the parameter used to select the mode with the INST:SEL command (for example, SA for the Spectrum Analyzer).

Key Path	Save
Mode	All
Remote Command	:MMEMory:STORe:STATe <filename>
Example	MMEM:STOR:STATe "MyStateFile.state" This stores the current instrument state data in the file MyStateFile.state in the default directory.
Notes	Both single and double quotes are supported for any filename parameter over remote.

After saving to a register, that register's menu key is updated with the date the time, unless a custom label has been entered for that key.

After saving to a register, you remain in the Save State menu, so that you can see the Register key update. After saving to a file, the analyzer automatically returns to the previous menu and any Save As dialog goes away.

Backwards Compatibility SCPI :MMEMory:STORe:STATe 1,<filename>

For backwards compatibility, the above syntax is supported. The "1" is simply ignored. The command is sequential.

Initial S/W Revision Prior to A.02.00

To File . . .

When you press "To File", the analyzer brings up a Windows dialog and a menu entitled "Save As." This menu allows you to navigate to the various fields in the Windows dialog without using a keyboard or mouse. The Tab and Arrow keys can also be used for dialog navigation.

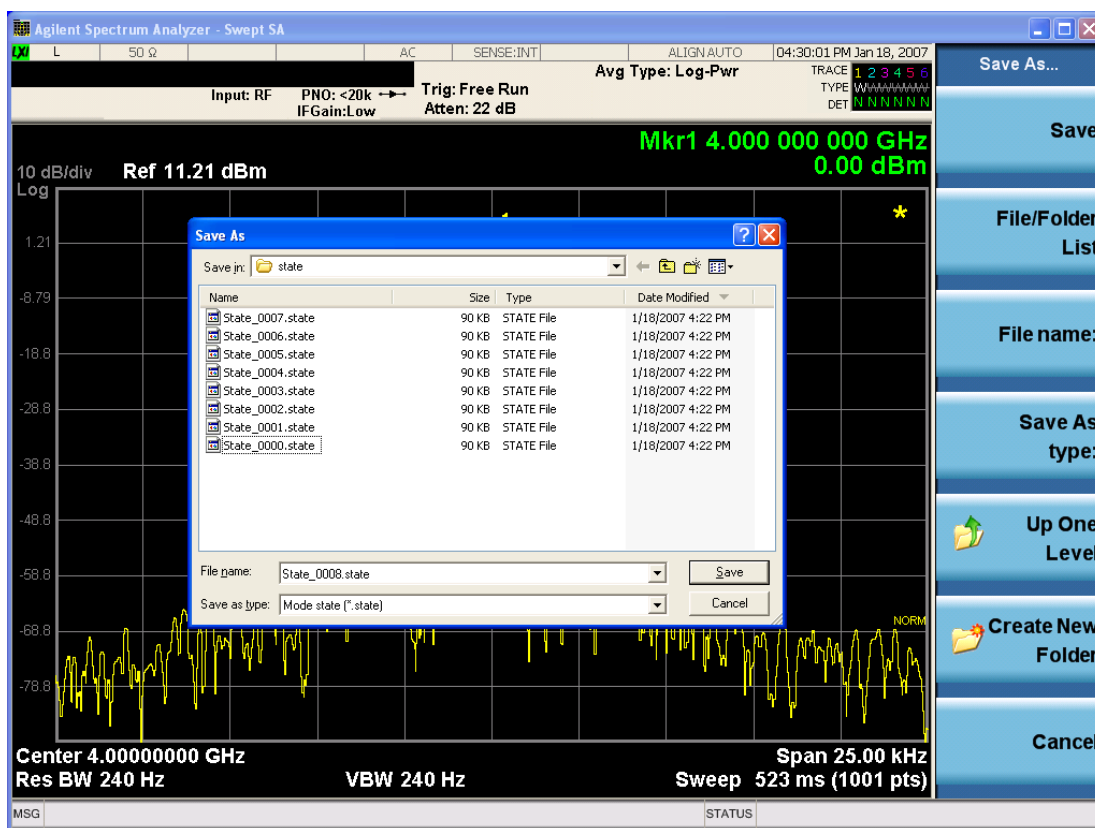

The Listed below

are the functions of the various fields in the dialog, and the corresponding softkeys:

Save

Performs the save to the specified file of the selected type. If the file already exists, a dialog will appear that allows you to replace the existing file by selecting OK, or you can Cancel the request. If you select OK,

the file will be overwritten. Using the C: drive is strongly discouraged, since it runs the risk of being overwritten during an instrument software upgrade.

While the save is being performed, the floppy icon appears briefly in the Meas bar.

File/Folder List

Enables you to navigate to the center of the dialog that contains the list of files and folders. Once here you can get information about the file and use the tab keys to navigate to the other fields in the dialog, such as Save In.

Save In

The Save In field shows the path to which the file will be saved and allows you to change the path using the up and down arrow keys to navigate to other paths; the Enter key to open a directory; and the Backspace key to go back one directory. The **Save In field** defaults to the default path for this type of file and remembers the last path you used to save this type of file. There is no softkey for directly navigating to the Save In field but you can use left tab to get here from the File/Folder List.

User specified paths are remembered when you leave and return to a Mode and are reset back to the default using Restore Mode Defaults.

File Name

The File Name field is initially loaded with an automatically generated filename specific to the appropriate Save Type. The automatically generated filename is guaranteed not to conflict with any filename currently in the directory. You may replace or modify this filename using the File Name key. See the ["Quick Save " on page 2056](#) documentation for more on the automatic file naming algorithm.

When you press the File Name key the analyzer displays the Alpha Editor. Use the knob to choose the letter to add and the front-panel Enter key to add the letter to the file name. The BK character moves you back and the FW character moves you forward in the filename. The Select key on the front panel generates a space character. When you are done entering the filename press the Done softkey. This returns back to the **File Open** dialog and menu, but does not cause the save to occur.

Save As Type

This field shows the file suffix for the type of file you have selected to save. For example, if you navigated here while saving State, "Mode state (*.state)" is in the field. If you navigated here from saving Trace, ""Mode state (*.trace)" is in the field. If you navigated here while exporting a trace data file, "Trace Data (*.csv)" is in the field. For some file types, there is more than one choice in the dropdown, which you can select by using the up and down arrow keys and Enter.

Up One Level

This key corresponds to the icon of a folder with the up arrow that is in the tool bar of the dialog. When pressed, it causes the file and folder list to navigate up one level in the directory structure. The Backspace key does the same thing.

Create New Folder

This key corresponds to the icon of a folder with the "*" that is in the tool bar of the dialog. When pressed, a new folder is created in the current directory with the name **New Folder** and you can enter a new folder name using the Alpha Editor.

Cancel

This key corresponds to the Cancel selection in the dialog. It causes the current **Save As** request to be cancelled. The ESC key does the same thing.

Key Path	Save, State
Mode	All
Notes	Brings up Save As dialog for saving a State Save Type
Initial S/W Revision	Prior to A.02.00

Edit Register Names

You may enter a custom name on any of the Register keys, to help you remember what you are using that state to save. To do this, press the Edit Register Names key, choose the register whose name you wish to edit, and then enter the desired label using the Alpha Editor or an external PC keyboard.

The maximum number of characters that can be added is 30. In most cases, 30 characters will fit on two lines of the key.

See "[More Information](#)" on page 683

Key Path	Save, State
Mode	All
Remote Command	:MMEMory:REGister:STATe:LABel <reg number>,"label" :MMEMory:REGister:STATe:LABel? <reg number>
Example	:MMEM:REG:STAT:LAB 1,"my label"
Notes	<reg number> is an integer from 1 to 16. If the SCPI specifies an invalid register number an error message is generated, -222,"Data out of range;Invalid register label number" "label" is a string from 0 to 30 characters in length. If a label exceeds 30 characters, an error message is generated, -150,"String data error;Label clipped to 30 characters" "label" of length 0 erases the custom label and restores the default (time and date) label. E.g.: :MMEM:REG:STAT:LAB 1,""
Dependencies	N9060A-7FP or N9060B-2FP license required to edit the register names. When the feature is not licensed, sending this command generates an error, -221,"Settings conflict;Option not available"
Preset	The names are unaffected by Preset or power cycle but are set to the default label (time and date) on a "Restore System Defaults->Misc"
Initial S/W Revision	A.11.00

More Information

When you edit one of the register names, the time and date field will be replaced by the custom name.

If you delete all the characters in the custom name, it restores the default (time and date).

The register names are stored within the state files, but they are not part of the instrument state; that is, once you have edited a register name, loading a new state will not change that register name. Another

consequence of this is that the names will be persistent through a power cycle. Also, if a named state file is transferred to another analyzer, it will bring its custom name along with it.

If you try to edit the name of an empty register, the analyzer will first save the state to have a file to put the name in. If you load a named state file into an analyzer with older firmware it will ignore the metadata.

The *SAV and *RCL commands will not be affected by the custom register names, nor will the MMEM commands.

Register 1 thru Register 16

Selecting any one of these register menu keys causes the State of the currently active mode to be saved to the specified Register. The registers are provided for rapid saving and recalling, since you do not need to specify a filename or navigate to a file. Each of the register menu keys annotates whether it is empty or at what date and time it was last modified. In addition, you can use the Edit Register Names key to enter custom names for each register.

NOTE

In products that run multiple instances of the X-Series Application, save with different register name if you do not want to overwrite the register of another running instance.

Although these 16 registers are the only registers available from the front panel, there are 128 state registers available in the instrument. Registers 17–128 are only available from the SCPI interface, using the *SAV command.

There is one set of 128 state registers in the instrument, not one set for each Mode. When a state is saved, the Mode it was saved from is saved with it; then when it is recalled, the instrument switches to that Mode.

After the save completes, the corresponding register menu key annotation is updated with the date and time and the message "Register <register number> saved" is displayed.

Key Path	Save, State
Mode	All
Example	*SAV 1
Range	1–16 from front panel, 1–128 from SCPI
Readback	Date and time with seconds resolution are displayed on the key OR A custom name of up to 30 characters entered using the Edit Register Names key OR “(empty)” if no prior save operation has been performed to this register.
Initial S/W Revision	Prior to A.02.00
Modified at S/W Revision	A.11.00

Register 1 thru Register 16

Selecting any one of these register menu keys causes the State of the currently active mode to be saved to the specified Register. The registers are provided for rapid saving and recalling, since you do not need to specify a filename or navigate to a file. Each of the register menu keys annotates whether it is empty or at

what date and time it was last modified. In addition, you can use the Edit Register Names key to enter custom names for each register.

NOTE

In products that run multiple instances of the X-Series Application, save with different register name if you do not want to overwrite the register of another running instance.

Although these 16 registers are the only registers available from the front panel, there are 128 state registers available in the instrument. Registers 17–128 are only available from the SCPI interface, using the *SAV command.

There is one set of 128 state registers in the instrument, not one set for each Mode. When a state is saved, the Mode it was saved from is saved with it; then when it is recalled, the instrument switches to that Mode.

After the save completes, the corresponding register menu key annotation is updated with the date and time and the message "Register <register number> saved" is displayed.

Key Path	Save, State
Mode	All
Example	*SAV 1
Range	1–16 from front panel, 1–128 from SCPI
Readback	Date and time with seconds resolution are displayed on the key OR A custom name of up to 30 characters entered using the Edit Register Names key OR “(empty)” if no prior save operation has been performed to this register.
Initial S/W Revision	Prior to A.02.00
Modified at S/W Revision	A.11.00

Mass Storage Catalog (Remote Command Only)

Key path	SCPI Only
Remote Command	:MMEMory:CATalog? [<directory_name>]
Notes	The string must be a valid logical path. Queries disk usage information (drive capacity, free space available) and obtains a list of files and directories in a specified directory in the following format: <numeric_value>,<numeric_value>,{<file_entry>} It returns two numeric parameters and as many strings as there are files and directories. The first parameter indicates the total amount of storage currently used in bytes. The second parameter indicates the total amount of storage available, also in bytes. The <file_entry> is a string. Each <file_entry> indicates the name, type, and size of one file in the directory list: <file_name>,<file_type>,<file_size> As the windows file system has an extension that indicates file type, <file_type> is always empty. <file_size> provides the size of the file in bytes. For directories, <file_entry> is surrounded by square brackets and both <file_type> and <file_size> are empty
Initial S/W Revision	Prior to A.02.00

Mass Storage Change Directory (Remote Command Only)

Key path	SCPI Only
Remote Command	:MMEMory:CDIRectory [<directory_name>] :MMEMory:CDIRectory?
Notes	The string must be a valid logical path. Changes the default directory for a mass memory file system. The <directory_name> parameter is a string. If no parameter is specified, the directory is set to the *RST value. At *RST, this value is set to the default user data storage area, that is defined as System.Environment.SpecialFolder.Personal. Query returns full path of the default directory.
Initial S/W Revision	Prior to A.02.00

Mass Storage Copy (Remote Command Only)

Key path	SCPI Only
Remote Command	:MMEMory:COPY <string>,<string>[,<string>,<string>]
Notes	The string must be a valid logical path. Copies an existing file to a new file or an existing directory to a new directory. Two forms of parameters are allowed. The first form has two parameters. In this form, the first parameter specifies the source, and the second parameter specifies the destination. The second form has four parameters. In this form, the first and third parameters specify the source. The second and fourth parameters specify the directories. The first pair of parameters specifies the source. The second pair specifies the destination. An error is generated if the source doesn't exist or the destination file already exists. This command will generate an "access denied" error if the destination is a restricted folder (e.g., C:\Windows) and the current user does not have Power User or Administrator privileges.

Mass Storage Device Copy (Remote Command Only)

This command transfers data to/from a file and a peripheral device.

Key path	SCPI Only
Remote Command	:MMEMory:COPY:DEvice <source_string>,<dest_string>
Notes	The strings must be a valid logical path or a valid device keyword. If the dest_string is a device keyword, the data is copied from the source file to the device. If the source_string is a device keyword, the data is copied to the source file from the device. Valid device keywords are: SNS (smart noise source) An error is generated if the file or device is not found.

Mass Storage Delete (Remote Command Only)

Key path	SCPI Only
Remote Command	:MMEMory:DELeTe <file_name>[,<directory_name>]
Notes	The string must be a valid logical path. Removes a file from the specified directory. The <file_name> parameter specifies the file name to be removed. This command will generate an “access denied” error if the file is in a restricted folder (e.g., C:\Windows) and the current user does not have Power User or Administrator privileges.
Initial S/W Revision	Prior to A.02.00

Mass Storage Data (Remote Command Only)

Creates a file containing the specified data OR queries the data from an existing file.

Key path	SCPI Only
Remote Command	:MMEMory:DATA <file_name>, <data> :MMEMory:DATA? <file_name>
Notes	The string must be a valid logical path. The command form is MMEMory:DATA <file_name>,<data>. It loads <data> into the file <file_name>. <data> is in 488.2 block format. <file_name> is string data. The query form is MMEMory:DATA? <file_name> with the response being the associated <data> in block format.
Initial S/W Revision	Prior to A.02.00

Mass Storage Make Directory (Remote Command Only)

Key path	SCPI Only
Remote Command	:MMEMory:MDIRectory <directory_name>
Notes	The string must be a valid logical path. Creates a new directory. The <directory_name> parameter specifies the name to be created. This command will generate an “access denied” error if the new directory would be in a restricted folder (e.g., C:\Windows) and the current user does not have Power User or Administrator privileges.
Initial S/W Revision	Prior to A.02.00

Mass Storage Move (Remote Command Only)

Key path	SCPI Only
Remote Command	:MMEMory:MOVE <string>,<string>[,<string>,<string>]
Notes	The string must be a valid logical path. Moves an existing file to a new file or an existing directory to a new directory.

Two forms of parameters are allowed. The first form has two parameters. In this form, the first parameter specifies the source, and the second parameter specifies the destination.

The second form has four parameters. In this form, the first and third parameters specify the source. The second and fourth parameters specify the directories. The first pair of parameters specifies the source. The second pair specifies the destination. An error is generated if the source doesn't exist or the destination file already exists.

This command will generate an "access denied" error if the destination is a restricted folder (e.g., C:\Windows) and the current user does not have Power User or Administrator privileges.

Initial S/W Revision Prior to A.02.00

Mass Storage Remove Directory (Remote Command Only)

Key path SCPI Only

Remote Command :MMEMory:RDIRECTory <directory_name>

Notes

The string must be a valid logical path.

Removes a directory. The <directory_name> parameter specifies the directory name to be removed. All files and directories under the specified directory shall also be removed.

This command will generate an "access denied" error if the folder is a restricted folder (e.g., C:\Windows) or is in a restricted folder and the current user does not have Power User or Administrator privileges.

Initial S/W Revision Prior to A.02.00

Mass Storage Determine Removable Media (Remote Command Only)

This command is used to determine if any removable media devices are connected to the instrument. Primarily, these are USB memory devices plugged-in to the front panel or rear panel USB ports. On instruments with PC6 or PC7 CPU's, one SD card slot is available for removable media. The instrument's primary disk drive is not a removable media device.

Key Path SCPI Only

Remote Command :MMEMory:RMEDIA:LIST?

Notes

The return value will be a string containing a list of partition identifiers which are removable media devices. Each identifier will be separated by a comma. If no removable media is present, an empty string will be returned.

Examples:

One removable device present will result in a return string of "F:".

Two removable devices present will result in a return string of "F:,G:".

No removable devices present will result in a return string of "".

Initial S/W Revision x.15.00

Mass Storage Determine Removable Media Label (Remote Command Only)

This command is used to set or query a removable media device's label.

Key Path	SCPI Only
Remote Command	:MMEMory:RMEDia:LABel <partition>,<string> :MMEMory:RMEDia:LABel? <partition>
Example	MMEM:RMED:LAB "F:","My Device"
Notes	If the <partition> specified does not exist or is not a removable media device the error -252,"Missing Media" will be generated. Setting the removable media label requires Administrative privileges. If the currently logged in user does not have appropriate privileges the error "-221.9900,Settings conflict;Administrator privileges required" is generated.
Initial S/W Revision	x.15.00

Mass Storage Determine Removable Media Write-protect status (Remote Command Only)

This command is used to query a removable media device's write-protect status.

Key Path	SCPI Only
Remote Command	:MMEMory:RMEDia:WPRotect? <partition>
Example	MMEM:RMED:WPR? "F:"
Notes	The return value is 1 if the device is write-protected, and 0 if the device is write-enabled. If the <partition> specified does not exist or is not a removable media device the error -252,"Missing Media" will be generated.
Preset	The return value will be depending on SD card installed.
Initial S/W Revision	x.15.00

Mass Storage Determine Removable Media size (Remote Command Only)

This command is used to query a removable media device's total memory size (not available memory size).

Key Path	SCPI Only
Remote Command	:MMEMory:RMEDia:SIZE? <partition>
Example	MMEM:RMED:SIZE? "F:"
Notes	The return value is integer value in GBytes. Any device which is less than 1 GB will return 0 GB. If the <partition> specified does not exist or is not a removable media device the error -252,"Missing Media" will be generated.
Initial S/W Revision	x.15.00

Sequences

These keys allow you to save a Tab separated or CSV file of the setup parameters required to build a Sequence.

In order to save you must select the Save As button and choose a destination folder.

Key Path	Save, Sequences
Mode	All
Remote Command	:MMEM:STOR:SEQ:ences: SLIST ALIST SAAList SStep "MySequence.txt"
Example	:MMEM:STOR:SEQ:SLIST "MySequence.txt"
Notes	Available file types are: –CSV (Comma delimited) (*.csv) –Text (Tab delimited) (*.txt)
Initial S/W Revision	A.05.00

Source Sequence

The list of parameters, that configure steps, that makes up a sequence for the Source.

The Source sequence is a sequence of flexible configurable steps that can be set anywhere in the instruments frequency range.

Key Path	Save, Sequences
Example	:MMEM:STOR:SEQ:SLIS "MySequence.txt"
Dependencies	Only available in XOBT
Initial S/W Revision	A.05.00

Save As . . .

This menu lets you select the location where you can save the Sequence. This menu is a standard Windows® dialog with Save As menu keys. The "File Name" field in the Save As dialog is initially loaded with an automatically generated filename specific to the appropriate Save Type. The automatically generated filename is guaranteed not to conflict with any filename currently in the directory. You may replace or modify this filename using the File Name softkey. See the Quick Save key documentation for more on the automatic file naming algorithm.

The default path for all Sequence Files is:

My Documents\Sequences

Key Path	Save, Sequences
Mode	All

Notes	Brings up Save As dialog for saving a Sequence Save Type
Initial S/W Revision	A.05.00

Data (Export)

Exporting a data file stores data from the current measurement to mass storage files. The Export Menu only contains data types that are supported by the current measurement.

Since the commonly exported data files are in .csv format, the data can be edited by you prior to importing. This allows you to export a data file, manipulate the data in Excel (the most common PC Application for manipulating .csv files) and then import it.

Selecting an Export Data menu key will not actually cause the exporting to occur, since the analyzer still needs to know where you wish to save the data. Pressing the Save As key in this menu brings up the Save As dialog and Save As menu that allows you to specify the destination file and directory. Once a filename has been selected or entered in the Open menu, the export will occur as soon as the Save key is pressed.

Key Path	Save
Mode	All
Notes	The menu is built from whatever data types are available for the mode. So the key locations in the sub menu will vary. No SCPI command directly controls the Data Type that this key controls. The Data Type is included in the MMEM:STORe commands.
Dependencies	If a file type is not used by a certain measurement, that type is grayed out for that measurement. The key for a file type will not show at all if there are no measurements in the Mode that support it.
Preset	Is not affected by a Preset or shutdown, but is reset during Restore Mode Defaults
Readback	The data type that is currently selected
Initial S/W Revision	Prior to A.02.00

Measurement Results

Pressing this key selects Meas Results as the data type to be exported.

The Meas Results file contains information which describes the current state of the analyzer. It is detailed in Meas Result File Contents below.

Key Path	Save, Data
Remote Command	:MMEMory:STORe:RESults <string>
Example	:MMEM:STOR:RES "MeasR_0000.csv"
Notes	If the save is initiated via SCPI and the file already exists, the file will be overwritten. The SCPI command exports ACP measurement results to the file specified as the parameter in the current path. The default path is My Documents\ <current mode>\data\acp\results.<br=""></current> Using the C: drive is strongly discouraged, since it runs the risk of being overwritten during an

	instrument software upgrade. The SCPI parameter is a quoted string that specifies the filename. Both single and double quotes are supported for any filename parameter over SCPI.
Dependencies	The current active measurement must be the ACP measurement to use this command.
Status Bits/OPC dependencies	Sequential – waits for the previous measurement to complete
Initial S/W Revision	Prior to A.02.00

Meas Results File Contents

A Meas Results File contains measurement results with the following information.

- File ID string, which is “MeasResult”
- Measurement ID following Mode ID, which is “SA:ACP” for example.
- Firmware rev and model number
- Option string
- Auto Scaling
- Auto Sweep Time Rules
- Automatic Trigger Time
- Automatic Trigger Time State
- Average Mode
- Average Number
- Average State
- Bar Graph
- Carrier Coupling
- Carrier Pwr Present
- Carrier Spacing
- Carriers
- Center Frequency
- Center Frequency Step
- Center Frequency Step State
- Detector Auto
- Detector Selection
- Electrical Atten

- Electrical Atten State
- External Array Trigger Delay
- External Array Trigger Delay State
- External Array Trigger Level
- External Array Trigger Slope
- Filter Alpha
- Filter BW
- Filter Type
- Internal Preamp
- Internal Preamp Band
- Limit Test
- Line Trigger Delay
- Line Trigger Delay State
- Line Trigger Slope
- Meas Method
- Meas Type
- Measurement Noise Bandwidth
- Mechanical Atten
- MechanicalAttenStepEnum
- Method
- Noise Correction
- Offset Abs Limit
- Offset Fail
- Offset Filter Alpha
- Offset Filter BW
- Offset Filter Type
- Offset Freq
- Offset Freq State
- Offset Integ BW
- Offset Method
- Offset Rel Lim (Car)

- Offset Rel Lim (PSD)
- Offset Res BW
- Offset Res BW Mode
- Offset Video BW
- Offset Video BW Mode
- Periodic Timer Period
- Periodic Timer Sync Source
- Periodic Timer Trigger Delay
- Periodic Timer Trigger Delay State
- Points
- Power Ref
- Power Ref State
- Preselector Adjust
- PSD Ref
- PSD Unit
- Ref Car Freq
- Ref Car Freq State
- Ref Carrier
- Ref Carrier Mode
- Ref Position
- Ref Value
- Res BW
- Res BW Mode
- RFBurst Trigger Delay
- RFBurst Trigger Delay State
- RFBurst Trigger Level Abs
- RFBurst Trigger Level Rel
- RFBurst Trigger Level Type
- RFBurst Trigger Slope
- Scale/Div
- Span

- Sweep Time
- Sweep Time Auto
- Trigger Holdoff
- Trigger Holdoff State
- Trigger Source
- Video BW
- Video BW Auto

The file contains these data followed by MeasResult1, MeasResult2, and MeasResult3 that flag the start of the measurement results. Each line of Measurement Results consists of three comma separated values, MeasResult1 value, MeasResult2 value, and MeasResult3 value. MeasResult1 contains the same result as MEAS/READ/FETCH:ACPower1; MeasResult2, MEAS/READ/FETCH:ACPower2; MeasResult3, MEAS/READ/FETCH:ACPower3.

Exported file is .csv file. The Meas Results file, when imported into Excel, will show the following data:

MeasResult	
SA:ACP	
A.10.53	N9030A
526 ALV ATP	1
B1X B1Y B25	
B40 BBA CR3	
CRP DCF DDA	
DP2 DRD EA3	
EDP EMC EP1	
ERC ESC ESP	
EXM FSA LFE	
LNP MAT MPB	
NFE NUL P26	
PFR PNC RTL	
RTS S40 SB1	
SEC SM1 TVT	
YAS YAV	
Auto Scaling	TRUE
Auto Sweep	Accy
Time Rules	
Automatic	0.1
Trigger Time	
Automatic	FALSE
Trigger Time	
State	
Average Mode	Exponential
Average	10
Number	

Average State	TRUE											
Bar Graph	TRUE											
Carrier Coupling	TRUE	TRUE	TRUE	TRUE	TRUE	TRUE	TRUE	TRUE	TRUE	TRUE	TRUE	TRUE
Carrier Pwr Present	Yes	Yes	Yes	Yes	Yes	Yes	Yes	Yes	Yes	Yes	Yes	Yes
Carrier Spacing	5000000	5000000	500000	500000	500000	500000	500000	500000	500000	500000	500000	500000
Carriers	1											
Center Frequency	1.33E+10											
Center Frequency Step	800000											
Center Frequency Step State	TRUE											
Detector Auto	TRUE											
Detector Selection	Average											
Electrical Atten	0											
Electrical Atten State	FALSE											
External Array Trigger Delay	1.00E-06	1.00E-06										
External Array Trigger Delay State	FALSE	FALSE										
External Array Trigger Level	1.2	1.2										
External Array Trigger Slope	Positive	Positive										
Filter Alpha	0.22	0.22	0.22	0.22	0.22	0.22	0.22	0.22	0.22	0.22	0.22	0.22
Filter BW	Minus3dB											
Filter Type	Gaussian											
Internal Preamp	FALSE											
Internal Preamp Band	Low											

Limit Test	FALSE												
Line Trigger Delay	1.00E-06												
Line Trigger Delay State	FALSE												
Line Trigger Slope	Positive												
Meas Method	lbwSpeed												
Meas Type	TPRef												
Measurement Noise Bandwidth	2000000	2000000	200000	200000	200000	200000	200000	200000	200000	200000	200000	200000	200000
Mechanical Atten	10												
MechanicalAtt enStepEnum	S2dB												
Method	IBW	IBW	IBW	IBW	IBW	IBW	IBW	IBW	IBW	IBW	IBW	IBW	IBW
Noise Correction	FALSE												
Offset Abs Limit	0	0	0	0	0	0	0	0	0	0	0	0	0
Offset Fail	Relative	Relative	Relative	Relative	Relative	Relative	Relative	Relative	Relative	Relative	Relative	Relative	Relative
Offset Filter Alpha	0.22												
Offset Filter BW	Minus3dB	Minus3dB	Minus3dB	Minus3dB	Minus3dB	Minus3dB	Minus3dB	Minus3dB	Minus3dB	Minus3dB	Minus3dB	Minus3dB	Minus3dB
Offset Filter Type	Gaussian	Gaussian	Gaussian	Gaussian	Gaussian	Gaussian	Gaussian	Gaussian	Gaussian	Gaussian	Gaussian	Gaussian	Gaussian
Offset Freq	3000000	0	0	0	0	0	0	0	0	0	0	0	0
Offset Freq State	TRUE	FALSE	FALSE	FALSE	FALSE	FALSE	FALSE	FALSE	FALSE	FALSE	FALSE	FALSE	FALSE
Offset Integ BW	2000000	2000000	200000	200000	200000	200000	200000	200000	200000	200000	200000	200000	200000
Offset Method	FALSE												
Offset Rel Lim (Car)	-45	-60	0	0	0	0	0	0	0	0	0	0	0
Offset Rel Lim (PSD)	-28.87	-43.87	0	0	0	0	0	0	0	0	0	0	0

Offset Res BW	220000	220000	220000	220000	220000	220000
Offset Res BW Mode	TRUE	TRUE	TRUE	TRUE	TRUE	TRUE
Offset Video BW	22000	22000	22000	22000	22000	22000
Offset Video BW Mode	TRUE	TRUE	TRUE	TRUE	TRUE	TRUE
Periodic Timer Period	0.02					
Periodic Timer Sync Source	None					
Periodic Timer Trigger Delay	1.00E-06					
Periodic Timer Trigger Delay State	FALSE					
Points	1001					
Power Ref	-76.81 dBm					
Power Ref State	On					
Preselector Adjust	0					
PSD Ref	-139.82 dBm/Hz					
PSD Unit	DbmHz					
Ref Car Freq	13.255000000 GHz					
Ref Car Freq State	On					
Ref Carrier	1					
Ref Carrier Mode	On					
Ref Position	Top					
Ref Value	-30					
Res BW	220000					
Res BW Mode	FALSE					
RFBurst Trigger Delay	1.00E-06					
RFBurst Trigger Delay	FALSE					

State		
RFBurst Trigger Level Abs	-20	
RFBurst Trigger Level Rel	-6	
RFBurst Trigger Level Type	Absolute	
RFBurst Trigger Slope	Positive	
Scale/Div	10	
Span	8000000	
Sweep Time	0.02	
Sweep Time Auto	TRUE	
Trigger Holdoff	0.1	
Trigger Holdoff State	FALSE	
Trigger Source	Free	
Video BW	22000	
Video BW Auto	TRUE	
MeasResult1	MeasResult 2	Meas Result 3
- 76.80585177 44559	0	1
0.084790019 950006	- 76.80585 17744559	0
0.028392912 8313787	-999	1
	-999	0
	-999	1

Capture Buffer

This function allows you to store captured data for reuse in demod measurements using 'Save/Recall' functionality for 'Capture Buffer'. (This function is enabled for 'Code Domain' and 'Modulation Accuracy' measurements ONLY)

'Capture Buffer' is saved and loaded as IQ Data with properties which show Sample Rate, Length, IF BW, etc.

Use-Case are as followings;

Use Capture Buffer to perform analysis of the same captured data using 'Code Domain' and 'Modulation Accuracy' measurements, or to playback previously saved captured data.

Key Path	Save, Data
Mode	CDMA2000
Example	MMEM:STOR:CAPT "MyCaptureData.bin" This stores the capture data in the file MyCaptureData.bin in the default directory.
Dependencies	Capture buffer functionality is only available for Code Domain and Modulation Accuracy measurement. In other measurements, this key is grayed out.
Initial S/W Revision	Prior to A.02.00

Save As . . .

When you press "Save As", the analyzer brings up a Windows dialog and a menu entitled "**Save As.**" This menu allows you to navigate to the various fields in the Windows dialog without using a keyboard or mouse. The Tab and Arrow keys can also be used for dialog navigation.

See "[To File . . .](#)" on page 2070 in Save, State for a full description of this dialog and menu.

The default path for saving files is:

For all of the Trace Data Files:

My Documents\<<mode name>\data\traces

For all of the Limit Data Files:

My Documents\<<mode name>\data\limits

For all of the Measurement Results Data Files:

My Documents\<<mode name>\data\<<measurement name>\results

For all of the Capture Buffer Data Files:

My Documents\<<mode name>\data\captureBuffer

Key Path	Save, Data
Mode	All
Notes	The key location is mode-dependent and will vary. Brings up the Save As dialog for saving a <mode specific> Save Type. The save is performed immediately and does not wait until the measurement is complete.
Initial S/W Revision	Prior to A.02.00

Screen Image

Pressing Screen Image accesses a menu of functions that enable you to specify a format and location for the saved screen image. It brings up a menu that allows you to specify the color scheme of the Screen Image (Themes) or navigate to the Save As dialog to perform the actual save.

Screen Image files contain an exact representation of the analyzer display. They cannot be loaded back onto the analyzer, but they can be loaded into your PC for use in many popular applications.

The image to be saved is actually captured when the Save front panel key is pressed, and kept in temporary storage to be used if you ask for a Screen Image save. When the Screen Image key is pressed, a "thumbnail" of the captured image is displayed, as shown below:

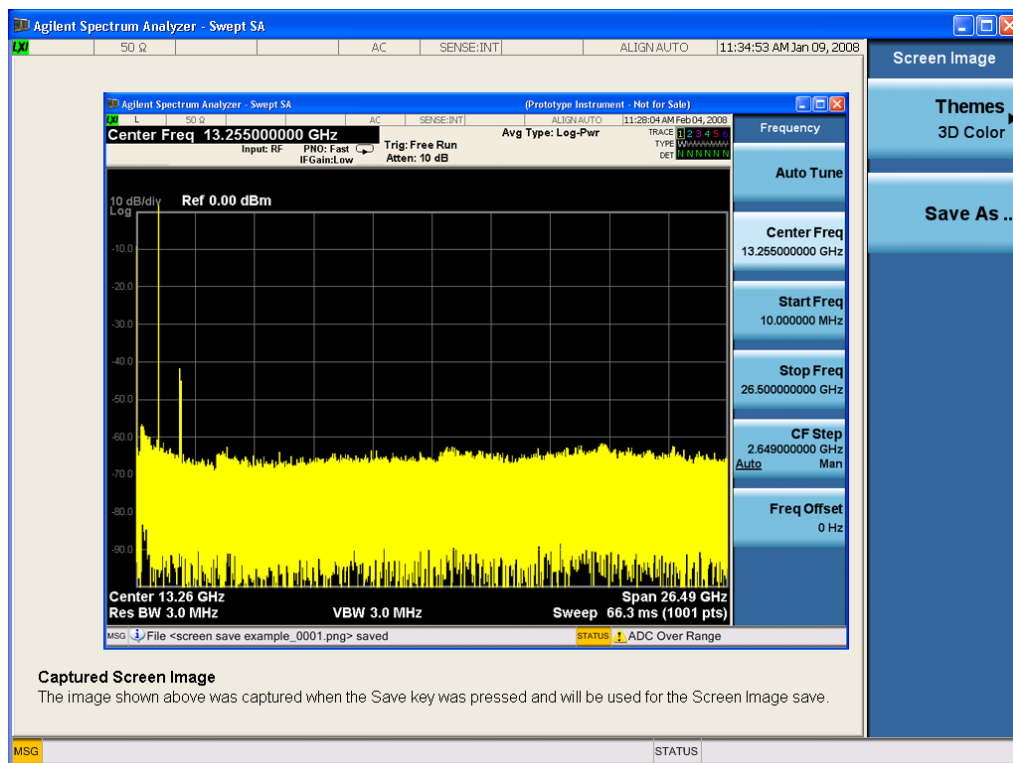

When you continue on into the Save As menu and complete the Screen Image save, the image depicted in the thumbnail is the one that gets saved, showing the menus that were on the screen before going into the Save menu. The save is performed immediately and does not wait until the measurement is complete.

After you have completed the save, the Quick Save front-panel key lets you quickly repeat the last save performed, using an auto-named file, with the current screen data.

NOTE

For versions previous to A.01.55, if you initiate a screen image save by navigating through the Save menus, the image that is saved will contain the Save menu softkeys, not the menu and the active function that were on the screen when you first pressed the Save front panel key.

Key Path	Save
Mode	All

Remote Command	:MMEMory:STORe:SCReen <filename>
Example	:MMEM:STOR:SCR "myScreen.png" This stores the current screen image in the file MyScreenFile.png in the default directory.
Initial S/W Revision	Prior to A.02.00

Themes

Accesses a menu of functions that enable you to choose the theme to be used when saving the screen image.

The **Themes** option is the same as the **Themes** option under the **Display** and **Page Setup** dialogs. It allows you to choose between themes to be used when saving the screen image.

Key Path	Save, Screen Image
Remote Command	:MMEMory:STORe:SCReen:THEMe TDColor TDMonochrome FCOLor FMONochrome :MMEMory:STORe:SCReen:THEMe?
Example	:MMEM:STOR:SCR:THEM TDM
Preset	3D Color; Is not part of Preset, but is reset by Restore Misc Defaults or Restore System Defaults All and survives subsequent running of the modes.
Readback	3D Color 3D Mono Flat Color Flat Mono
Backwards Compatibility Notes	In ESA and PSA we offer the choice of "Reverse Bitmap" or "Reverse Metafile" when saving screen images. This is much like the "Flat Color" theme available in X-Series. Also, if you selected Reverse Bitmap AND a black & white screen image, that would be much like "Flat Monochrome". In other words, each of the X-Series themes has a similar screen image type in ESA/PSA. But they are not identical.
Initial S/W Revision	Prior to A.02.00

3D Color

Selects a standard color theme with each object filled, shaded and colored as designed.

Key Path	Save, Screen Image, Themes
Example	MMEM:STOR:SCR:THEM TDC
Readback	3D Color
Initial S/W Revision	Prior to A.02.00

3D Monochrome

Selects a format that is like 3D color but shades of gray are used instead of colors.

Key Path	Save, Screen Image, Themes
Example	MMEM:STOR:SCR:THEM TDM
Readback	3D Mono
Initial S/W Revision	Prior to A.02.00

Flat Color

Selects a format that is best when the screen is to be printed on an ink printer.

Key Path	Save, Screen Image, Themes
Example	MMEM:STOR:SCR:THEM FCOL
Readback	Flat Color
Initial S/W Revision	Prior to A.02.00

Flat Monochrome

Selects a format that is like Flat Color. But only black is used (no colors, not even gray), and no fill.

Key Path	Save, Screen Image, Themes
Example	MMEM:STOR:SCR:THEM FMON
Readback	Flat Mono
Initial S/W Revision	Prior to A.02.00

Save As...

When you press "Save As", the analyzer brings up a Windows dialog and a menu entitled "**Save As.**" This menu allows you to navigate to the various fields in the Windows dialog without using a keyboard or mouse. The Tab and Arrow keys can also be used for dialog navigation.

See "[To File . . .](#)" on page 2070 in Save, State for a full description of this dialog and menu.

The default path for Screen Images is

My Documents\`<mode name>`\screen.

where `<mode name>` is the parameter used to select the mode with the INST:SEL command (for example, SA for the Spectrum Analyzer).

Key Path	Save, Screen Image
Notes	Brings up Save As dialog for saving a Screen Image Save Type
Initial S/W Revision	Prior to A.02.00

Single (Single Measurement/Sweep)

Sets the analyzer for Single measurement operation. The single/continuous state is Meas Global, so the setting will affect all the measurements. If you are Paused, pressing Single does a Resume.

See "[More Information](#)" on page 704

Key Path	Front-panel key
Example	:INIT:CONT OFF
Notes	See Cont key description.
Backwards Compatibility Notes	<p>For Spectrum Analysis mode in ESA and PSA, the Single hardkey and the INITiate:IMM switched from continuous measurement to single measurement and restarted sweeps and averages (displayed average count reset to 1), but did not restart Max Hold and Min Hold. In the X-Series, the Single hardkey and the INITiate:IMM command initiate a sweep/ measurement/ average sequence/hold sequence including MaxHold and MinHold.</p> <p>For Spectrum Analysis mode in ESA and PSA, the Single hardkey restarted the sweep regardless of whether or not you were in an active sweep or sweep sequence. In the X-Series, Restart does this but Single only restarts the sweep or sweep sequence if you are in the idle state.</p> <p>INIT[:IMM] in ESA & PSA Spectrum Analysis Mode does an implied ABORT. In some other PSA Modes, INIT[:IMM] is ignored if not in the idle state. . The X-Series follows the ESA/PSA SA Mode model, which may cause some Modes to have compatibility problems.</p>
Initial S/W Revision	Prior to A.02.00

More Information

See "[Restart](#)" on page 2067 for details on the INIT:IMMEDIATE (Restart) function.

If you are already in single sweep, the INIT:CONT OFF command has no effect.

If you are already in Single Sweep, then pressing the Single key in the middle of a sweep does not restart the sweep or sequence. Similarly, pressing the Single key does not restart the sweep or sequence if the sweep is not in the idle state (for example, if you are taking a very slow sweep, or the analyzer is waiting for a trigger). Instead, it results in a message. "Already in Single, press Restart to initiate a new sweep or sequence". Even though pressing the Single key in the middle of a sweep does not restart the sweep, sending INIT:IMMEDIATE does reset it.

To take one more sweep without resetting the average count, increment the average count by 1, by pressing the step up key while **Average/Hold Number** is the active function, or sending the remote command CALC:AVER:TCON UP.

Source

Opens a menu of keys that access various source configuration menus and settings. In the test set, pressing this key also causes the central view area to change and display the Source Control Main view.

Key Path	Front-panel key
----------	-----------------

RF Output

This parameter sets the source RF power output state.

Key Path	Source
Remote Command	:OUTPut[:EXTernal][:STATe] ON OFF 1 0 :OUTPut[:EXTernal][:STATe]?
Example	OUTP OFF OUTP?
Notes	<p>The EXTERNAL node is shown in RD text so the SCPI remains the same between internal and external source control. However, for EXT we do not wish to document this node to the customer since we are controlling the internal source rather than the external source.</p> <p>This setting is for the independent mode and has no effect on the "List Sequencer" on page 2168. If the "Sequencer" on page 2168 is set to ON, the list sequencer controls the source output and this key will be grayed-out. And this setting will be none-forceful grey out on front panel to indicate out-of-scope. Non-forceful means user still can change this setting by SCPI but cannot change on front panel. When set to OFF will make source leave list sequencer and this setting will be black out and take effect immediately.</p> <p>When the RF Output is ON, an "RF" annunciator is displayed in the system settings panel. When the RF Output is turned Off, the RF annunciator is cleared. If the "Sequencer" on page 2168 is set to ON, the "RF" annunciator will be replaced by "SEQ" in the system settings panel, indicating that the output is controlled by the list sequencer.</p>
Preset	Off
Range	On Off
Initial S/W Revision	A.05.00

Amplitude

Allows you to access the Amplitude sub-menu.

Key Path	Source
Notes	<p>The sub-menu under this button is for independent mode and has no effect on "List Sequencer" on page 2168. If the "Sequencer" on page 2168 is set to ON, the list sequencer controls the source output and this key will be grayed-out on front panel to indicate out-of-scope. When you set "Sequencer" on page 2168 to Off will make source leave list sequencer and this button will be black out.</p>
Initial S/W Revision	A.05.00

RF Power

Allows you to adjust the power level of the source using the numeric keypad, step keys, or RPG. Pressing any digit, 0 through 9, on the numeric keypad brings up the unit terminator.

Please refer to the "[RF Power Range](#) " on page 707 table below for the valid ranges.

Key Path	Source, Amplitude
Remote Command	:SOURce:POWer[:LEVel][:IMMediate][:AMPLitude] <ampl> :SOURce:POWer[:LEVel][:IMMediate][:AMPLitude]?
Example	:SOUR:POW -100 dBm
Notes	<p>Amplitude corrections can be specified for use with the source. In the event of amplitude corrections being applied, the valid ranges for the RF power do not change dependant on the current amplitude correction setting. If the combination of RF power + amplitude correction is higher or lower than the source output range, the Source Unleveled bit is set and the "Source Unleveled" indicator will appear on status panel to indicate that the source cannot maintain the output power that has been requested.</p> <p>When signal generator is unable to maintain the requested output level, the "Source Unleveled" indicator will appear on status panel. When the source output setting is restored to the normal range, the "Source Unleveled" is removed from status panel.</p> <p>Internal source has list sequence mode, which comprises of several steps which contain separate output power, frequency and waveform etc. When the source list sequence playing is complete, the last step keeps playing, and user can use this command to change the list sequence last step's output power.</p> <p>The multiport adapter RFIO TX ports and GPS ports cannot ensure power accuracy when power setting is lower than -130dBm, this power setting value is defined by the sum of RF Power setting and related amplitude correction value. But user settable value could be lower than this limit. When application detected there exists power setting lower than -130dBm on MPA RFIO TX ports, then popup warning message . When application detected there exists power setting lower than -130dBm on MPA GPS ports, then popup warning message . This is only warning message, and check is performed when RF is ON.</p>
Notes	The Min and Max value here defined UI settable amplitude range. This range is larger than actual amplitude range with level accuracy defined in spec.
Dependencies	The RF power is dependent on the RF output port and frequency, such that the current frequency and selected output port determine the valid range of power values.
Preset	-100 dBm
Min	The range of values depends on the current frequency and selected RF output port. Please refer to the " RF Power Range " on page 707 table below for the valid ranges.
Max	The range of values depends on the current frequency and selected RF output port. Please refer to the " RF Power Range " on page 707 table below for the valid ranges.
Initial S/W Revision	A.05.00

All other models:

RF Power Range

RF Output Port	Frequency Range	Min Output Power	Max Output Power
High Power RF Out	10 MHz \leq f \leq 6 GHz	-150 dBm	20 dBm
RFIO 1 & RFIO 2	10 MHz \leq f \leq 6 GHz	-150 dBm	0 dBm
GPS (Note2)	10 MHz \leq f \leq 6 GHz	-150 dBm	0 dBm

Note: This is the UI power range, it's larger than actual spec.

Note2: GPS port is on the multiport adapter, or E6607C which has embedded MPA.

M9420A:

RF Power Range

RF Output Port	Frequency Range	Min Output Power	Max Output Power without Option "1EA"	Max Output Power with Option "1EA"
RF Output	60 MHz \leq f \leq 6 GHz	-150 dBm	10 dBm	18 dBm
RFHD	60 MHz \leq f \leq 6 GHz	-150 dBm	10 dBm	15 dBm
RFFD	60 MHz \leq f \leq 6 GHz	-150 dBm	0 dBm	0 dBm

Set Reference Power

This key allows you to set the power reference. Pressing this key turns the power reference state to ON, sets the reference power value to the current RF output power, maintains this power at the RF output, and sets the displayed power to 0.00 dB. All subsequent RF power values entered under Source>Amplitude>RF Power are interpreted as being relative to this reference power.

When you use a power reference, the signal generator outputs an RF power that is set relative to the reference power by the value entered under Source>Amplitude>RF Power as follows:

Output power = reference power – entered power

Where:

reference power equals the original RF Power entered under Source>Amplitude>RF Power and set as the reference power

entered power equals a new value entered under Source>Amplitude>Amptd Offset

In addition, the displayed power value is the same as a new value entered under Source>Amplitude>RF Power.

NOTE

If Power Ref is set to ON with a reference value set, entering a value under Source>Amplitude>RF Power and pressing Set Reference Power will add that value to the existing Power Ref value.

If you wish to change the reference power value to a new value entered under Source>Amplitude>RF Power, first you must set Power Ref to OFF and then press Set Reference Power.

Key Path	Source, Amplitude
Dependencies	This key is unavailable, and is grayed out when the "List Sequencer" on page 2168 is turned ON.
Initial S/W Revision	A.05.00

Power Ref

This key allows you to toggle the state of the power reference.

When you use a power reference, the signal generator outputs an RF power that is set relative to the reference power by the value entered under Source>Amplitude>RF Power as follows:

Output power = reference power + entered power

Where:

reference power equals the original RF Power entered under Source>Amplitude>RF Power and set as the reference power

entered power equals a new value entered under Source>Amplitude>Amptd Offset

For more information on Reference Frequency refer to ["Set Reference Power " on page 2099](#)

Key Path	Source, Amplitude
Remote Command	:SOURce:POWer:REFeRence <ampl> :SOURce:POWer:REFeRence? :SOURce:POWer:REFeRence:STATe OFF ON 0 1 :SOURce:POWer:REFeRence:STATe?
Example	:SOUR:POW:REF 0.00 dBm :SOUR:POW:REF:STATe ON
Dependencies	This setting is unavailable and is grayed out when the "List Sequencer" on page 2168 is turned ON.
Couplings	This value is coupled to the "Set Reference Power " on page 2099 key such that pressing the Set Reference Power key updates the reference power with the current output power.
Preset	0.00 dBm OFF
Min	-125.00 dBm
Max	10.00 dBm
Initial S/W Revision	A.05.00

Amptd Offset

Allows you to specify the RF output power offset value.

When the amplitude offset is set to zero (0) and you set a new offset value (positive or negative), the displayed amplitude value will change as follows and the RF output power will not change:

Displayed value = output power + offset value

Where:

output power equals the original RF Power entered under Source>Amplitude>RF Power

offset value equals the value entered under Source>Amplitude>Amptd Offset

When the amplitude offset is set to a value other than zero (0) and you enter a new RF power value under Source>Amplitude>RF Power, the displayed power will be the same as the value entered and the RF output power will be equal to the value entered minus the offset value as follows:

Output power = entered power – offset power

Displayed Power = output power + offset power

Displayed power = entered power

Where:

entered power equals the amplitude entered under Source>Amplitude>RF Power

offset power equals the value previously entered and set under Source>Amplitude>Amptd Offset

Key Path	Source, Amplitude
Remote Command	:SOURce:POWer[:LEVel][:IMMediate]:OFFSet <rel_ampl> :SOURce:POWer[:LEVel][:IMMediate]:OFFSet?
Example	:SOUR:POW:OFFS 0.00 dB
Dependencies	This setting is unavailable, and is grayed out when the List Sequencer is turned ON.
Preset	0.00 dB
Min	-200.00 dB
Max	200.00 dB
Initial S/W Revision	A.05.00

Modulation

Allows you to toggle the state of the modulation.

Key Path	Source
Remote Command	:OUTPut:MODulation[:STATe] ON OFF 1 0 :OUTPut:MODulation[:STATe]?
Example	:OUTP:MOD OFF
Notes	This setting is for independent mode and has no effect on " List Sequencer " on page 2168. If the " Sequencer " on page 2168 is set to ON, the list sequencer controls the source output and this key will be grayed-out. And this setting will be none-forceful grey out on front panel to indicate out-of-scope. Non-forceful means user still can change this setting by SCPI but cannot change manually on front panel. When set to Off will make source leave list sequencer and this setting will be black out and take effect immediately. When the Modulation is ON, the "MOD" annunciator is displayed in the system settings panel. When the Modulation is turned Off, the "MOD" annunciator is cleared. If the

"Sequencer" on page 2168 is set to ON, the "MOD" annunciator will be replaced by "SEQ" in the system settings panel indicating that the output is controlled by list sequencer.

Preset	Off
Range	On Off
Initial S/W Revision	A.05.00

Frequency

Allows you to access the Frequency sub-menu.

Key Path	Source
Notes	The sub-menu under this button is for independent mode and has no effect on "List Sequencer" on page 2168. If the "Sequencer" on page 2168 is set to ON, the list sequencer controls the source output and this key will be grayed-out. And this button will be grey out on front panel to indicate out-of-scope. When set to Off will make source leave list sequencer and this button will be black out.
Initial S/W Revision	A.05.00

Frequency

Allows you to set the RF Output Frequency. You can adjust the frequency of the source using the numeric keypad, step keys, or RPG. Pressing any digit, 0 through 9, on the numeric keypad brings up the unit terminator.

Key Path	Source, Frequency
Remote Command	:SOURce:FREQuency[:CW] <freq> :SOURce:FREQuency[:CW]?
Example	:SOUR:FREQ 1.00 GHz
Notes	Internal source has list sequence mode, which comprises of several steps which contain separate output power, frequency and waveform etc. When the source list sequence playing is complete, the last step keeps playing, and user can use this command to change the list sequence last step's output frequency.
Couplings	The frequency value is coupled to the current channel band and number, such that updates to the band and number will update the frequency value to the corresponding absolute frequency.
Preset	1.00 GHz If license F1A or 5WC is present, the default Center Frequency should be 2.412GHz.
Min	10.00 MHz
Max	Hardware Dependant: Option 503 = 3.6 GHz Option 504 = 3.8 GHz Option 506 = 6.00 GHz For E6640A, if license 5WC is present, the frequency range should be limited to: 1.1GHz-1.7GHz,

2.4GHz–2.5GHz, 4.8GHz–6.0GHz. If the user-defined frequency is outside of range, UI will report an error message called "Settings conflict; Frequency is outside available range".

Initial S/W Revision A.05.00

Channel

The frequency of the source can be specified by a channel number of a given frequency band. This key allows you to specify the current channel number. For the appropriate range of channel numbers for a given frequency band, refer to the following tables: ["GSM/EDGE Channel Number Ranges" on page 711](#), ["W-CDMA Channel Number Ranges" on page 712](#), ["CDMA 2000 / 1xEVDO Channel Number Ranges" on page 714](#), and ["LTE FDD Channel Number Ranges" on page 716](#).

Key Path	Source, Frequency
Remote Command	:SOURce:FREQuency:CHANnels:NUMBer <int> :SOURce:FREQuency:CHANnels:NUMBer?
Example	:SOUR:FREQ:CHAN:NUMB 1
Notes	This key is grayed out when the "Radio Standard" on page 2111 is set to NONE. This key is grayed out on E6630A.
Dependencies	This key is grayed out when the "Radio Standard" on page 2111 is set to NONE. This key is grayed out on E6630A.
Couplings	The channel number is coupled to the frequency value when the "Radio Standard" on page 2111 is not set to NONE. When the frequency value is changed, the channel number will increase or decrease to match the new frequency. If the frequency is not at an exact match for a channel number, the nearest channel number is displayed along with a greater than or less than sign to indicate the frequency is above or below the channel number.
Preset	1
Min	Please refer to the tables below for the valid ranges.
Max	Please refer to the tables below for the valid ranges.
Initial S/W Revision	A.05.00

GSM/EDGE Channel Number Ranges

Band	Link (Device)	Range	Frequency (MHz)
P-GSM	Uplink (MS)	$1 \leq n \leq 124$	$890.0 + 0.2*n$
	Downlink (BS)	$1 \leq n \leq 124$	$935.0 + 0.2*n$
E-GSM	Uplink (MS)	$0 \leq n \leq 124$	$890.0 + 0.2*n$
		$975 \leq n \leq 1023$	$890.0 + 0.2*(n-1024)$
	Downlink (BS)	$0 \leq n \leq 124$	$935.0 + 0.2*n$
		$975 \leq n \leq 1023$	$935.0 + 0.2*(n-1024)$

Band	Link (Device)	Range	Frequency (MHz)
DCS 1800	Uplink (MS)	$512 \leq n \leq 885$	$1710.200 + 0.20*(n-512)$
	Downlink (BS)	$512 \leq n \leq 885$	$1805.200 + 0.20*(n-512)$
PCS 1900	Uplink (MS)	$512 \leq n \leq 810$	$1850.200 + 0.2*(n-512)$
	Downlink (BS)	$512 \leq n \leq 810$	$1930.200 + 0.2*(n-512)$
R-GSM	Uplink (MS)	$0 \leq n \leq 124$	$890.0 + 0.2*n$
		$955 \leq n \leq 1023$	$890.0 + 0.2*(n-1024)$
	Downlink (BS)	$0 \leq n \leq 124$	$935.0 + 0.2*n$
		$955 \leq n \leq 1023$	$935.0 + 0.2*(n-1024)$
GSM 450	Uplink (MS)	$256 \leq n \leq 293$	$450.6 + 0.2*(n-259)$
	Downlink (BS)	$256 \leq n \leq 293$	$460.6 + 0.2*(n-259)$
GSM 480	Uplink (MS)	$306 \leq n \leq 340$	$479.000 + 0.20*(n-306)$
	Downlink (BS)	$306 \leq n \leq 340$	$489.000 + 0.20*(n-306)$
GSM 850	Uplink (MS)	$128 \leq n \leq 251$	$824.200 + 0.20*(n-128)$
	Downlink (BS)	$128 \leq n \leq 251$	$869.200 + 0.20*(n-128)$
GSM 700	Uplink (MS)	$438 \leq n \leq 516$	$777.200 + 0.20*(n-438)$
	Downlink (BS)	$438 \leq n \leq 516$	$747.200 + 0.20*(n-438)$
T-GSM810	Uplink (MS)	$350 \leq n \leq 425$	$806.0 + 0.20*(n-350)$
	Downlink (BS)	$350 \leq n \leq 425$	$851.0 + 0.20*(n-350)$

W-CDMA Channel Number Ranges

Band	Link (Device)	Range	Frequency (MHz)
Band I	Downlink	$10562 \leq n \leq 10838$	$n \div 5$
	Uplink	$9612 \leq n \leq 9888$	$n \div 5$
Band II	Downlink	$412 \leq n \leq 687$	$n \div 5 + 1850.1$
		$9662 \leq n \leq 9938$	$n \div 5$
	Uplink	$12 \leq n \leq 287$	$n \div 5 + 1850.1$
		$350 \leq n \leq 425$	$n \div 5$
Band III	Downlink	$1162 \leq n \leq 1513$	$n \div 5 + 1575$
	Uplink	$937 \leq n \leq 1288$	$n \div 5 + 1525$
Band IV	Downlink	$537 \leq n \leq 1738$	$n \div 5 + 1805$
		$1887 \leq n \leq 2087$	$n \div 5 + 1735.1$
	Uplink	$1312 \leq n \leq 1513$	$n \div 5 + 1450$
		$1662 \leq n \leq 1862$	$n \div 5 + 1380.1$
Band V	Downlink	$1007 \leq n \leq 1087$	$n \div 5 + 670.1$
		$4357 \leq n \leq 4458$	$n \div 5$

Band	Link (Device)	Range	Frequency (MHz)
	Uplink	$782 \leq n \leq 862$	$n \div 5 + 670.1$
		$4132 \leq n \leq 4233$	$n \div 5$
Band VI	Downlink	$1037 \leq n \leq 1062$	$n \div 5 + 670.1$
		$4387 \leq n \leq 4413$	$n \div 5$
	Uplink	$812 \leq n \leq 837$	$n \div 5 + 670.1$
		$4162 \leq n \leq 4188$	$n \div 5$
Band VII	Downlink	$2237 \leq n \leq 2563$	$n \div 5 + 2175$
		$2587 \leq n \leq 2912$	$n \div 5 + 2105.1$
	Uplink	$2012 \leq n \leq 2338$	$n \div 5 + 2100$
		$2362 \leq n \leq 2687$	$n \div 5 + 2030.1$
Band VIII	Downlink	$2937 \leq n \leq 3088$	$n \div 5 + 340$
	Uplink	$2712 \leq n \leq 2863$	$n \div 5 + 340$
Band IX	Downlink	$9237 \leq n \leq 9387$	$n \div 5$
	Uplink	$8762 \leq n \leq 8912$	$n \div 5$
Band X	Downlink	$3112 \leq n \leq 3388$	$n \div 5 + 1490$
		$3412 \leq n \leq 3687$	$n \div 5 + 1430.1$
	Uplink	$2887 \leq n \leq 3163$	$n \div 5 + 1135$
		$3187 \leq n \leq 3462$	$n \div 5 + 1075.1$
Band XI	Downlink	$3712 \leq n \leq 3812$	$n \div 5 + 736$
	Uplink	$3487 \leq n \leq 3587$	$n \div 5 + 733$
Band XII	Downlink	$3837 \leq n \leq 3903$	$n \div 5 - 37$
		$3927 \leq n \leq 3992$	$n \div 5 - 54.9$
	Uplink	$3612 \leq n \leq 3678$	$n \div 5 - 22$
		$3702 \leq n \leq 3767$	$n \div 5 - 39.9$
Band XIII	Downlink	$4017 \leq n \leq 4043$	$n \div 5 - 55$
		$4067 \leq n \leq 4092$	$n \div 5 - 64.9$
	Uplink	$3792 \leq n \leq 3818$	$n \div 5 + 21$
		$3702 \leq n \leq 3767$	$n \div 5 - 39.9$
Band XIV	Downlink	$4117 \leq n \leq 4143$	$n \div 5 - 63$
		$4167 \leq n \leq 4192$	$n \div 5 - 72.9$
	Uplink	$3892 \leq n \leq 3918$	$n \div 5 + 12$
		$3942 \leq n \leq 3967$	$n \div 5 + 2.1$
Band XIX	Downlink	$712 \leq n \leq 763$	$n \div 5 + 735$
		$787 \leq n \leq 837$	$n \div 5 + 720.1$
	Uplink	$312 \leq n \leq 363$	$n \div 5 + 770$
		$387 \leq n \leq 437$	$n \div 5 + 755.1$

CDMA 2000 / 1xEVDO Channel Number Ranges

Band	Link (Device)	Range	Frequency (MHz)
US Cellular	Uplink (MS, reverse link)	$1 \leq N \leq 799$	$0.030 \times N + 825.000$
		$991 \leq N \leq 1023$	$0.030 \times (N - 1023) + 825.000$
		$1024 \leq N \leq 1323$	$0.030 \times (N - 1024) + 815.040$
	Downlink (BS, forward link)	$1 \leq N \leq 799$	$0.030 \times N + 870.000$
		$991 \leq N \leq 1023$	$0.030 \times (N - 1023) + 870.000$
		$1024 \leq N \leq 1323$	$0.030 \times (N - 1024) + 860.040$
US PCS	Uplink (MS, reverse link)	$0 \leq N \leq 1199$	$1850.000 + 0.050 \times N$
	Downlink (BS, forward link)	$0 \leq N \leq 1199$	$1930.000 + 0.050 \times N$
Japan Cellular Band	Uplink (MS, reverse link)	$1 \leq N \leq 799$	$0.0125 \times (N + 915.000)$
		$801 \leq N \leq 1039$	$0.0125 \times (N - 800) + 898.000$
		$1041 \leq N \leq 1199$	$0.0125 \times (N - 1040) + 887.000$
		$1201 \leq N \leq 1600$	$0.0125 \times (N - 1200) + 893.000$
	Downlink (BS, forward link)	$1 \leq N \leq 799$	$0.0125 \times (N + 860.000)$
		$801 \leq N \leq 1039$	$0.0125 \times (N - 800) + 843.000$
		$1041 \leq N \leq 1199$	$0.0125 \times (N - 1040) + 832.000$
		$1201 \leq N \leq 1600$	$0.0125 \times (N - 1200) + 838.000$
Korean PCS Band	Uplink (MS, reverse link)	$0 \leq N \leq 599$	$0.050 \times N + 1750.000$
	Downlink (BS, forward link)	$0 \leq N \leq 599$	$0.050 \times N + 1840.000$
NMT-450 Band	Uplink (MS, reverse link)	$1 \leq N \leq 400$	$0.025 \times (N - 1) + 450.000$
		$472 \leq N \leq 871$	$0.025 \times (N - 472) + 410.000$
		$1039 \leq N \leq 1473$	$0.020 \times (N - 1024) + 451.010$
		$1536 \leq N \leq 1715$	$0.025 \times (N - 1536) + 479.000$
		$1792 \leq N \leq 2016$	$0.020 \times (N - 1792) + 479.000$
	Downlink (BS, forward link)	$1 \leq N \leq 400$	$0.025 \times (N - 1) + 460.000$
		$472 \leq N \leq 871$	$0.025 \times (N - 472) + 420.000$
		$1039 \leq N \leq 1473$	$0.020 \times (N - 1024) + 461.010$
		$1536 \leq N \leq 1715$	$0.025 \times (N - 1536) + 489.000$
		$1792 \leq N \leq 2016$	$0.020 \times (N - 1792) + 489.000$
IMT-2000 Band	Uplink (MS, reverse link)	$0 \leq N \leq 1199$	$1920.000 + 0.050 \times N$
	Downlink (BS, forward link)	$0 \leq N \leq 1199$	$2100.000 + 0.050 \times N$
Upper 700 MHz Band	Uplink (MS, reverse link)	$0 \leq N \leq 240$	$776.000 + 0.050 \times N$
	Downlink (BS, forward link)	$0 \leq N \leq 240$	$746.000 + 0.050 \times N$

Band	Link (Device)	Range	Frequency (MHz)
	forward link)		
Secondary 800 MHz Band	Uplink (MS, reverse link)	$0 \leq N \leq 719$ $720 \leq N \leq 919$	$0.025 \times N + 806.000$ $0.025 \times (N - 720) + 896.000$
	Downlink (BS, forward link)	$0 \leq N \leq 719$ $720 \leq N \leq 919$	$0.025 \times N + 851.000$ $0.025 \times (N - 720) + 935.000$
2.5 GHz IMT Extension	Uplink (MS, reverse link)	$0 \leq N \leq 1399$	$2500.000 + 0.050 \times N$
	Downlink (BS, forward link)	$0 \leq N \leq 1399$	$2620.000 + 0.050 \times N$
US PCS 1.9 GHz	Uplink (MS, reverse link)	$0 \leq N \leq 1299$	$1850.000 + 0.050 \times N$
	Downlink (BS, forward link)	$0 \leq N \leq 1299$	$1930.000 + 0.050 \times N$
AWS	Uplink (MS, reverse link)	$0 \leq N \leq 899$	$1710.000 + 0.050 \times N$
	Downlink (BS, forward link)	$0 \leq N \leq 899$	$2100.000 + 0.050 \times N$
US 2.5 GHz	Uplink (MS, reverse link)	$140 \leq N \leq 1459$	$2495.000 + 0.050 \times N$
	Downlink (BS, forward link)	$140 \leq N \leq 1459$	$2617.000 + 0.050 \times N$
700 Public Safety	Uplink (MS, reverse link)	$0 \leq N \leq 240$	$787.000 + 0.050 \times N$
	Downlink (BS, forward link)	$0 \leq N \leq 240$	$757.000 + 0.050 \times N$
C2K Lower 700	Uplink (MS, reverse link)	$0 \leq N \leq 360$	$698.000 + 0.050 \times N$
	Downlink (BS, forward link)	$0 \leq N \leq 360$	$728.000 + 0.050 \times N$
400 Euro PAMR	Uplink (MS, reverse link)	$1 \leq N \leq 400$	$0.025 \times (N - 1) + 450.000$
		$472 \leq N \leq 871$	$0.025 \times (N - 472) + 410.000$
	Uplink (MS, reverse link)	$1536 \leq N \leq 1715$	$0.025 \times (N - 1536) + 479.000$
	Uplink (MS, reverse link)		
	Downlink (BS, forward link)	$1 \leq N \leq 400$	$0.025 \times (N - 1) + 460.000$
		$472 \leq N \leq 871$	$0.025 \times (N - 472) + 420.000$
	Downlink (BS, forward link)	$1536 \leq N \leq 1715$	$0.025 \times (N - 1536) + 489.000$
	Downlink (BS, forward link)		

Band	Link (Device)	Range	Frequency (MHz)
800 PAMR	Uplink (MS, reverse link)	$0 \leq N \leq 239$	$870.0125 + 0.025 \times N$
	Downlink (BS, forward link)	$0 \leq N \leq 239$	$915.0125 + 0.025 \times N$

LTE FDD Channel Number Ranges

The carrier frequency in the uplink and downlink is designated by the E-UTRA Absolute Radio Frequency Channel Number (EARFCN) in the range 0 – 65535. The relation between EARFCN and the carrier frequency in MHz for the downlink is given by the following equation, where FDL_low and NOffs-DL are given in table 5.4.4-1 and NDL is the downlink EARFCN.

$$FDL = FDL_low + 0.1(NDL - NOffs-DL)$$

The relation between EARFCN and the carrier frequency in MHz for the uplink is given by the following equation where FUL_low and NOffs-UL are given in table 5.4.4-1 and NUL is the uplink EARFCN.

$$FUL = FUL_low + 0.1(NUL - NOffs-UL)$$

Band	Downlink		Uplink			
	FDL_low (MHz)	NOffs-DL	Range of NDL	FUL_low (MHz)	NOffs-UL	Range of NUL
1		2110	0	0 - 599	1920	18000 - 18599
2		1930	600	600 - 1199	1850	18600 - 19199
3		1805	1200	1200 - 1949	1710	19200 - 19949
4		2110	1950	1950 - 2399	1710	19950 - 20399
5		869	2400	2400 - 2649	824	20400 - 20649
6		875	2650	2650 - 2749	830	20650 - 20749
7		2620	2750	2750 - 3449	2500	20750 - 20449
8		925	3450	3450 - 3799	880	21450 - 21799
9		1844.9	3800	3800 - 4149	1749.9	21800 - 22149
10		2110	4150	4150 - 4749	1710	22150 - 22749
11		1475.9	4750	4750 - 4949	1427.9	22750 - 22949

Band	Downlink	Uplink				
12	729	5010	5010 - 5179	699	23010	23010 - 23179
13	746	5180	5180 - 5279	777	23180	23180 - 23279
14	758	5280	5280 - 5379	788	23280	23280 - 23379
...						
17	734	5730	5730 - 5849	704	23730	23730 - 23849
18	860	5850	5850 - 5999	815	23850	23850 - 23999
19	875	6000	6000 - 6149	830	24000	24000 - 24149
20	791	6150	6150 - 6449	832	24150	24150 - 24449
21	1495.9	6450	6450 - 6599	1447.9	24450	24450 - 24599
...						
24	1525	7700	7700 - 8039	1626.5	25700	25700 - 26039
25	1930	8040	8040 - 8689	1850	26040	26040 - 26689
26	859	8690	8690 - 9039	814	26690	26690 - 27039
...						

Note: The channel numbers that designate carrier frequencies so close to the operating band edges that the carrier extends beyond the operating band edge shall not be used. This implies that the first 7, 15, 25, 50, 75 and 100 channel numbers at the lower operating band edge and the last 6, 14, 24, 49, 74 and 99 channel numbers at the upper operating band edge shall not be used for channel bandwidths of 1.4, 3, 5, 10, 15 and 20 MHz respectively.

LTE TDD Channel Number Ranges

The carrier frequency in the uplink and downlink is designated by the E-UTRA Absolute Radio Frequency Channel Number (EARFCN) in the range 0 – 65535. The relation between EARFCN and the carrier frequency in MHz for the downlink is given by the following equation, where FDL_low and NOffs-DL are given in table 5.4.4-1 and NDL is the downlink EARFCN.

$$FDL = FDL_low + 0.1(NDL - NOffs-DL)$$

The relation between EARFCN and the carrier frequency in MHz for the uplink is given by the following equation where FUL_low and NOffs-UL are given in table 5.4.4-1 and NUL is the uplink EARFCN.

$$FUL = FUL_low + 0.1(NUL - NOffs-UL)$$

Band	Downlink		Uplink		
	NOffs-DL	FUL_low (MHz)	Range of NDL	NOffs-UL	Range of NUL
33	1900	36000	36000 – 36199	1900	36000 – 36199
34	2010	36200	36200 – 36349	2010	36200 – 36349
35	1850	36350	36350 – 36949	1850	36350 – 36949
36	1930	36950	36950 – 37549	1930	36950 – 37549
37	1910	37550	37550 – 37749	1910	37550 – 37749
38	2570	37750	37750 – 38249	2570	37750 – 38249
39	1880	38250	38250 – 38649	1880	38250 – 38649
40	2300	38650	38650 – 39649	2300	38650 – 39649
41	2496	39650	39650 – 41589	2496	39650 – 41589
42	3400	41590	41590 – 43589	3400	41590 – 43589
43	3600	43590	43590 – 45589	3600	43590 – 45589

Note: The channel numbers that designate carrier frequencies so close to the operating band edges that the carrier extends beyond the operating band edge shall not be used. This implies that the first 7, 15, 25, 50, 75 and 100 channel numbers at the lower operating band edge and the last 6, 14, 24, 49, 74 and 99 channel numbers at the upper operating band edge shall not be used for channel bandwidths of 1.4, 3, 5, 10, 15 and 20 MHz respectively.

TDSCDMA Channel Number Ranges

1.28 Mcps TDD Option

No TX-RX frequency separation is required as Time Division Duplex (TDD) is employed. Each subframe consists of 7 main timeslots where all main timeslots (at least the first one) before the single switching point are allocated DL and all main timeslots (at least the last one) after the single switching point are allocated UL.

The nominal channel spacing is 1.6 MHz, but this can be adjusted to optimise performance in a particular deployment scenario.

The carrier frequency is designated by the UTRA absolute radio frequency channel number (UARFCN). The value of the UARFCN in the IMT2000 band is defined in the general case as follows:

$$N_t = 5 * F \quad 0.0 \text{ MHz} \leq F \leq 3276.6 \text{ MHz}$$

where F is the carrier frequency in MHz

Additional channels applicable to operation in the frequency band defined in sub-clause 5.2(d) are defined via the following UARFCN definition:

$$N_t = 5 * (F - 2150.1 \text{ MHz}) / 2572.5 \text{ MHz} \leq F \leq 2617.5 \text{ MHz}$$

UARFCN

1.28 Mcps TDD Option

The following UARFCN range shall be supported for each band:

Table: UTRA Absolute Radio Frequency Channel Number 1.28 Mcps TDD Option

Frequency Band	Frequency Range	UARFCN Uplink and Downlink transmission
For operation in frequency band as defined in subclause 5.2 (a)	1900–1920 MHz	9504 to 9596
	2010–2025 MHz	10054 to 10121
For operation in frequency band as defined in subclause 5.2 (b)	1850–1910 MHz	9254 to 9546
	1930–1990 MHz	9654 to 9946
For operation in frequency band as defined in subclause 5.2 (c)	1910–1930 MHz	9554 to 9646
For operation in frequency band as defined in subclause 5.2 (d)	2570–2620 MHz	12854 to 13096
For operation in frequency band as defined in subclause 5.2 (e)	2300–2400 MHz	11504 to 11996
For operation in frequency band as defined in subclause 5.2 (f)	1880–1920 MHz	9404 to 9596

Radio Setup

Allows access to the sub-menus for selecting the radio standard and associated radio band. You can also set a frequency reference and offset.

This menu is greyed out when on E6630A. Radio band settings for GSM, cdma2000, and so on -- most of which are not actually supported in E6630A, which has three narrow frequency bands. So band settings are grayed out.

Key Path	Source, Frequency
Initial S/W Revision	A.05.00

Radio Standard

Allows access to the channel band sub-menus to select the desired radio standard. When you have selected the radio standard, you can then set an active channel band. The radio standard and the active

channel band allow you to use channel numbers to set frequency automatically.

Key Path	Source, Frequency, Radio Setup
Remote Command	:SOURce:FREQuency:CHANnels:BAND NONE PGSM EGSM RGSM DCS1800 PCS1900 TGSM810 GSM450 GSM480 GSM700 GSM850 BANDI BANDII BANDIII BANDIV BANDV BANDVI BANDVII BANDVIII BANDIX BANDX BANDXI BANDXII BANDXIII BANDXIV BANDXIX USCELL USPCS JAPAN KOREAN NMT IMT2K UPPER SECOND PAMR400 PAMR800 IMTEXT PCS1DOT9G AWS US2DOT5G PUBLIC LOWER BAND1 BAND2 BAND3 BAND4 BAND5 BAND6 BAND7 BAND8 BAND10 BAND11 BAND12 BAND13 BAND14 BAND17 BAND18 BAND19 BAND20 BAND21 BAND24 BAND25 BAND26 BAND27 BAND28 BAND29 BAND30 BAND31 BAND33 BAND34 BAND35 BAND36 BAND37 BAND38 BAND39 BAND40 BAND41 BAND42 BAND43 BAND44 BANDA BANDB BANDC BANDD BANDE BANDE :SOURce:FREQuency:CHANnels:BAND?
Example	:SOUR:FREQ:CHAN:BAND PGSM
Notes	Set this setting to "NONE" will grey out "Channel" on page 2103 Channel
Initial S/W Revision	A.05.00

None

Selects no radio standard for use. When you have selected the radio standard to NONE, you cannot use channel numbers to set frequency automatically. You will need to set the frequency manually.

Key Path	Source, Frequency, Radio Setup, Radio Standard
Initial S/W Revision	A.05.00

GSM/EDGE

Sets GSM/EDGE as the radio standard for use and accesses the GSM/EDGE specific channel band sub-menus.

Key Path	Source, Frequency, Radio Setup, Radio Standard
Initial S/W Revision	A.05.00

P-GSM

Selects P-GSM as the active channel band.

Key Path	Source, Frequency, Radio Setup, Radio Standard, GSM/EDGE
Example	:SOUR:FREQ:CHAN:BAND PGSM
Initial S/W Revision	A.05.00

E-GSM

Selects E-GSM as the active channel band.

Key Path	Source, Frequency, Radio Setup, Radio Standard, GSM/EDGE
Example	:SOUR:FREQ:CHAN:BAND EGSM
Initial S/W Revision	A.05.00

R-GSM

Selects R-GSM as the active channel band.

Key Path	Source, Frequency, Radio Setup, Radio Standard, GSM/EDGE
Example	:SOUR:FREQ:CHAN:BAND RGSM
Initial S/W Revision	A.05.00

DCS 1800

Selects DCS 1800 as the active channel band.

Key Path	Source, Frequency, Radio Setup, Radio Standard, GSM/EDGE
Example	:SOUR:FREQ:CHAN:BAND DCS1800
Initial S/W Revision	A.05.00

PCS 1900

Selects PCS 1900 as the active channel band.

Key Path	Source, Frequency, Radio Setup, Radio Standard, GSM/EDGE
Example	:SOUR:FREQ:CHAN:BAND PCS1900
Initial S/W Revision	A.05.00

GSM 450

Selects GSM 450 as the active channel band.

Key Path	Source, Frequency, Radio Setup, Radio Standard, GSM/EDGE
Example	:SOUR:FREQ:CHAN:BAND GSM450
Initial S/W Revision	A.05.00

GSM 480

Selects GSM 480 as the active channel band.

Key Path	Source, Frequency, Radio Setup, Radio Standard, GSM/EDGE
Example	:SOUR:FREQ:CHAN:BAND GSM480
Initial S/W Revision	A.05.00

GSM 850

Selects GSM 850 as the active channel band.

Key Path	Source, Frequency, Radio Setup, Radio Standard, GSM/EDGE
Example	:SOUR:FREQ:CHAN:BAND GSM850
Initial S/W Revision	A.05.00

GSM 700

Selects GSM 700 as the active channel band.

Key Path	Source, Frequency, Radio Setup, Radio Standard, GSM/EDGE
Example	:SOUR:FREQ:CHAN:BAND GSM700
Initial S/W Revision	A.05.00

T-GSM 810

Selects T-GSM 810 as the active channel band.

Key Path	Source, Frequency, Radio Setup, Radio Standard, GSM/EDGE
Example	:SOUR:FREQ:CHAN:BAND T-GSM810
Initial S/W Revision	A.05.00

WCDMA

Sets WCDMA as the radio standard for use and accesses the W-CDMA specific channel band sub-menus.

Key Path	Source, Frequency, Radio Setup, Radio Standard
Initial S/W Revision	A.05.00

Band I

Selects Band I as the active channel band.

Key Path	Source, Frequency, Radio Setup, Radio Standard, WCDMA
Example	:SOUR:FREQ:CHAN:BAND BANDI
Initial S/W Revision	A.05.00

Band II

Selects Band II as the active channel band.

Key Path	Source, Frequency, Radio Setup, Radio Standard, WCDMA
Example	:SOUR:FREQ:CHAN:BAND BANDII
Initial S/W Revision	A.05.00

Band III

Selects Band III as the active channel band.

Key Path	Source, Frequency, Radio Setup, Radio Standard, WCDMA
Example	:SOUR:FREQ:CHAN:BAND BANDIII
Initial S/W Revision	A.05.00

Band IV

Selects Band IV as the active channel band.

Key Path	Source, Frequency, Radio Setup, Radio Standard, WCDMA
Example	:SOUR:FREQ:CHAN:BAND BANDIV
Initial S/W Revision	A.05.00

Band V

Selects Band V as the active channel band.

Key Path	Source, Frequency, Radio Setup, Radio Standard, WCDMA
Example	:SOUR:FREQ:CHAN:BAND BANDV
Initial S/W Revision	A.05.00

Band VI

Selects Band VI as the active channel band.

Key Path	Source, Frequency, Radio Setup, Radio Standard, WCDMA
Example	:SOUR:FREQ:CHAN:BAND BANDVI
Initial S/W Revision	A.05.00

Band VII

Selects Band VII as the active channel band.

Key Path	Source, Frequency, Radio Setup, Radio Standard, WCDMA
Example	:SOUR:FREQ:CHAN:BAND BANDVII
Initial S/W Revision	A.05.00

Band VIII

Selects Band VIII as the active channel band.

Key Path	Source, Frequency, Radio Setup, Radio Standard, WCDMA
Example	:SOUR:FREQ:CHAN:BAND BANDVIII
Initial S/W Revision	A.05.00

Band IX

Selects Band IX as the active channel band.

Key Path	Source, Frequency, Radio Setup, Radio Standard, WCDMA
Example	:SOUR:FREQ:CHAN:BAND BANDIX
Initial S/W Revision	A.05.00

Band X

Selects Band X as the active channel band.

Key Path	Source, Frequency, Radio Setup, Radio Standard, WCDMA
Example	:SOUR:FREQ:CHAN:BAND BANDX
Initial S/W Revision	A.05.00

Band XI

Selects Band XI as the active channel band.

Key Path	Source, Frequency, Radio Setup, Radio Standard, WCDMA
Example	:SOUR:FREQ:CHAN:BAND BANDXI
Initial S/W Revision	A.05.00

Band XII

Selects Band XII as the active channel band.

Key Path	Source, Frequency, Radio Setup, Radio Standard, WCDMA
Example	:SOUR:FREQ:CHAN:BAND BANDXII
Initial S/W Revision	A.05.00

Band XIII

Selects band XIII as the active channel band.

Key Path	Source, Frequency, Radio Setup, Radio Standard, WCDMA
Example	:SOUR:FREQ:CHAN:BAND BANDXIII
Initial S/W Revision	A.05.00

Band XIV

Selects Band XIV as the active channel band.

Key Path	Source, Frequency, Radio Setup, Radio Standard, WCDMA
Example	:SOUR:FREQ:CHAN:BAND BANDXIV
Initial S/W Revision	A.05.00

LTE

Sets LTE FDD as the radio standard for use and accesses the LTE FDD specific channel band sub-menus..

Key Path	Source, Frequency, Radio Setup, Radio Standard
Initial S/W Revision	A.09.50

BAND 1

Selects BAND 1 as the band for the current step.

Key Path	Source, Frequency, Radio Setup, Radio Standard, LTE
----------	---

Example	:SOUR:FREQ:CHAN:BAND BAND1
Initial S/W Revision	A.09.50

BAND 2

Selects BAND 2 as the band for the current step.

Key Path	Source, Frequency, Radio Setup, Radio Standard, LTE
Example	:SOUR:FREQ:CHAN:BAND BAND2
Initial S/W Revision	A.09.50

BAND 3

Selects BAND 3 as the band for the current step.

Key Path	Source, Frequency, Radio Setup, Radio Standard, LTE
Example	:SOUR:FREQ:CHAN:BAND BAND3
Initial S/W Revision	A.09.50

BAND 4

Selects BAND 4 as the band for the current step.

Key Path	Source, Frequency, Radio Setup, Radio Standard, LTE
Example	:SOUR:FREQ:CHAN:BAND BAND4
Initial S/W Revision	A.09.50

BAND 5

Selects BAND 5 as the band for the current step.

Key Path	Source, Frequency, Radio Setup, Radio Standard, LTE
Example	:SOUR:FREQ:CHAN:BAND BAND5
Initial S/W Revision	A.09.50

BAND 6

Selects BAND 6 as the band for the current step.

Key Path	Source, Frequency, Radio Setup, Radio Standard, LTE
----------	---

Example	:SOUR:FREQ:CHAN:BAND BAND6
Initial S/W Revision	A.09.50

BAND 7

Selects BAND 7 as the band for the current step.

Key Path	Source, Frequency, Radio Setup, Radio Standard, LTE
Example	:SOUR:FREQ:CHAN:BAND BAND7
Initial S/W Revision	A.09.50

BAND 8

Selects BAND 8 as the band for the current step.

Key Path	Source, Frequency, Radio Setup, Radio Standard, LTE
Example	:SOUR:FREQ:CHAN:BAND BAND8
Initial S/W Revision	A.09.50

BAND 9

Selects BAND 9 as the band for the current step.

Key Path	Source, Frequency, Radio Setup, Radio Standard, LTE
Example	:SOUR:FREQ:CHAN:BAND BAND9
Initial S/W Revision	A.09.50

BAND 10

Selects BAND 10 as the band for the current step.

Key Path	Source, Frequency, Radio Setup, Radio Standard, LTE
Example	:SOUR:FREQ:CHAN:BAND BAND10
Initial S/W Revision	A.09.50

BAND 11

Selects BAND 11 as the band for the current step.

Key Path	Source, Frequency, Radio Setup, Radio Standard, LTE
----------	---

Example	:SOUR:FREQ:CHAN:BAND BAND11
Initial S/W Revision	A.09.50

BAND 12

Selects BAND 12 as the band for the current step.

Key Path	Source, Frequency, Radio Setup, Radio Standard, LTE
Example	:SOUR:FREQ:CHAN:BAND BAND12
Initial S/W Revision	A.09.50

BAND 13

Selects BAND 13 as the band for the current step.

Key Path	Source, Frequency, Radio Setup, Radio Standard, LTE
Example	:SOUR:FREQ:CHAN:BAND BAND13
Initial S/W Revision	A.09.50

BAND 14

Selects BAND 14 as the band for the current step.

Key Path	Source, Frequency, Radio Setup, Radio Standard, LTE
Example	:SOUR:FREQ:CHAN:BAND BAND14
Initial S/W Revision	A.09.50

BAND 17

Selects BAND 17 as the band for the current step.

Key Path	Source, Frequency, Radio Setup, Radio Standard, LTE
Example	:SOUR:FREQ:CHAN:BAND BAND17
Initial S/W Revision	A.09.50

BAND 18

Selects BAND 18 as the band for the current step.

Key Path	Source, Frequency, Radio Setup, Radio Standard, LTE
----------	---

Example	:SOUR:FREQ:CHAN:BAND BAND18
Initial S/W Revision	A.09.50

BAND 19

Selects BAND 19 as the band for the current step.

Key Path	Source, Frequency, Radio Setup, Radio Standard, LTE
Example	:SOUR:FREQ:CHAN:BAND BAND19
Initial S/W Revision	A.09.50

BAND 20

Selects BAND 20 as the band for the current step.

Key Path	Source, Frequency, Radio Setup, Radio Standard, LTE
Example	:SOUR:FREQ:CHAN:BAND BAND20
Initial S/W Revision	A.09.50

BAND 21

Selects BAND 21 as the band for the current step.

Key Path	Source, Frequency, Radio Setup, Radio Standard, LTE
Example	:SOUR:FREQ:CHAN:BAND BAND21
Initial S/W Revision	A.09.50

BAND 24

Selects BAND 24 as the band for the current step.

Key Path	Source, Frequency, Radio Setup, Radio Standard, LTE
Example	:SOUR:FREQ:CHAN:BAND BAND24
Initial S/W Revision	A.09.50

BAND 25

Selects BAND 25 as the band for the current step.

Key Path	Source, Frequency, Radio Setup, Radio Standard, LTE
----------	---

Example	:SOUR:FREQ:CHAN:BAND BAND25
Initial S/W Revision	A.09.50

BAND 26

Selects BAND 26 as the band for the current step.

Key Path	Source, Frequency, Radio Setup, Radio Standard, LTE
Example	:SOUR:FREQ:CHAN:BAND BAND26
Initial S/W Revision	A.12.53

BAND 27

Selects BAND 27 as the band for the current step.

Key Path	Source, Frequency, Radio Setup, Radio Standard, LTE
Example	:SOUR:FREQ:CHAN:BAND BAND27
Initial S/W Revision	A.14.00

BAND 28

Selects BAND 28 as the band for the current step.

Key Path	Source, Frequency, Radio Setup, Radio Standard, LTE
Example	:SOUR:FREQ:CHAN:BAND BAND28
Initial S/W Revision	A.14.00

BAND 31

Selects BAND 31 as the band for the current step.

Key Path	Source, Frequency, Radio Setup, Radio Standard, LTE
Example	:SOUR:FREQ:CHAN:BAND BAND31
Initial S/W Revision	A.14.00

LTE TDD

Sets LTE TDD as the radio standard for use and accesses the LTE TDD specific channel band sub-menus..

Key Path	Source, Frequency, Radio Setup, Radio Standard
Initial S/W Revision	A.11.50

BAND 33

Selects BAND 33 as the band for the current step.

Key Path	Source, Frequency, Radio Setup, Radio Standard, LTE TDD
Example	:SOUR:FREQ:CHAN:BAND BAND33
Initial S/W Revision	A.11.50

BAND 34

Selects BAND 34 as the band for the current step.

Key Path	Source, Frequency, Radio Setup, Radio Standard, LTE TDD
Example	:SOUR:FREQ:CHAN:BAND BAND34
Initial S/W Revision	A.11.50

BAND 35

Selects BAND 35 as the band for the current step.

Key Path	Source, Frequency, Radio Setup, Radio Standard, LTE TDD
Example	:SOUR:FREQ:CHAN:BAND BAND35
Initial S/W Revision	A.11.50

BAND 36

Selects BAND 36 as the band for the current step.

Key Path	Source, Frequency, Radio Setup, Radio Standard, LTE TDD
Example	:SOUR:FREQ:CHAN:BAND BAND36
Initial S/W Revision	A.11.50

BAND 37

Selects BAND 37 as the band for the current step.

Key Path	Source, Frequency, Radio Setup, Radio Standard, LTE TDD
Example	:SOUR:FREQ:CHAN:BAND BAND37
Initial S/W Revision	A.11.50

BAND 38

Selects BAND 38 as the band for the current step.

Key Path	Source, Frequency, Radio Setup, Radio Standard, LTE TDD
Example	:SOUR:FREQ:CHAN:BAND BAND38
Initial S/W Revision	A.11.50

BAND 39

Selects BAND 39 as the band for the current step.

Key Path	Source, Frequency, Radio Setup, Radio Standard, LTE TDD
Example	:SOUR:FREQ:CHAN:BAND BAND39
Initial S/W Revision	A.11.50

BAND 40

Selects BAND 40 as the band for the current step.

Key Path	Source, Frequency, Radio Setup, Radio Standard, LTE TDD
Example	:SOUR:FREQ:CHAN:BAND BAND40
Initial S/W Revision	A.11.50

BAND 41

Selects BAND 41 as the band for the current step.

Key Path	Source, Frequency, Radio Setup, Radio Standard, LTE TDD
Example	:SOUR:FREQ:CHAN:BAND BAND41
Initial S/W Revision	A.11.50

BAND 42

Selects BAND 42 as the band for the current step.

Key Path	Source, Frequency, Radio Setup, Radio Standard, LTE TDD
Example	:SOUR:FREQ:CHAN:BAND BAND42
Initial S/W Revision	A.11.50

BAND 43

Selects BAND 43 as the band for the current step.

Key Path	Source, Frequency, Radio Setup, Radio Standard, LTE TDD
Example	:SOUR:FREQ:CHAN:BAND BAND43
Initial S/W Revision	A.11.50

BAND 44

Selects BAND 44 as the band for the current step.

Key Path	Source, Frequency, Radio Setup, Radio Standard, LTE TDD
Example	:SOUR:FREQ:CHAN:BAND BAND44
Initial S/W Revision	A.14.00

TDSCDMA

Sets TDSCDMA as the radio standard for use and accesses the TDSCDMA specific channel band sub-menus..

Key Path	Source, Frequency, Radio Setup, Radio Standard
Initial S/W Revision	A.11.50

BAND A

Selects BAND A as the band for the current step.

Key Path	Source, Frequency, Radio Setup, Radio Standard, TDSCDMA
Example	:SOUR:FREQ:CHAN:BAND BANDA
Initial S/W Revision	A.11.50

BAND B

Selects BAND B as the band for the current step.

Key Path	Source, Frequency, Radio Setup, Radio Standard, TDSCDMA
Example	:SOUR:FREQ:CHAN:BAND BANDB
Initial S/W Revision	A.11.50

BAND C

Selects BAND C as the band for the current step.

Key Path	Source, Frequency, Radio Setup, Radio Standard, TDSCDMA
Example	:SOUR:FREQ:CHAN:BAND BANDC
Initial S/W Revision	A.11.50

BAND D

Selects BAND D as the band for the current step.

Key Path	Source, Frequency, Radio Setup, Radio Standard, TDSCDMA
Example	:SOUR:FREQ:CHAN:BAND BANDD
Initial S/W Revision	A.11.50

BAND E

Selects BAND E as the band for the current step.

Key Path	Source, Frequency, Radio Setup, Radio Standard, TDSCDMA
Example	:SOUR:FREQ:CHAN:BAND BANDE
Initial S/W Revision	A.11.50

BAND F

Selects BAND F as the band for the current step.

Key Path	Source, Frequency, Radio Setup, Radio Standard, TDSCDMA
Example	:SOUR:FREQ:CHAN:BAND BANDF
Initial S/W Revision	A.11.50

Radio Band Link

Allows you to specify the channel band type as either uplink or downlink link direction. This value is used in conjunction with the channel band and channel number to determine the absolute frequency output by the source. When set to "Uplink", the source will calculate the uplink frequency using an uplink formula together with the selected channel band and channel number. When set to "Downlink", the source will calculate the downlink frequency using a downlink formula together with the selected channel band and channel number.

Key Path	Source, Frequency, Radio Setup
Remote Command	:SOURce:RADio:BAND:LINK DOWN UP :SOURce:RADio:BAND:LINK?

Example	:SOUR:RAD:BAND:LINK UP
Preset	DOWN
Range	DOWN UP
Backwards Compatibility SCPI	:SOURce:RADio:DEVIce BTS MS
	:SOURce:RADio:DEVIce?
Backwards Compatibility Notes	BTS maps to the Downlink frequency MS maps to the Uplink frequency
Initial S/W Revision	A.05.00

Set Reference Frequency

This key allows you to set the frequency reference. Pressing this key turns the frequency reference state to ON, sets the reference frequency value to the current frequency, maintains this frequency at the RF output, and sets the displayed frequency to 0.00 Hz. All subsequent frequencies entered under Source>Frequency>Frequency are interpreted as being relative to this reference frequency.

When you use a frequency reference, the signal generator outputs a frequency that is set relative to the reference frequency by the value entered under Source>Frequency>Frequency as follows:

Output frequency = reference frequency - entered frequency

Where:

reference frequency equals the original RF frequency entered under Source>Frequency>Frequency and set as the reference frequency

entered frequency equals a new value entered under Source>Frequency>Frequency

In addition, the displayed frequency value will be the same as the value entered under Source>Frequency>Frequency.

NOTE

If Freq Reference is set to ON with a reference value set, entering a value under Source>Frequency>Frequency and pressing Set Frequency Reference will add that value to the existing Freq Reference value.

If you wish to change the reference frequency value to the new value entered under Source>Frequency>Frequency, first you must set Freq Reference to OFF and then press Set Frequency Reference.

Key Path	Source, Frequency
Remote Command	:SOURce:FREQuency:REFerence:SET
Example	:SOUR:FREQ:REF:SET
Dependencies	This setting is unavailable, and is grayed out when the List Sequencer is turned ON.
Initial S/W Revision	A.05.00

Freq Reference

This key allows you to toggle the state of the frequency reference. When the frequency reference state is ON, an annunciator is displayed on the main source view to indicate this state to the user.

When you use a frequency reference, the signal generator outputs a frequency that is set relative to the reference frequency by the value entered under Source>Frequency>Frequency as follows:

Output frequency = reference frequency + entered frequency

Where:

reference frequency equals the original RF frequency entered under Source>Frequency>Frequency and set as the reference frequency

entered frequency equals a new value entered under Source>Frequency>Frequency

For more information on Reference Frequency refer to ["Set Reference Frequency" on page 2127](#)

Key Path	Source, Frequency
Remote Command	:SOURce:FREQuency:REFerence <freq> :SOURce:FREQuency:REFerence? :SOURce:FREQuency:REFerence:STATe OFF ON 0 1 :SOURce:FREQuency:REFerence:STATe?
Example	:SOUR:FREQ:REF 0.00 Hz :SOUR:FREQ:REF:STATe ON
Dependencies	This setting is unavailable, and is grayed out when the List Sequencer is turned ON.
Couplings	The frequency reference state is coupled to the frequency reference set immediate action. When the reference set immediate action key is pressed, or the SCPI command issued, it turns the frequency reference state ON.
Preset	0.00 Hz OFF
Min	0.00 Hz
Max	Hardware Dependant: Option 503 = 3.6 GHz Option 504 = 3.8 GHz Option 506 = 6.00 GHz
Initial S/W Revision	A.05.00

Freq Offset

Allows you to specify the frequency offset value. When the frequency offset state is ON, an annunciator is displayed on the main source view to indicate this state to the user.

When the frequency offset is set to zero (0) and you set a new offset value, the displayed frequency value will change as follows and the RF output frequency will not change:

Displayed value = output frequency + offset value

Where:

output frequency equals the original frequency entered under Source>Frequency>Frequency

offset value equals the value entered under Source>Frequency>Freq Offset

When the frequency offset is set to a value other than zero (0) and you enter a new frequency value under Source>Frequency>Frequency, the displayed frequency will be the same as the value entered and the RF output frequency will be equal to the value entered minus the offset value as follows:

Output frequency = entered frequency – offset frequency

Displayed frequency = output frequency + offset frequency

Displayed frequency = entered frequency

Where:

entered frequency equals the frequency entered under Source>Frequency>Frequency

offset frequency equals the value previously entered and set under Source>Frequency>Freq Offset

Key Path	Source, Frequency
Remote Command	:SOURce:FREQuency:OFFSet <freq> :SOURce:FREQuency:OFFSet?
Example	:SOUR:FREQ:OFFS 0 Hz
Dependencies	This setting is unavailable, and is grayed out when the List Sequencer is turned ON.
Preset	0 Hz
Min	-100.00 GHz
Max	100.00 GHz
Initial S/W Revision	A.05.00

Modulation Setup

Allows access to the menus for setting up the available modulation types: "ARB" on page 2143, "AM" on page 2164, "FM" on page 2165, and "PM" on page 2167.

Key Path	Source
Initial S/W Revision	A.05.00

ARB

Allows you access to the ARB sub-menus.

Key Path	Source, Modulation Setup
Initial S/W Revision	A.05.00

ARB

Allows you to toggle the state of the ARB function. When the ARB is On, a “MOD” annunciator is displayed in the system settings panel. When the ARB is turned Off, the MOD annunciator is cleared

Key Path	Source, Modulation Setup, ARB
Remote Command	:SOURce:RADio:ARB[:STATe] ON OFF 1 0 :SOURce:RADio:ARB[:STATe]?
Example	:SOUR:RAD:ARB OFF :SOUR:RAD:ARB?
Notes	If the ARB is ON, a user then loads or deletes another file to ARB memory, the playing waveform segment may not keep phase continuity during the ARB memory operation. The waveform will be replayed after the ARB operation is finished.
Dependencies	This setting is for independent mode and has no effect on 3.3.8 list sequencer mode. Setting "Sequencer" on page 2168 Sequencer to On will put source enter list sequencer mode, and even if ARB state is On, the ARB file will not be played. Setting "Sequencer" on page 2168 Sequencer to Off will make source leave list sequencer mode, and this setting will take effect immediately. The ARB can only be turned on when there is a waveform file selected for playback. On the GUI if no waveform is selected, this key is grayed out. If you send the SCPI command to turn the ARB on with no waveform selected for playback, the ARB state remains OFF and an error is generated. "- When you try to recall a certain set of states in which the selected waveform is not in ARB memory and the ARB state is On, errors are reported
Preset	Off
Range	On Off
Initial S/W Revision	A.05.00

Select Waveform

Allows you to access to the waveform selection sub-menus.

Pressing this key changes the central view area to show the Waveform File Selection view.

Key Path	Source, Modulation Setup, ARB
Initial S/W Revision	A.05.00

Select Waveform

Allows you to select a waveform sequence or segment for the dual ARB to play.

NOTE: Selecting a waveform file does not result in automatic adjustments to burst timing (to compensate for the presence or absence of a Multiport Adapter); that adjustment occurs only when a waveform is loaded to ARB memory. See "Load Segment to ARB Memory" for more information about this adjustment.

Key Path	Source, Modulation Setup, ARB, Select Waveform
Remote Command	:SOURce:RADio:ARB:WAVeform <string> :SOURce:RADio:ARB:WAVeform?
Example	:SOUR:RAD:ARB:WAV "test_waveform.bin"
Notes	<p>If intended waveform is not in the memory yet, then issuing this command by SCPI will invoke ARB loading operation first, which involves a delay of unpredictable length. So this command should be followed by the query *OPC?, which holds off subsequent commands until the loading operation is complete.</p> <p><string> - specifies the name of the waveform segment or waveform sequence to be played by the ARB.</p> <p>When in Sequence Analyzer mode, and Include Source is Yes, if the you attempt to play a waveform sequence but not all the required waveform segments are in the ARB playback memory, the application will reject the loading operation with an error is generated .</p> <p>When Include Source is No, if you attempt to play a waveform sequence but not all the required waveform segments are contained in the ARB playback memory, the application will attempt to load the required segments from either the default directory of the current directory. If the ARB memory does not have enough space for all the waveform segments to be loaded, an error is generated and none of the waveform segments is loaded.</p> <p>If the ARB is ON, and you attempt to play a waveform sequence but not all the waveform segments within the sequence could be found to be loaded into ARB memory, an error is generated. The selected waveform keeps the previous value and ARB state remains On.</p> <p>If you specify a waveform segment over SCPI but the waveform segment is not present within ARB playback memory and cannot be found for auto loading within the current directory or the default directory, an error is generated and the file selection remains unchanged.</p> <p>If you select a waveform for playback and the waveform requires a license that is not installed on the instrument, an error is generated. error is generated.</p> <p>If the ARB is ON and you load a file to ARB memory or delete a file from ARB memory, the playing waveform segment may not keep phase continuity during the ARB memory operation. The waveform will be replayed after the ARB operation is finished.</p>
Initial S/W Revision	A.05.00

Segments on Hard Disk

Allows you access to the sub-menus for loading waveform segments from the hard disk into ARB memory. The default directory is: D: varb.

Pressing this key changes the current view to the Waveform Management View.

Key Path	Source, Modulation Setup, ARB, Select Waveform
Initial S/W Revision	A.05.00

Load Segment To ARB Memory

Allows you to load the selected file into ARB memory. On the front panel you select the file for loading to the ARB memory by highlighting the desired file in the list. Using the SCPI command, you specify the file

name on the HDD.

“NVWFM” (none-volatile storage) MSUS (Mass Storage Unit Specifier) is supported in the memory subsystem because the ARB memory cannot be accessed directly. Therefore, files must be downloaded to the instrument hard disk and then loaded into the ARB memory. “NVWFM” MSUS will be mapped to the default directory D: VARB. The SCPI command supports using either “NVWFM” MSUS or specifying a full path. For more information, see Memory Subsystem (Remote Command Only).

If a file of the same name already exists within ARB memory, it is overwritten. If you wish to load two segments of the same name, you must rename one of the segments before loading it into ARB memory. To rename a segment, you can either use Windows File Explorer, or the :MMEMORY:COPY command.

NOTE: When a waveform file is loaded to ARB memory, burst timing adjustments are made automatically, based on whether or not a Multiport Adapter is connected to the test set and powered on. If the connection/power status of the Multiport Adapter is changed after a waveform file has been loaded, it needs to be loaded again.

Key Path	Source, Modulation Setup, ARB, Select Waveform, Segments on Hard Disk
Remote Command	:SOURCE:RADio:ARB:LOAD <string>
Example	:SOUR:RAD:ARB:LOAD "D: VARB\testwaveform.bin" or :SOUR:RAD:ARB:LOAD "NVWFM:testwaveform.bin"
Notes	<p>Because loading the file involves a delay of unpredictable length, this command should be followed by the query *OPC?, which holds off subsequent commands until the loading operating is complete.</p> <p><string> - specifies the path name of the file to load from the HDD into ARB memory. It could be a <full path + filename>, or <"NVWFM" MSUS + colon + filename>.</p> <p>When in Sequence Analyzer mode, and Include Source is Yes, an attempt to load a file to ARB memory will be rejected with an error.</p> <p>When Include Source is No and if there is insufficient free ARB memory to load the selected waveform, an error is generated. .</p> <p>If you specify a file over SCPI, but the file is not at the specified location, an error is generated.</p> <p>If you try to load a waveform file but the file contains less than 500 IQ samples, an error is generated.</p> <p>If you try to load a Signal Studio waveform "*.wfm" which contains invalid waveform header, an error is generated.</p> <p>If the ARB is ON when you load a file to ARB memory or delete a file from ARB memory, the playing waveform segment may not keep phase continuity during the ARB memory operation. The waveform will be replayed after the ARB operation is finished.</p> <p>ARB can be loaded into ARB memory even required licenses do not present on the instrument. In this case, a GUI only warning message -800, "Operation complete; Loaded <filename> successfully, but no license <required licenses> installed". User can install required licenses according to <required licenses> string to license it, or multi-pack license it.</p>
Initial S/W Revision	A.05.00

Load All To ARB Memory

Allows you to load all the segment files within the currently selected directory into ARB memory. If a file of the same name already exists within ARB memory, it is overwritten. If you wish to load two segments of the

same name, you must rename one of the segments before loading it into ARB memory. To rename a segment, you can either use Windows File Explorer, or the :MEMory:COpy command.

NOTE: When a waveform file is loaded to ARB memory, burst timing adjustments are made automatically, based on whether or not a Multiport Adapter is connected to the test set and powered on. If the connection/power status of the Multiport Adapter is changed after a waveform file has been loaded, it needs to be loaded again.

Key Path	Source, Modulation Setup, ARB, Select Waveform, Segments on Hard Disk
Remote Command	:SOURce:RADio:ARB:LOAD:ALL <string>
Example	:SOUR:RAD:ARB:LOAD:ALL "D: varb"
Notes	<p><string> - specifies the directory on the HDD to load the files into ARB memory from.</p> <p>When in Sequence Analyzer mode, and Include Source is Yes, an attempt to load all files from a directory to ARB memory is rejected with an error.</p> <p>When Include Source is No and there is insufficient free ARB memory to load all the waveforms, when the ARB memory is full, the copy ceases, and an error is generated.</p> <p>If you specify a directory over SCPI, but the directory does not exist, an error is generated.</p> <p>If the ARB is ON, a user then loads or deletes file to ARB memory, the playing waveform segment may not keep phase continuity during the ARB memory operation. The waveform will be replayed after the ARB operation is finished.</p>
Initial S/W Revision	A.05.00

Change Directory...

Allows you to change the currently selected directory on the hard disk. Pressing this key opens a standard windows change directory dialog allowing you to select the new directory of interest.

The current directory is used for manually loading waveform segments into ARB memory for playback, and as a search location for waveform segments that are required to be loaded into ARB memory for playback of a waveform sequence or a list sequence.

Key Path	Source, Modulation Setup, ARB, Select Waveform, Segments on Hard Disk
Notes	No remote command, SCPI front panel only.
Initial S/W Revision	A.05.00

Default Directory...

Allows you to change the default directory. It is used as a search location for waveform segments that are required to be loaded into ARB memory for playback of a waveform sequence, and as a search location for selecting waveforms using SCPI.

Key Path	Source, Modulation Setup, ARB, Select Waveform, Segments on Hard Disk
Remote Command	:SOURce:RADio:ARB:DEFault:DIRectory <string> :SOURce:RADio:ARB: DEFault:DIRectory?
Example	:SOUR:RAD:ARB:DEF:DIR "D:\ArbFiles"

	:SOUR:RAD:ARB:DEF:DIR?
State Saved	Persistent, survives a power cycle and a preset but not saved in the instrument state
Initial S/W Revision	A.05.00

Segments in ARB Memory

Allows you access to the sub-menus for managing the files within ARB memory.

Key Path	Source, Modulation Setup, ARB, Select Waveform
Initial S/W Revision	A.05.00

Delete Segment From ARB Mem

Allows you to remove a segment from ARB playback memory.

Key Path	Source, Modulation Setup, ARB, Select Waveform, Segments in ARB Memory
Remote Command	:SOURce:RADio:ARB:DELeTe <string>
Example	:SOUR:RAD:ARB:DEL "testwaveform.bin"
Notes	<p><string> - specifies the waveform to be deleted from the ARB playback memory.</p> <p>When in Sequence Analyzer mode and Include Source is Yes, an attempt to delete a file from ARB memory is rejected with an error.</p> <p>When Include Source is No and you specify a file that does not exist within ARB memory, an error is generated.</p> <p>It is possible to delete files from within the ARB memory when the ARB is ON. However, if you attempt to delete the file that is currently playing an error is generated.</p> <p>It is possible to delete a file from within the ARB memory when the sequencer state is ON and the file is not being used by the List Sequencer. If you attempt to delete a file which is being used by the list sequencer, an error is generated.</p> <p>When sequencer state is On, even if ARB state is On, the selected waveform will not be played. In this case, if the selected waveform is not used in List Sequence, it can be deleted and the ARB state is turned Off.</p> <p>If the ARB is ON and you load a file to ARB memory or delete a file from ARB memory, the playing waveform segment may not keep phase continuity during the ARB memory operation. The waveform will be replayed after the ARB operation is finished.</p>
Initial S/W Revision	A.05.00

Delete All From ARB Memory

Allows you to remove all segments from ARB playback memory.

Key Path	Source, Modulation Setup, ARB, Select Waveform, Segments in ARB Memory
----------	--

Remote Command	:SOURce:RADio:ARB:DELeTe:ALL
Example	:SOUR:RAD:ARB:DELeTe:ALL
Notes	<p>When in Sequence Analyzer mode and Include Source is Yes, an attempt to delete all files from ARB memory is rejected with an error.</p> <p>When Include Source is No and you attempt to delete all files from ARB memory when the ARB is currently playing a file, all files except the one playing are deleted and an error is generated.</p> <p>If you attempt to delete all files from ARB memory when there are waveform files used in "List Sequencer" on page 2168 and "Sequencer" on page 2168 state is ON, all files except the files currently being used in list sequencer are deleted, and an error is generated.</p> <p>If the ARB is ON and you load a file to ARB memory or delete a file from ARB memory, the playing waveform segment may not keep phase continuity during the ARB memory operation. The waveform will be replayed after the ARB operation is finished.</p>
Initial S/W Revision	A.05.00

ARB Setup

Allows access to the ARB setup sub-menus.

Key Path	Source, Modulation Setup, ARB
Initial S/W Revision	A.05.00

Sample Rate

Allows you to set the ARB waveform playback sample rate.

Key Path	Source, Modulation Setup, ARB, ARB Setup
Remote Command	:SOURce:RADio:ARB:SCLock:RATE <freq> :SOURce:RADio:ARB:SCLock:RATE?
Example	:SOUR:RAD:ARB:SCL:RATE 48.00 MHz
Notes	If there is a sample rate specified in the header of the waveform file, changing that sample rate is not recommended, as it may cause problems with burst timing.
Dependencies	When a new waveform is selected for playback the settings contained within the associated waveform header file are applied to the ARB. The sample rate is one of the values stored within the header file. If the newly selected waveform file has an associated header file, the sample rate is updated with the value from the header file. The sample rate will remain unchanged if the newly selected waveform does not have an associated header file.
Preset	125.00 MHz
Min	1.00 kHz
Max	125.00 MHz
Initial S/W Revision	A.05.00

Run-Time Scaling

Allows you to adjust the run-time scaling value. The run-time scaling value is applied in real-time while the waveform is playing.

Key Path	Source, Modulation Setup, ARB, ARB Setup
Remote Command	:SOURce:RADio:ARB:RSCaling <real> :SOURce:RADio:ARB:RSCaling?
Example	:SOUR:RAD:ARB:RSC 100.00
Notes	This setting cannot be set in E6640A/M9420A. Grey out on menu and the value is fixed at 70.00%.
Dependencies	When a new waveform is selected for playback the settings contained within the associated waveform header file are applied to the ARB. The run-time scaling is one of the values stored within the header file. If the newly selected waveform file has an associated header file, the run-time scaling is updated with the value from the header file. The run-time scaling will remain unchanged if the newly selected waveform does not have an associated header file.
Preset	70.00 %
Min	1.00 %
Max	100.00 %
Initial S/W Revision	A.05.00

Baseband Freq Offset

Allows you to adjust the value by which the baseband frequency is offset relative to the carrier.

Key Path	Source, Modulation Setup, ARB, ARB Setup
Remote Command	:SOURce:RADio:ARB:BASEband:FREQuency:OFFSet <freq> :SOURce:RADio:ARB:BASEband:FREQuency:OFFSet?
Example	:SOUR:RAD:ARB:BAS:FREQ:OFFS 0.00 Hz
Dependencies	When a new waveform is selected for playback the settings contained within the associated waveform header file are applied to the ARB. The baseband frequency offset is one of the values stored within the header file. If the newly selected waveform file has an associated header file, the baseband frequency offset is updated with the value from the header file. The baseband frequency offset will remain unchanged if the newly selected waveform does not have an associated header file.
Preset	0.00 Hz
Min	-50.00 MHz
Max	50.00 MHz
Initial S/W Revision	A.05.00

Edit RMS

Allows you to edit or calculate current RMS of selected waveform.

Key Path	Source, Modulation Setup, ARB, ARB Setup
Initial S/W Revision	A.14.50

Current RMS

Allows you to directly specify current RMS value used to playback currently selected waveform. Please note incorrect RMS value may cause inaccurate power output in E6640A/M9420A that is sensitive to RMS value.

This setting is also updated by RMS in waveform header or updated when invoking RMS calculation operation.

This setting can be saved to the header of currently selected waveform by invoking ["Save Setup To Header" on page 2164](#) "Save Setup To Header".

Key Path	Source, Modulation Setup, ARB, ARB Setup, Edit RMS
Remote Command	:SOURce:RADio:ARB:RMS <float> :SOURce:RADio:ARB:RMS?
Example	:SOUR:RAD:ARB:HEAD:RMS 0.7 :SOUR:RAD:ARB:HEAD:RMS?
Notes	Valid range is 0 to 1.414, values outside the range will be clipped to the closest boundary. Note this value does not affect "List Sequencer" on page 2168 Source List Sequencer that always uses RMS value resides in each ARB header. If want this value to take effect in list sequencer, use "Save Setup To Header" on page 2164 "Save Setup to Header" to save current RMS value to header first, then play the ARB in source list sequencer.
Dependencies	When a new waveform is selected for playback, this setting is updated by the RMS value defined in associated waveform header file. If selected waveform has no associated header file or header file does not specify RMS value, then instrument will try to calculate out one automatically. Calculating RMS can also update this setting.
Preset	0
Range	0 ~ 1.414
Initial S/W Revision	A.14.50

RMS Calculation Mode

Allows you to specify the mode to calculate the current RMS.

Key Path	Source, Modulation Setup, ARB, ARB Setup, Edit RMS
Remote Command	:SOURce:RADio:ARB:RMS:CALCulation:MODE AUTO M1 M2 M3 M4 :SOURce:RADio:ARB:RMS:CALCulation:MODE?
Example	:SOUR:RAD:ARB:RMS:CALC:MODE AUTO
Notes	If no waveform is selected, or selected waveform is waveform sequence, the key will grey out.

Preset	AUTO
Range	AUTO M1 M2 M3 M4
Initial S/W Revision	A.14.50

Auto

RMS will be calculated based on the whole sample range of current selected waveform.

Key Path	Source, Modulation Setup, ARB, ARB Setup, Edit RMS, Calculate RMS, RMS Calculation Mode
Example	:SOUR:RAD:ARB:RMS:CALC:MODE AUTO
Initial S/W Revision	A.14.50

Marker 1

Selects marker 1 to designate sample range used for RMS calculation.

Key Path	Source, Modulation Setup, ARB, ARB Setup, Edit RMS, Calculate RMS, RMS Calculation Mode , Marker
Example	:SOUR:RAD:ARB:RMS:CALC:MODE M1
Initial S/W Revision	A.14.50

Marker 2

Selects marker 2 to designate sample range used for RMS calculation.

Key Path	Source, Modulation Setup, ARB, ARB Setup, Edit RMS, Calculate RMS, RMS Calculation Mode , Marker
Example	:SOUR:RAD:ARB:RMS:CALC:MODE M2
Initial S/W Revision	A.14.50

Marker 3

Selects marker 3 to designate sample range used for RMS calculation.

Key Path	Source, Modulation Setup, ARB, ARB Setup, Edit RMS, Calculate RMS, RMS Calculation Mode , Marker
Example	:SOUR:RAD:ARB:RMS:CALC:MODE M3
Initial S/W Revision	A.14.50

Marker 4

Selects marker 4 to designate sample range used for RMS calculation.

Key Path	Source, Modulation Setup, ARB, ARB Setup, Edit RMS, Calculate RMS, RMS Calculation Mode , Marker
Example	:SOUR:RAD:ARB:RMS:CALC:MODE M4
Initial S/W Revision	A.14.50

Calculate RMS

Allows you to calculate current RMS based on mode selected. This will update "[Current RMS](#)" on page 2137 Current RMS setting.

Key Path	Source, Modulation Setup, ARB, ARB Setup, Edit RMS, Calculate RMS
Remote Command	:SOURce:RADio:ARB:RMS:CALCulate
Example	:SOUR:RAD:ARB:RMS:CALC
Notes	<p>If no waveform is selected, invoking this operation will get error “-221 Setting conflict; No waveform is selected for RMS operation”.</p> <p>If no waveform is selected, or selected waveform is waveform sequence, the key will grey out.</p> <p>If selected waveform does not contain marker data, but "RMS Calculation Mode" on page 2137 “RMS Calculation Mode” is set to marker, under this circumstance, invoking calculation operation will get error “-221 Setting conflict; There is no marker for currently selected waveform, auto RMS calculation mode is used instead”, and "RMS Calculation Mode" on page 2137 “RMS Calculation Mode” will be coupled to “Auto” mode automatically.</p> <p>RMS calculation does not suit for waveform sequence. If selected waveform is waveform sequence file, invoking this operation will get error “-221 Setting conflict; RMS calculation does not apply to waveform sequence”. But users can still edit current RMS as play parameter, and can save current RMS to waveform sequence header for later use.</p>
Initial S/W Revision	A.14.50

Use Header RMS

Allows you to quickly set RMS in ARB header to "[Current RMS](#)" on page 2137 Current RMS setting.

Key Path	Source, Modulation Setup, ARB, ARB Setup, Edit RMS,
Notes	<p>No remote command, front panel only.</p> <p>If no waveform is selected, the key will grey out.</p> <p>If no waveform is selected, invoking this operation will get error “-221 Setting conflict; No waveform is selected for RMS operation”.</p>
Initial S/W Revision	A.14.50

Trigger Type

Allows access to the trigger type sub-menus. The setting for trigger type determines the behavior of the waveform when it plays.

Key Path	Source, Modulation Setup, ARB
Remote Command	:SOURce:RADio:ARB:TRIGger:TYPE CONTInuous SINGLE SADVance :SOURce:RADio:ARB:TRIGger:TYPE?
Example	:SOUR:RAD:ARB:TRIG:TYPE CONT :SOUR:RAD:ARB:TRIG:TYPE?
Notes	Gated trigger type will be implemented at a later release
Preset	CONTInuous
Range	Continuous Single Seg Adv
Initial S/W Revision	A.05.00

Continuous

Sets the active trigger type to Continuous. If Continuous is already selected as the active trigger type, pressing this key allows access to the continuous trigger type setup menu. In Continuous trigger mode, the waveform repeats continuously.

Key Path	Source, Modulation Setup, ARB, Trigger Type
Remote Command	:SOURce:RADio:ARB:TRIGger:TYPE:CONTInuous[:TYPE] FREE TRIGger RESet :SOURce:RADio:ARB:TRIGger:TYPE:CONTInuous[:TYPE]?
Example	:SOUR:RAD:ARB:TRIG:TYPE:CONT FREE
Preset	FREE
Range	Free Run Trigger + Run Reset + Run
Initial S/W Revision	A.05.00

Free Run

Selects Free Run as the trigger response for the continuous trigger type. Free Run sets the waveform generator to play a waveform sequence or segment continuously, without waiting for a trigger. In this mode, the waveform generator does not respond to triggers.

Key Path	Source, Modulation Setup, ARB, Trigger Type, Continuous
Example	:SOUR:RAD:ARB:TRIG:TYPE:CONT FREE
Initial S/W Revision	A.05.00

Trigger + Run

Sets Trigger and Run as the trigger response for the continuous trigger type. Trigger and Run sets the waveform generator to play a waveform sequence or segment continuously when the first trigger is received, and to ignore any subsequent triggers.

Key Path	Source, Modulation Setup, ARB, Trigger Type, Continuous
Example	:SOUR:RAD:ARB:TRIG:TYPE:CONT TRIG
Initial S/W Revision	A.05.00

Reset + Run

Sets Reset and Run as the trigger response for the continuous trigger type. Reset and Run sets the waveform generator to play a waveform sequence or segment continuously when the first trigger is received. Subsequent triggers reset the waveform sequence or segment to the start, and then play it continuously.

Key Path	Source, Modulation Setup, ARB, Trigger Type, Continuous
Example	:SOUR:RAD:ARB:TRIG:TYPE:CONT RES
Initial S/W Revision	A.05.00

Single

Sets the active trigger type to Single. If Single is already selected as the active trigger type, pressing this key allows access to the single trigger type setup menu. In Single trigger mode, the waveform plays once.

Key Path	Source, Modulation Setup, ARB, Trigger Type
Remote Command	:SOURce:RADio:ARB:RETRigger ON OFF IMMediate :SOURce:RADio:ARB:RETRigger?
Example	:SOUR:RAD:ARB:RETR OFF
Notes	ON: Buffered Trigger OFF: No Retrigger Immediate: Restart on Trigger This is defined as an enumerated SCPI command, with ON OFF being considered as enumerated types rather than Boolean. This means the query will return OFF instead of 0, and ON instead of 1.
Preset	ON
Range	No Retrigger Buffered Trigger Restart on Trigger
Initial S/W Revision	A.05.00

No Retrigger

Selects No Retrigger as the trigger response for single trigger type. No Retrigger sets the waveform generator to play a waveform sequence or segment once when a trigger is received. Any triggers then

received during playback are ignored.

Key Path	Source, Modulation Setup, ARB, Trigger Type, Single
Example	:SOUR:RAD:ARB:RETR OFF
Initial S/W Revision	A.05.00

Buffered Trigger

Selects Buffered Trigger as the trigger response for single trigger type. Buffered Trigger sets the waveform generator to play a waveform sequence or segment once when a trigger is received. If a trigger is received during playback, the waveform generator plays the sequence or segment to the end, then plays the sequence or segment once more.

Key Path	Source, Modulation Setup, ARB, Trigger Type, Single
Example	:SOUR:RAD:ARB:RETR ON
Initial S/W Revision	A.05.00

Restart on Trigger

Selects Restart on Trigger as the trigger response for single trigger type. Restart on Trigger sets the waveform generator to play a waveform sequence or segment once when a trigger is received. If a trigger is received during playback, the waveform generator resets and plays the sequence or segment from the start.

Key Path	Source, Modulation Setup, ARB, Trigger Type, Single
Example	:SOUR:RAD:ARB:RETR IMM
Initial S/W Revision	A.05.00

Segment Advance

Sets the active trigger type to Segment Advance. If Segment Advance is already selected as the active trigger type, pressing this key allows access to the segment advance trigger type setup menu.

Segment Advance triggering allows you to control the playback of waveform segments within a waveform sequence. When a trigger is received the ARB advances to the next waveform segment within the waveform sequence. This type of triggering ignores the repetition count for the waveform segment within the waveform sequence. For example, if a waveform segment has a repetition count of 10 and you select single segment advance triggering mode, the waveform segment will only play once.

Segment Advance triggering can also be used for waveform segments only. In this situation the same waveform segment is played again when a trigger is received.

Key Path	Source, Modulation Setup, ARB, Trigger Type
Remote Command	:SOURce:RADio:ARB:TRIGger:TYPE:SADVance[:TYPE] SINGLE CONTInuous

	:SOURce:RADio:ARB:TRIGger:TYPE:SADVance[:TYPE]?
Example	:SOUR:RAD:ARB:TRIG:TYPE:SADV SING
Preset	CONTInuous
Range	Single Continuous
Initial S/W Revision	A.05.00

Single

Selects Single as the trigger response for Segment Advance trigger type. With single selected, once a trigger is received a segment is played once. If a trigger is received during playback of a segment, the segment plays to completion and the next segment is played once.

Key Path	Source, Modulation Setup, ARB, Trigger Type, Segment Advance
Example	:SOUR:RAD:ARB:TRIG:TYPE:SADV SING
Initial S/W Revision	A.05.00

Continuous

Selects Continuous as the trigger response for Segment Advance trigger type. With continuous selected, once a trigger is received a segment is played continuously. When subsequent triggers are received, the currently playing segment plays to completion and then the next segment is played continuously.

Key Path	Source, Modulation Setup, ARB, Trigger Type, Segment Advance
Example	:SOUR:RAD:ARB:TRIG:TYPE:SADV CONT
Initial S/W Revision	A.05.00

ARB

Allows you access to the ARB sub-menus.

Key Path	Source, Modulation Setup
Initial S/W Revision	A.05.00

Trigger Source

The trigger source setting determines how the source receives the trigger that starts the waveform playing. Therefore, this key is grayed out if the trigger type is free run, since free run triggers immediately with no trigger source required.

Key Path	Source, Modulation Setup, ARB
Remote Command	:SOURce:RADio:ARB:TRIGger[:SOURce] KEY BUS EXTernal2

	:SOURce:RADio:ARB:TRIGger[:SOURce]?
Example	:SOUR:RAD:ARB:TRIGger KEY
Dependencies	This key is grayed out if the current trigger type is Continuous, Free Run.
Preset	EXTernal2
Range	Trigger Key Bus External 2
Initial S/W Revision	A.05.00

Trigger Key

Sets the current trigger source to the front panel Trigger key. When Trigger Key is selected, the waveform is triggered when you press the front panel Trigger key.

Key Path	Source, Modulation Setup, ARB, Trigger Source
Example	:SOUR:RAD:ARB:TRIGger KEY
Initial S/W Revision	A.05.00

Bus

Sets the current trigger source to Bus. Selecting Bus trigger source enables triggering over GPIB, LAN, or USB using the :SOURce:RADio:ARB:TRIGger:INITiate command.

Key Path	Source, Modulation Setup, ARB, Trigger Source
Example	:SOUR:RAD:ARB:TRIGger BUS
Initial S/W Revision	A.05.00

External 2

Sets the current trigger source to External 2. Selecting External 2 enables triggering a waveform by an externally applied signal.

Key Path	Source, Modulation Setup, ARB, Trigger Source
Example	:SOUR:RAD:ARB:TRIGger EXT2
Notes	Note: When on E6640A, trigger 2 is a bi-directional trigger port. So when trigger 2 has been configured as OUTPUT type, choosing External 2 as the input trigger for the current step will generate error.
Initial S/W Revision	A.05.00

External Trigger Delay

This key allows you to toggle the state and value of external trigger delay. The value you enter sets a delay time between when an external trigger is received and when it is applied to the waveform. This is key is

active only if you select external trigger as trigger source.

Key Path	Source, Modulation Setup, ARB, Trigger Source
Remote Command	:SOURce:RADio:ARB:TRIGger[:SOURce]:EXTernal:DELay <time> :SOURce:RADio:ARB:TRIGger[:SOURce]:EXTernal:DELay? SOURce:RADio:ARB:TRIGger[:SOURce]:EXTernal:DELay:STATe OFF ON 0 1 :SOURce:RADio:ARB:TRIGger[:SOURce]:EXTernal:DELay:STATe?
Example	:SOUR:RAD:ARB:TRIG:EXT:DEL 100ns :SOUR:RAD:ARB:TRIG:EXT:DEL? :SOUR:RAD:ARB:TRIG:EXT:DEL:STAT ON :SOUR:RAD:ARB:TRIG:EXT:DEL:STAT?
Notes	External trigger delay time set by users will be rounded to the nearest integer multiple of the resolution.
Dependencies	This setting is unavailable and is grayed out when the Trigger Source is not set to external trigger.
Preset	1 ms OFF
Min	0 s
Max	8.589934588 s (Note: This value comes from $4\text{ns} * (2^{31} - 1) = 8589934588\text{ ns}$)
Initial S/W Revision	A.14.50

Trigger Initiate

Used to initiate an immediate trigger event if the trigger source is set to Trigger Key.

Key Path	Source, Modulation Setup, ARB
Notes	No remote command, SCPI front panel only.
Initial S/W Revision	A.05.00

Waveform Sequences

Allows access to the waveform sequence sub-menus. Pressing this key changes the central view area to display the Waveform Sequence List view.

Key Path	Source, Modulation Setup, ARB
Notes	No remote command, SCPI front panel only.
Initial S/W Revision	A.05.00

Build New Sequence

Allows access to the sub-menus for creating a new waveform sequence. Pressing this key changes the central view area to display the Waveform Sequence Creation and Editing view.

Key Path	Source, Modulation Setup, ARB, Waveform Sequences
Notes	No remote command, SCPI front panel only.
Initial S/W Revision	A.05.00

Current Segment

Specifies the selected sequence segment that will be affected by the menu functions.

Key Path	Source, Modulation Setup , ARB, Waveform Sequences, Build New Sequence
Notes	No remote command, SCPI front panel only. This key is grayed out and unavailable if the sequence is currently empty.
Initial S/W Revision	A.05.00

Insert New Waveform

Allows you access to the sub-menu for inserting a new waveform segment or sequence. Pressing this key also changes the central display to show the Waveform File Selection View.

Key Path	Source, Modulation Setup, ARB, Waveform Sequences, Build New Sequence
Notes	No remote command, SCPI front panel only. Waveform segment name string length upper limit is 128 chars. Please do NOT insert waveform which name string exceeds 128 chars.
Initial S/W Revision	A.05.00

Insert Waveform

Inserts the currently highlighted waveform to the end of the waveform sequence. Pressing this key also returns you to the menus for creating or editing a sequence, and returns the central view to the sequence creation view.

Key Path	Source, Modulation Setup, ARB, Waveform Sequences, Build New Sequence, Insert New Waveform
Notes	No remote command, SCPI front panel only. Waveform segment name string length upper limit is 128 chars. Please do NOT insert waveform which name string exceeds 128 chars.
Initial S/W Revision	A.05.00

Segments on Hard Disk

Allows you access to the sub-menus for loading waveform segments from the hard disk into ARB memory. The default directory is: D: varb.

Pressing this key changes the current view to the Waveform Management View.

Key Path	Source, Modulation Setup, ARB, Select Waveform
Initial S/W Revision	A.05.00

Load Segment To ARB Memory

Allows you to load the selected file into ARB memory. On the front panel you select the file for loading to the ARB memory by highlighting the desired file in the list. Using the SCPI command, you specify the file name on the HDD.

“NVWFM” (none-volatile storage) MSUS (Mass Storage Unit Specifier) is supported in the memory subsystem because the ARB memory cannot be accessed directly. Therefore, files must be downloaded to the instrument hard disk and then loaded into the ARB memory. “NVWFM” MSUS will be mapped to the default directory D: VARB. The SCPI command supports using either “NVWFM” MSUS or specifying a full path. For more information, see Memory Subsystem (Remote Command Only).

If a file of the same name already exists within ARB memory, it is overwritten. If you wish to load two segments of the same name, you must rename one of the segments before loading it into ARB memory. To rename a segment, you can either use Windows File Explorer, or the :MMEMory:COPI command.

NOTE: When a waveform file is loaded to ARB memory, burst timing adjustments are made automatically, based on whether or not a Multiport Adapter is connected to the test set and powered on. If the connection/power status of the Multiport Adapter is changed after a waveform file has been loaded, it needs to be loaded again.

Key Path	Source, Modulation Setup, ARB, Select Waveform, Segments on Hard Disk
Remote Command	:SOURce:RADio:ARB:LOAD <string>
Example	:SOUR:RAD:ARB:LOAD "D: VARB\testwaveform.bin" or :SOUR:RAD:ARB:LOAD "NVWFM:testwaveform.bin"
Notes	<p>Because loading the file involves a delay of unpredictable length, this command should be followed by the query *OPC?, which holds off subsequent commands until the loading operating is complete.</p> <p><string> – specifies the path name of the file to load from the HDD into ARB memory. It could be a <full path + filename>, or <“NVWFM” MSUS + colon + filename>.</p> <p>When in Sequence Analyzer mode, and Include Source is Yes, an attempt to load a file to ARB memory will be rejected with an error.</p> <p>When Include Source is No and if there is insufficient free ARB memory to load the selected waveform, an error is generated. .</p> <p>If you specify a file over SCPI, but the file is not at the specified location, an error is generated.</p> <p>If you try to load a waveform file but the file contains less than 500 IQ samples, an error is generated.</p> <p>If you try to load a Signal Studio waveform “*.wfm” which contains invalid waveform header, an error is generated.</p>

If the ARB is ON when you load a file to ARB memory or delete a file from ARB memory, the playing waveform segment may not keep phase continuity during the ARB memory operation. The waveform will be replayed after the ARB operation is finished.

ARB can be loaded into ARB memory even if required licenses do not present on the instrument. In this case, a GUI only warning message -800, "Operation complete; Loaded <filename> successfully, but no license <required licenses> installed". User can install required licenses according to <required licenses> string to license it, or multi-pack license it.

Initial S/W Revision A.05.00

Load All To ARB Memory

Allows you to load all the segment files within the currently selected directory into ARB memory. If a file of the same name already exists within ARB memory, it is overwritten. If you wish to load two segments of the same name, you must rename one of the segments before loading it into ARB memory. To rename a segment, you can either use Windows File Explorer, or the :MEMory:COpy command.

NOTE: When a waveform file is loaded to ARB memory, burst timing adjustments are made automatically, based on whether or not a Multiport Adapter is connected to the test set and powered on. If the connection/power status of the Multiport Adapter is changed after a waveform file has been loaded, it needs to be loaded again.

Key Path Source, Modulation Setup, ARB, Select Waveform, Segments on Hard Disk

Remote Command :SOURce:RADio:ARB:LOAD:ALL <string>

Example :SOUR:RAD:ARB:LOAD:ALL "D: varb"

Notes <string> - specifies the directory on the HDD to load the files into ARB memory from.

When in Sequence Analyzer mode, and Include Source is Yes, an attempt to load all files from a directory to ARB memory is rejected with an error.

When Include Source is No and there is insufficient free ARB memory to load all the waveforms, when the ARB memory is full, the copy ceases, and an error is generated.

If you specify a directory over SCPI, but the directory does not exist, an error is generated.

If the ARB is ON, a user then loads or deletes file to ARB memory, the playing waveform segment may not keep phase continuity during the ARB memory operation. The waveform will be replayed after the ARB operation is finished.

Initial S/W Revision A.05.00

Change Directory...

Allows you to change the currently selected directory on the hard disk. Pressing this key opens a standard windows change directory dialog allowing you to select the new directory of interest.

The current directory is used for manually loading waveform segments into ARB memory for playback, and as a search location for waveform segments that are required to be loaded into ARB memory for playback of a waveform sequence or a list sequence.

Key Path	Source, Modulation Setup, ARB, Select Waveform, Segments on Hard Disk
Notes	No remote command, SCPI front panel only.
Initial S/W Revision	A.05.00

Default Directory...

Allows you to change the default directory. It is used as a search location for waveform segments that are required to be loaded into ARB memory for playback of a waveform sequence, and as a search location for selecting waveforms using SCPI.

Key Path	Source, Modulation Setup, ARB, Select Waveform, Segments on Hard Disk
Remote Command	:SOURce:RADio:ARB:DEFault:DIRectory <string> :SOURce:RADio:ARB: DEFault:DIRectory?
Example	:SOUR:RAD:ARB:DEF:DIR "D:\ArbFiles" :SOUR:RAD:ARB:DEF:DIR?
State Saved	Persistent, survives a power cycle and a preset but not saved in the instrument state
Initial S/W Revision	A.05.00

Segments in ARB Memory

Allows you access to the sub-menus for managing the files within ARB memory.

Key Path	Source, Modulation Setup, ARB, Select Waveform
Initial S/W Revision	A.05.00

Delete Segment From ARB Mem

Allows you to remove a segment from ARB playback memory.

Key Path	Source, Modulation Setup, ARB, Select Waveform, Segments in ARB Memory
Remote Command	:SOURce:RADio:ARB:DELete <string>
Example	:SOUR:RAD:ARB:DEL "testwaveform.bin"
Notes	<string> - specifies the waveform to be deleted from the ARB playback memory. When in Sequence Analyzer mode and Include Source is Yes, an attempt to delete a file from ARB memory is rejected with an error. When Include Source is No and you specify a file that does not exist within ARB memory, an error is generated. It is possible to delete files from within the ARB memory when the ARB is ON. However, if you attempt to delete the file that is currently playing an error is generated. It is possible to delete a file from within the ARB memory when the sequencer state is ON and the file is not being used by the List Sequencer. If you attempt to delete a file which is being used by the list

sequencer, an error is generated.

When sequencer state is On, even if ARB state is On, the selected waveform will not be played. In this case, if the selected waveform is not used in List Sequence, it can be deleted and the ARB state is turned Off.

If the ARB is ON and you load a file to ARB memory or delete a file from ARB memory, the playing waveform segment may not keep phase continuity during the ARB memory operation. The waveform will be replayed after the ARB operation is finished.

Initial S/W Revision	A.05.00
----------------------	---------

Delete All From ARB Memory

Allows you to remove all segments from ARB playback memory.

Key Path	Source, Modulation Setup, ARB, Select Waveform, Segments in ARB Memory
Remote Command	:SOURce:RADio:ARB:DELeTe:ALL
Example	:SOUR:RAD:ARB:DELeTe:ALL
Notes	<p>When in Sequence Analyzer mode and Include Source is Yes, an attempt to delete all files from ARB memory is rejected with an error.</p> <p>When Include Source is No and you attempt to delete all files from ARB memory when the ARB is currently playing a file, all files except the one playing are deleted and an error is generated.</p> <p>If you attempt to delete all files from ARB memory when there are waveform files used in "List Sequencer" on page 2168 and "Sequencer" on page 2168 state is ON, all files except the files currently being used in list sequencer are deleted, and an error is generated.</p> <p>If the ARB is ON and you load a file to ARB memory or delete a file from ARB memory, the playing waveform segment may not keep phase continuity during the ARB memory operation. The waveform will be replayed after the ARB operation is finished.</p>
Initial S/W Revision	A.05.00

Edit Selected Waveform

Allows access to the sub-menus for editing the details of the currently selected waveform segment.

Key Path	Source, Modulation Setup, ARB, Waveform Sequences, Build New Sequence
Notes	No remote command, front panel only.
Initial S/W Revision	A.05.00

Repetitions

Allows you to specify the number of times the currently selected waveform is played within the sequence.

Key Path	Source, Modulation Setup, ARB, Waveform Sequences, Build New Sequence, Edit Selected Waveform
----------	---

Notes	No remote command, SCPI front panel only.
Preset	1
Min	1
Max	65535
Initial S/W Revision	A.05.00

Marker 1

Allows you to enable or disable marker 1 for the currently selected waveform. For a waveform sequence, you can enable and disable markers on a per-segment basis, allowing you to output markers from some waveform segments within the sequence, but not for others.

Key Path	Source, Modulation Setup, ARB, Waveform Sequences, Build New Sequence, Edit Selected Waveform
Notes	No remote command, front panel only.
Preset	Enabled
Range	Enabled Disabled
Initial S/W Revision	A.05.00

Marker 2

Allows you to enable or disable marker 2 for the currently selected waveform. For a waveform sequence, you can enable and disable markers on a per-segment basis, allowing you to output markers from some waveform segments within the sequence, but not for others.

Key Path	Source, Modulation Setup, ARB, Waveform Sequences, Build New Sequence, Edit Selected Waveform
Notes	No remote command, front panel only.
Preset	Enabled
Range	Enabled Disabled
Initial S/W Revision	A.05.00

Marker 3

Allows you to enable or disable marker 3 for the currently selected waveform. For a waveform sequence, you can enable and disable markers on a per-segment basis, allowing you to output markers from some waveform segments within the sequence, but not for others.

Key Path	Source, Modulation Setup, ARB, Waveform Sequences, Build New Sequence, Edit Selected Waveform
----------	---

Notes	No remote command, front panel only.
Preset	Enabled
Range	Enabled Disabled
Initial S/W Revision	A.05.00

Marker 4

Allows you to enable or disable marker 4 for the currently selected waveform. For a waveform sequence, you can enable and disable markers on a per-segment basis, allowing you to output markers from some waveform segments within the sequence, but not for others.

Key Path	Source, Modulation Setup, ARB, Waveform Sequences, Build New Sequence, Edit Selected Waveform
Notes	No remote command, front panel only.
Preset	Enabled
Range	Enabled Disabled
Initial S/W Revision	A.05.00

Delete Segment

Allows you to delete the selected segment from the waveform sequence.

Key Path	Source, Modulation Setup, ARB, Waveform Sequences, Build New Sequence
Notes	No remote command, front panel only.
Initial S/W Revision	A.05.00

Save Sequence...

Pressing this key displays the “Save As” dialog. The sequence name is passed to the save as dialog to use as the filename for saving, and the directory the save as dialog will open into is the default waveform directory.

Key Path	Source, Modulation Setup, ARB, Waveform Sequences, Build New Sequence
Initial S/W Revision	A.05.00

Edit Selected Sequence

Allows access to the sub-menus for editing the sequence currently selected within the Waveform Sequence List view. Pressing this key changes the central view area to display the Waveform Sequence Creation and Editing view.

Key Path	Source, Modulation Setup, ARB, Waveform Sequences
Notes	No remote command, front panel only.
Initial S/W Revision	A.05.00

Current Directory...

Allows you to change the currently selected directory on the hard disk. Pressing this key opens a standard windows change directory dialog and allows you to select the new directory of interest.

Key Path	Source, Modulation Setup, ARB, Waveform Sequences
Notes	No remote command, front panel only.
Initial S/W Revision	A.05.00

Waveform Utilities

Allows you access to the waveform utilities sub-menus.

Key Path	Source, Modulation Setup, ARB
Initial S/W Revision	A.05.00

Multi-Pack Licenses

Allows you access to the Multi - Pack License sub-menus. Pressing this key also changes the central view area to display the Multi -Pack License Management view.

On modular instrument like E6630A or E6640A, multi-pack license operations are only allowed on the default module, i.e. “Left” module for E6630A or “TRX1” module for E6640A.

Key Path	Source, Modulation Setup, ARB, Waveform Utilities
Dependencies	This key is only available if there is at least one Multi-pack license installed on the instrument.
Initial S/W Revision	A.05.00

Add Waveform

Pressing this key accesses the Add Waveform sub-menu. It also changes the central display area to display the Multi-Pack License Waveform Add view.

Key Path	Source, Modulation Setup, ARB, Waveform Utilities, Multi-Pack Licenses
Dependencies	This key is only available if there is at least one slot available within at least one multi-pack license.
Initial S/W Revision	A.05.00

Add Waveform

Allows you to add the currently selected waveform segment to a multi-pack license. The new waveform is added to the next available slot regardless of which slot was selected on the Multi-Pack License Management view.

Key Path	Source, Modulation Setup, ARB, Waveform Utilities, Multi-Pack Licenses, Add Waveform
Remote Command	:SYSTem:LKEY:WAVeform:ADD <string> or :SYSTem:LICense[:FPACK]:WAVeform:ADD <string>
Example	SYST:LKEY:WAV:ADD "mywaveform.wfm" or SYST:LIC:WAV:ADD "mywaveform.wfm"
Notes	The second SCPI :SYSTem:LICense[:FPACK]:WAVeform:ADD is provided to be consistent with the style of Keysight signal sources. You can use either one of them. Since adding a waveform segment to a Multi-Pack license causes the license slot to enter the trial period of only 48 hours, pressing this key causes a confirmation dialog to be displayed to ensure you do want to add the waveform segment to the Multi-Pack. If you attempt to license a waveform that is already licensed using another slot an error is generated. .
Dependencies	This key is only available if the currently selected file is a secure waveform requiring a license, and there is at least one slot available within at least one multi-pack license. If the waveform highlighted is a secure waveform, but is already licensed, this key will be unavailable.
Initial S/W Revision	A.05.00

Segments on Hard Disk

Allows you access to the sub-menus for loading waveform segments from the hard disk into ARB memory. The default directory is: D: varb.

Pressing this key changes the current view to the Waveform Management View.

Key Path	Source, Modulation Setup, ARB, Select Waveform
Initial S/W Revision	A.05.00

Load Segment To ARB Memory

Allows you to load the selected file into ARB memory. On the front panel you select the file for loading to the ARB memory by highlighting the desired file in the list. Using the SCPI command, you specify the file name on the HDD.

"NVWFM" (none-volatile storage) MSUS (Mass Storage Unit Specifier) is supported in the memory subsystem because the ARB memory cannot be accessed directly. Therefore, files must be downloaded to the instrument hard disk and then loaded into the ARB memory. "NVWFM" MSUS will be mapped to the

default directory D: VARB. The SCPI command supports using either “NVWFM” MSUS or specifying a full path. For more information, see Memory Subsystem (Remote Command Only).

If a file of the same name already exists within ARB memory, it is overwritten. If you wish to load two segments of the same name, you must rename one of the segments before loading it into ARB memory. To rename a segment, you can either use Windows File Explorer, or the :MMEMory:COPY command.

NOTE: When a waveform file is loaded to ARB memory, burst timing adjustments are made automatically, based on whether or not a Multiport Adapter is connected to the test set and powered on. If the connection/power status of the Multiport Adapter is changed after a waveform file has been loaded, it needs to be loaded again.

Key Path	Source, Modulation Setup, ARB, Select Waveform, Segments on Hard Disk
Remote Command	:SOURce:RADio:ARB:LOAD <string>
Example	:SOUR:RAD:ARB:LOAD “D: VARB\testwaveform.bin” or :SOUR:RAD:ARB:LOAD “NVWFM:testwaveform.bin”
Notes	<p>Because loading the file involves a delay of unpredictable length, this command should be followed by the query *OPC?, which holds off subsequent commands until the loading operating is complete.</p> <p><string> – specifies the path name of the file to load from the HDD into ARB memory. It could be a <full path + filename>, or <“NVWFM” MSUS + colon + filename>.</p> <p>When in Sequence Analyzer mode, and Include Source is Yes, an attempt to load a file to ARB memory will be rejected with an error.</p> <p>When Include Source is Noand if there is insufficient free ARB memory to load the selected waveform, an error is generated. .</p> <p>If you specify a file over SCPI, but the file is not at the specified location, an error is generated.</p> <p>If you try to load a waveform file but the file contains less than 500 IQ sampes, an error is generated.</p> <p>If you try to load a Signal Studio waveform “*.wfm” which contains invalid waveform header, an error is generated.</p> <p>If the ARB is ON when you load afile to ARB memory or delete a file from ARB memory, the playing waveform segment may not keep phase continuity during the ARB memory operation. The waveform will be replayed after the ARB operation is finished.</p> <p>ARB can be loaded into ARB memory even required licenses do not present on the instrument. In this case, a GUI only warning message -800, “Operation complete; Loaded <filename> successfully, but no license <required licenses> installed”. User can install required licenses according to <required licenses> string to license it, or multi-pack license it.</p>
Initial S/W Revision	A.05.00

Load All To ARB Memory

Allows you to load all the segment files within the currently selected directory into ARB memory. If a file of the same name already exists within ARB memory, it is overwritten. If you wish to load two segments of the same name, you must rename one of the segments before loading it into ARB memory. To rename a segment, you can either use Windows File Explorer, or the :MEMory:COPY command.

NOTE: When a waveform file is loaded to ARB memory, burst timing adjustments are made automatically, based on whether or not a Multiport Adapter is connected to the test set and powered on. If the

connection/power status of the Multiport Adapter is changed after a waveform file has been loaded, it needs to be loaded again.

Key Path	Source, Modulation Setup, ARB, Select Waveform, Segments on Hard Disk
Remote Command	:SOURce:RADio:ARB:LOAD:ALL <string>
Example	:SOUR:RAD:ARB:LOAD:ALL "D: varb"
Notes	<p><string> - specifies the directory on the HDD to load the files into ARB memory from.</p> <p>When in Sequence Analyzer mode, and Include Source is Yes, an attempt to load all files from a directory to ARB memory is rejected with an error.</p> <p>When Include Source is No and there is insufficient free ARB memory to load all the waveforms, when the ARB memory is full, the copy ceases, and an error is generated.</p> <p>If you specify a directory over SCPI, but the directory does not exist, an error is generated.</p> <p>If the ARB is ON, a user then loads or deletes file to ARB memory, the playing waveform segment may not keep phase continuity during the ARB memory operation. The waveform will be replayed after the ARB operation is finished.</p>
Initial S/W Revision	A.05.00

Change Directory...

Allows you to change the currently selected directory on the hard disk. Pressing this key opens a standard windows change directory dialog allowing you to select the new directory of interest.

The current directory is used for manually loading waveform segments into ARB memory for playback, and as a search location for waveform segments that are required to be loaded into ARB memory for playback of a waveform sequence or a list sequence.

Key Path	Source, Modulation Setup, ARB, Select Waveform, Segments on Hard Disk
Notes	No remote command, SCPIfront panel only.
Initial S/W Revision	A.05.00

Default Directory...

Allows you to change the default directory. It is used as a search location for waveform segments that are required to be loaded into ARB memory for playback of a waveform sequence, and as a search location for selecting waveforms using SCPI.

Key Path	Source, Modulation Setup, ARB, Select Waveform, Segments on Hard Disk
Remote Command	:SOURce:RADio:ARB:DEFault:DIRectory <string> :SOURce:RADio:ARB: DEFault:DIRectory?
Example	:SOUR:RAD:ARB:DEF:DIR "D:\ArbFiles" :SOUR:RAD:ARB:DEF:DIR?
State Saved	Persistent, survives a power cycle and a preset but not saved in the instrument state
Initial S/W Revision	A.05.00

Replace Waveform

Pressing this key accesses the Replace Waveform submenu. It also changes the central display area to display the Multi-Pack License Waveform Add view.

Key Path	Source, Modulation Setup, ARB, Waveform Utilities, Multi-Pack Licenses
Dependencies	This key is only available if the currently selected slot is in the trial state.
Initial S/W Revision	A.05.00

Replace Waveform

Allows you to replace the waveform in the currently selected slot with the waveform currently selected in the Multi-Pack License Waveform Add view.

Key Path	Source, Modulation Setup, ARB, Waveform Utilities, Multi-Pack Licenses, Replace Waveform
Remote Command	:SYSTem:LKEY:WAVeform:REPLace <int>, <string> or :SYSTem:LICense[:FPACK]:WAVeform:REPLace <int>, <string>
Example	SYST:LKEY:WAV:REPL 1, "myotherwaveform.wfm" or :SYST:LIC:WAV:REPL 1, "myotherwaveform.wfm"
Notes	The second SCPI :SYSTem:LICense[:FPACK]:WAVeform:REPLace is provided to be consistent with the style of Keysight signal sources. You can use either one of them. If you attempt to license a waveform that is already licensed using another slot an error is generated. Waveform slot number <int> is positive. If you attempt to input a slot number less than or equals 0, an error is generated.
Initial S/W Revision	A.05.00

Clear Waveform from Slot

Allows you to clear the waveform from the selected slot.

Key Path	Source, Modulation Setup, ARB, Waveform Utilities, Multi-Pack Licenses
Remote Command	:SYSTem:LKEY:WAVeform:CLEar <int> or :SYSTem:LICense[:FPACK]:WAVeform:CLEar <int>
Example	SYST:LKEY:WAV:CLE 1 or :SYST:LIC:WAV:CLE 1
Notes	The second SCPI :SYSTem:LICense[:FPACK]:WAVeform:CLEar is provided to be consistent with the style of Keysight signal sources. You can use either one of them. Waveform slot number <int> is positive. If you attempt to input a slot number less than or equals 0, an error is generated.

error is generated.

Dependencies	This key is only available if the currently selected slot is in the trial state.
Initial S/W Revision	A.05.00

Lock Waveform in Slot

If the selected slot is in the trial state or the lock required state, the waveform that occupies the slot is locked and permanently licensed.

Key Path	Source, Modulation Setup, ARB, Waveform Utilities, Multi-Pack Licenses
----------	--

Remote Command	:SYSTem:LKEY:WAVeform:LOCK <int> or :SYSTem:LICense[:FPACK]:WAVeform:LOCK <int>
----------------	---

Example	SYST:LKEY:WAV:LOCK 1 or SYST:LIC:WAV:LOCK 1
---------	---

Notes	The second SCPI :SYSTem:LICense[:FPACK]:WAVeform:LOCK is provided to be consistent with the style of Keysight signal sources. You can use either one of them. Waveform slot number <int> is positive. If you attempt to input a slot number less than or equals 0, an error is generated.
-------	--

Dependencies	This key is only available if the currently selected slot is in the trial state or the lock required state.
Initial S/W Revision	A.05.00

Marker Utilities

Allows access to the marker utilities sub-menus.

Key Path	Source, Modulation Setup, ARB
Initial S/W Revision	A.05.00

Marker Polarity

Allows access to the marker polarity sub-menu, which allows you to specify the polarity for the four markers. For a positive polarity, the marker signal is high during the marker points. For a negative marker polarity, the marker signal is high during the period of no marker points.

Key Path	Source, Modulation Setup, ARB, Marker Utilities
Initial S/W Revision	A.05.00

Mkr 1 Polarity

Allows you to set the polarity of marker 1.

Key Path	Source, Modulation Setup, ARB, Marker Utilities, Marker Polarity
Remote Command	:SOURce:RADio:ARB:MPOLarity:MARKer1 POSitive NEGative :SOURce:RADio:ARB:MPOLarity:MARKer1?
Example	:SOUR:RAD:ARB:MPOL:MARK1 NEG
Dependencies	When a new waveform is selected for playback the settings contained within the associated waveform header file are applied to the ARB. The marker polarity is one of the values stored within the header file. If the newly selected waveform file has an associated header file, the marker polarity is updated with the value from the header file. The marker polarity will remain unchanged if the newly selected waveform does not have an associated header file.
Preset	Pos
Range	Neg Pos
Initial S/W Revision	A.05.00

Mkr 2 Polarity

Allows you to set the polarity of marker 2.

Key Path	Source, Modulation Setup, ARB, Marker Utilities, Marker Polarity
Remote Command	:SOURce:RADio:ARB:MPOLarity:MARKer2 POSitive NEGative :SOURce:RADio:ARB:MPOLarity:MARKer2?
Example	:SOUR:RAD:ARB:MPOL:MARK2 NEG
Dependencies	When a new waveform is selected for playback the settings contained within the associated waveform header file are applied to the ARB. The marker polarity is one of the values stored within the header file. If the newly selected waveform file has an associated header file, the marker polarity is updated with the value from the header file. The marker polarity will remain unchanged if the newly selected waveform does not have an associated header file.
Preset	Pos
Range	Neg Pos
Initial S/W Revision	A.05.00

Mkr 3 Polarity

Allows you to set the polarity of marker 3.

Key Path	Source, Modulation Setup, ARB, Marker Utilities, Marker Polarity
Remote Command	:SOURce:RADio:ARB:MPOLarity:MARKer3 POSitive NEGative :SOURce:RADio:ARB:MPOLarity:MARKer3?
Example	:SOUR:RAD:ARB:MPOL:MARK3 NEG
Dependencies	When a new waveform is selected for playback the settings contained within the associated

	waveform header file are applied to the ARB. The marker polarity is one of the values stored within the header file. If the newly selected waveform file has an associated header file, the marker polarity is updated with the value from the header file. The marker polarity will remain unchanged if the newly selected waveform does not have an associated header file.
Preset	Pos
Range	Neg Pos
Initial S/W Revision	A.05.00

Mkr 4 Polarity

Allows you to set the polarity of marker 4.

Key Path	Source, Modulation Setup, ARB, Marker Utilities, Marker Polarity
Remote Command	:SOURce:RADio:ARB:MPOLarity:MARKer4 POSitive NEGative :SOURce:RADio:ARB:MPOLarity:MARKer4?
Example	:SOUR:RAD:ARB:MPOL:MARK4 NEG
Dependencies	When a new waveform is selected for playback the settings contained within the associated waveform header file are applied to the ARB. The marker polarity is one of the values stored within the header file. If the newly selected waveform file has an associated header file, the marker polarity is updated with the value from the header file. The marker polarity will remain unchanged if the newly selected waveform does not have an associated header file.
Preset	Pos
Range	Neg Pos
Initial S/W Revision	A.05.00

Marker Routing

Allows access to the marker routing sub-menus, which allow you to specify where the marker events are routed. It should be noted that the markers can also be routed to Trigger 1 Out and Trigger 2 Out, however this must be set up using the menus accessed by pressing the “Trigger” hard key.

Key Path	Source, Modulation Setup, ARB, Marker Utilities
Initial S/W Revision	A.05.00

Pulse/RF Blank

Allows you to select which marker is used for the pulse/RF blanking function. The pulse/RF blanking function blanks the RF when the marker signal goes low. The marker polarity determines when the marker signal is high. For a positive polarity, this is during the marker points. For a negative polarity, this is when there are no marker points.

Marker points should be set before using this function. Enabling this function without setting maker points may create a continuous low or high signal, dependant on the marker polarity. This causes either no RF output, or a continuous RF output.

Key Path	Source, Modulation Setup, ARB, Marker Utilities, Marker Routing
Remote Command	:SOURce:RADio:ARB:MDEStination:PULSe NONE M1 M2 M3 M4 :SOURce:RADio:ARB:MDEStination:PULSe?
Example	:SOUR:RAD:ARB:MDES:PULS NONE
Dependencies	When a new waveform is selected for playback the settings contained within the associated waveform header file are applied to the ARB. The pulse/RF blanking setting is one of the values stored within the header file. If the newly selected waveform file has an associated header file, the pulse/RF blanking setting is updated with the value from the header file. The pulse/RF blanking setting will remain unchanged if the newly selected waveform does not have an associated header file.
Range	None M1 M2 M3 M4
Initial S/W Revision	A.05.00

None

Sets no marker to be used for the pulse/RF blanking function, essentially turning the RF blanking function off.

Key Path	Source, Modulation Setup, ARB, Marker Utilities, Marker Routing, Pulse/RF Blank
Example	:SOUR:RAD:ARB:MDES:PULS NONE
Initial S/W Revision	A.05.00

Marker 1

Sets marker 1 to be used for the pulse/RF blanking function.

Key Path	Source, Modulation Setup, ARB, Marker Utilities, Marker Routing, Pulse/RF Blank
Example	:SOUR:RAD:ARB:MDES:PULS M1
Initial S/W Revision	A.05.00

Marker 2

Sets marker 2 to be used for the pulse/RF blanking function.

Key Path	Source, Modulation Setup, ARB, Marker Utilities, Marker Routing, Pulse/RF Blank
Example	:SOUR:RAD:ARB:MDES:PULS M2
Initial S/W Revision	A.05.00

Marker 3

Sets marker 3 to be used for the pulse/RF blanking function.

Key Path	Source, Modulation Setup, ARB, Marker Utilities, Marker Routing, Pulse/RF Blank
Example	:SOUR:RAD:ARB:MDES:PULS M3
Initial S/W Revision	A.05.00

Marker 4

Sets marker 4 to be used for the pulse/RF blanking function.

Key Path	Source, Modulation Setup, ARB, Marker Utilities, Marker Routing, Pulse/RF Blank
Example	:SOUR:RAD:ARB:MDES:PULS M4
Initial S/W Revision	A.05.00

ALC Hold

Allows you to specify which marker is routed for use within the ALC hold function. The ALC hold marker function holds the ALC circuitry at the average value of the sample points set by the marker.

The ALC hold function operates during the low periods of the marker signal. The marker polarity determines when the marker signal is high. For positive polarity, this is during the marker points. For a negative polarity, this is when there are no marker points.

Key Path	Source, Modulation Setup, ARB, Marker Utilities, Marker Routing
Remote Command	:SOURce:RADio:ARB:MDEStination:ALCHold NONE M1 M2 M3 M4 :SOURce:RADio:ARB:MDEStination:ALCHold?
Example	:SOUR:RAD:ARB:MDES:ALCH NONE
Dependencies	When a new waveform is selected for playback the settings contained within the associated waveform header file are applied to the ARB. The ALC hold setting is one of the values stored within the header file. If the newly selected waveform file has an associated header file, the ALC hold setting is updated with the value from the header file. The ALC hold setting will remain unchanged if the newly selected waveform does not have an associated header file.
Range	None M1 M2 M3 M4
Initial S/W Revision	A.05.00

None

Sets no marker to be used for the ALC hold function, essentially turning the ALC hold function off.

Key Path	Source, Modulation Setup, ARB, Marker Utilities, Marker Routing, ALC Hold
Example	:SOUR:RAD:ARB:MDES:PULS NONE
Initial S/W Revision	A.05.00

Marker 1

Sets marker 1 to be used for the ALC hold function.

Key Path	Source, Modulation Setup, ARB, Marker Utilities, Marker Routing, ALC Hold
Example	:SOUR:RAD:ARB:MDES:PULS M1
Initial S/W Revision	A.05.00

Marker 2

Sets marker 2 to be used for the ALC hold function.

Key Path	Source, Modulation Setup, ARB, Marker Utilities, Marker Routing, ALC Hold
Example	:SOUR:RAD:ARB:MDES:PULS M2
Initial S/W Revision	A.05.00

Marker 3

Sets marker 3 to be used for the ALC hold function.

Key Path	Source, Modulation Setup, ARB, Marker Utilities, Marker Routing, ALC Hold
Example	:SOUR:RAD:ARB:MDES:PULS M3
Initial S/W Revision	A.05.00

Marker 4

Sets marker 4 to be used for the ALC hold function.

Key Path	Source, Modulation Setup, ARB, Marker Utilities, Marker Routing, ALC Hold
Example	:SOUR:RAD:ARB:MDES:PULS M4
Initial S/W Revision	A.05.00

Header Utilities

Allows access to the header utilities sub-menu. Pressing this key also causes the central display area to change to display the File Header Information view.

Key Path	Source, Modulation Setup, ARB
Dependencies	This key is only available if there is currently a waveform selected for playback. If no waveform is selected, the key is grayed out.
Initial S/W Revision	A.05.00

Clear Header

Allows you to clear the header information from the file header associated with the currently selected waveform.

Key Path	Source, Modulation Setup, ARB, Header Utilities
Remote Command	:SOURce:RADio:ARB:HEADer:CLEar
Example	:SOUR:RAD:ARB:HEAD:CLE
Notes	Attempting to clear the header details via SCPI when no waveform was selected for playback will generate an error.
Initial S/W Revision	A.05.00

Save Setup To Header

Allows you to save new file header information details to the file.

Key Path	Source, Modulation Setup, ARB, Header Utilities
Remote Command	:SOURce:RADio:ARB:HEADer:SAVE
Example	:SOUR:RAD:ARB:HEAD:SAVE
Notes	Attempting to save the header details via SCPI when no waveform was selected for playback will generate an error.
Initial S/W Revision	A.05.00

AM

Allows access to the menu for configuring the Amplitude Modulation.

Key Path	Source, Modulation Setup
Initial S/W Revision	A.05.00

AM

Enables or disables the amplitude modulation.

Turning AM on when another modulation format is already on results in the previous modulation format being turned off and the generation of an error.

Key Path	Source, Modulation Setup, AM
Remote Command	:SOURce:AM:STATe :SOURce:AM:STATe?
Example	:SOUR:AM:STAT OFF

Preset	Off
Range	On Off
Initial S/W Revision	A.05.00

AM Depth

Allows you to set the amplitude modulation depth in percent.

Key Path	Source, Modulation Setup, AM
Remote Command	:SOURce:AM[:DEPTh] [:LINear] :SOURce:AM[:DEPTh] [:LINear]?
Example	:SOUR:AM 0.1
Preset	0.1 %
Min	0.1 %
Max	95.0 %
Initial S/W Revision	A.05.00

AM Rate

Allows you to set the internal amplitude modulation rate.

Key Path	Source, Modulation Setup, AM
Remote Command	:SOURce:AM:INTernal:FREQuency :SOURce:AM:INTernal:FREQuency?
Example	:SOUR:AM:INT:FREQ 40.0 Hz
Preset	400.0 Hz
Min	10 Hz
Max	40 kHz
Initial S/W Revision	A.05.00

FM

Allows access to the menu for configuring the frequency modulation.

Key Path	Source, Modulation Setup
Initial S/W Revision	A.05.00

FM

Enables or disables the frequency modulation.

Turning FM on when another modulation format is already on results in the previous modulation format being turned off and the generation of an error.

Key Path	Source, Modulation Setup, FM
Remote Command	:SOURce:FM:STATe :SOURce:FM:STATe?
Example	:SOUR:FM:STAT OFF
Preset	Off
Range	On Off
Initial S/W Revision	A.05.00

FM Deviation

Allows you to set the frequency modulation deviation.

Key Path	Source, Modulation Setup, FM
Remote Command	:SOURce:FM[:DEVIation] :SOURce:FM[:DEVIation]?
Example	:SOUR:FM 1.00 kHz
Preset	1.00 Hz
Min	1.00 Hz
Max	100.00 kHz
Initial S/W Revision	A.05.00

FM Rate

Allows you to set the internal frequency modulation rate.

Key Path	Source, Modulation Setup, FM
Remote Command	:SOURce:FM:INTernal:FREQuency :SOURce:FM:INTernal:FREQuency?
Example	:SOUR:FM:INT:FREQ 40.0 Hz
Preset	400.0 Hz
Min	10 Hz
Max	40 kHz
Initial S/W Revision	A.05.00

PM

Allows access to the menu for configuring the phase modulation.

Key Path	Source, Modulation Setup
Initial S/W Revision	A.05.00

PM

Enables or disables the phase modulation.

Turning PM on when another modulation format is already on results in the previous modulation format being turned off and the generation of an error.

Key Path	Source, Modulation Setup, PM
Remote Command	:SOURce:PM:STATe :SOURce:PM:STATe?
Example	:SOUR:PM:STAT OFF
Preset	Off
Range	On Off
Initial S/W Revision	A.05.00

PM Deviation

Allows you to set the phase modulation deviation.

Key Path	Source, Modulation Setup, PM
Remote Command	:SOURce:PM[:DEViation] :SOURce:PM[:DEViation]?
Example	:SOUR:PM 1.00 rad
Preset	0.1 rad
Min	0.1 rad
Max	20.0 rad
Initial S/W Revision	A.05.00

PM Rate

Allows you to set the internal phase modulation rate.

Key Path	Source, Modulation Setup, PM
Remote Command	:SOURce:PM:INTernal:FREQuency :SOURce:PM:INTernal:FREQuency?

Example	:SOUR:PM:INT:FREQ 40.0 Hz
Preset	400.0 Hz
Min	10 Hz
Max	40 kHz
Initial S/W Revision	A.05.00

List Sequencer

Allows you access to the sub-menus for configuring the list sequencer.

List sequences allows you to enter frequencies and amplitudes at unequal intervals in nonlinear ascending, descending or random order. Each step within the list can also include its own waveform file for playback, step duration, trigger event and trigger output.

The complexities involved in configuring the list sequencer do not lend itself to manual configuration; hence the manual configuration for this feature is limited. For easier configuration of the list sequencer, it is recommended that you use either SCPI or load a tab delimited file containing the setup parameters in a tabular form. The details of the SCPI for configuring the list sequencer can be found in Step Configuration (Remote Command Only).

Once the List Sequencer has been configured using the front panel, SCPI, or loading in a tab delimited file, the sequence must be initiated using the front panel Initiate Sequence key or the corresponding SCPI command.

Key Path	Source
Initial S/W Revision	A.05.00

Sequencer

Allows you to set the state of the list sequencer. When the list sequencer is on, the source is outputting the sequence defined by the sequencer. When the list sequencer is off, the source outputs a single waveform segment or sequence (independent mode) at a single frequency and amplitude.

Key Path	Source, List Sequencer
Remote Command	:SOURce:LIST[:STATe] ON OFF 1 0 :SOURce:LIST[:STATe]?
Example	:SOUR:LIST OFF
Notes	When the sequencer is set to ON, the list sequencer controls the output of the source.
Couplings	When in Sequence Analyzer mode and the list sequencer state is Off, Include Source is forced to No, and the Include Source key is grayed out. When in Sequence Analyzer mode and the list sequencer state is On, Include Source is available to set. And, an ARB memory related operation, like load or delete will be rejected.

Preset	Off
Range	On Off
Initial S/W Revision	A.05.00

Initiate Sequence

Pressing this key arms the sequence for single execution. Once the sequence is armed the source begins the sequence as soon as the trigger is received. If the trigger is set to Free Run, the sequence starts immediately.

Key Path	Source, List Sequencer
Remote Command	:SOURce:LIST:TRIGger[:IMMediate]
Example	:SOUR:LIST:TRIG
Notes	<p>When in Sequence Analyzer mode and Include Source is Yes, the Initiate list sequencer operation is rejected, and the key is grayed out, since source list sequence request is sent to physics via Parallel batch by sequence analyzer.</p> <p>If the file needed by the sequencer is not already in ARB memory, the sequence cannot be initiated and an error will be generated.</p> <p>There is a blocking SCPI query which can be used to query if source list sequence being initiated successfully or not. (see Query List Sequence Initiation Armed Status (Remote Command Only) Query Source List Sequence Armed Status)</p>
Dependencies	Under the Sequence Analyzer Mode, if Meas Setup->Include Source is set to YES, Source->List Sequencer->Initiate Sequence is disabled.
Initial S/W Revision	A.05.00

List Sequencer Setup

Allows you access to the list sequencer setup menus.

Key Path	Source, List Sequencer
----------	------------------------

Number of Steps

Allows you to specify the number of steps within the list sequence.

Key Path	Source, List Sequencer, List Sequencer Setup
Remote Command	:SOURce:LIST:NUMBer:STEPs <integer> :SOURce:LIST:NUMBer:STEPs?
Example	:SOUR:LIST:NUMB:STEP 1
Notes	Increasing the number of steps creates additional steps at the end of the list, with all the settings

	within the steps set to their default values. Decreasing the number of steps removes steps from the end of the list. The settings within the removed steps are not reset. This means that increasing the number of steps again would allow you to retrieve these steps.
Dependencies	The Step Count parameter is increased or decreased when you insert or delete a point from within the GUI interface to the sequencer.
Preset	1
Min	1
Max	1000
Initial S/W Revision	A.05.00

Current Step

Allows you to select the step number you wish to view or edit.

Key Path	Source, List Sequencer, List Sequencer Setup
Notes	No remote command, front panel only.
Preset	1
Min	1
Max	Step Count
Initial S/W Revision	A.05.00

Insert Step Before

Allows you to insert a new step, containing default values, before the currently selected step. Inserting a step will automatically increase the Step Count parameter by 1. If sequence already reaches upper limit of 1000 steps, then insert more step will be rejected and popup error –221, “Setting Conflict; Cannot insert more steps, maximum number of steps reached”

Key Path	Source, List Sequencer, List Sequencer Setup
Notes	No remote command, front panel only. If the list already contains the maximum limit of 1000 steps, no operation will be made after pressing this key.
Initial S/W Revision	A.05.00

Delete Step

Allows you to delete the current step. Deleting a step will automatically decrease the Step Count parameter by 1. If sequence only has one step left, delete step will be rejected and popup error –221, “Setting conflict; Cannot delete current step, minimum number of steps reached”

Key Path	Source, List Sequencer, List Sequencer Setup
Notes	No remote command, Front Panel key only. If the list already contains the minimum limit of 1 step, no operation will be made after pressing this key
Initial S/W Revision	A.05.00

Clear List

Allows you to clear the list. Clearing the list sets the number of steps to the default value of 1 and sets the parameters for the only step to their default values.

Key Path	Source, List Sequencer, List Sequencer Setup
Initial S/W Revision	A.05.00

Step Trigger

Allows access to the sub-menu for selecting the trigger input for the current step.

Key Path	Source, List Sequencer, List Sequencer Setup
Remote Command	:SOURce:LIST:STEP[1] 2 3...1000:SETup:INPut:TRIGger IMMEDIATE INTERNAL EXTERNAL2 KEY BUS EXTERNAL4 :SOURce:LIST:STEP[1] 2 3...1000:SETup:INPut:TRIGger?
Example	:SOUR:LIST:STEP2:SET:INP:TRIG BUS :SOUR:LIST:STEP2:SET:INP:TRIG?
Notes	SCPI is supported after A.09.40
Preset	Free Run
Range	Free Run Internal Manual (Trigger Key) Bus External 2 EXTERNAL4
Initial S/W Revision	A.05.00

Free Run

Sets the trigger input for the current step to Free Run.

Key Path	Source, List Sequencer, List Sequencer Setup, Step Trigger
Example	:SOUR:LIST:STEP2:SET:INP:TRIG IMM
Notes	SCPI is supported after A.09.40
Initial S/W Revision	A.05.00

Internal

Sets the trigger input for the current step to Internal.

Key Path	Source, List Sequencer, List Sequencer Setup, Step Trigger
Example	:SOUR:LIST:STEP2:SET:INP:TRIG INT
Notes	SCPI is supported after A.09.40
Initial S/W Revision	A.05.00

Manual (Trigger Key)

Sets the trigger input for the current step to Manual (Trigger Key). Any step in the sequence set to Manual will cause the sequence execution to stop until the manual trigger key is pressed. Sending the Bus Trigger SCPI command will have no effect. At any point in the sequence where the list sequencer is paused waiting for a software trigger, a pop up dialog is displayed until the trigger event occurs.

Key Path	Source, List Sequencer, List Sequencer Setup, Step Trigger
Example	:SOUR:LIST:STEP2:SET:INP:TRIG KEY
Notes	SCPI is supported after A.09.40
Initial S/W Revision	A.05.00

Bus

Sets the trigger input for the current step to Bus. Any step in the sequence set to Bus will cause the sequence execution to stop until the Bus Trigger SCPI command is sent. Pressing the manual trigger key has no effect. At any point in the sequence where the list sequencer is paused waiting for a software trigger, a pop up dialog is displayed until the trigger event occurs.

Key Path	Source, List Sequencer, List Sequencer Setup, Step Trigger
Example	:SOUR:LIST:STEP2:SET:INP:TRIG BUS
Notes	SCPI is supported after A.09.40
Initial S/W Revision	A.05.00

External 2

Sets the trigger input for the current step to External 2.

Key Path	Source, List Sequencer, List Sequencer Setup, Step Trigger
Example	:SOUR:LIST:STEP2:SET:INP:TRIG EXT2
Notes	SCPI is supported after A.09.40
Notes	Note: When on E6640A, trigger 2 is a bi-directional trigger port. So when trigger 2 has been configured as OUTPUT type, choosing External 2 as the input trigger for the current step will generate error.
Initial S/W Revision	A.05.00

Transition Time

Allows you to specify the transition time for the current step.

The transition time is the amount of time allowed for the source to settle at the current frequency or amplitude value.

Transition Time should not be taken as additional time before or inside the Step Duration. You can set a value for the settling time to allow the source output frequency or amplitude to become stable. Make sure that during this period of time, you do not use the source output signal.

The following table lists recommended values for appropriate settling times to allow for changes within the source.

Value Changed	Recommended Transition Time
Frequency	500 μ s
Amplitude	100 μ s to within 0.1 dB 20 μ s to within 1.0 dB

If the Transition Time value is shorter than the time necessary for the hardware to settle and a List Sequence is initiated, a **warning** is generated.

If the Transition Time value is longer than the Step Duration, an error is generated when initiating a source list sequence. For source list sequence, transition time is included in the step duration length. If the Transition Time value is longer than the Step Duration Time, the real step duration length is extended to equal the transition time and cause a timing shift.

Key Path	Source, List Sequencer, List Sequencer Setup
Remote Command	:SOURce:LIST:STEP[1] 2 3...1000:SETup:TRANSition:TIME <time> :SOURce:LIST:STEP[1] 2 3...1000:SETup:TRANSition:TIME?
Example	:SOUR:LIST:STEP2:SET:TRAN:TIME 1ms :SOUR:LIST:STEP2:SET:TRAN:TIME?
Notes	SCPI is supported after A.09.40
Preset	1.0 ms
Min	0.0 ms
Max	4.0 ks
Initial S/W Revision	A.05.00

Radio Setup

Allows you access to the sub-menus for setting up the radio standard, band, and radio band link direction for the current step.

Key Path	Source, List Sequencer, List Sequencer Setup
Notes	No remote command, front panel only.

Initial S/W Revision	A.05.00
----------------------	---------

Radio Standard

Allows access to the sub-menus for selecting the radio standard and the associated radio band for use in the current step.

Key Path	Source, List Sequencer, List Sequencer Setup, Radio Setup
Remote Command	:SOURce:LIST:STEP[1] 2 3...1000:SETup:RADio:BAND NONE PGSM EGSM RGSM DCS1800 PCS1900 TGSM810 GSM450 GSM480 GSM700 GSM850 BANDI BANDII BANDIII BANDIV BANDV BANDVI BANDVII BANDVIII BANDIX BANDX BANDXI BANDXII BANDXIII BANDXIV BANDXIX USCELL USPCS JAPAN KOREAN NMT IMT2K UPPER SECOND PAMR400 PAMR800 IMTEXT PCS1DOT9G AWS US2DOT5G PUBLIC LOWER NONE BAND1 BAND2 BAND3 BAND4 BAND5 BAND6 BAND7 BAND8 BAND10 BAND11 BAND12 BAND13 BAND14 BAND17 BAND18 BAND19 BAND20 BAND21 BAND24 BAND25 BAND26 BAND27 BAND28 BAND29 BAND30 BAND31 BAND33 BAND34 BAND35 BAND36 BAND37 BAND38 BAND39 BAND40 BAND41 BAND42 BAND43 BAND44 BANDA BANDB BANDC BANDD BANDE BANDF :SOURce:LIST:STEP[1] 2 3...1000:SETup: RADio:BAND?
Example	:SOUR:LIST:STEP2:SET:RAD:BAND PGSM :SOUR:LIST:STEP2:SET:RAD:BAND?
Notes	SCPI is supported after A.09.40
Initial S/W Revision	A.05.00

None

Selects no radio standard for use on the current step.

Key Path	Source, List Sequencer, List Sequencer Setup, Radio Setup, Radio Standard
Example	:SOUR:LIST:STEP2:SET:RAD:BAND NONE
Notes	SCPI is supported after A.09.40
Initial S/W Revision	A.05.00

GSM/EDGE

Pressing this key once selects GSM/EDGE as the radio standard and the current GSM/EDGE band as the active channel band. Pressing this key again allows access to the sub-menus for selecting a different GSM/EDGE band.

Key Path	Source, List Sequencer, List Sequencer Setup, Radio Setup, Radio Standard
Initial S/W Revision	A.05.00

P-GSM

Selects P-GSM as the band for the current step.

Key Path	Source, List Sequencer, List Sequencer Setup, Radio Setup, Radio Standard, GSM/EDGE
Initial S/W Revision	A.05.00

E-GSM

Selects E-GSM as the band for the current step.

Key Path	Source, List Sequencer, List Sequencer Setup, Radio Setup, Radio Standard, GSM/EDGE
Initial S/W Revision	A.05.00

R-GSM

Selects R-GSM as the band for the current step.

Key Path	Source, List Sequencer, List Sequencer Setup, Radio Setup, Radio Standard, GSM/EDGE
Initial S/W Revision	A.05.00

DCS 1800

Selects DCS 1800 as the band for the current step.

Key Path	Source, List Sequencer, List Sequencer Setup, Radio Setup, Radio Standard, GSM/EDGE
Initial S/W Revision	A.05.00

PCS 1900

Selects PCS 1900 as the band for the current step.

Key Path	Source, List Sequencer, List Sequencer Setup, Radio Setup, Radio Standard, GSM/EDGE
Initial S/W Revision	A.05.00

GSM 450

Selects GSM 450 as the band for the current step.

Key Path	Source, List Sequencer, List Sequencer Setup, Radio Setup, Radio Standard, GSM/EDGE
Initial S/W Revision	A.05.00

GSM 480

Selects GSM 480 as the band for the current step.

Key Path	Source, List Sequencer, List Sequencer Setup, Radio Setup, Radio Standard, GSM/EDGE
Initial S/W Revision	A.05.00

GSM 850

Selects GSM 850 as the band for the current step.

Key Path	Source, List Sequencer, List Sequencer Setup, Radio Setup, Radio Standard, GSM/EDGE
Initial S/W Revision	A.05.00

GSM 700

Selects GSM 700 as the band for the current step.

Key Path	Source, List Sequencer, List Sequencer Setup, Radio Setup, Radio Standard, GSM/EDGE
Initial S/W Revision	A.05.00

T-GSM 810

Selects T-GSM 810 as the band for the current step.

Key Path	Source, List Sequencer, List Sequencer Setup, Radio Setup, Radio Standard, GSM/EDGE
Initial S/W Revision	A.05.00

WCDMA

Pressing this key once selects WCDMA as the radio standard and the current WCDMA band as the active channel band. Pressing this key again allows access to the sub-menus for selecting a different WCDMA band.

Key Path	Source, List Sequencer, List Sequencer Setup, Radio Setup, Radio Standard
Initial S/W Revision	A.05.00

Band I

Selects Band I as the band for the current step.

Key Path	Source, List Sequencer, List Sequencer Setup, Radio Setup, Radio Standard, WCDMA
Initial S/W Revision	A.05.00

Band II

Selects Band II as the band for the current step.

Key Path	Source, List Sequencer, List Sequencer Setup, Radio Setup, Radio Standard, WCDMA
Initial S/W Revision	A.05.00

Band III

Selects Band III as the band for the current step.

Key Path	Source, List Sequencer, List Sequencer Setup, Radio Setup, Radio Standard, WCDMA
Initial S/W Revision	A.05.00

Band IV

Selects Band IV as the band for the current step.

Key Path	Source, List Sequencer, List Sequencer Setup, Radio Setup, Radio Standard, WCDMA
Initial S/W Revision	A.05.00

Band V

Selects Band V as the band for the current step.

Key Path	Source, List Sequencer, List Sequencer Setup, Radio Setup, Radio Standard, WCDMA
Initial S/W Revision	A.05.00

Band VI

Selects Band VI as the band for the current step.

Key Path	Source, List Sequencer, List Sequencer Setup, Radio Setup, Radio Standard, WCDMA
Initial S/W Revision	A.05.00

Band VII

Selects Band VII as the band for the current step.

Key Path	Source, List Sequencer, List Sequencer Setup, Radio Setup, Radio Standard, WCDMA
Initial S/W Revision	A.05.00

Band VIII

Selects Band VIII as the band for the current step.

Key Path	Source, List Sequencer, List Sequencer Setup, Radio Setup, Radio Standard, WCDMA
Initial S/W Revision	A.05.00

Band IX

Selects Band IX as the band for the current step.

Key Path	Source, List Sequencer, List Sequencer Setup, Radio Setup, Radio Standard, WCDMA
Initial S/W Revision	A.05.00

Band X

Selects Band X as the band for the current step.

Key Path	Source, List Sequencer, List Sequencer Setup, Radio Setup, Radio Standard, WCDMA
Initial S/W Revision	A.05.00

Band XI

Selects Band XI as the band for the current step.

Key Path	Source, List Sequencer, List Sequencer Setup, Radio Setup, Radio Standard, WCDMA
Initial S/W Revision	A.05.00

Band XII

Selects Band XII as the band for the current step.

Key Path	Source, List Sequencer, List Sequencer Setup, Radio Setup, Radio Standard, WCDMA
Initial S/W Revision	A.05.00

Band XIII

Selects Band XIII as the band for the current step.

Key Path	Source, List Sequencer, List Sequencer Setup, Radio Setup, Radio Standard, WCDMA
Initial S/W Revision	A.05.00

Band XIV

Selects Band XIV as the band for the current step.

Key Path	Source, List Sequencer, List Sequencer Setup, Radio Setup, Radio Standard, WCDMA
Initial S/W Revision	A.05.00

LTE

Pressing this key once selects LTE FDD as the radio standard and the current LTE FDD band as the active channel band. Pressing this key again allows access to the sub-menus for selecting a different LTE FDD band.

Key Path	Source, List Sequencer, List Sequencer Setup, Radio Setup, Radio Standard
Initial S/W Revision	A.09.50

BAND 1

Selects BAND 1 as the band for the current step.

Key Path	Source, List Sequencer, List Sequencer Setup, Radio Setup, Radio Standard, LTE
Initial S/W Revision	A.09.50

BAND 2

Selects BAND 2 as the band for the current step.

Key Path	Source, List Sequencer, List Sequencer Setup, Radio Setup, Radio Standard, LTE
Initial S/W Revision	A.09.50

BAND 3

Selects BAND 3 as the band for the current step.

Key Path	Source, List Sequencer, List Sequencer Setup, Radio Setup, Radio Standard, LTE
Initial S/W Revision	A.09.50

BAND 4

Selects BAND 4 as the band for the current step.

Key Path	Source, List Sequencer, List Sequencer Setup, Radio Setup, Radio Standard, LTE
Initial S/W Revision	A.09.50

BAND 5

Selects BAND 5 as the band for the current step.

Key Path	Source, List Sequencer, List Sequencer Setup, Radio Setup, Radio Standard, LTE
Initial S/W Revision	A.09.50

BAND 6

Selects BAND 6 as the band for the current step.

Key Path	Source, List Sequencer, List Sequencer Setup, Radio Setup, Radio Standard, LTE
Initial S/W Revision	A.09.50

BAND 7

Selects BAND 7 as the band for the current step.

Key Path	Source, List Sequencer, List Sequencer Setup, Radio Setup, Radio Standard, LTE
Initial S/W Revision	A.09.50

BAND 8

Selects BAND 8 as the band for the current step.

Key Path	Source, List Sequencer, List Sequencer Setup, Radio Setup, Radio Standard, LTE
Initial S/W Revision	A.09.50

BAND 9

Selects BAND 9 as the band for the current step.

Key Path	Source, List Sequencer, List Sequencer Setup, Radio Setup, Radio Standard, LTE
Initial S/W Revision	A.09.50

BAND 10

Selects BAND 10 as the band for the current step.

Key Path	Source, List Sequencer, List Sequencer Setup, Radio Setup, Radio Standard, LTE
Initial S/W Revision	A.09.50

BAND 11

Selects BAND 11 as the band for the current step.

Key Path	Source, List Sequencer, List Sequencer Setup, Radio Setup, Radio Standard, LTE
Initial S/W Revision	A.09.50

BAND 12

Selects BAND 12 as the band for the current step.

Key Path	Source, List Sequencer, List Sequencer Setup, Radio Setup, Radio Standard, LTE
Initial S/W Revision	A.09.50

BAND 13

Selects BAND 13 as the band for the current step.

Key Path	Source, List Sequencer, List Sequencer Setup, Radio Setup, Radio Standard, LTE
Initial S/W Revision	A.09.50

BAND 14

Selects BAND 14 as the band for the current step.

Key Path	Source, List Sequencer, List Sequencer Setup, Radio Setup, Radio Standard, LTE
Initial S/W Revision	A.09.50

BAND 17

Selects BAND 17 as the band for the current step.

Key Path	Source, List Sequencer, List Sequencer Setup, Radio Setup, Radio Standard, LTE
Initial S/W Revision	A.09.50

BAND 18

Selects BAND 18 as the band for the current step.

Key Path	Source, List Sequencer, List Sequencer Setup, Radio Setup, Radio Standard, LTE
Initial S/W Revision	A.09.50

BAND 19

Selects BAND 19 as the band for the current step.

Key Path	Source, List Sequencer, List Sequencer Setup, Radio Setup, Radio Standard, LTE
Initial S/W Revision	A.09.50

BAND 20

Selects BAND 20 as the band for the current step.

Key Path	Source, List Sequencer, List Sequencer Setup, Radio Setup, Radio Standard, LTE
Initial S/W Revision	A.09.50

BAND 21

Selects BAND 21 as the band for the current step.

Key Path	Source, List Sequencer, List Sequencer Setup, Radio Setup, Radio Standard, LTE
Initial S/W Revision	A.09.50

BAND 24

Selects BAND 24 as the band for the current step.

Key Path	Source, List Sequencer, List Sequencer Setup, Radio Setup, Radio Standard, LTE
Initial S/W Revision	A.09.50

BAND 25

Selects BAND 25 as the band for the current step.

Key Path	Source, List Sequencer, List Sequencer Setup, Radio Setup, Radio Standard, LTE
Initial S/W Revision	A.09.50

BAND 26

Selects BAND 26 as the band for the current step.

Key Path	Source, List Sequencer, List Sequencer Setup, Radio Setup, Radio Standard, LTE
Initial S/W Revision	A.12.53

BAND 27

Selects BAND 27 as the band for the current step.

Key Path	Source, List Sequencer, List Sequencer Setup, Radio Setup, Radio Standard, LTE
Initial S/W Revision	A.14.00

BAND 28

Selects BAND 28 as the band for the current step.

Key Path	Source, List Sequencer, List Sequencer Setup, Radio Setup, Radio Standard, LTE
Initial S/W Revision	A.14.00

BAND 31

Selects BAND 31 as the band for the current step.

Key Path	Source, List Sequencer, List Sequencer Setup, Radio Setup, Radio Standard, LTE
Initial S/W Revision	A.14.00

LTE TDD

Sets LTE TDD as the radio standard for use and accesses the LTE TDD specific channel band sub-menus..

Key Path	Source, Frequency, Radio Setup, Radio Standard
Initial S/W Revision	A.11.50

BAND 33

Selects BAND 33 as the band for the current step.

Key Path	Source, Frequency, Radio Setup, Radio Standard, LTE TDD
Example	:SOUR:FREQ:CHAN:BAND BAND33
Initial S/W Revision	A.11.50

BAND 34

Selects BAND 34 as the band for the current step.

Key Path	Source, Frequency, Radio Setup, Radio Standard, LTE TDD
Example	:SOUR:FREQ:CHAN:BAND BAND34
Initial S/W Revision	A.11.50

BAND 35

Selects BAND 35 as the band for the current step.

Key Path	Source, Frequency, Radio Setup, Radio Standard, LTE TDD
Example	:SOUR:FREQ:CHAN:BAND BAND35
Initial S/W Revision	A.11.50

BAND 36

Selects BAND 36 as the band for the current step.

Key Path	Source, Frequency, Radio Setup, Radio Standard, LTE TDD
Example	:SOUR:FREQ:CHAN:BAND BAND36
Initial S/W Revision	A.11.50

BAND 37

Selects BAND 37 as the band for the current step.

Key Path	Source, Frequency, Radio Setup, Radio Standard, LTE TDD
Example	:SOUR:FREQ:CHAN:BAND BAND37
Initial S/W Revision	A.11.50

BAND 38

Selects BAND 38 as the band for the current step.

Key Path	Source, Frequency, Radio Setup, Radio Standard, LTE TDD
Example	:SOUR:FREQ:CHAN:BAND BAND38
Initial S/W Revision	A.11.50

BAND 39

Selects BAND 39 as the band for the current step.

Key Path	Source, Frequency, Radio Setup, Radio Standard, LTE TDD
Example	:SOUR:FREQ:CHAN:BAND BAND39
Initial S/W Revision	A.11.50

BAND 40

Selects BAND 40 as the band for the current step.

Key Path	Source, Frequency, Radio Setup, Radio Standard, LTE TDD
Example	:SOUR:FREQ:CHAN:BAND BAND40
Initial S/W Revision	A.11.50

BAND 41

Selects BAND 41 as the band for the current step.

Key Path	Source, Frequency, Radio Setup, Radio Standard, LTE TDD
Example	:SOUR:FREQ:CHAN:BAND BAND41
Initial S/W Revision	A.11.50

BAND 42

Selects BAND 42 as the band for the current step.

Key Path	Source, Frequency, Radio Setup, Radio Standard, LTE TDD
Example	:SOUR:FREQ:CHAN:BAND BAND42
Initial S/W Revision	A.11.50

BAND 43

Selects BAND 43 as the band for the current step.

Key Path	Source, Frequency, Radio Setup, Radio Standard, LTE TDD
Example	:SOUR:FREQ:CHAN:BAND BAND43
Initial S/W Revision	A.11.50

BAND 44

Selects BAND 44 as the band for the current step.

Key Path	Source, List Sequencer, List Sequencer Setup, Radio Setup, Radio Standard, LTE TDD
Initial S/W Revision	A.14.00

TDSCDMA

Sets TDSCDMA as the radio standard for use and accesses the TDSCDMA specific channel band sub-menus..

Key Path	Source, Frequency, Radio Setup, Radio Standard
Initial S/W Revision	A.11.50

BAND A

Selects BAND A as the band for the current step.

Key Path	Source, Frequency, Radio Setup, Radio Standard, TDSCDMA
Example	:SOUR:FREQ:CHAN:BAND BANDA
Initial S/W Revision	A.11.50

BAND B

Selects BAND B as the band for the current step.

Key Path	Source, Frequency, Radio Setup, Radio Standard, TDSCDMA
Example	:SOUR:FREQ:CHAN:BAND BANDB
Initial S/W Revision	A.11.50

BAND C

Selects BAND C as the band for the current step.

Key Path	Source, Frequency, Radio Setup, Radio Standard, TDSCDMA
Example	:SOUR:FREQ:CHAN:BAND BANDC
Initial S/W Revision	A.11.50

BAND D

Selects BAND D as the band for the current step.

Key Path	Source, Frequency, Radio Setup, Radio Standard, TDSCDMA
Example	:SOUR:FREQ:CHAN:BAND BANDD
Initial S/W Revision	A.11.50

BAND E

Selects BAND E as the band for the current step.

Key Path	Source, Frequency, Radio Setup, Radio Standard, TDSCDMA
Example	:SOUR:FREQ:CHAN:BAND BANDE
Initial S/W Revision	A.11.50

BAND F

Selects BAND F as the band for the current step.

Key Path	Source, Frequency, Radio Setup, Radio Standard, TDSCDMA
Example	:SOUR:FREQ:CHAN:BAND BANDF
Initial S/W Revision	A.11.50

Radio Band Link

Allows you to specify the radio band link direction for the steps within the list sequence. The link is used in conjunction with the channel band and channel number to determine the output frequency.

When set to “Uplink”, the source will calculate the uplink frequency according to an uplink formula together with selected channel band and channel number. When set to “Downlink”, the source will calculate the downlink frequency according to a downlink formula together with selected channel band and channel number.

Key Path	Source, List Sequencer, List Sequencer Setup, Radio Setup
Remote Command	:SOURce:LIST:STEP[1] 2 3...1000:SETup:RADio:BAND:LINK DOWN UP :SOURce:LIST:STEP[1] 2 3...1000:SETup:RADio:BAND:LINK?
Example	:SOUR:LIST:STEP2:SET:RAD:BAND:LINK UP :SOUR:LIST:STEP2:SET:RAD:BAND:LINK?
Notes	SCPI is supported after A.09.40
Preset	DOWN
Range	DOWN UP
Initial S/W Revision	A.05.00

Channel

Allows you to specify the frequency of the current step via a channel number.

Key Path	Source, List Sequencer, List Sequencer Setup
Remote Command	:SOURce:LIST:STEP[1] 2 3...1000:SETup:CNFRrequency <double> :SOURce:LIST:STEP[1] 2 3...1000:SETup:CNFRrequency?
Example	:SOUR:LIST:STEP2:SET:CNFR 124 :SOUR:LIST:STEP2:SET:CNFR?
Notes	SCPI is supported after A.09.40. This SCPI is used to setup channel number or frequency setting, according to current Radio Band setting. If Radio Band is "NONE", then it's frequency. If Radio Band is not "NONE", then it's channel number.
Couplings	The channel number is coupled to the step frequency value. When the step frequency value is changed, the channel number will increase or decrease to match the new step frequency. If the step frequency is not at an exact match for a channel number, the nearest channel number is displayed, along with a greater than, or less than sign to indicate the frequency is above or below the channel number.
Preset	1
Min	0 (Please refer to for valid ranges.)
Max	10838 (Please refer to for valid ranges.)
Initial S/W Revision	A.05.00

Frequency

Allows you to specify a frequency value for the current step.

Key Path	Source, List Sequencer, List Sequencer Setup
Remote Command	:SOURce:LIST:STEP[1] 2 3...1000:SETup:CNFRrequency <double> :SOURce:LIST:STEP[1] 2 3...1000:SETup:CNFRrequency?
Example	:SOUR:LIST:STEP2:SET:CNFR 1GHz :SOUR:LIST:STEP2:SET:CNFR?
Notes	SCPI is supported after A.09.40. This SCPI is used to setup channel number or frequency setting, according to current Radio Band setting. If Radio Band is "NONE", then it's frequency. If Radio Band is not "NONE", then it's channel number.
Couplings	The frequency value is coupled to the channel band and number for the step, such that updates to the radio band and channel number will update the frequency value to the corresponding absolute frequency. The reverse is also true, changing the frequency value causes the value of the channel number to be updated.
Preset	1.00 GHz
Min	10.00 MHz
Max	Hardware Dependant:

	Option 503 = 3.6 GHz Option 504 = 3.9 GHz Option 506 = 6.00 GHz
Initial S/W Revision	A.05.00

Power

Allows you to specify a power value for the current step.

Key Path	Source, List Sequencer, List Sequencer Setup
Remote Command	:SOURCE:LIST:STEP[1] 2 3...1000:SETup:AMPLitude <double> :SOURCE:LIST:STEP[1] 2 3...1000:SETup:AMPLitude?
Example	:SOUR:LIST:STEP2:SET:AMPL -50dBm :SOUR:LIST:STEP2:SET:AMPL?
Notes	SCPI is supported after A.09.40
Notes	Amplitude corrections can be specified for use with the source. In the event of amplitude corrections being applied, the valid ranges for the RF power do not change dependant on the current amplitude correction setting. Instead, if the combination of RF power + amplitude correction is higher or lower than the source output range, the Source Unleveled bit is set and the "Source Unleveled" indicator will appear on status panel to indicate that the source cannot maintain the output power that has been requested. The multiport adapter RFIO TX ports and GPS ports cannot ensure power accuracy when power setting is lower than -130dBm, this power setting value is defined by the sum of RF Power setting and related amplitude correction value. But user settable value could be lower than this limit. When application detected there exists power setting lower than -130dBm on MPA RFIO TX ports, then popup warning message . When application detected there exists power setting lower than -130dBm on MPA GPS ports, then popup warning message . These are only warning messages, and check is performed when RF is ON.
Notes	The Min and Max value here defined UI settable amplitude range. This range is larger than actual amplitude range with level accuracy defined in spec.
Dependencies	The RF power is dependent on the RF output port and frequency, such that the current frequency and selected output port determine the valid range of power values.
Preset	-100 dBm
Min	The range of values depends on the current frequency and selected RF output port. Please refer to "RF Power" on page 2098 and the table RF Power Range for the valid ranges.
Max	The range of values depends on the current frequency and selected RF output port. Please refer to "RF Power" on page 2098 and the table RF Power Range for the valid ranges.
Initial S/W Revision	A.05.00

Waveform

Allows you access to the sub-menus for selecting the waveform to be played back during the current step. Pressing this key also changes the central display area to show the Waveform File Selection view.

Key Path	Source, List Sequencer, List Sequencer Setup
Remote Command	:SOURce:LIST:STEP[1] 2 3...1000:SETup:WAVeform <string> :SOURce:LIST:STEP[1] 2 3...1000:SETup:WAVeform?
Example	:SOUR:LIST:STEP2:SET:WAV "CW" :SOUR:LIST:STEP2:SET:WAV?
Notes	SCPI is supported after A.09.40
Remote Command Notes	String type, takes "Off" "CW" "Cont" "waveform name"
Preset	CW
Range	Waveform Continue Previous CW Off
Initial S/W Revision	A.05.00

CW

Sets the current step to output a CW tone.

Key Path	Source, List Sequencer, List Sequencer Setup, Waveform
Example	:SOUR:LIST:STEP2:SET:WAV "CW"
Notes	SCPI is supported after A.09.40
Initial S/W Revision	A.05.00

Selected Waveform

Inserts the currently selected waveform in the waveform selection view as the waveform for playback during the current step.

Key Path	Source, List Sequencer, List Sequencer Setup, Waveform
Example	:SOUR:LIST:STEP2:SET:WAV "waveform name"
Notes	SCPI is supported after A.09.40 If the selected waveform contains header (which contains ARB play parameters), source list sequence will automatically apply header settings of the selected waveform in that step.
Initial S/W Revision	A.05.00

Continue Previous

Sets the current step to continue with playback of the waveform from the previous step. When continuing the previous waveform, the ARB playback will not pause while the source retunes to the new frequency or amplitude that may be defined for the new step.

Key Path	Source, List Sequencer, List Sequencer Setup, Waveform
----------	--

Example	:SOUR:LIST:STEP2:SET:WAV "Cont"
Notes	SCPI is supported after A.09.40
Initial S/W Revision	A.05.00

Off

Disable RF output of the current step.

Key Path	Source, List Sequencer, List Sequencer Setup, Waveform
Example	:SOUR:LIST:STEP2:SET:WAV "Off"
Notes	SCPI is supported after A.09.40
Initial S/W Revision	A.05.00

Segments on Hard Disk

Allows you access to the sub-menus for loading waveform segments from the hard disk into ARB memory. The default directory is: D: varb.

Pressing this key changes the current view to the Waveform Management View.

Key Path	Source, Modulation Setup, ARB, Select Waveform
Initial S/W Revision	A.05.00

Load Segment To ARB Memory

Allows you to load the selected file into ARB memory. On the front panel you select the file for loading to the ARB memory by highlighting the desired file in the list. Using the SCPI command, you specify the file name on the HDD.

"NVWFM" (none-volatile storage) MSUS (Mass Storage Unit Specifier) is supported in the memory subsystem because the ARB memory cannot be accessed directly. Therefore, files must be downloaded to the instrument hard disk and then loaded into the ARB memory. "NVWFM" MSUS will be mapped to the default directory D: VARB. The SCPI command supports using either "NVWFM" MSUS or specifying a full path. For more information, see Memory Subsystem (Remote Command Only).

If a file of the same name already exists within ARB memory, it is overwritten. If you wish to load two segments of the same name, you must rename one of the segments before loading it into ARB memory. To rename a segment, you can either use Windows File Explorer, or the :MMEMory:COPY command.

NOTE: When a waveform file is loaded to ARB memory, burst timing adjustments are made automatically, based on whether or not a Multiport Adapter is connected to the test set and powered on. If the connection/power status of the Multiport Adapter is changed after a waveform file has been loaded, it needs to be loaded again.

Key Path	Source, Modulation Setup, ARB, Select Waveform, Segments on Hard Disk
Remote Command	:SOURce:RADio:ARB:LOAD <string>
Example	:SOUR:RAD:ARB:LOAD "D: VARB\testwaveform.bin" or :SOUR:RAD:ARB:LOAD "NVWFM:testwaveform.bin"
Notes	<p>Because loading the file involves a delay of unpredictable length, this command should be followed by the query *OPC?, which holds off subsequent commands until the loading operating is complete.</p> <p><string> – specifies the path name of the file to load from the HDD into ARB memory. It could be a <full path + filename>, or <"NVWFM" MSUS + colon + filename>.</p> <p>When in Sequence Analyzer mode, and Include Source is Yes, an attempt to load a file to ARB memory will be rejected with an error.</p> <p>When Include Source is No and if there is insufficient free ARB memory to load the selected waveform, an error is generated. .</p> <p>If you specify a file over SCPI, but the file is not at the specified location, an error is generated.</p> <p>If you try to load a waveform file but the file contains less than 500 IQ samples, an error is generated.</p> <p>If you try to load a Signal Studio waveform "*.wfm" which contains invalid waveform header, an error is generated.</p> <p>If the ARB is ON when you load a file to ARB memory or delete a file from ARB memory, the playing waveform segment may not keep phase continuity during the ARB memory operation. The waveform will be replayed after the ARB operation is finished.</p> <p>ARB can be loaded into ARB memory even required licenses do not present on the instrument. In this case, a GUI only warning message -800, "Operation complete; Loaded <filename> successfully, but no license <required licenses> installed". User can install required licenses according to <required licenses> string to license it, or multi-pack license it.</p>
Initial S/W Revision	A.05.00

Load All To ARB Memory

Allows you to load all the segment files within the currently selected directory into ARB memory. If a file of the same name already exists within ARB memory, it is overwritten. If you wish to load two segments of the same name, you must rename one of the segments before loading it into ARB memory. To rename a segment, you can either use Windows File Explorer, or the :MEMory:COpy command.

NOTE: When a waveform file is loaded to ARB memory, burst timing adjustments are made automatically, based on whether or not a Multiport Adapter is connected to the test set and powered on. If the connection/power status of the Multiport Adapter is changed after a waveform file has been loaded, it needs to be loaded again.

Key Path	Source, Modulation Setup, ARB, Select Waveform, Segments on Hard Disk
Remote Command	:SOURce:RADio:ARB:LOAD:ALL <string>
Example	:SOUR:RAD:ARB:LOAD:ALL "D: varb"
Notes	<p><string> - specifies the directory on the HDD to load the files into ARB memory from.</p> <p>When in Sequence Analyzer mode, and Include Source is Yes, an attempt to load all files from a directory to ARB memory is rejected with an error.</p>

When Include Source is No and there is insufficient free ARB memory to load all the waveforms, when the ARB memory is full, the copy ceases, and an error is generated.

If you specify a directory over SCPI, but the directory does not exist, an error is generated.

If the ARB is ON, a user then loads or deletes file to ARB memory, the playing waveform segment may not keep phase continuity during the ARB memory operation. The waveform will be replayed after the ARB operation is finished.

Initial S/W Revision	A.05.00
----------------------	---------

Change Directory...

Allows you to change the currently selected directory on the hard disk. Pressing this key opens a standard windows change directory dialog allowing you to select the new directory of interest.

The current directory is used for manually loading waveform segments into ARB memory for playback, and as a search location for waveform segments that are required to be loaded into ARB memory for playback of a waveform sequence or a list sequence.

Key Path	Source, Modulation Setup, ARB, Select Waveform, Segments on Hard Disk
Notes	No remote command, SCPI front panel only.
Initial S/W Revision	A.05.00

Default Directory...

Allows you to change the default directory. It is used as a search location for waveform segments that are required to be loaded into ARB memory for playback of a waveform sequence, and as a search location for selecting waveforms using SCPI.

Key Path	Source, Modulation Setup, ARB, Select Waveform, Segments on Hard Disk
Remote Command	:SOURce:RADio:ARB:DEFault:DIRectory <string> :SOURce:RADio:ARB: DEFault:DIRectory?
Example	:SOUR:RAD:ARB:DEF:DIR "D:\ArbFiles" :SOUR:RAD:ARB:DEF:DIR?
State Saved	Persistent, survives a power cycle and a preset but not saved in the instrument state
Initial S/W Revision	A.05.00

Segments in ARB Memory

Allows you access to the sub-menus for managing the files within ARB memory.

Key Path	Source, Modulation Setup, ARB, Select Waveform
Initial S/W Revision	A.05.00

Delete Segment From ARB Mem

Allows you to remove a segment from ARB playback memory.

Key Path	Source, Modulation Setup, ARB, Select Waveform, Segments in ARB Memory
Remote Command	:SOURce:RADio:ARB:DELeTe <string>
Example	:SOUR:RAD:ARB:DEL "testwaveform.bin"
Notes	<p><string> - specifies the waveform to be deleted from the ARB playback memory.</p> <p>When in Sequence Analyzer mode and Include Source is Yes, an attempt to delete a file from ARB memory is rejected with an error.</p> <p>When Include Source is No and you specify a file that does not exist within ARB memory, an error is generated.</p> <p>It is possible to delete files from within the ARB memory when the ARB is ON. However, if you attempt to delete the file that is currently playing an error is generated.</p> <p>It is possible to delete a file from within the ARB memory when the sequencer state is ON and the file is not being used by the List Sequencer. If you attempt to delete a file which is being used by the list sequencer, an error is generated.</p> <p>When sequencer state is On, even if ARB state is On, the selected waveform will not be played. In this case, if the selected waveform is not used in List Sequence, it can be deleted and the ARB state is turned Off.</p> <p>If the ARB is ON and you load a file to ARB memory or delete a file from ARB memory, the playing waveform segment may not keep phase continuity during the ARB memory operation. The waveform will be replayed after the ARB operation is finished.</p>
Initial S/W Revision	A.05.00

Delete All From ARB Memory

Allows you to remove all segments from ARB playback memory.

Key Path	Source, Modulation Setup, ARB, Select Waveform, Segments in ARB Memory
Remote Command	:SOURce:RADio:ARB:DELeTe:ALL
Example	:SOUR:RAD:ARB:DELeTe:ALL
Notes	<p>When in Sequence Analyzer mode and Include Source is Yes, an attempt to delete all files from ARB memory is rejected with an error.</p> <p>When Include Source is No and you attempt to delete all files from ARB memory when the ARB is currently playing a file, all files except the one playing are deleted and an error is generated.</p> <p>If you attempt to delete all files from ARB memory when there are waveform files used in "List Sequencer" on page 2168 and "Sequencer" on page 2168 state is ON, all files except the files currently being used in list sequencer are deleted, and an error is generated.</p> <p>If the ARB is ON and you load a file to ARB memory or delete a file from ARB memory, the playing waveform segment may not keep phase continuity during the ARB memory operation. The waveform will be replayed after the ARB operation is finished.</p>
Initial S/W Revision	A.05.00

Step Duration

Allows access to the sub-menus for setting up the duration of play for the current step.

The duration can be set to be either the number of times for the ARB file associated with the sequence to play, or a specific time value, or continuous. If the step is set to play a CW tone, the step duration cannot be set to a play count.

Key Path	Source, List Sequencer, List Sequencer Setup
Remote Command	:SOURce:LIST:STEP[1] 2 3...1000:SETup:DURation:TYPE TIME COUNT CONTInuous CABort :SOURce:LIST:STEP[1] 2 3...1000:SETup:DURation:TYPE?
Example	:SOUR:LIST:STEP2:SET:DUR:TYPE TIME :SOUR:LIST:STEP2:SET:DUR:TYPE?
Notes	SCPI is supported after A.09.40
Notes	If “Step Duration” is set to “Time” or “Play Count” for the last step, the last step of ARB keeps playing as if set to “Continuous”, until the set “Time” has expired or until the “Play Count” setting is reached. However, you can query Error! Reference source not found. Source Sweeping Condition Message to find out if the current list sequence is complete or not.
Range	Time Play Count Continuous Continuous Abort
Initial S/W Revision	A.05.00

Time

Sets the duration of the current step to be a time value for the length of time the step will play. Pressing this key again opens another menu which allows you to set the time value for the step duration.

Key Path	Source, List Sequencer, List Sequencer Setup, Step Duration
Example	:SOUR:LIST:STEP2:SET:DUR:TYPE TIME
Notes	SCPI is supported after A.09.40
Initial S/W Revision	A.05.00

Duration Time

Allows you to specify the length of time the current step will play.

If the Transition Time value is longer than the Step Duration Time, an error is generated when initiating a source list sequence. For source list sequence, transition time is included in the step duration length (not occupy additional time). If the Transition Time value is longer than the Step Duration Time, the real step duration length is extended to equal the transition time and cause a timing shift. This check is also described in section **Error! Reference source not found.** List Sequence Step Validation.

Key Path	Source, List Sequencer, List Sequencer Setup, Step Duration, Time
Remote Command	:SOURce:LIST:STEP[1] 2 3...1000:SETup:DURation:TCOUNT <double> :SOURce:LIST:STEP[1] 2 3...1000:SETup:DURation:TCOUNT?

Example	:SOUR:LIST:STEP2:SET:DUR:TCO 1s :SOUR:LIST:STEP2:SET:DUR:TCO?
Notes	SCPI is supported after A.09.40 This SCPI is reused by "Play Count", "Duration Time" and "Continuous Abort" according to current Duration Type setting is "Play Count" or "Duration Time" or "Continuous Abort". If current "Duration Type" is "Continuous", then popup error -221, "Settings conflict; Cannot accept time or count input when step duration type is Continuous on step #"
Notes	If "Duration Time" is set for the last step, the last step of ARB keeps playing as if set to "Continuous" after set time expires. However, you can query Source Sweeping Condition Message (:STAT:OPER:COND?) to find out if the current list sequence is complete or not.
Preset	1.00 ms
Min	100 µs
Max	1800 s
Initial S/W Revision	A.05.00

Play Count

Sets the duration of the current step to be an integer value for the number of times (play count) the ARB file is selected for playback during this step. For example, a 5 second ARB will be set to play 5 times during the step.

Key Path	Source, List Sequencer, List Sequencer Setup, Step Duration
Example	:SOUR:LIST:STEP2:SET:DUR:TYPE COUN
Notes	SCPI is supported after A.09.40 This key is unavailable and is grayed out if the current step is configured to CW tone rather than an ARB waveform.
Initial S/W Revision	A.05.00

Header Utilities

Allows access to the header utilities sub-menu. Pressing this key also causes the central display area to change to display the File Header Information view.

Key Path	Source, Modulation Setup, ARB
Dependencies	This key is only available if there is currently a waveform selected for playback. If no waveform is selected, the key is grayed out.
Initial S/W Revision	A.05.00

Continuous

Sets the current step to be played continuously until the next step starts. The waveform will always play completely before transitioning to the next step.

Key Path	Source, List Sequencer, List Sequencer Setup, Step Duration
Example	:SOUR:LIST:STEP2:SET:DUR:TYPE CONT
Notes	SCPI is supported after A.09.40
Initial S/W Revision	A.05.00

Output Trigger

Allows you to specify the trigger output for the current step. The trigger output signal is sent at the start of the step.

When select “On”, trigger event will occur on both Internal and External2 paths. Select “Off” will turn off trigger output.

Key Path	Source, List Sequencer, List Sequencer Setup
Remote Command	:SOURce:LIST:STEP[1] 2 3...1000:SETup:OUTPut:TRIGger ON OFF 1 0 :SOURce:LIST:STEP[1] 2 3...1000:SETup:OUTPut:TRIGger
Example	:SOUR:LIST:STEP2:SET:OUTP:TRIG ON :SOUR:LIST:STEP2:SET:OUTP:TRIG?
Notes	SCPI is supported after A.09.40
Preset	Off
Range	On Off
Initial S/W Revision	A.05.00

Repetition

Allows access to the sub-menu for selecting the repetition type for the list sequencer globally. It cannot be changed between different sequence steps.

Key Path	Source, List Sequencer
Remote Command	:SOURce:LIST:REPetition:TYPE SINGLE CONTInuous
Example	:SOUR:LIST:REP:TYPE SING :SOUR:LIST:REP:TYPE?
Preset	SINGle
Range	SINGle CONTInuous
Initial S/W Revision	A.14.50

Single

Sets the repetition type as single for the whole source sequence. Source list will play one time after initiation.

Key Path	Source, List Sequencer, Repetition
Example	:SOUR:LIST:REP:TYPE SINGLE
Initial S/W Revision	A.14.50

Continuous

Sets the repetition type as continuous for the whole source sequence. Source list will play continuously after initiation.

Key Path	Source, List Sequencer, Repetition
Example	:SOUR:LIST:REP:TYPE CONTInuous
Initial S/W Revision	A.14.50

Trigger Type

Allows access to the sub-menu for selecting the output trigger type for the list sequencer globally. It cannot be changed between different sequence steps.

Key Path	Source, List Sequencer
Remote Command	:SOURce:LIST:TRIGgerout:TYPe BEGInningofstep DATamarker
Example	:SOUR:LIST:TRIG:TYP BEG :SOUR:LIST:TRIG:TYP?
Notes	SCPI is supported after A.14.00
Preset	BEGInningofstep
Range	BEGInningofstep DATamarker
Initial S/W Revision	A.14.00

BeginningOfStep

Sets the output trigger type as BeginningOfStep for the whole source sequence.

Key Path	Source, List Sequencer, Trigger Type
Example	:SOUR:LIST:TRIG:TYP BEG
Notes	SCPI is supported after A.14.00
Initial S/W Revision	A.14.00

DataMarker

Sets the output trigger type as DataMarker for the whole source sequence. When DataMarker is selected, which marker to route is also needed to be set.

Key Path	Source, List Sequencer, Trigger Type
Example	:SOUR:LIST:TRIG:TYP DAT
Notes	SCPI is supported after A.14.00
Initial S/W Revision	A.14.00

Marker 1

Sets the output trigger maker routing to Marker 1 for DataMarker in the whole source sequence.

Key Path	Source, List Sequencer, Trigger Type, DataMarker
Example	:SOUR:LIST:TRIG:TYPE:MARK M1
Notes	SCPI is supported after A.14.00
Initial S/W Revision	A.14.00

Marker 2

Sets the output trigger maker routing to Marker 2 for DataMarker in the whole source sequence.

Key Path	Source, List Sequencer, Trigger Type, DataMarker
Example	:SOUR:LIST:TRIG:TYPE:MARK M2
Notes	SCPI is supported after A.14.00
Initial S/W Revision	A.14.00

Marker 3

Sets the output trigger maker routing to Marker 3 for DataMarker in the whole source sequence.

Key Path	Source, List Sequencer, Trigger Type, DataMarker
Example	:SOUR:LIST:TRIG:TYPE:MARK M3
Notes	SCPI is supported after A.14.00
Initial S/W Revision	A.14.00

Marker 4

Sets the output trigger maker routing to Marker 4 for DataMarker in the whole source sequence.

Key Path	Source, List Sequencer, Trigger Type, DataMarker
Example	:SOUR:LIST:TRIG:TYPE:MARK M4
Notes	SCPI is supported after A.14.00
Initial S/W Revision	A.14.00

Manual Trigger Now

Pressing this key provides a software trigger event to the list sequencer. During execution of sequence, if the sequencer is halted on any step that has been configured with a “Manual” step trigger, then this key press will cause the sequencer to continue and execute the step.

Key Path	Source, List Sequencer
Remote Command	No remote command, front panel only.
Initial S/W Revision	A.05.00

Source Preset

Allows you to preset the source settings to their default values.

Key Path	Source
Remote Command	:SOURce:PRESet
Example	:SOUR:PRES

SPAN X Scale

Accesses a menu of functions that enable you set the horizontal scale parameters.

Key Path	Front-panel key
Initial S/W Revision	Prior to A.02.00

Span

Changes the frequency range symmetrically about the center frequency.

The default (and minimum) span is calculated using the number of carriers and the carrier width where;

$$\text{Span} = (\text{Upper Carrier Freq} + (\text{max offset IBW} * (1 + \alpha)) / 2) - (\text{Lower Carrier Freq} - (\text{max offset IBW} * (1 + \alpha)) / 2)$$

The span is increased by a factor of 1 + Filter Alpha if the RRC Filter is on.

Key Path	SPAN X Scale
Mode	SA, WCDMA, C2K, WIMAX OFDMA, TD-SCDMA, 1xEVDO, DVB-T/H, DTMB (CTTB), ISDB-T, CMMB, LTE, LTE-TDD, Digital Cable TV, MSR, LTEAFDD, LTEATDD
Remote Command	[:SENSe] :ACPower:FREQuency:SPAN <freq> [:SENSe] :ACPower:FREQuency:SPAN?
Example	ACP:FREQ:SPAN 25MHz ACP:FREQ:SPAN?
Notes	You must be in the mode that includes ACP measurements to use this command. Use :INSTrument:SElect to set the mode.
Couplings	The span value is clipped when the carrier settings and/or the offset settings are changed. The value is changed to satisfy following formula: $\text{Span} = (\text{Upper Carrier Freq} + (\text{max offset IBW} * (1 + \alpha)) / 2) - (\text{Lower Carrier Freq} - (\text{max offset IBW} * (1 + \alpha)) / 2)$
Preset	SA: 8 MHz WCDMA: 24.6848 MHz WIMAX OFDMA: 50 MHz C2K: 4.5 MHz TD-SCDMA: 8 MHz 1xEVDO: 4.05 MHz DVB-T/H: 40 MHz DTMB (CTTB): 72 MHz ISDB-T: 30 MHz CMMB: 72 MHz LTE, LTE-TDD, MSR: 25 MHz Digital Cable TV: 40 MHz LTEAFDD, LTEATDD: 25MHz

State Saved	Saved in instrument state.
Min	10 Hz
Max	Hardware Dependent: Option F03 = 3.0 GHz Option F07 = 7.5 GHz Option F13 = 13.6 GHz Option F26 = 26.5 GHz
Initial S/W Revision	Prior to A.02.00
Modified at S/W Revision	A.02.00, A.03.00

Full Span

Changes the span to show the full frequency range of the spectrum analyzer.

Key Path	SPAN X Scale
Mode	SA, WCDMA, C2K, WiMAX OFDMA, TD-SCDMA, 1xEVDO, DVB-T/H, DTMB (CTTB), ISDB-T, CMMB, LTE, LTETDD, Digital Cable TV
Remote Command	<code>[:SENSe] :ACPpower:FREQuency:SPAN:FULL</code>
Example	<code>ACP:FREQ:SPAN:FULL</code>
Notes	You must be in the mode that includes ACP measurements to use this command. Use <code>:INSTrument:SElect</code> to set the mode.
Dependencies	For MSR and LTE-Advanced FDD/TDD mode, this key is blank.
Initial S/W Revision	Prior to A.02.00
Modified at S/W Revision	A.02.00, A.03.00

Last Span

Changes the span to the previous span setting. If no previous span value exists, then the span will remain unchanged.

Key Path	SPAN X Scale
Mode	SA, WCDMA, C2K, WIMAX OFDMA, TD-SCDMA, 1xEVDO, DVB-T/H, DTMB (CTTB), ISDB-T, CMMB, LTE, LTETDD, Digital Cable TV, MSR, LTEAFDD, LTEATDD
Remote Command	<code>[:SENSe] :ACPpower:FREQuency:SPAN:PREVIOUS</code>
Example	<code>ACP:FREQ:SPAN:PREV</code>
Notes	You must be in the mode that includes ACP measurements to use this command. Use <code>:INSTrument:SElect</code> to set the mode.
Initial S/W Revision	Prior to A.02.00
Modified at S/W Revision	A.02.00, A.03.00

Sweep/Control

Accesses a menu of functions that enable you to set up and control the sweep time, and source.

See Key and Command Descriptions – Sweep/Control for more information.

Key Path	Front-panel key
Initial S/W Revision	Prior to A.02.00

Sweep Time

Selects the length of time in which the spectrum analyzer sweeps the displayed frequency span. In swept spans, the sweep time varies from 1 millisecond to 2000 seconds. Additional overhead time, which impacts the sweep rate, is not calculated as part of the sweep time. In fact:

sweep rate = span/sweep time

update rate = 1/(sweep time + overhead)

sweep cycle time = sweep time + overhead

Sweep time is coupled to RBW and VBW, and is impacted by the number of sweep points, so changing those parameters may change the sweep time.

If you increase the sweep time, you increase the length of the time data captured and the number of points measured. You might need to specify a specific sweep speed to accommodate a specific condition in your transmitter. For example, you may have a burst signal and need to measure an exact portion of the burst.

Selecting a specific sweep time may result in a long measurement time since the resulting number of data points may not be the optimum 2n. Use [:SENSe]:ACP:OFFSet:LIST:SWEep:TIME to set the number of points used for measuring the offset channels for Basic and cdmaOne.

For cdma2000 and W-CDMA, this command sets the sweep time when using the sweep mode. See [:SENSe]:ACP:SWEep:TYPE

Key Path	Sweep/Control
Mode	SA, WCDMA, C2K, WIMAX OFDMA, TD-SCDMA, 1xEVDO, DVB-T/H, DTMB (CTTB), ISDB-T, CMMB, LTE, LTE-TDD, Digital Cable TV, MSR, LTEAFDD, LTEATDD
Remote Command	[:SENSe]:ACP:Power:SWEep:TIME <time> [:SENSe]:ACP:Power:SWEep:TIME? [:SENSe]:ACP:Power:SWEep:TIME:AUTO OFF ON 0 1 [:SENSe]:ACP:Power:SWEep:TIME:AUTO?
Example	ACP:SWE:TIME 50ms ACP:SWE:TIME? ACP:SWE:TIME:AUTO OFF ACP:SWE:TIME:AUTO?
Notes	This parameter is preset by Meas Method selection. Preset values are as follows:

	IBW: 29 ms IBWR: 108 ms FAST (WCDMA): 7.5 ms
Preset	SA, LTE, LTETDD, MSR: Automatically calculated WCDMA: 29 ms WIMAX OFDMA: Automatically calculated C2K: Automatically calculated TD-SCDMA: Automatically calculated 1xEVDO: Automatically calculated DVB-T/H: Automatically calculated DTMB (CTTB): Automatically calculated ISDB-T: Automatically calculated CMMB: Automatically calculated Digital Cable TV: Automatically calculated LTEAFDD, LTEATDD: Automatically calculated SA, LTE, LTETDD, MSR, LTEAFDD, LTEATDD: ON WCDMA: OFF C2K: OFF (method IBW) WIMAX OFDMA: ON TD-SCDMA: ON DVB-T/H: ON DTMB (CTTB): ON ISDB-T: ON CMMB: ON Digital Cable TV: ON
State Saved	Saved in instrument state.
Min	1 ms
Max	4000 s
Initial S/W Revision	Prior to A.02.00
Modified at S/W Revision	A.02.00, A.03.00

Sweep Setup

Accesses the sweep setup menu.

Key Path	Sweep/Control
Initial S/W Revision	Prior to A.02.00

Auto Sweep Time Rules

Switches the analyzer between normal and accuracy sweep states.

Key Path	Sweep/Control, Sweep Setup
Mode	SA, WCDMA, C2K, WIMAX OFDMA, TD-SCDMA, 1xEVDO, DVB-T/H, DTMB (CTTB), ISDB-T, CMMB, LTE, LTEFDD, Digital Cable TV, MSR, LTEAFDD, LTEATDD
Remote Command	[:SENSe] :ACPoweR :SWEep :TIME :AUTO :RULes NORMal ACCuracy [:SENSe] :ACPoweR :SWEep :TIME :AUTO :RULes ?
Example	ACP:SWE:TIME:AUTO:RUL NORM ACP:SWE:TIME:AUTO:RUL?
Notes	Set to Norm when Auto Couple is pressed or sent remotely.
Preset	SA, WCDMA, C2K, TD-SCDMA, 1xEVDO, DTMB (CTTB), LTE, LTEFDD, MSR, LTEAFDD, LTEATDD: ACCuracy WIMAX OFDMA, DVB-T/H: NORMal ISDB-T, CMMB: NORMal Digital Cable TV: NORMal
State Saved	Saved in instrument state.
Range	Norm Accy
Initial S/W Revision	Prior to A.02.00
Modified at S/W Revision	A.02.00, A.03.00

Pause

Pauses a measurement after the current data acquisition is complete. When Paused, the label on the key changes to Resume. Pressing the Resume key resumes the measurement at the point where it was paused. When Paused, pressing Restart, Single, or Cont does a Resume

See Pause/Resume for more details.

Key Path	Sweep/Control
Initial S/W Revision	Prior to A.02.00

Gate

Accesses a menu that enables you to control the gating function. The Gate functionality is used to view signals best viewed by qualifying them with other events.

Gate setup parameters are the same for all measurements – they do not change as you change measurements. Settings like these are called “Meas Global” and are unaffected by Meas Preset.

Key Path	Sweep/Control
Scope	Meas Global

Readback	The state and method of Gate, as [Off, FFT] or [On, FFT]. Note that for measurements that only support gated FFT, the method is nonetheless read back, but always as FFT.
Initial S/W Revision	Prior to A.02.00

Gate On/Off

Turns the gate function on and off.

When the Gate Function is on, the selected Gate Method is used along with the gate settings and the signal at the gate source to control the sweep system with the gate signal. Not all measurements allow every type of Gate Methods.

When Gate is on, the annunciation in the measurement bar reflects that it is on and what method is used, as seen in the following "Gate: FFT" annunciator graphic.

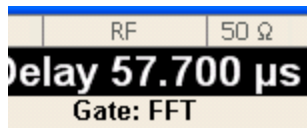

Key Path	Sweep/Control, Gate
Remote Command	[:SENSe] :SWEep:EGATe [:STATe] OFF ON 0 1 [:SENSe] :SWEep:EGATe [:STATe] ?
Example	SWE:EGAT ON SWE:EGAT?
Dependencies	When in the ACP measurement: <ul style="list-style-type: none"> • When Meas Method is RBW or FAST, this function is unavailable and the key is grayed out. • Whenever Gate is on, Meas Method, RBW or FAST is unavailable and keys for those are grayed out. • When Gate is on, Offset Res BW and Offset Video BW are ignored (if you set these values) and the measurement works as if all Offset Res BW and all Offset Video BW are coupled with the Res BW and the Video BW under the BW menu. When Gate is on, the Offset BW key in the Offset/Limit menu is grayed out.
Preset	Off LTETDD: On
State Saved	Saved in instrument state
Range	On Off
Backwards Compatibility SCPI	[:SENSe] :SWEep:TIME:GATE [:STATe] ESA compatibility
Backwards Compatibility Notes	In ESA, Trig Delay (On) and Gate (On) could not be active at the same time.. This dependency does not exist in PSA or in the X-Series.

Initial S/W Revision	Prior to A.02.00
----------------------	------------------

Gate View On/Off

Turning on Gate View in the Swept SA measurement provides a single-window gate view display..

Turning on Gate View in other measurements shows the split-screen Gate View. In these measurements, when the Gate View is on, the regular view of the current measurement traces and results are reduced vertically to about 70% of the regular height. The Zero Span window, showing the positions of the Gate, is shown between the Measurement Bar and the reduced measurement window. By reducing the height of the measurement window, some of the annotation on the Data Display may not fit and is not shown.

Key Path	Sweep/Control, Gate
Remote Command	[:SENSe] :SWEep:EGATe:VIEW ON OFF 1 0 [:SENSe] :SWEep:EGATe:VIEW?
Example	SWE:EGAT:VIEW ON turns on the gate view.
Dependencies	In the Swept SA measurement: In Gate View, the regular Acq Time key is grayed out . When pressed, the grayed out key puts up the informational message "Use Gate View Sweep Time in the Gate menu." In the other measurements: When you turn Gate View on, the lower window takes on the current state of the instrument. Upon leaving Gate View, the instrument takes on the state of the lower window. When you turn Gate View on, the upper window Acquisition Time is set to the gate view acquisition time.
Couplings	These couplings apply to the Swept SA measurement: <ul style="list-style-type: none"> • When Gate View is turned on, the instrument is set to Zero Span. • Gate View automatically turns off whenever a Span other than Zero is selected. • Gate View automatically turns off if you press the Last Span key while in Gate View, and the instrument returns to the Span it was in before entering Gate View (even if that is Zero Span). • When Gate View is turned on, the sweep time used is the gate view sweep time. This is set according to the rules in section "Gate View Setup" on page 1437 • When Gate View is turned off, Sweep Time is set to the normal Swept SA measurement sweep time. • If Gate View is on and Gate is off, then turning on Gate turns off Gate View.
Preset	OFF
State Saved	Saved in instrument state
Range	On Off
Initial S/W Revision	Prior to A.02.00

A sample of the Gate View screen in the Swept SA measurement is shown in the following graphic :

9 ACP Measurement
Sweep/Control

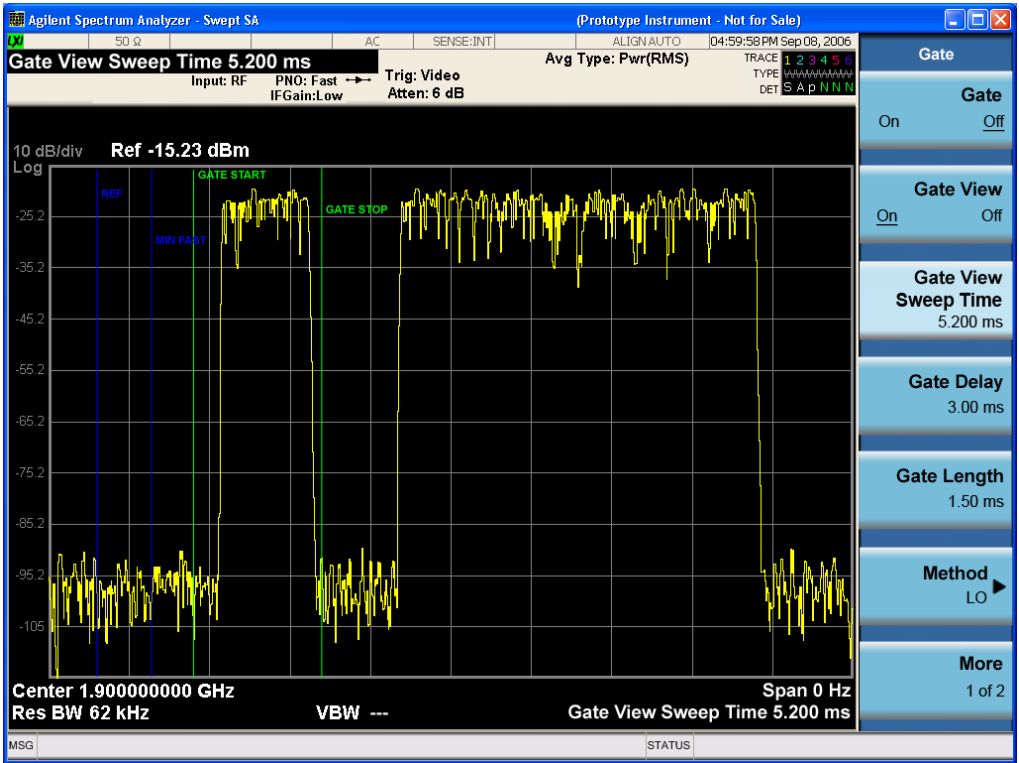

A sample of the Gate View screen in other measurements is shown in the following graphic. This example is for the ACP measurement:

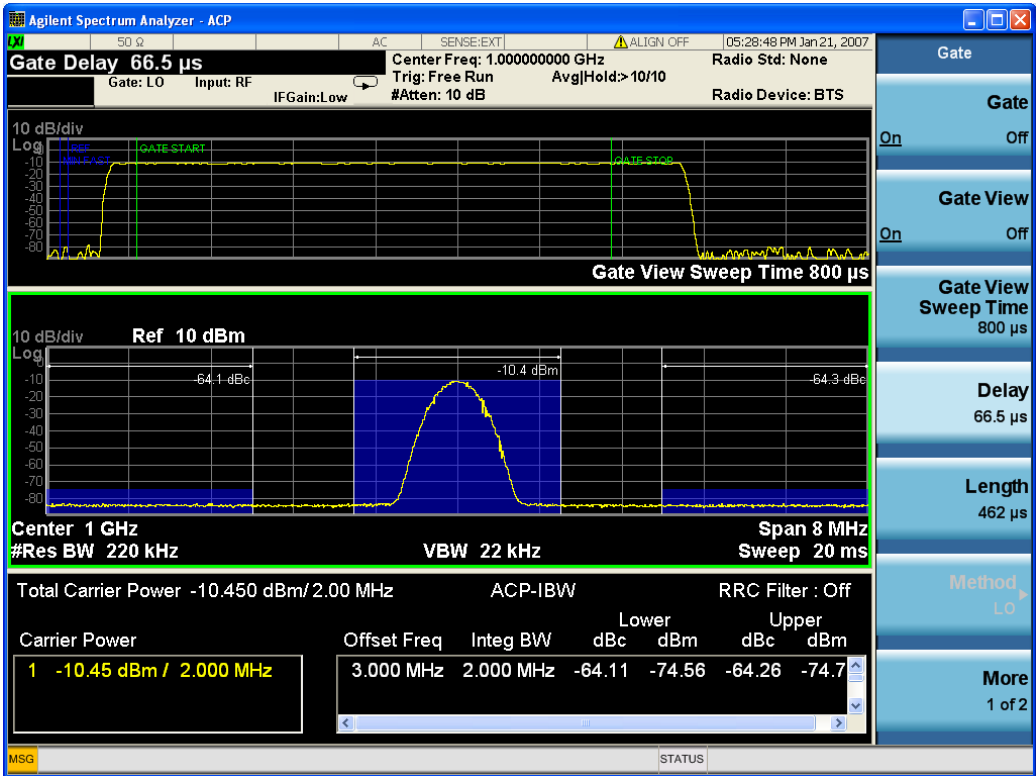

Turning Gate View off returns the analyzer to the Normal measurement view.

In the Swept SA, the normal measurement view is the single-window Swept SA view. When returning to this view, the Swept SA measurement returns to the Span it was in before entering **Gate View** (even if that is Zero Span).

The **Gate View** window is triggered from the Gate Source, with zero trigger delay. Also, when updating the **Gate View** window, the Gate itself must not operate. So it is internally shut off while the gate view window is being updated. For the Swept SA measurement, this means that the Gate is internally shut off whenever the gate view window is displayed. The measurement bar and softkeys continue to show the Trigger source for the main sweep window and give no indication that the Gate is shut off or that the Gate View window is triggered from the Gate Source.

When in **Gate View**, vertical lines are displayed in the Gate View window as follows:

- Green lines are displayed at the gate edges as follows: in Edge Gate, a line is shown for Delay and one for the end of the Gate period, defined by Length. You can adjust the position of the green lines by adjusting the gate length and the gate delay. These lines update in the Gate View window as the active function changes, even if the window is not being updated. In Gated FFT, their location is relative to the left edge of the screen.
- A blue line is displayed showing the delay reference, that is, the reference point for the Gate Delay within the Zero Span window. The blue line represents where (in time) the effective location of the gate start would be if the gate were programmed to zero delay.

-

Gate View Setup

Accesses a menu that enables you to setup parameters relevant to the Gate View

Key Path	Sweep/Control, Gate
Scope	Meas Global
Initial S/W Revision	A.10.00

Gate View Acquisition Time

Controls the acquisition time in the Gate View window. To provide an optimal view of the gate signal, the analyzer initializes Gate View Acq Time based on the current settings of Gate Delay and Gate Length.

Key Path	Sweep/Control, Gate, Gate View Setup
Remote Command	[:SENSe] :SWEep:EGATe:TIME <time> [:SENSe] :SWEep:EGATe:TIME?
Example	SWE:EGAT:TIME 500 ms
Dependencies	Gate View Acquisition Time is initialized: <ul style="list-style-type: none"> • On Preset (after initializing delay and length). • Every time the Gate Method is set/changed. 1. Compute the location of the "gate stop" line, which you know is at time $t = t_{min} + \text{GateDelay} +$

GateLength.	
Preset	519.3 μ s WiMAX OFDMA: 5 ms GSM/EDGE: 1 ms
State Saved	Saved in instrument state
Min	100 ns
Max	6000 s
Initial S/W Revision	Prior to A.02.00

Gate View Start Time

Controls the time at the left edge of the Gate View.

Key Path	Sweep/Control, Gate, Gate View Setup
Remote Command	[:SENSe] :SWEep:EGATe:VIEW:STARt <time> [:SENSe] :SWEep:EGATe:VIEW:STARt?
Example	SWE:EGAT:VIEW:STAR 10ms
Notes	Units of time are required or no units; otherwise an invalid suffix error message will be generated. See error -131.
Preset	0 ms
State Saved	Saved in instrument state
Min	0
Max	500 ms
Initial S/W Revision	A.10.00

Gate Delay

Controls the length of time from the time the gate condition goes True until the gate is turned on.

Key Path	Sweep/Control, Gate
Remote Command	[:SENSe] :SWEep:EGATe:DELay <time> [:SENSe] :SWEep:EGATe:DELay?
Example	SWE:EGAT:DELay 500ms SWE:EGAT:DELay?
Notes	Units of time are required or no units; otherwise an invalid suffix error message will be generated.
Preset	57.7 μ s WiMAX OFDMA: 71 μ s GSM/EDGE: 600 μ s

	WLAN: 500 us WLAN: 36 us
State Saved	Saved in instrument state
Min	0.0 us
Max	100 s
Backwards Compatibility SCPI	[:SENSe]:SWEep:TIME:GATE:DELay ESA compatibility
Initial S/W Revision	Prior to A.02.00

Gate Length

Controls the length of time that the gate is on after it opens.

Key Path	Sweep/Control, Gate
Remote Command	[:SENSe]:SWEep:EGATe:LENGth <time> [:SENSe]:SWEep:EGATe:LENGth?
Example	SWE:EGAT:LENG 1 SWE:EGAT:LENG?
Notes	Units of time are required or no units; otherwise an invalid suffix error message will be generated.
Preset	461.6 us WiMAX OFDMA: 50 us GSM/EDGE: 200 us WLAN: 1.54 ms WLAN: 32 us
State Saved	Saved in instrument state
Min	100 ns
Max	5 s
Backwards Compatibility SCPI	[:SENSe]:SWEep:TIME:GATE:LENGth ESA compatibility
Initial S/W Revision	Prior to A.02.00

Gate Source

The menus under the Gate Source key are the same as those under the Trigger key, with the exception that neither Free Run nor Video are available as Gate Source selections. However, a different SCPI command is used to select the Gate Source (see table below) because you may independently set the Gate Source and the Trigger Source.

Any changes to the settings in the setup menus under each Gate Source selection key (for example: Trigger Level, Trigger Delay, etc.) also affect the corresponding settings under the Trigger menu keys. The SCPI commands used for these are the same for Trigger and Gate, since there is only one setting which affects both Gate and Trigger. Example: to set the Trigger Level for External 1 you use the command :TRIG:EXT1:LEV regardless of whether you are using External 1 as a Trigger Source or a Gate Source.

Key Path	Sweep/Control, Gate
Remote Command	[:SENSe] :SWEep:EGATe:SOURce EXTernal1 EXTernal2 LINE FRAME RFBurst [:SENSe] :SWEep:EGATe:SOURce?
Dependencies	In some models, there is no second External input. In these models, the External 2 key is blanked and the EXTernal2 parameter will generate a "Hardware missing; Not available for this model number" error.
Preset	EXTernal 1 GSM/EDGE, MSR: FRAME LTETDD: EXTernal 1When Direction is Downlink, FRAME when Direction is Uplink.
Initial S/W Revision	Prior to A.02.00
Modified at S/W Revision	A.03.00, A.14.00

Video (IF Envelope)

Pressing this key, when it is not selected, selects the video signal as the trigger. The Video trigger condition is met when the video signal (the filtered and detected version of the input signal, including both RBW and VBW filtering) crosses the video trigger level.

NOTE

When the detector selected for all active traces is the average detector, the video signal for triggering does not include any VBW filtering.

The video trigger level is shown as a labeled line on the display. The line is displayed as long as video is the selected trigger source.

Pressing this key, when it is already selected, accesses the video trigger setup functions.

Key Path	Trigger
Example	TRIG:SOUR VID Swept SA measurement TRIG:< meas > :SOUR VID Measurements other than Swept SA
Notes	Log Plot and Spot Frequency measurements do not support Video Trigger
Dependencies	Video trigger is allowed in average detector mode.
State Saved	Saved in instrument state
Status Bits/OPC dependencies	The Status Operation Register bit 5 "Waiting for Trigger" is set at the same time as the Sweeping or Measuring bit is set. It is cleared when the trigger actually occurs (that is, after the trigger event occurs and all the applicable trigger criteria have been met). A corresponding pop-up message ("Waiting for trigger") is generated if no trigger signal appears after approximately 2 sec. This message goes away when a trigger signal appears.

Backwards Compatibility Notes	In the past, the Average detector was not available when Video triggering was on, and consequently, functions that set the detector to average (such as Marker Noise or Band/Intvl Power) were not available when the video trigger was on. Similarly, Video triggering was not available when the detector was Average. In the X-Series, these restrictions are removed.
Initial S/W Revision	Prior to A.02.00

Trigger Level

Sets a level for the video signal trigger. When the video signal crosses this level, with the chosen slope, the trigger occurs. This level is displayed with a horizontal line only if **Video** is the selected trigger source.

Key Path	Trigger, Video
Remote Command	:TRIGger[:SEquence]:VIDeo:LEVel <ampl> :TRIGger[:SEquence]:VIDeo:LEVel?
Example	TRIG:VID:LEV -40 dBm
Notes	<p>When sweep type = FFT, the video trigger uses the amplitude envelope in a bandwidth wider than the FFT width as a trigger source. This might often be useful, but does not have the same relationship between the displayed trace and the trigger level as in swept triggering.</p> <p>Amplitude Corrections are not taken into account by the Video Trig Level. For example, if you have given yourself effective gain with an amplitude correction factor, the Video Trigger will not fire until you have dropped the trigger line that far below the displayed signal level, rather than simply dropping it down to the displayed signal level.</p> <p>Note that other corrections, specifically External Gain and Ref Level Offset, modify the actual trace data as it is taken and therefore ARE taken into account by Trig Level.</p>
Couplings	This same level is used for the Video trigger source in the Trigger menu and for the Video selection in the Gate Source menu.
Preset	Set the Video Trigger Level -25 dBm on Preset. When the Video Trigger Level becomes the active function, if the value is off screen, set it to either the top or bottom of screen, depending on which direction off screen it was.
State Saved	Saved in instrument state
Min	-170 dBm
Max	+30 dBm
Default Unit	Depends on the current selected Y axis unit
Backwards Compatibility SCPI	:TRIGger[:SEquence]:IF:LEVel :TRIGger[:SEquence]:IF:LEVel?
Backwards Compatibility Notes	This alias is provided for backward compatibility with VSA/PSA comms apps.
Initial S/W Revision	Prior to A.02.00

Trig Slope

Controls the trigger polarity. It is set positive to trigger on a rising edge and negative to trigger on a falling edge.

Key Path	Trigger, Video
Remote Command	:TRIGger[:SEquence]:VIDeo:SLOPe POSitive NEGative :TRIGger[:SEquence]:VIDeo:SLOPe?
Example	TRIG:VID:SLOP NEG
Preset	POSitive
State Saved	Saved in instrument state
Backwards Compatibility SCPI	:TRIGger[:SEquence]:IF:SLOPe NEGative POSitive :TRIGger[:SEquence]:IF:SLOPe? For backward compatibility with VSA/PSA comms apps
Backwards Compatibility Notes	The legacy :TRIGger[:SEquence]:SLOPe command affects the slopes for the VID, LINE, EXT1, EXT2, and RFB triggers.
Initial S/W Revision	Prior to A.02.00

Remote Command	:TRIGger[:SEquence]:SLOPe POSitive NEGative :TRIGger[:SEquence]:SLOPe?
Example	TRIG:SLOP NEG
Preset	POSitive
State Saved	Saved in instrument state
Backwards Compatibility Notes	In ESA/PSA, the Trigger Slope was global to all triggers. In the X-Series, the slope can be set individually for each Trigger Source. For backward compatibility, the global SLOPe command updates all instances of trigger slope (VID, LINE, EXT1, EXT2, TV, RFB). The query returns the trigger slope setting of the currently selected trigger source.
Initial S/W Revision	Prior to A.02.00

External 1

Pressing this key, when it is not selected, selects an external input signal as the trigger. A new sweep/measurement will start when the external trigger condition is met using the external 1 input connector on the rear panel.

Pressing this key, when it is already selected, accesses the external 1 trigger setup menu.

Key Path	Trigger
Example	TRIG:SOUR EXT1 Swept SA measurement TRIG:<meas>:SOUR EXT1 Measurements other than Swept SA
Dependencies	Grayed out if in use by Point Trigger in the Source Setup menu. Forced to Free Run if already selected and Point Trigger is set to External 1.

State Saved	Saved in instrument state
Status Bits/OPC dependencies	The Status Operation Register bit 5 "Waiting for Trigger" is set at the same time as the Sweeping or Measuring bit is set. It is cleared when the trigger actually occurs (that is, after the trigger event occurs and all the applicable trigger criteria have been met). A corresponding pop-up message ("Waiting for trigger") is generated if no trigger signal appears after approximately 2 sec. This message goes away when a trigger signal appears.
Initial S/W Revision	Prior to A.02.00

Trigger Level

Sets the value where the external 1 trigger input will trigger a new sweep/measurement.

Key Path	Trigger, External 1
Remote Command	:TRIGger[:SEquence]:EXTernal1:LEVel <level> :TRIGger[:SEquence]:EXTernal1:LEVel?
Example	TRIG:EXT1:LEV 0.4 V
Couplings	This same level is used for the Ext1 trigger source in the Trigger menu, for the Ext1 selection in the Periodic Timer sync source (in the Trigger menu and in the Gate Source menu), and also for the Ext1 selection in the Gate Source menu.
Preset	1.2 V
State Saved	Saved in instrument state
Min	-3.5V
Max	3.5V
Default Unit	V
Backwards Compatibility SCPI	:TRIGger[:SEquence]:EXTernal:LEVel For backward compatibility, the parameter EXTernal is mapped to EXTernal1
Backwards Compatibility SCPI	:TRIGger[:SEquence]:FRAMe:EXTernal1:LEVel
Initial S/W Revision	Prior to A.02.00

Trig Slope

Controls the trigger polarity. It is set positive to trigger on a rising edge and negative to trigger on a falling edge.

Key Path	Trigger, External 1
Remote Command	:TRIGger[:SEquence]:EXTernal1:SLOPe POSitive NEGative :TRIGger[:SEquence]:EXTernal1:SLOPe?

Example	TRIG:EXT1:SLOP NEG
Couplings	This same slope is used in the Ext1 selection for the trigger source in the Trigger menu and for the period timer sync source (in the Trigger menu and in the Gate Source menu).
Preset	POSitive
State Saved	Saved in instrument state
Backwards Compatibility SCPI	:TRIGger[:SEquence]:EXTernal:SLOPe For backward compatibility, the parameter EXTernal is mapped to EXTernal1
Backwards Compatibility SCPI	:TRIGger[:SEquence]:FRAMe:EXTernal1:SLOPe
Backwards Compatibility Notes	The legacy :TRIGger[:SEquence]:SLOPe command affects the slopes for the VID, LINE, EXT1, EXT2, and RFB triggers.
Initial S/W Revision	Prior to A.02.00

Zero Span Delay Comp On/Off

In zero span, there is a natural delay in the signal path, which comes from the RBW filter. This is usually desirable, as it allows you to trigger on events and also see those events, because the signal is delayed from the trigger event. However, in some cases it is desirable to eliminate this delay, so that trigger events line up exactly with the zero time point in zero span. You can use the Zero Span Delay Comp On/Off feature to enable or disable zero span delay compensation.

Key Path	Trigger, External 1
Remote Command	:TRIGger[:SEquence]:EXTernal1:DELay:COMPensation OFF ON 0 1 :TRIGger[:SEquence]:EXTernal1:DELay:COMPensation?
Example	TRIG:EXT1:DEL:COMP ON
Dependencies	No effect except in zero-span, but not locked out in nonzero spans. Blanked in modes that do not support zero-span measurements. If the SCPI command is sent when the key is blanked, an error is returned: -221, "Settings conflict; Feature not supported for this measurement" In analyzers shipping N9060A, this feature requires N9060A-7FP.
Preset	OFF
State Saved	Saved in instrument state
Initial S/W Revision	A.11.00

External 2

Pressing this key, when it is not selected, selects an external input signal as the trigger. A new sweep/measurement will start when the external trigger condition is met using the external 2 input connector. The external trigger 2 input connector is on the rear panel.

Pressing this key, when it is already selected, accesses the external 2 trigger setup menu.

Key Path	Trigger
Example	TRIG:SOUR EXT2 Swept SA measurement TRIG:<meas>:SOUR EXT2 Measurements other than Swept SA
Dependencies	In some models, there is no second External input. In these models, the External 2 key is blanked and the EXTernal2 parameter will generate a "Hardware missing; Not available for this model number" message. Grayed out if in use by Point Trigger in the Source Setup menu. Forced to Free Run if already selected and Point Trigger is set to External 2.
State Saved	Saved in instrument state
Status Bits/OPC dependencies	The Status Operation Register bit 5 "Waiting for Trigger" is set at the same time as the Sweeping or Measuring bit is set. It is cleared when the trigger actually occurs (that is, after the trigger event occurs and all the applicable trigger criteria have been met). A corresponding pop-up message ("Waiting for trigger") is generated if no trigger signal appears after approximately 2 sec. This message goes away when a trigger signal appears.
Initial S/W Revision	Prior to A.02.00
Modified at S/W Revision	A.03.00

Trigger Level

Sets the value where the external 2 trigger input will trigger a new sweep/measurement.

Key Path	Trigger, External 2
Remote Command	:TRIGger[:SEquence]:EXTernal2:LEVel :TRIGger[:SEquence]:EXTernal2:LEVel?
Example	TRIG:EXT2:LEV 1.1 V
Couplings	This same level is used for the Ext2 trigger source in the Trigger menu, for the Ext2 selection in the Periodic Timer sync source (in the Trigger menu and in the Gate Source menu), and also for the Ext2 selection in the Gate Source menu.
Preset	1.2 V
State Saved	Saved in instrument state
Min	-3.5V
Max	3.5V
Default Unit	V
Backwards Compatibility SCPI	:TRIGger[:SEquence]:FRAMe:EXTernal2:LEVel
Initial S/W Revision	Prior to A.02.00

Trig Slope

Controls the trigger polarity. It is set positive to trigger on a rising edge and negative to trigger on a falling edge.

Key Path	Trigger, External 2
Remote Command	:TRIGger[:SEquence]:EXternal2:SLOPe POSitive NEGative :TRIGger[:SEquence]:EXternal2:SLOPe?
Example	TRIG:EXT2:SLOP NEG
Couplings	This same slope is used in the Ext2 selection for the trigger source in the Trigger menu and for the period timer sync source (in the Trigger menu and in the Gate Source menu).
Preset	POSitive
State Saved	Saved in instrument state
Backwards Compatibility SCPI	:TRIGger[:SEquence]:FRAMe:EXternal2:SLOPe
Backwards Compatibility Notes	The legacy :TRIGger[:SEquence]:SLOPe command affects the slopes for the VID, LINE, EXT1, EXT2, and RFB triggers.
Initial S/W Revision	Prior to A.02.00

Zero Span Delay Comp On/Off

In zero span, there is a natural delay in the signal path, which comes from the RBW filter. This is usually desirable, as it allows you to trigger on events and also see those events, because the signal is delayed from the trigger event. However, in some cases it is desirable to eliminate this delay, so that trigger events line up exactly with the zero time point in zero span. You can use the Zero Span Delay Comp On/Off feature to enable or disable zero span delay compensation.

Key Path	Trigger, External 2
Remote Command	:TRIGger[:SEquence]:EXternal2:DELAy:COMPensation OFF ON 0 1 :TRIGger[:SEquence]:EXternal2:DELAy:COMPensation?
Example	TRIG:EXT2:DEL:COMP ON
Dependencies	No effect except in zero-span, but not locked out in nonzero spans. Blanked in modes that do not support zero-span measurements. If the SCPI command is sent when the key is blanked, an error is returned: -221, "Settings conflict; Feature not supported for this measurement" In analyzers shipping N9060A, this feature requires N9060A-7FP.
Preset	OFF
State Saved	Saved in instrument state
Initial S/W Revision	A.11.00

RF Burst

Pressing this key, when it is not selected, selects the RF Burst as the trigger. A new sweep/measurement will start when an RF burst envelope signal is identified from the signal at the RF Input connector. Pressing this key, when it is already selected, accesses the RF Burst trigger setup menu.

In some models, a variety of burst trigger circuitry is available, resulting in various available burst trigger bandwidths. The analyzer automatically chooses the appropriate trigger path based on the hardware configuration and other settings of the analyzer.

Key Path	Trigger
Example	TRIG:SOUR RFB Swept SA measurement TRIG:<meas>:SOUR RFB Measurements other than Swept SA
State Saved	Saved in instrument state
Status Bits/OPC dependencies	The Status Operation Register bit 5 "Waiting for Trigger" is set at the same time as the Sweeping or Measuring bit is set. It is cleared when the trigger actually occurs (that is, after the trigger event occurs and all the applicable trigger criteria have been met). A corresponding pop-up message ("Waiting for trigger") is generated if no trigger signal appears after approximately 2 sec. This message goes away when a trigger signal appears.
Backwards Compatibility Notes	The legacy command: :TRIGger[:SEQuence]:RFBurst:FSElectivity[:STATe] OFF ON 0 1 is not supported in the X-Series, as the hardware to do Frequency Selective burst triggers does not exist in X-Series.
Initial S/W Revision	Prior to A.02.00
Modified at S/W Revision	A.04.00

Absolute Trigger Level

Sets the absolute trigger level for the RF burst envelope.

When using the External Mixing path, the Absolute Trigger Level is uncalibrated because the factory default was set to accommodate the expected IF levels for the RF path.

Key Path	Trigger, RF Burst
Scope	Meas Global
Remote Command	:TRIGger[:SEQuence]:RFBurst:LEVel:ABSolute <ampl> :TRIGger[:SEQuence]:RFBurst:LEVel:ABSolute?
Example	TRIG:RFB:LEV:ABS 10 dBm sets the trigger level of the RF burst envelope signal to the absolute level of 10 dBm
Notes	Sending this command does not switch the setting from relative to absolute; to switch it you need to send the :TRIGger[:SEQuence]:RFBurst:LEVel:TYPE command, below. Amplitude Corrections are not taken into account by the Absolute Trigger Level. For example, if you have given yourself effective gain with an amplitude correction factor, the Absolute Trigger will not fire until you have set the trigger level that far below the displayed signal level, rather than simply to

	the displayed signal level. This is only true for Amplitude Corrections, not External Gain or Ref Level Offset functions. If mode is Bluetooth, the default value is -50 dBm.
Couplings	This same level is used for the RF Burst trigger source in the Trigger menu, for the RF Burst selection in the Periodic Timer sync source (in the Trigger menu and in the Gate Source menu), and also for the RF Burst selection in the Gate Source menu
Preset	-20 dBm
State Saved	Saved in instrument state
Min	-200 dBm
Max	100 dBm
Default Unit	depends on the current selected Y-Axis unit
Backwards Compatibility SCPI	:TRIGger[:SEquence]:FRAME:RFBurst:LEVel:ABSolute
Initial S/W Revision	Prior to A.02.00
Modified at S/W Revision	A.04.00

Key Path	Trigger, RF Burst
Remote Command	:TRIGger[:SEquence]:RFBurst:LEVel:TYPE ABSolute RELative :TRIGger[:SEquence]:RFBurst:LEVel:TYPE?
Example	TRIG:RFB:LEV:TYPE REL sets the trigger level type of the RF burst trigger to Relative.
Preset	ABSolute
State Saved	Saved in instrument state
Initial S/W Revision	Prior to A.02.00
Modified at S/W Revision	A.04.00

Relative Trigger Level

Sets the relative trigger level for the RF burst envelope.

In some models, the relative burst trigger function is implemented in hardware. In other models, without the advanced triggering hardware required, the relative burst trigger function is implemented in software in some measurements, and is unavailable in other measurements.

When implemented in software, the relative RF Burst trigger function is implemented as follows:

1. The measurement starts with the absolute RF Burst trigger setting. If it cannot get a trigger with that level, auto trigger fires and the acquisition starts anyway. After the acquisition, the measurement searches for the peak in the acquired waveform and saves it.

2. Now, in the next cycle of the measurement, the measurement determines a new absolute RF Burst level based on the peak value from the first measurement and the Relative RF Burst Trigger Level (always 0 or negative dB) set by the user. The following formula is used:
 3. absolute RF Burst level = peak level of the previous acquisition + relative RF Burst level
 4. If the new absolute RF Burst level differs from the previous by more than 0.5 dB, the new level is sent to the hardware; otherwise it is not updated (to avoid slowing down the acquisition)
- Steps 2 and 3 repeat for subsequent measurements.

Key Path	Trigger, RF Burst
Scope	Meas Global
Remote Command	:TRIGger[:SEquence]:RFBurst:LEVel:RELative <rel_ampl> :TRIGger[:SEquence]:RFBurst:LEVel:RELative?
Example	TRIG:RFB:LEV:REL -10 dB sets the trigger level of the RF burst envelope signal to the relative level of -10 dB
Notes	Sending this command does not switch the setting from absolute to relative; to switch it you need to send the :TRIGger[:SEquence]:RFBurst:LEVel:TYPE command, above. The relative trigger level is not available in some measurements. In those measurements the RELative parameter, and the :TRIGger[:SEquence]:RFBurst:LEVel:TYPE command (above), will generate an error if sent.
Dependencies	This key is grayed out and Absolute Trigger Level selected if the required hardware is not present in your analyzer and the current measurement does not support Relative triggering.
Preset	-6 dB GSM: -25 dB
State Saved	Saved in instrument state
Min	-45 dB
Max	0 dB
Default Unit	dB or dBc
Backwards Compatibility SCPI	:TRIGger[:SEquence]:RFBurst:LEVel This legacy command is aliased to :TRIGger[:SEquence]:RFBurst:LEVel:RELative because the PSA had ONLY relative burst triggering
Initial S/W Revision	Prior to A.02.00
Modified at S/W Revision	A.04.00

Trigger Slope

It is set positive to trigger on a rising edge and negative to trigger on a falling edge.

Key Path	Trigger, RF Burst
Remote Command	:TRIGger[:SEquence]:RFBurst:SLOPe Positive NEGative :TRIGger[:SEquence]:RFBurst:SLOPe?

Example	TRIG:RFB:SLOP NEG
Couplings	This same slope is used in the RF Burst selection for the trigger source in the Trigger menu and for the period timer sync source (in the Trigger menu and in the Gate Source menu).
Preset	POSitive
State Saved	Saved in instrument state
Backwards Compatibility SCPI	:TRIGger[:SEQuence]:FRAMe:RFBurst:SLOPe
Backwards Compatibility Notes	The legacy :TRIGger[:SEQuence]:SLOPe command affects the slopes for the VID, LINE, EXT1, EXT2, and RFB triggers.
Initial S/W Revision	Prior to A.02.00

Periodic Timer (Frame Trigger)

Pressing this key, when it is not selected, selects the internal periodic timer signal as the trigger. Triggering occurrences are set by the **Period** parameter, which is modified by the **Sync Source** and **Offset**. Pressing this key, when it is already selected, accesses the periodic timer trigger setup functions.

If you do not have a sync source selected (it is Off), then the internal timer will not be synchronized with any external timing events.

Key Path	Trigger
Example	TRIG:SOUR FRAM Swept SA measurement TRIG:<meas>:SOUR FRAM Measurements other than Swept SA
State Saved	Saved in instrument state
Readback	[Sync: <value of Sync Source>], for example, [Sync: External 1]
Status Bits/OPC dependencies	The Status Operation Register bit 5 "Waiting for Trigger" is set at the same time as the Sweeping or Measuring bit is set. It is cleared when the trigger actually occurs (that is, after the trigger event occurs and all the applicable trigger criteria have been met). A corresponding pop-up message ("Waiting for trigger") is generated if no trigger signal appears after approximately 2 sec. This message goes away when a trigger signal appears.
Initial S/W Revision	Prior to A.02.00

Periodic Timer Triggering:

This feature selects the internal periodic timer signal as the trigger. Trigger occurrences are set by the **Periodic Timer** parameter, which is modified by the **Sync Source** and **Offset**.

The figure below shows the action of the periodic timer trigger. Before reviewing the figure, we'll explain some uses for the periodic trigger.

A common application is measuring periodic burst RF signals for which a trigger signal is not easily available. For example, we might be measuring a TDMA radio which bursts every 20 ms. Let's assume that the 20 ms period is very consistent. Let's also assume that we do not have an external trigger source

available that is synchronized with the period, and that the signal-to-noise ratio of the signal is not high enough to provide a clean RF burst trigger at all of the analysis frequencies. For example, we might want to measure spurious transmissions at an offset from the carrier that is larger than the bandwidth of the RF burst trigger. In this application, we can set the Periodic Timer to a 20.00 ms period and adjust the offset from that timer to position our trigger just where we want it. If we find that the 20.00 ms is not exactly right, we can adjust the period slightly to minimize the drift between the period timer and the signal to be measured.

A second way to use this feature would be to use **Sync Source** temporarily, instead of **Offset**. In this case, we might tune to the signal in a narrow span and use the RF Burst trigger to synchronize the periodic timer. Then we would turn the sync source off so that it would not miss-trigger. Miss-triggering can occur when we are tuned so far away from the RF burst trigger that it is no longer reliable.

A third example would be to synchronize to a signal that has a reference time element of much longer period than the period of interest. In some CDMA applications, it is useful to look at signals with a short periodicity, by synchronizing that periodicity to the "even-second clock" edge that happens every two seconds. Thus, we could connect the even-second clock trigger to Ext1 and use then Ext1 as the sync source for the periodic timer.

The figure below illustrates this third example. The top trace represents the even-second clock. It causes the periodic timer to synchronize with the leading edge shown. The analyzer trigger occurs at a time delayed by the accumulated offset from the period trigger event. The periodic timer continues to run, and triggers continue to occur, with a periodicity determined by the analyzer time base. The timer output (labeled "late event") will drift away from its ideal time due to imperfect matching between the time base of the signal being measured and the time base of the analyzer, and also because of imperfect setting of the period parameter. But the synchronization is restored on the next even-second clock event. ("Accumulated offset" is described in the in the **Offset** function section.)

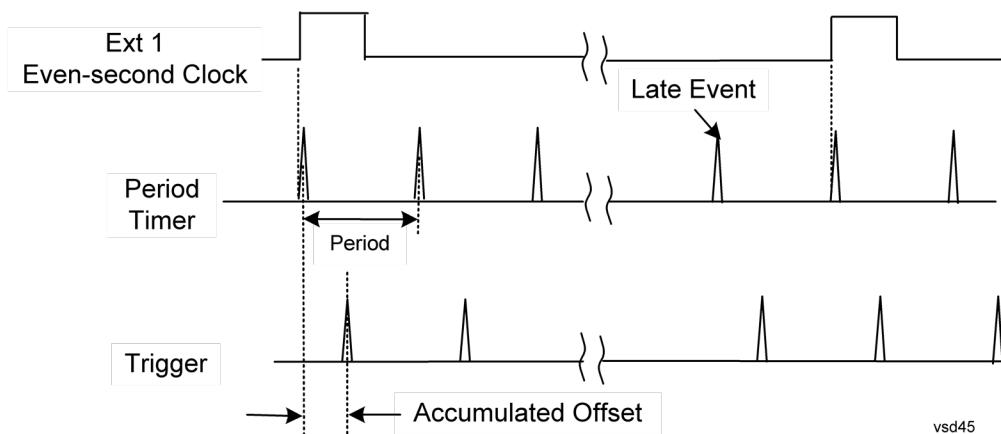

Period

Sets the period of the internal periodic timer clock. For digital communications signals, this is usually set to the frame period of your current input signal. In the case that sync source is not set to OFF, and the external sync source rate is changed for some reason, the periodic timer is synchronized at the every external synchronization pulse by resetting the internal state of the timer circuit.

Key Path	Trigger, Periodic Timer
Remote Command	:TRIGGER[:SEQUENCE]:FRAME:PERIOD <time>

	:TRIGger[:SEquence]:FRAMe:PERiod?
Example	TRIG:FRAM:PER 100 ms
Dependencies	The invalid data indicator turns on when the period is changed, until the next sweep/measurement completes.
Couplings	The same period is used in the Gate Source selection of the period timer.
Preset	20 ms GSM: 4.615383
State Saved	Saved in instrument state
Min	100.000 ns
Max	559.0000 ms
Default Unit	S
Initial S/W Revision	Prior to A.02.00

Offset

Adjusts the accumulated offset between the periodic timer events and the trigger event. Adjusting the accumulated offset is different than setting an offset, and requires explanation.

The periodic timer is usually not synchronized with any external events, so the timing of its output events has no absolute meaning. Since the timing relative to external events (RF signals) is important, you need to be able to adjust (offset) it. However, you have no direct way to see when the periodic timer events occur. All that you can see is the trigger timing. When you want to adjust the trigger timing, you will be changing the internal offset between the periodic timer events and the trigger event. Because the absolute value of that internal offset is unknown, we will just call that the accumulated offset. Whenever the Offset parameter is changed, you are changing that accumulated offset. You can reset the displayed offset using Reset Offset Display. Changing the display does not change the value of the accumulated offset, and you can still make additional changes to accumulated offset.

To avoid ambiguity, we define that an increase in the "offset" parameter, either from the knob or the SCPI adjust command, serves to delay the timing of the trigger event.

Key Path	Trigger, Periodic Timer
Remote Command	:TRIGger[:SEquence]:FRAMe:OFFSet <time> :TRIGger[:SEquence]:FRAMe:OFFSet?
Example	TRIG:FRAM:OFFS 1.2 ms
Notes	The front panel interface (for example, the knob), and this command, adjust the accumulated offset, which is shown on the active function display. However, the actual amount sent to the hardware each time the offset is updated is the delta value, that is, the current accumulated offset value minus the previous accumulated offset value. Note that the accumulated offset value is essentially arbitrary; it represents the accumulated offset from the last time the offset was zeroed (with the Reset Offset Display key). Note that this command does not change the period of the trigger waveform. Note also that Offset is used only when the sync source is set to OFF, otherwise delay is used, see section " Trig Delay " on page 280 .

	An increase in the "offset" parameter, either from the knob or the SCPI adjust command, serves to delay the timing of the trigger event.
Notes	When the SCPI command is sent the value shown on the key (and the Active Function, if this happens to be the active function) is updated with the new value. However, the actual amount sent to the hardware is the delta value, that is, the current accumulated offset value minus the previous accumulated offset value. The SCPI query simply returns the value currently showing on the key.
Dependencies	The invalid data indicator turns on when the offset is changed, until the next sweep/measurement completes.
Couplings	The same offset is used in the Gate Source selection of the period timer.
Preset	0 s
State Saved	Saved in instrument state
Min	-10.000 s
Max	10.000 s
Default Unit	S
Initial S/W Revision	Prior to A.02.00

Offset Adjust (Remote Command Only)

This remote command does not work at all like the related front panel keys. This command lets you advance the phase of the frame trigger by the amount you specify.

It does not change the period of the trigger waveform. If the command is sent multiple times, it advances the phase of the frame trigger an additional amount each time it is sent. Negative numbers are permitted.

Remote Command	:TRIGger[:SEquence]:FRAMe:ADJust <time>
Example	TRIG:FRAM:ADJ 1.2 ms
Notes	Note also that Offset is used only when the sync source is set to OFF, otherwise delay is used, see section " Trig Delay " on page 280 An increase in the "offset" parameter, either from the knob or the SCPI adjust command, serves to delay the timing of the trigger event.
Notes	The front panel interface (for example, the knob) and the :TRIG:FRAM:OFFS command adjust the accumulated offset, which is shown on the active function display. However, the actual amount sent to the hardware is the delta value, that is, the current offset value minus the previous offset value. When the SCPI command is sent the value shown on the key (and the Active Function, if this happens to be the active function) is updated by increasing it (or decreasing it if the value sent is negative) by the amount specified in the SCPI command. This is a "command only" SCPI command, with no query.
Dependencies	The invalid data indicator turns on when the offset is changed, until the next sweep/measurement completes.
Couplings	The same offset is used in the Gate Source selection of the period timer.
Preset	0 s

State Saved	Saved in instrument state
Min	-10.000 s
Max	10.000 s
Default Unit	S
Initial S/W Revision	Prior to A.02.00

Reset Offset Display

Resets the value of the periodic trigger offset display setting to 0.0 seconds. The current displayed trigger location may include an offset value defined with the Offset key. Pressing this key redefines the currently displayed trigger location as the new trigger point that is 0.0 s offset. The Offset key can then be used to add offset relative to this new timing.

Key Path	Trigger, Periodic Timer
Remote Command	:TRIGger[:SEquence]:FRAMe:OFFSet:DISPlay:RESet
Example	TRIG:FRAM:OFFS:DISP:RES
Initial S/W Revision	Prior to A.02.00

Sync Source

Selects a signal source for you to synchronize your periodic timer trigger to, otherwise you are triggering at some arbitrary location in the frame. Synchronization reduces the precision requirements on the setting of the period.

For convenience you may adjust the level and slope of the selected sync source in a conditional branch setup menu accessed from the Sync Source menu. Note that these settings match those in the **Trigger** and **Gate Source** menus; that is, each trigger source has only one value of level and slope, regardless of which menu it is accessed from.

Key Path	Trigger, Periodic Timer
Remote Command	:TRIGger[:SEquence]:FRAMe:SYNC EXTernal1 EXTernal2 RFBurst OFF :TRIGger[:SEquence]:FRAMe:SYNC?
Example	TRIG:FRAM:SYNC EXT2
Dependencies	In some models, there is no second External input. In these models, the External 2 key is blanked and the EXTernal2 parameter will generate a "Hardware missing; Not available for this model number" message.
Preset	Off GSM/EDGE, MSR,LTE,LTETDD: RFBurst
State Saved	Saved in instrument state
Readback	The current setting is read back to this key and it is also Readback to the previous Periodic Timer trigger key.

Backwards Compatibility SCPI	:TRIGger[:SEquence]:FRAMe:SYNC EXTernal
Initial S/W Revision	Prior to A.02.00
Modified at S/W Revision	A.03.00, A.14.00

Off

Turns off the sync source for your periodic trigger. With the sync source off, the timing will drift unless the signal source frequency is locked to the analyzer frequency reference.

Key Path	Trigger, Periodic Timer, Sync Source
Example	TRIG:FRAM:SYNC OFF
Readback	Off
Initial S/W Revision	Prior to A.02.00

External 1

Pressing this key, when it is not selected, selects an external input signal as the trigger. A new sweep/measurement will start when the external trigger condition is met using the external 1 input connector on the rear panel.

Pressing this key, when it is already selected, accesses the external 1 trigger setup menu.

Key Path	Trigger
Example	TRIG:SOUR EXT1 Swept SA measurement TRIG:<meas>:SOUR EXT1 Measurements other than Swept SA
Dependencies	Grayed out if in use by Point Trigger in the Source Setup menu. Forced to Free Run if already selected and Point Trigger is set to External 1.
State Saved	Saved in instrument state
Status Bits/OPC dependencies	The Status Operation Register bit 5 "Waiting for Trigger" is set at the same time as the Sweeping or Measuring bit is set. It is cleared when the trigger actually occurs (that is, after the trigger event occurs and all the applicable trigger criteria have been met). A corresponding pop-up message ("Waiting for trigger") is generated if no trigger signal appears after approximately 2 sec. This message goes away when a trigger signal appears.
Initial S/W Revision	Prior to A.02.00

Trigger Level

Sets the value where the external 1 trigger input will trigger a new sweep/measurement.

Key Path	Trigger, External 1
Remote Command	:TRIGger[:SEquence]:EXTernal1:LEVel <level> :TRIGger[:SEquence]:EXTernal1:LEVel?
Example	TRIG:EXT1:LEV 0.4 V
Couplings	This same level is used for the Ext1 trigger source in the Trigger menu, for the Ext1 selection in the Periodic Timer sync source (in the Trigger menu and in the Gate Source menu), and also for the Ext1 selection in the Gate Source menu.
Preset	1.2 V
State Saved	Saved in instrument state
Min	-3.5V
Max	3.5V
Default Unit	V
Backwards Compatibility SCPI	:TRIGger[:SEquence]:EXTernal:LEVel For backward compatibility, the parameter EXTernal is mapped to EXTernal1
Backwards Compatibility SCPI	:TRIGger[:SEquence]:FRAMe:EXTernal1:LEVel
Initial S/W Revision	Prior to A.02.00

Trig Slope

Controls the trigger polarity. It is set positive to trigger on a rising edge and negative to trigger on a falling edge.

Key Path	Trigger, External 1
Remote Command	:TRIGger[:SEquence]:EXTernal1:SLOPe POSitive NEGative :TRIGger[:SEquence]:EXTernal1:SLOPe?
Example	TRIG:EXT1:SLOP NEG
Couplings	This same slope is used in the Ext1 selection for the trigger source in the Trigger menu and for the period timer sync source (in the Trigger menu and in the Gate Source menu).
Preset	POSitive
State Saved	Saved in instrument state
Backwards Compatibility SCPI	:TRIGger[:SEquence]:EXTernal:SLOPe For backward compatibility, the parameter EXTernal is mapped to EXTernal1
Backwards Compatibility SCPI	:TRIGger[:SEquence]:FRAMe:EXTernal1:SLOPe
Backwards Compatibility Notes	The legacy :TRIGger[:SEquence]:SLOPe command affects the slopes for the VID, LINE, EXT1, EXT2, and RFB triggers.
Initial S/W Revision	Prior to A.02.00

External 2

Pressing this key, when it is not selected, selects an external input signal as the trigger. A new sweep/measurement will start when the external trigger condition is met using the external 2 input connector. The external trigger 2 input connector is on the rear panel.

Pressing this key, when it is already selected, accesses the external 2 trigger setup menu.

Key Path	Trigger
Example	TRIG:SOUR EXT2 Swept SA measurement TRIG:<meas>:SOUR EXT2 Measurements other than Swept SA
Dependencies	In some models, there is no second External input. In these models, the External 2 key is blanked and the EXTERNAL2 parameter will generate a "Hardware missing; Not available for this model number" message. Grayed out if in use by Point Trigger in the Source Setup menu. Forced to Free Run if already selected and Point Trigger is set to External 2.
State Saved	Saved in instrument state
Status Bits/OPC dependencies	The Status Operation Register bit 5 "Waiting for Trigger" is set at the same time as the Sweeping or Measuring bit is set. It is cleared when the trigger actually occurs (that is, after the trigger event occurs and all the applicable trigger criteria have been met). A corresponding pop-up message ("Waiting for trigger") is generated if no trigger signal appears after approximately 2 sec. This message goes away when a trigger signal appears.
Initial S/W Revision	Prior to A.02.00
Modified at S/W Revision	A.03.00

Trigger Level

Sets the value where the external 2 trigger input will trigger a new sweep/measurement.

Key Path	Trigger, External 2
Remote Command	:TRIGger[:SEquence]:EXTernal2:LEVel :TRIGger[:SEquence]:EXTernal2:LEVel?
Example	TRIG:EXT2:LEV 1.1 V
Couplings	This same level is used for the Ext2 trigger source in the Trigger menu, for the Ext2 selection in the Periodic Timer sync source (in the Trigger menu and in the Gate Source menu), and also for the Ext2 selection in the Gate Source menu.
Preset	1.2 V
State Saved	Saved in instrument state
Min	-3.5V
Max	

	3.5V
Default Unit	V
Backwards Compatibility SCPI	:TRIGger[:SEquence]:FRAMe:EXTernal2:LEVel
Initial S/W Revision	Prior to A.02.00

Trig Slope

Controls the trigger polarity. It is set positive to trigger on a rising edge and negative to trigger on a falling edge.

Key Path	Trigger, External 2
Remote Command	:TRIGger[:SEquence]:EXTernal2:SLOPe POSitive NEGative :TRIGger[:SEquence]:EXTernal2:SLOPe?
Example	TRIG:EXT2:SLOP NEG
Couplings	This same slope is used in the Ext2 selection for the trigger source in the Trigger menu and for the period timer sync source (in the Trigger menu and in the Gate Source menu).
Preset	POSitive
State Saved	Saved in instrument state
Backwards Compatibility SCPI	:TRIGger[:SEquence]:FRAMe:EXTernal2:SLOPe
Backwards Compatibility Notes	The legacy :TRIGger[:SEquence]:SLOPe command affects the slopes for the VID, LINE, EXT1, EXT2, and RFB triggers.
Initial S/W Revision	Prior to A.02.00

RF Burst

Pressing this key, when it is not selected, selects the RF Burst as the trigger. A new sweep/measurement will start when an RF burst envelope signal is identified from the signal at the RF Input connector. Pressing this key, when it is already selected, accesses the RF Burst trigger setup menu.

In some models, a variety of burst trigger circuitry is available, resulting in various available burst trigger bandwidths. The analyzer automatically chooses the appropriate trigger path based on the hardware configuration and other settings of the analyzer.

Key Path	Trigger
Example	TRIG:SOUR RFB Swept SA measurement TRIG:<meas>:SOUR RFB Measurements other than Swept SA
State Saved	Saved in instrument state
Status Bits/OPC dependencies	The Status Operation Register bit 5 "Waiting for Trigger" is set at the same time as the Sweeping or Measuring bit is set. It is cleared when the trigger actually occurs (that is, after the trigger event

	occurs and all the applicable trigger criteria have been met). A corresponding pop-up message ("Waiting for trigger") is generated if no trigger signal appears after approximately 2 sec. This message goes away when a trigger signal appears.
Backwards Compatibility Notes	The legacy command: :TRIGger[:SEquence]:RFBurst:FSElectivity[:STATE] OFF ON 0 1 is not supported in the X-Series, as the hardware to do Frequency Selective burst triggers does not exist in X-Series.
Initial S/W Revision	Prior to A.02.00
Modified at S/W Revision	A.04.00

Absolute Trigger Level

Sets the absolute trigger level for the RF burst envelope.

When using the External Mixing path, the Absolute Trigger Level is uncalibrated because the factory default was set to accommodate the expected IF levels for the RF path.

Key Path	Trigger, RF Burst
Scope	Meas Global
Remote Command	:TRIGger[:SEquence]:RFBurst:LEVel:ABSolute <ampl> :TRIGger[:SEquence]:RFBurst:LEVel:ABSolute?
Example	TRIG:RFB:LEV:ABS 10 dBm sets the trigger level of the RF burst envelope signal to the absolute level of 10 dBm
Notes	Sending this command does not switch the setting from relative to absolute; to switch it you need to send the :TRIGger[:SEquence]:RFBurst:LEVel:TYPE command, below. Amplitude Corrections are not taken into account by the Absolute Trigger Level. For example, if you have given yourself effective gain with an amplitude correction factor, the Absolute Trigger will not fire until you have set the trigger level that far below the displayed signal level, rather than simply to the displayed signal level. This is only true for Amplitude Corrections, not External Gain or Ref Level Offset functions. If mode is Bluetooth, the default value is -50 dBm.
Couplings	This same level is used for the RF Burst trigger source in the Trigger menu, for the RF Burst selection in the Periodic Timer sync source (in the Trigger menu and in the Gate Source menu), and also for the RF Burst selection in the Gate Source menu
Preset	-20 dBm
State Saved	Saved in instrument state
Min	-200 dBm
Max	100 dBm
Default Unit	depends on the current selected Y-Axis unit
Backwards Compatibility SCPI	:TRIGger[:SEquence]:FRAMe:RFBurst:LEVel:ABSolute
Initial S/W Revision	Prior to A.02.00
Modified at S/W Revision	A.04.00

Key Path	Trigger, RF Burst
Remote Command	:TRIGger[:SEquence]:RFBurst:LEVel:TYPE ABSolute RELative :TRIGger[:SEquence]:RFBurst:LEVel:TYPE?
Example	TRIG:RFB:LEV:TYPE REL sets the trigger level type of the RF burst trigger to Relative.
Preset	ABSolute
State Saved	Saved in instrument state
Initial S/W Revision	Prior to A.02.00
Modified at S/W Revision	A.04.00

Trigger Slope

It is set positive to trigger on a rising edge and negative to trigger on a falling edge.

Key Path	Trigger, RF Burst
Remote Command	:TRIGger[:SEquence]:RFBurst:SLOPe POSitive NEGative :TRIGger[:SEquence]:RFBurst:SLOPe?
Example	TRIG:RFB:SLOP NEG
Couplings	This same slope is used in the RF Burst selection for the trigger source in the Trigger menu and for the period timer sync source (in the Trigger menu and in the Gate Source menu).
Preset	POSitive
State Saved	Saved in instrument state
Backwards Compatibility SCPI	:TRIGger[:SEquence]:FRAME:RFBurst:SLOPe
Backwards Compatibility Notes	The legacy :TRIGger[:SEquence]:SLOPe command affects the slopes for the VID, LINE, EXT1, EXT2, and RFB triggers.
Initial S/W Revision	Prior to A.02.00

Sync Holdoff

Sync Holdoff specifies the duration that the sync source signal must be kept false before the transition to true to be recognized as the sync timing. The periodic timer phase is aligned when the sync source signal becomes true, after the Holdoff time is satisfied.

A holdoff of 2 ms will work with most WiMAX signals, but there may be cases where the burst off duration is less than 1 ms and this value will need to be changed.

Key Path	Trigger, Periodic Timer
Remote Command	:TRIGger[:SEquence]:FRAME:SYNC:HOLDoff <time> :TRIGger[:SEquence]:FRAME:SYNC:HOLDoff?

	:TRIGger[:SEQuence]:FRAMe:SYNC:HOLDoff:STATe OFF ON 0 1
	:TRIGger[:SEQuence]:FRAMe:SYNC:HOLDoff:STATe?
Preset	On, 1.000 ms
State Saved	Saved in instrument state
Min	0 ms
Max	+500 ms
Default Unit	s
Initial S/W Revision	Prior to A.02.00

Auto/Holdoff

Opens up a menu that lets you adjust Auto Trigger and Trigger Holdoff parameters

Key Path	Trigger
Readback line	Displays a summary of the Auto Trig and Holdoff settings, in square brackets First line: Auto Off or Auto On Second Line: "HldP" followed by: <ul style="list-style-type: none"> • If Holdoff is Off, readback Off • If Holdoff On and Type = Normal, readback value • If Holdoff On and Type = Above, readback value followed by AL • If Holdoff On and Type = Below, readback value followed by BL • If Holdoff Type selection is not supported by the current measurement, Holdoff Type is always Normal
Initial S/W Revision	A.02.00

Auto Trig

Sets the time that the analyzer will wait for the trigger conditions to be met. If they are not met after that much time, then the analyzer is triggered anyway.

Key Path	Trigger, Auto/Holdoff
Remote Command	:TRIGger[:SEQuence]:ATRigger <time> :TRIGger[:SEQuence]:ATRigger? :TRIGger[:SEQuence]:ATRigger:STATe OFF ON 0 1 :TRIGger[:SEQuence]:ATRigger:STATe?
Example	TRIG:ATR:STAT ON TRIG:ATR 100 ms
Notes	The "time that the analyzer will wait" starts when the analyzer is ready for a trigger, which may be hundreds of ms after the data acquisition for a sweep is done. The "time" ends when the trigger condition is satisfied, not when the delay ends.

Preset	Off, 100 ms
State Saved	Saved in instrument state
Min	1 ms
Max	100 s
Default Unit	s
Initial S/W Revision	Prior to A.02.00

Trig Holdoff

Sets the holdoff time between triggers. When the trigger condition is satisfied, the trigger occurs, the delay begins, and the holdoff time begins. New trigger conditions will be ignored until the holdoff time expires. For a free-running trigger, the holdoff value is the minimum time between triggers.

Key Path	Trigger, Auto/Holdoff
Remote Command	:TRIGger[:SEquence]:HOLDoff <time> :TRIGger[:SEquence]:HOLDoff? :TRIGger[:SEquence]:HOLDoff:STATe OFF ON 0 1 :TRIGger[:SEquence]:HOLDoff:STATe?
Example	TRIG:HOLD:STAT ON TRIG:HOLD 100 ms
Dependencies	Unavailable if the selected Input is BBIQ. If this is the case, the key is grayed out if it is pressed the informational message "Feature not supported for this Input" is displayed. If the SCPI command is sent, the error "Settings conflict; Feature not supported for this Input" is generated.
Preset	Off, 100 ms
State Saved	Saved in instrument state
Min	0 s
Max	0.5 s
Default Unit	s
Initial S/W Revision	Prior to A.02.00

Gate Preset (Remote Command Only)

Presets the time-gated spectrum analysis capability.

This command sets gate parameter values to the ESA preset values, as follows:

Gate delay = 1 us

Gate length = 1 us

Remote Command	[:SENSe]:SWEep:TIME:GATE:PRESet ESA Compatibility
Initial S/W Revision	Prior to A.02.00

Gate Level (Remote Command Only)

Sets the gate input transition point level for the external TRIGGER inputs on the front and rear panel. This is a legacy command for PSA compatibility. It is simply an alias to the equivalent trigger level command.

Remote Command	<code>[:SENSe] :SWEep:EGATe:EXTeRnal [1] 2:LEVel <voltage></code> <code>[:SENSe] :SWEep:EGATe:EXTeRnal [1] 2:LEVel?</code>
Notes	This command is simply an alias to <code>:TRIGger[:SEQuence]:EXTeRnal[1] 2:LEVel</code> For details refer
Initial S/W Revision	Prior to A.02.00

Gate Polarity (Remote Command Only)

Sets the polarity for the gate signal. This setup is now done using the gate trigger's slope setting.

When Positive (Pos) is selected, a positive-going edge (Edge) or a high voltage (Level) will satisfy the gate condition, after the delay set with the Gate Delay key. When Negative (Neg) is selected, a negative-going edge (Edge) or a low voltage (Level) will satisfy the gate condition after the delay.

Remote Command	<code>[:SENSe] :SWEep:EGATe:POLarity NEGative POSitive</code> <code>[:SENSe] :SWEep:EGATe:POLarity?</code>
Example	<code>SWE:EGAT:POL NEG</code> <code>SWE:EGAT:POL?</code>
Preset	POSitive
State Saved	Saved in instrument state
Backwards Compatibility SCPI	<code>[:SENSe] :SWEep:TIME:GATE:POLarity</code> ESA compatibility
Initial S/W Revision	Prior to A.02.00

Remote Command	<code>[:SENSe] :SWEep:TIME:GATE:LEVel HIGH LOW</code> <code>[:SENSe] :SWEep:TIME:GATE:LEVel?</code> ESA compatibility
Preset	HIGH
Initial S/W Revision	Prior to A.02.00

Points

Sets the number of points per sweep, from 1 to 20001. The sweep time resolution setting will depend on the number of points selected.

Key Path	Sweep/Control
Mode	SA, WCDMA, C2K, WIMAX OFDMA, TD-SCDMA, 1xEVDO, DVB-T/H, DTMB (CTTB), ISDB-T, CMMB, LTE, LTEFDD, Digital Cable TV, MSR, LTEAFDD, LTEATDD
Remote Command	[:SENSe] :ACPower:SWEep:POINts <integer> [:SENSe] :ACPower:SWEep:POINts?
Example	ACP:SWE:POIN 500 ACP:SWE:POIN?
Notes	Whenever the number of sweep points changes: <ul style="list-style-type: none"> • All trace data is erased • Any traces with Update Off will also go to Display Off (like going from View to Blank in the older analyzers) • Sweep time is re-quantized • Any limit lines that are on will be updated • If averaging/hold is on, averaging/hold starts over
Couplings	Whenever the number of sweep points changes, the sweep time is re-quantized.
Preset	Others: 1001 DVB-T/H:2001 DTMB (CTTB): 2001 ISDB-T: 2001 CMMB: 2001 Digital Cable TV: 2001
State Saved	Saved in instrument state.
Min	1
Max	20001
Initial S/W Revision	Prior to A.02.00
Modified at S/W Revision	A.02.00, A.03.00

System

See "System" on page 189

Trace/Detector

Accesses a menu of functions that enable you to control the detectors for the current measurement.

Key Path	Front-panel key
Initial S/W Revision	Prior to A.02.00

Select Trace (Front-panel Only)

This key selects which trace the other parameters under the Trace/Detector menu will apply to.

Key Path	Trace/Detector
Notes	Front-panel only.
Couplings	When Meas Method is RBW or FAST, Select Trace is disabled.
Preset	1
State Saved	Saved in instrument state.
Range	1 2 3
Initial S/W Revision	Prior to A.02.00

Trace Type

Allows you to select the type of trace for the current measurement. The first page of this menu contains a selection of the trace type (Clear Write, Trace Average, Max Hold, Min Hold) for the selected trace.

Key Path	Trace/Detector
Mode	SA, WCDMA, C2K, WIMAX OFDMA, TD-SCDMA, 1xEVDO, DVB-T/H, DTMB (CTTB), ISDB-T, CMMB, LTE, LTEFDD, Digital Cable TV, MSR, LTEAFDD, LTEATDD
Remote Command	:TRACe [1] 2 3 :ACPoweR:TYPE WRITe AVERAge MAXHold MINHold :TRACe [1] 2 3 :ACPoweR:TYPE?
Example	TRAC:ACP:TYPE MINH TRAC:ACP:TYPE?
Notes	WRITe = Clear Write AVERAge = Average MAXHold = Maximum Hold MINHold = Minimum Hold
Couplings	When Detector setting is "Auto" (:SENSe]:ACPoweR:DETeCTOR:AUTO?), Detector is set to what the Radio Standard defaults states (see detector section below) for all conditions of Trace Type and for all traces. When set to Manual, all Traces use the same detector type. When Average State = Off then Trace Types AVERAge, MaxHold and MinHold will not function, since Averaging is required to be 'on' for them to operate.

	When Meas Method is RBW or FAST, Trace Type is disabled.
Preset	AVERage
State Saved	Saved in instrument state.
Initial S/W Revision	Prior to A.02.00
Modified at S/W Revision	A.02.00, A.03.00

View/Blank

Enables you to select how to view the displayed trace.

Key Path	Trace/Detector
Mode	SA,WCDMA, C2K, WIMAX OFDMA, TD-SCDMA, 1xEVDO, DVB-T/H, DTMB (CTTB), ISDB-T, CMMB, LTE, LTE-TDD, Digital Cable TV, MSR, LTEAFDD,LTEATDD
Notes	No remote control. Front panel only.
Couplings	The four states of this 1-of-N actually set two variables, Update and Display, to their four possible combinations. Trace On: Update and Display both On View: Update Off and Display On (Not implemented) Blank: Update Off and Display Off Background: Update On, Display Off (Not implemented) See tables below for detail on remote commands to control these two variables. Selecting a trace type (Clear Write, Trace Average, Max Hold, Min Hold) for a trace (pressing the key or sending the equivalent remote command) puts the trace in 'Trace On' state (Update On and Display On), even if that trace type was already selected. When Meas Method is RBW or FAST, this key is grayed out.
Preset	Trace On
State Saved	Saved in instrument state.
Range	Trace On Blank
Initial S/W Revision	Prior to A.02.00
Modified at S/W Revision	A.03.00

Key Path	Trace/Detector
Mode	WCDMA, C2K, WIMAX OFDMA, TD-SCDMA, 1xEVDO, DVB-T/H, DTMB (CTTB), ISDB-T, CMMB, LTE, LTE-TDD, Digital Cable TV, MSR, LTEAFDD,LTEATDD
Remote Command	:TRACe[1] 2 3:ACPpower:UPDate[:STATe] ON OFF 0 1 :TRACe[1] 2 3:ACPpower:UPDate[:STATe]?
Example	TRAC:ACP:UPD ON TRAC:ACP:UPD?
Couplings	Whenever you set Update to On for any trace, the Display is set to On for that trace. When Meas Method is RBW or FAST, Trace Update is disabled.
Preset	1 0 0 (On for Trace 1; Off for 2 &3)

State Saved	Saved in instrument state.
Range	0 1
Initial S/W Revision	Prior to A.02.00
Modified at S/W Revision	A.03.00
<hr/>	
Key Path	Trace/Detector
Mode	WCDMA, C2K, WIMAX OFDMA, TD-SCDMA, 1xEVDO, DVB-T/H, DTMB (CTTB), ISDB-T, CMMB, LTE, LTETDD, Digital Cable TV, MSR, LTEAFDD, LTEATDD
Remote Command	:TRACe [1] 2 3 :ACPoweR:DISPlay [:STATe] ON OFF 0 1 :TRACe [1] 2 3 :ACPoweR:DISPlay [:STATe] ?
Example	TRAC:ACP:DISP ON TRAC:ACP:DISP?
Couplings	Whenever you set Update to On for any trace, the Display is set to On for that trace. When Meas Method is RBW or FAST, Trace Display is disabled.
Preset	1 0 0 (On for Trace 1; Off for 2 &3)
State Saved	Saved in instrument state.
Range	0 1
Initial S/W Revision	Prior to A.02.00
Modified at S/W Revision	A.03.00

Detector

Accesses a menu of functions that enables you to control the detectors for the current measurement. Allows up to three (3) traces, but each use the same detector type choice. The following choices are available:

- Auto—the detector selected is set to AVERage, unless the Radio Standard defaults state otherwise e.g. it is set to Peak for Radio Standard = PDC when Device = both MS and BTS, and when Radio Standard = NADC and Device = MS.
- Normal—the detector determines the peak of the CW-like signals, and it yields alternating maximums and minimums of noise-like signals. This is also referred to as Rosenfell detection.
- Average—the detector determines the average of the signal within the sweep points. The averaging method is Power (RMS).
- Peak—the detector determines the maximum of the signal within the sweep points.
- Sample—the detector indicates the instantaneous level of the signal at the center of the sweep points represented by each display point.
- Negative Peak—the detector determines the minimum of the signal within the sweep points.

In swept analysis, the time interval of the data collection for the display sweep points also represents a frequency interval. In FFT analysis, the sweep points represents just a frequency interval. The detector

determines the relationship between the spectrum computed by the FFT and the single data point displayed for the sweep points.

Key Path	Trace/Detector
Initial S/W Revision	Prior to A.02.00

Auto

Sets the detector for the currently selected trace to auto.

Key Path	Trace/Detector
Mode	SA, WCDMA, C2K, WIMAX OFDMA, TD-SCDMA, 1xEVDO, DVB-T/H, DTMB (CTTB), ISDB-T, CMMB, LTE, LTE-TDD, Digital Cable TV, MSR, LTEAFDD, LTEATDD
Remote Command	<code>[:SENSe] :ACPower:DETECTOR:AUTO ON OFF 1 0</code> <code>[:SENSe] :ACPower:DETECTOR:AUTO?</code>
Example	ACP:DET:AUTO 1 ACP:DET?
Couplings	When Detector setting is "Auto" (<code>[:SENSe] :ACPower:DETECTOR:AUTO?</code>), Detector is set to what the Radio Standard defaults states (see detector section) for all conditions of Trace Type and for all traces. When set to Manual, all Traces use the same detector type. When Average State = Off then Trace Types AVERage, MaxHold and MinHold will not function, since Averaging is required to be 'on' for them to operate.
Preset	ON
State Saved	Saved in instrument state.
Range	ON OFF
Initial S/W Revision	Prior to A.02.00
Modified at S/W Revision	A.02.00, A.03.00

Detector Selection

Selects a detector to be used by the analyzer for the current measurement. All traces will use the same detector type, similar to Monitor Spectrum measurement

Key Path	Trace/Detector
Mode	SA, WCDMA, C2K, WIMAX OFDMA, TD-SCDMA, 1xEVDO, DVB-T/H, DTMB (CTTB), ISDB-T, CMMB, LTE, LTE-TDD, Digital Cable TV, MSR, LTEAFDD, LTEATDD
Remote Command	<code>[:SENSe] :ACPower:DETECTOR[:FUNCTION] AVERage NEGative NORMal POSitive SAMPlE</code> <code>[:SENSe] :ACPower:DETECTOR[:FUNCTION]?</code>
Example	ACP:DET NORM ACP:DET?
Notes	When you manually select a detector (instead of selecting Auto), that detector is used regardless of

other analyzer settings.

The detector choices are:

- The Normal detector determines the peak of CW-like signals, and it yields alternating maximums and minimums of noise-like signals. This is also referred to as Rosenfell detection.
- The Average detector determines the average of the signal within the data range. The averaging method is Power (RMS).
- The Peak detector determines the maximum of the signal within the data range.
- The Sample detector indicates the instantaneous level of the signal at the center of the data represented by each display point.
- The Negative Peak detector determines the minimum of the signal within the data range.

Because they may not find a spectral component's true peak, neither average nor sample detectors measure amplitudes of CW signals as accurately as peak or normal, but they do measure noise without the biases of peak detection.

When a detector selection is made, the menu returns to the previous menu.

Couplings	<p>When Detector setting is "Auto" (:SENSe]:ACPower:DETECTOR:AUTO?), Detector is set to what the Radio Standard defaults states (see detector section) for all conditions of Trace Type and for all traces. When set to Manual, all Traces use the same detector type. When Average State = Off then Trace Types AVERage, MaxHold and MinHold will not function, since Averaging is required to be 'on' for them to operate.</p> <p>Only one detector type for all 3 traces is allowed.</p> <p>When Meas Method is RBW or FAST, Detector is disabled.</p>
Preset	AVERage
State Saved	Saved in instrument state.
Range	Normal Average Peak Sample Negative Peak
Backwards Compatibility SCPI	[:SENSe] :ACPR :SWEep :DETECTOR [:FUNCTion]
Initial S/W Revision	Prior to A.02.00
Modified at S/W Revision	A.02.00, A.03.00

Trigger

See ["Trigger" on page 248](#)

Free Run

See ["Free Run " on page 255](#)

Video

See ["Video \(IF Envelope\) " on page 1440](#)

Trigger Level

See ["Trigger Level " on page 1440](#)

Trig Slope

See ["Trig Slope " on page 1441](#)

Trig Delay

See ["Trig Delay " on page 258](#)

External 1

See ["External 1 " on page 1454](#)

Trigger Level

See ["Trigger Level " on page 1455](#)

Trig Slope

See ["Trig Slope " on page 1455](#)

Trig Delay

See ["Trig Delay " on page 261](#)

Zero Span Delay Comp

See ["Zero Span Delay Comp On/Off " on page 1443](#)

External 2

See ["External 2 " on page 1456](#)

Trigger Level

See ["Trigger Level " on page 1457](#)

Trig Slope

See ["Trig Slope " on page 1457](#)

Trig Delay

See "[Trig Delay](#) " on page 264

Zero Span Delay Comp

See "[Zero Span Delay Comp On/Off](#)" on page 1446

RF Burst

See "[RF Burst](#) " on page 1458

Absolute Trigger

See "[Absolute Trigger Level](#)" on page 1458

Relative Trigger

See "[Relative Trigger Level](#)" on page 1448

Trig Slope

See "[Trigger Slope](#) " on page 1459

Trig Delay

See "[Trig Delay](#) " on page 268

Periodic Timer

See "[Periodic Timer \(Frame Trigger\)](#) " on page 1449

Period

See "[Period](#) " on page 1451

Offset

See "[Offset](#) " on page 1451

Reset Offset Display

See "[Reset Offset Display](#) " on page 1453

Sync Source

See "[Sync Source](#) " on page 1453

Off

See "[Off](#) " on page 1454

External 1

See "[External 1](#) " on page 1454

Trigger Level

See "Trigger Level " on page 1455

Trig Slope

See "Trig Slope " on page 1455

External 2

See "External 2 " on page 1456

Trigger Level

See "Trigger Level " on page 1457

Trig Slope

See "Trig Slope " on page 1457

RF Burst

See "RF Burst " on page 1458

Absolute Trigger

See "Absolute Trigger Level" on page 1458

Trig Slope

See "Trigger Slope " on page 1459

Trig Delay

See "Trig Delay" on page 280

Auto/Holdoff

See "Auto/Holdoff " on page 1460

Auto Trig

See "Auto Trig " on page 1461

Trig Holdoff

See "Trig Holdoff " on page 1461

Internal

See "Internal" on page 282

User Preset

Accesses a menu that gives you the following three choices:

- User Preset – recalls a state previously saved using the Save User Preset function.
- User Preset All Modes – presets all of the modes in the analyzer
- Save User Preset– saves the current state for the current mode

NOTE

In products that run multiple instances of the X-Series Application, all instances use the same location to save User Preset state. So Save User Preset of one instance will overwrite the Save User Preset of another instance.

Key Path	Front-panel key
Backwards Compatibility Notes	<p>User Preset is actually loading a state, and in legacy analyzers, it was possible to load a state without affecting the trace data, limit lines or correction data. Similarly it was possible to do a User Preset without affecting the trace data, limit lines or correction data.</p> <p>In the X-Series, “state” always includes all of this data; so whenever state is loaded, or User Preset is executed, all of the traces, limit lines and corrections are affected. Although this differs from previous behavior, it is desirable behavior, and should not cause adverse issues for users.</p> <p>On ESA and PSA, User Preset affected the entire instrument’s state. In the X-Series, User Preset only recalls the state for the active mode. There is a User Preset file for each mode. User Preset can never cause a mode switch as it can in legacy analyzers. If you want to recall all modes to their user preset file state, you will need to do a User Preset after mode switching into each mode.</p> <p>User Preset recalls mode state which can now include data like traces; whereas on ESA and PSA, User Preset did not affect data.</p>
Initial S/W Revision	Prior to A.02.00

User Preset

User Preset sets the state of the currently active mode back to the state that was previously saved for this mode using the Save User Preset menu key or the SCPI command, SYST:PRES:USER:SAV. It not only recalls the Mode Preset settings, but it also recalls all of the mode persistent settings, and the Input/Output system setting that existed at the time Save User Preset was executed.

If a Save User Preset has not been done at any time, User Preset recalls the default user preset file for the currently active mode. The default user preset files are created if, at power-on, a mode detects there is no user preset file. There will never be a scenario when there is no user preset file to restore. For each mode, the default user preset state is the same state that would be saved if a Save User Preset is performed in each mode right after doing a Restore Mode Default and after a Restore Input/Output Defaults.

The User Preset function does the following:

- Aborts the currently running measurement.
- Sets the mode State to the values defined by Save User Preset.
- Makes the saved measurement for the currently running mode the active measurement.
- Brings up the saved menu for the power-on mode.

- Clears the input and output buffers.
- Sets the Status Byte to 0.

Key Path	User Preset
Remote Command	:SYSTem:PRESet:USER
Example	:SYST:PRES:USER:SAVE:SYST:PRES:USER
Notes	:SYST:PRES:USER:SAVE is used to save the current state as the user preset state. Clears all pending OPC bits. The Status Byte is set to 0. Pressing the User Preset front-panel key while already in the User Preset menu will cause the User Preset to get executed
Couplings	A user preset will cause the currently running measurement to be aborted and cause the saved measurement to be active. Recalling a User Preset file has the same issues that recalling a Save State file has. Some settings may need to be limited and therefore re-coupled, since the capabilities of the mode may have changes when the User Preset file was last saved.
Initial S/W Revision	Prior to A.02.00

User Preset All Modes

Recalls all of the User Preset files for each mode, switches to the power-on mode, and activates the saved measurement from the power-on mode User Preset file.

NOTE

When the instrument is secured, all of the user preset files are converted back to their default user preset files.

The User Preset function does the following:

- Aborts the currently running measurement.
- Switches the Mode to the power-on mode.
- Restores the User Preset files for each mode.
- Makes the saved measurement for the power-on mode the active measurement.
- Brings up the saved menu for the power-on mode.
- Clears the input and output buffers.
- Sets the Status Byte to 0.

Key Path	User Preset
Remote Command	:SYSTem:PRESet:USER:ALL
Example	:SYST:PRES:USER:SAVE:SYST:PRES:USER:ALL
Notes	Clears all pending OPC bits. The Status Byte is set to 0. :SYST:PRES:USER:SAVE is used to save the current state as the user preset state.
Couplings	A user preset will cause the currently running measurement to be aborted, cause a mode switch to the power-on mode, and cause the saved measurement to be active in the power-on mode.

Recalling a User Preset file has the same issues that recalling a Save State file has. Some settings may need to be limited and therefore re-coupled, since the capabilities of the mode may have changes when the User Preset file was last saved.

Initial S/W Revision Prior to A.02.00

Save User Preset

Saves the currently active mode and its State. You can recall this User Preset file by pressing the User Preset menu key or sending the SYST:PRES:USER remote command. This same state is also saved by the Save State function.

Key Path	User Preset
Remote Command	:SYSTem:PRESet:USER:SAVE
Example	:SYST:PRES:USER:SAVE
Notes	:SYST:PRES:SAVE creates the same file as if the user requested a *SAV or a MMEM:STOR:STAT, except User Preset Save does not allow the user to specify the filename or the location of the file.
Initial S/W Revision	Prior to A.02.00

View/Display

Accesses a menu of functions that enable you to control the instrument display as well as turn the bar graph On and Off.

If current mode is NOT MSR and LTE-Advanced FDD/TDD mode, the front panel views only contain one view: Spectrum View.

The results of the measurement can be displayed as a single spectrum trace view or displayed with a Bar Graph trace on the spectrum trace.

The display consists of the following two windows:

"Spectrum Window" on page 859

"Results Window" on page 859

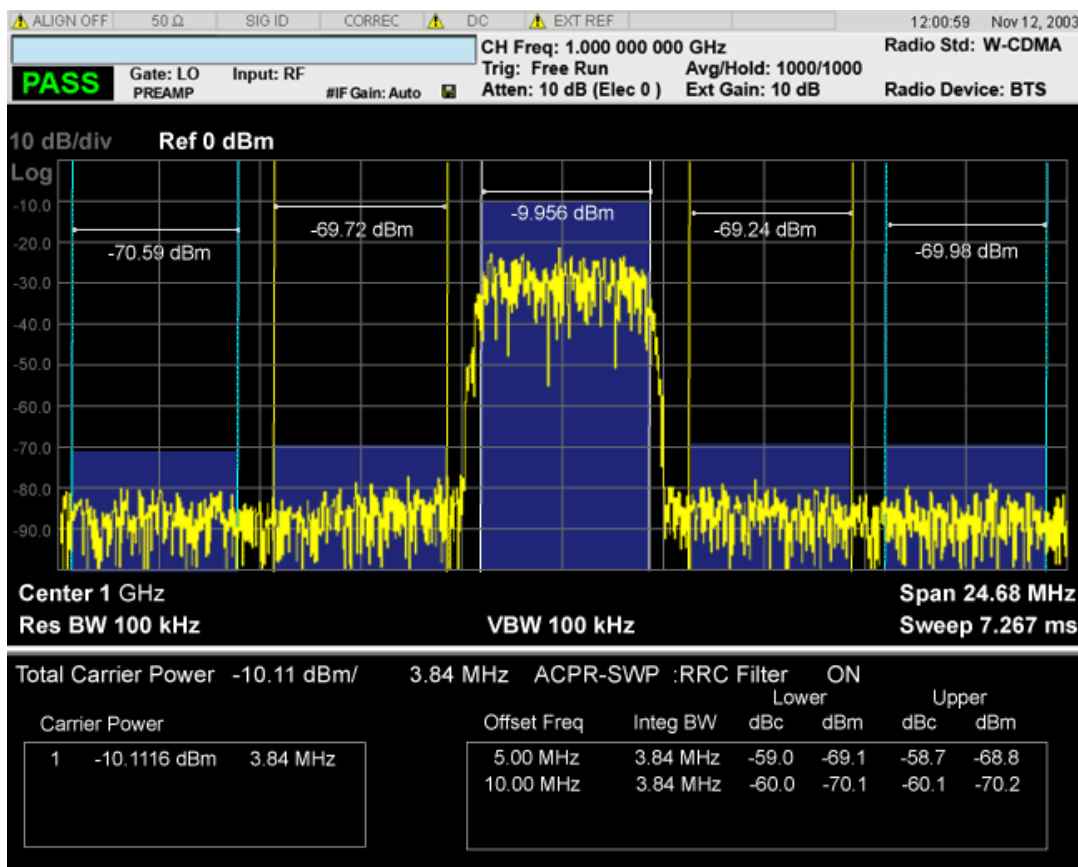

The following two views are only for DTMB (CTTB) and CMMB:

DTMB and CMMB Transmitter:

9 ACP Measurement
View/Display

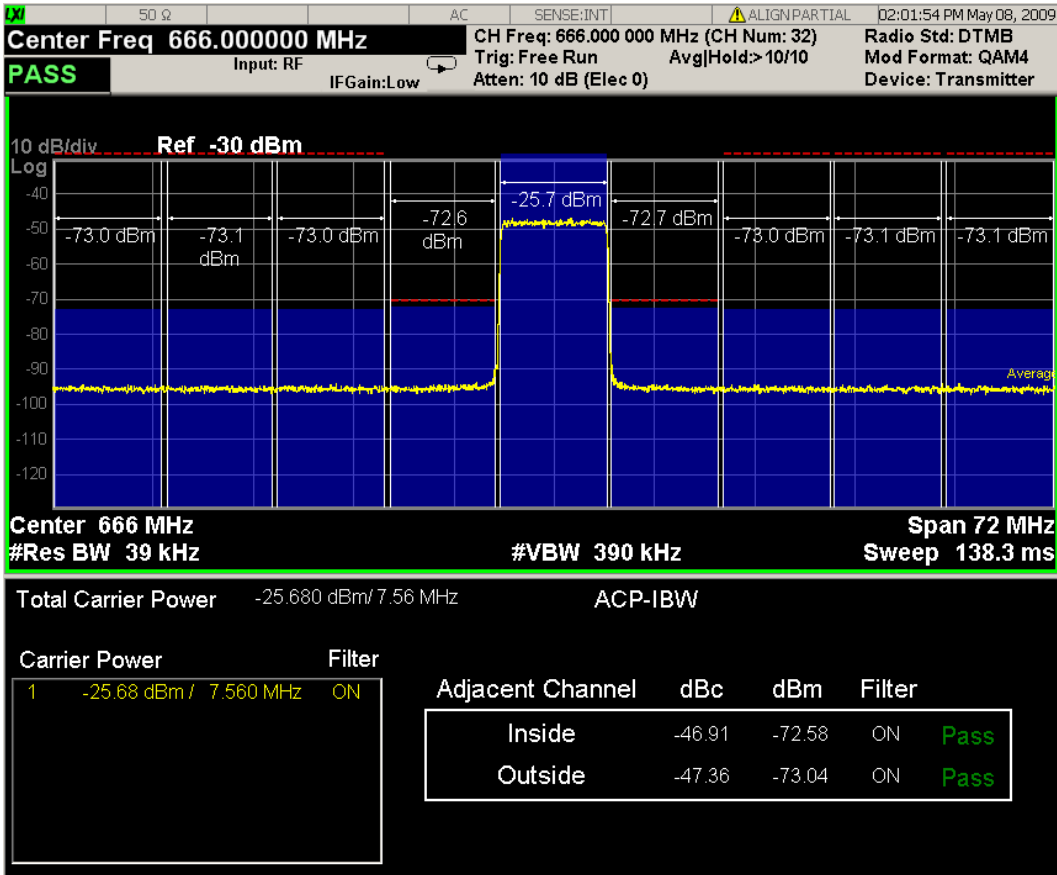

DTMB and CMMB Exciter:

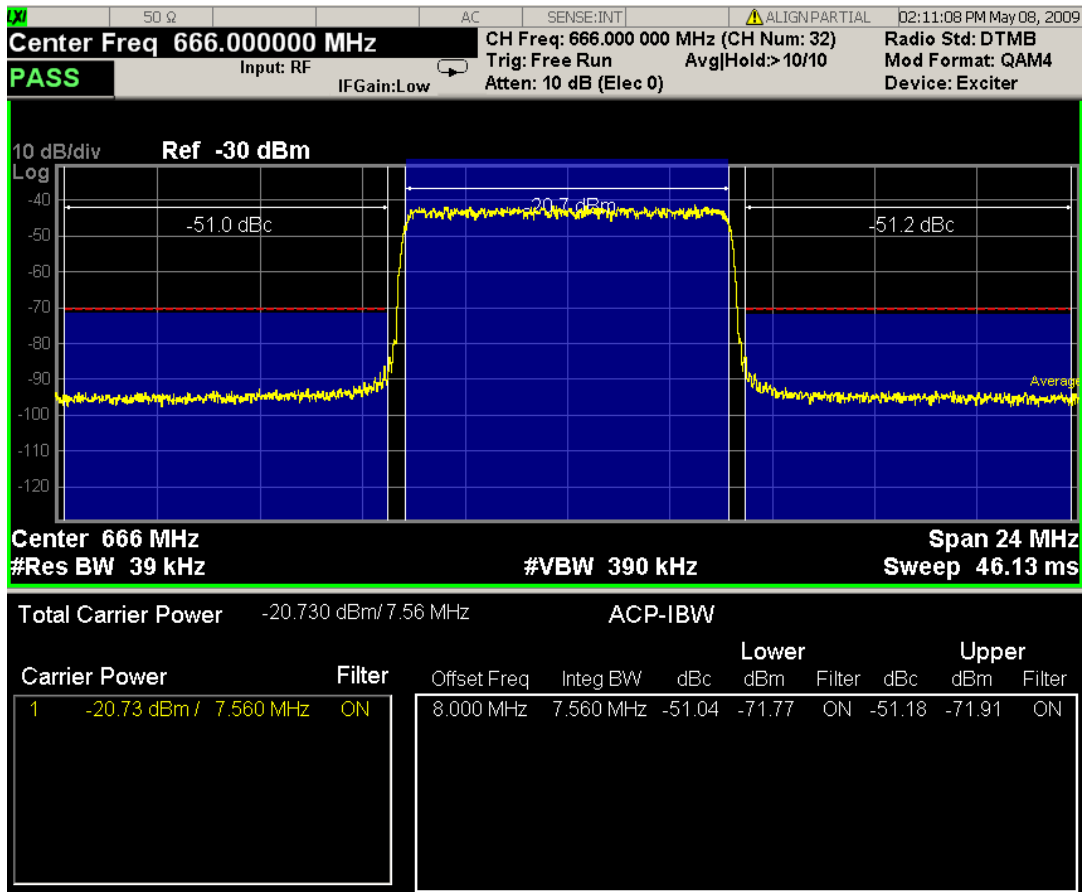

Spectrum Window

When the Bar Graph is On and Limit Test is On, the color of each bar graph reflects the limit test result. When the limit test fails, the bar color is red, and when limit test passes, the bar color is blue.

When RBW is selected as the measurement method, the spectrum trace is not displayed, only the bar graph is displayed. In addition, the Bar Graph key (under the View/Display front-panel key) is set to ON and is grayed out.

The RRC Filter display item is only displayed when RRC filter is on.

Results Window

The text window displays the following results:

Total Carrier Power

This is the total power of all the carriers with carrier power present set to yes. The power is calculated by integrating across the bandwidth declared by the Carrier Integ Bw parameter for each carrier and then totaling the sums. The total integration bandwidth is shown as part of the result. This will be the total of the Carrier Integ Bw of the carriers used in calculating the total carrier power. If the RRC Filter is on, then the integration bandwidth used is $(1 + \alpha)/T$ where $T = 1/(\text{Carrier Integ Bw})$ multiplied by the number of carriers with carrier power present set to yes.

Ref Carrier Power

This is the power in the reference carrier. The power is calculated by integrating across the bandwidth declared by the Carrier Integ Bw parameter for that carrier. The integration bandwidth is shown as part of the result. This is the value of the Carrier Integ Bw for that carrier unless the RRC Filter is on, then the integration bandwidth used is the displayed value, which is $(1 + \alpha)/T$ where $T = 1/(\text{Carrier Integ Bw})$.

Carrier Power

This is the power in all the currently defined carriers. If the carrier has carrier power present, the power will be absolute. If the carrier is defined as not having power present, the power will be relative to the reference carrier. The power is calculated by integrating across the bandwidth declared by the Carrier Integ Bw parameter. The integration bandwidth is shown as part of the result. This is the value of the Carrier Integ Bw for the carrier unless the RRC Filter is on, then the integration bandwidth used is the displayed value, which is $(1 + \alpha)/T$ where $T = 1/(\text{Carrier Integ Bw})$.

As there are potentially more results than can be easily viewed on the display, a scrollable list is used to display all results. The Carrier Results menu key is used to index the carrier amplitude results. This key is grayed out unless the measurement is in single mode (as in continual measurement mode). The display is continuously updating and will not need to be accessed. The currently selected Carrier Result is displayed on the last line of the carrier power result list unless:

- The selected Carrier Result is 4 or less in normal multi carrier power results view. In this case the first 4 carrier power results will be displayed.
- The selected Carrier Result is 9 or greater in normal multi carrier power results view. In this case the last 4 carrier power results will be displayed.
- The zoom mode is selected. In this case all carrier power ranges can be displayed.

Offset Relative Power

This is the power in the offsets relative to the reference carrier. The power is calculated by integrating across the bandwidth declared by the Offset Integ Bw parameter. The offset integration bandwidth is shown as part of the result. This is the value on the Offset Integ Bw menu key unless the RRC Filter is on, then the integration bandwidth used is the displayed value, which is $(1 + \alpha)/T$ where $T = 1/(\text{Offset Integ Bw})$.

Offset Absolute Power

This is the absolute power in the offsets. The power is calculated by integrating across the bandwidth declared by the Offset Integ Bw parameter. The offset integration bandwidth is shown as part of the result. This is the value on the Offset Integ Bw menu key unless the RRC Filter is on, then the integration bandwidth used is the displayed value, which is $(1 + \alpha)/T$ where $T = 1/(\text{Offset Integ Bw})$.

Inside Adjacent Channel Power (DTMB (CTTB) and CMMB only)

This result is only valid for DTMB (CTTB) transmitter and CMMB transmitter. It contains two parts: Relative Power and Absolute Power. The power is calculated by integrating across the bandwidth (Integ Bw) at the frequency Offset A.

Inside Absolute Power = MAX (P_{Lower Offset A}, P_{Upper Offset A});

Inside Relative Power = Inside Absolute Power – Carrier Power;

Outside Adjacent Channel Absolute Power (DTMB (CTTB) and CMMB only)

This result is only valid for DTMB (CTTB) transmitter and CMMB transmitter. It contains two parts: Relative Power and Absolute Power. The power is the Root-Mean-Square of the power calculated by integrating across the bandwidth (Integ Bw) at frequency Offset B, C and D.

$$\text{Outside Absolute Power} = \sqrt{\frac{P_{\text{Lower OffsetB}}^2 + P_{\text{Upper OffsetB}}^2 + P_{\text{Lower OffsetC}}^2 + P_{\text{Upper OffsetC}}^2 + P_{\text{Lower OffsetD}}^2 + P_{\text{Upper OffsetD}}^2}{6}}$$

Outside Relative Power = Outside Absolute Power – Carrier Power;

Key Path	Front-panel key
Initial S/W Revision	Prior to A.02.00

Display

The Display menu is common to most measurements, and is used for configuring items on the display. Some Display menu settings apply to all the measurements in a mode, and some only to the current measurement. Those under the System Display Settings key apply to all measurements in all modes.

Key Path	Display
Key Path	View/Display
Initial S/W Revision	Prior to A.02.00

Annotation

Turns on and off various parts of the display annotation. The annotation is divided up into four categories:

1. Meas Bar: This is the measurement bar at the top of the screen. It does not include the settings panel or the Active Function. Turning off the Meas Bar turns off the settings panel and the Active Function. When the Meas Bar is off, the graticule area expands to fill the area formerly occupied by the Meas Bar.
2. Screen Annotation: this is the annotation and annunciation around the graticule, including any annotation on lines (such as the display line, the threshold line, etc.) This does NOT include the marker number or the N dB result. When off, the graticule expands to fill the entire graticule area.
3. Trace annotation: these are the labels on the traces, showing their detector (or their math mode).
4. Active Function annotation: this is the active function display in the meas bar, and all of the active function values displayed on softkeys.

See the figure below. Each type of annotation can be turned on and off individually.

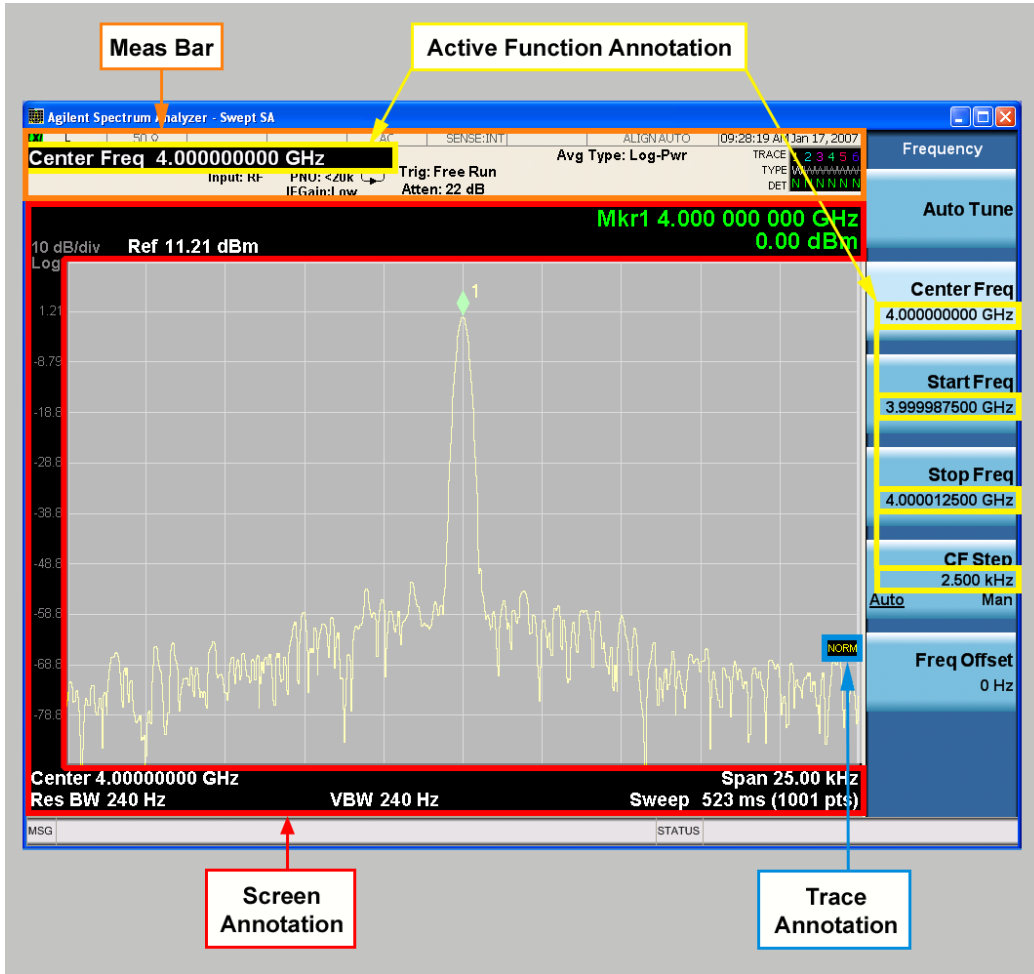

Key Path	View/Display, Display
Initial S/W Revision	Prior to A.02.00

Meas Bar On/Off

This function turns the Measurement Bar on and off, including the settings panel. When off, the graticule area expands to fill the area formerly occupied by the Measurement Bar.

Key Path	View/Display, Display, Annotation
Remote Command	:DISPlay:ANNOtation:MBAR[:STATe] OFF ON 0 1 :DISPlay:ANNOtation:MBAR[:STATe]?
Example	DISP:ANN:MBAR OFF
Dependencies	Grayed out and forced to OFF when System Display Settings, Annotation is set to Off.
Preset	On This should remain Off through a Preset when System DisplaySettings, Annotation is set to Off.

State Saved	Saved in instrument state.
Initial S/W Revision	Prior to A.02.00

Screen

This controls the display of the annunciation and annotation around the graticule, including any annotation on lines (such as the display line, the threshold line, etc.) and the y-axis annotation. This does NOT include marker annotation (or the N dB result). When off, the graticule expands to fill the entire graticule area, leaving only the 1.5% gap above the graticule as described in the Trace/Detector chapter.

Key Path	View/Display, Display, Annotation
Remote Command	:DISPlay:ANNotation:SCReen[:STATe] OFF ON 0 1 :DISPlay:ANNotation:SCReen[:STATe]?
Example	DISP:ANN:SCR OFF
Dependencies	Grayed-out and forced to OFF when System Display Settings, Annotation is set to Off.
Preset	On This should remain Off through a Preset when System DisplaySettings, Annotation is set to Off
State Saved	Saved in instrument state.
Initial S/W Revision	Prior to A.02.00

Active Function Values On/Off

Turns on and off the active function display in the Meas Bar, and all of the active function values displayed on the softkeys.

Note that all of the softkeys that have active functions have these numeric values blanked when this function is on. This is a security feature..

9 ACP Measurement
View/Display

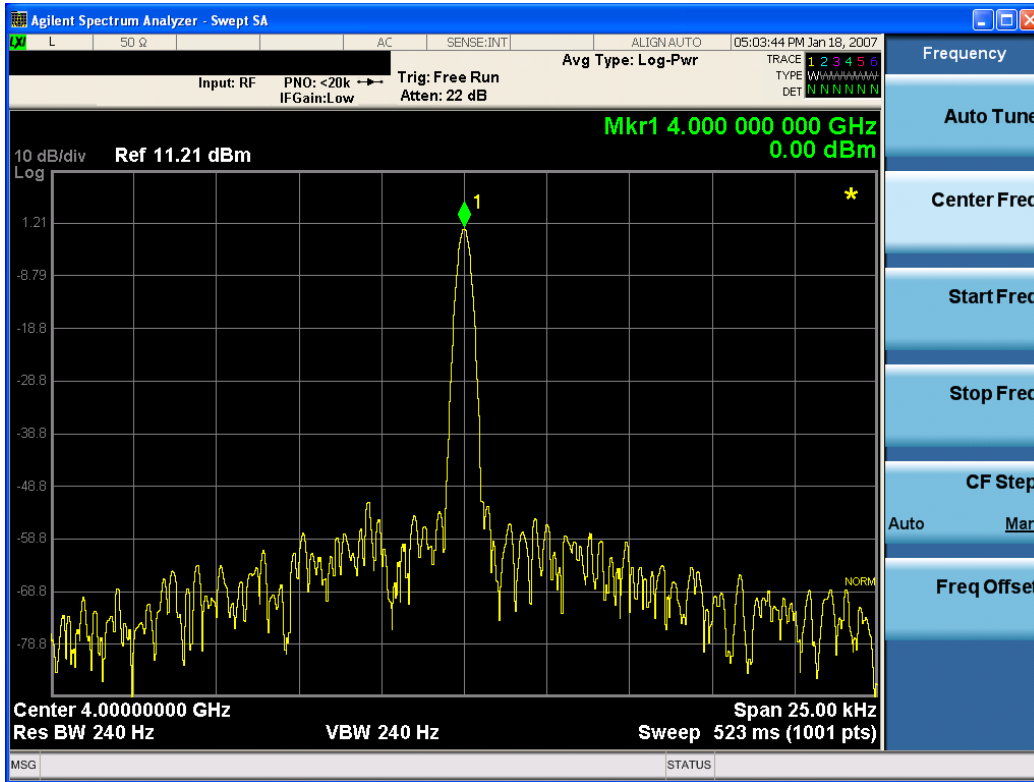

Key Path	View/Display, Display, Annotation
Remote Command	:DISPlay:ACTivefunc[:STATE] ON OFF 1 0 :DISPlay:ACTivefunc[:STATE]?
Example	DISP:ACT OFF
Dependencies	Grayed out and forced to OFF when System Display Settings, Annotation is set to Off.
Preset	On This should remain Off through a Preset when System DisplaySettings, Annotation is set to Off
State Saved	Saved in instrument state.
Initial S/W Revision	Prior to A.02.00

Title

Displays menu keys that enable you to change or clear a title on your display.

Key Path	View/Display, Display
Initial S/W Revision	Prior to A.02.00

Change Title

Writes a title into the "measurement name" field in the banner, for example, "Swept SA".

Press Change Title to enter a new title through the alpha editor. Press Enter or Return to complete the entry. Press ESC to cancel the entry and preserve your existing title.

The display title will replace the measurement name. It remains for this measurement until you press Change Title again, or you recall a state, or a Preset is performed. A title can also be cleared by pressing Title, Clear Title.

NOTE

Notice the inclusion of the <measurement> parameter in the command below. Because each measurement remembers the Display Title, the command must be qualified with the measurement name. For the Swept SA measurement this is not the case; no <measurement> parameter is used when changing the Display Title for the Swept SA measurement.

Key Path	View/Display, Display, Title
Mode	All
Remote Command	:DISPlay:<measurement>:ANNotation:TITLe:DATA <string> :DISPlay:<measurement>:ANNotation:TITLe:DATA?
Example	DISP:ANN:TITL:DATA "This Is My Title" This example is for the Swept SA measurement in the Spectrum Analyzer mode. The SANalyzer <measurement> name is not used. DISP:ACP:ANN:TITL:DATA "This Is My Title" This example is for Measurements other than Swept SA. Both set the title to: This Is My Title
Notes	Pressing this key cancels any active function. When a title is edited the previous title remains intact (it is not cleared) and the cursor goes at the end so that characters can be added or BKSP can be used to go back over previous characters.
Preset	No title (measurement name instead)
State Saved	Saved in instrument state.
Initial S/W Revision	Prior to A.02.00

Clear Title

Clears a title from the front-panel display. Once cleared, the title cannot be retrieved. After the title is cleared, the current Measurement Name replaces it in the title bar.

Key Path	View/Display, Display, Title
Example	The following commands clear the title and restore the measurement's original title: DISP:ANN:TITL:DATA "" This example is for the Swept SA measurement in the Spectrum Analyzer mode. The SANalyzer <measurement> name is not used. DISP:ACP:ANN:TITL:DATA "" This example is for ACP; in measurements other than Swept SA the measurement name is required.
Notes	Uses the :DISPlay:<measurement>:ANNotation:TITLe:DATA <string> command with an empty string (in the Swept SA, the <measurement> is omitted).

Preset	Performed on Preset.
Initial S/W Revision	Prior to A.02.00

Graticule

Pressing Graticule turns the display graticule On or Off. It also turns the graticule y-axis annotation on and off.

Key Path	View/Display, Display
Remote Command	:DISPlay:WINDow[1]:TRACe:GRATicule:GRID[:STATe] OFF ON 0 1 :DISPlay:WINDow[1]:TRACe:GRATicule:GRID[:STATe]?
Example	DISP:WIND:TRAC:GRAT:GRID OFF
Notes	The graticule is the set of horizontal and vertical lines that make up the grid/divisions for the x-axis and y-axis.
Preset	On
State Saved	Saved in instrument state
Initial S/W Revision	Prior to A.02.00

System Display Settings

These settings are "Mode Global" – they affect all modes and measurements and are reset only by Restore Misc Defaults or Restore System Defaults under System.

Key Path	View/Display, Display
Initial S/W Revision	Prior to A.02.00

Annotation Local Settings

This is a Mode Global override of the meas local annotation settings. When it is All Off, it forces ScreenAnnotation, Meas Bar, Trace, and Active Function Values settings to be OFF for all measurements in all modes. This provides the security based "annotation off" function of previous analyzers; hence it uses the legacy SCPI command.

When it is All Off, the Screen, Meas Bar, Trace, and Active Function Values keys under the Display, Annotation menu are grayed out and forced to Off. When Local Settings is selected, you are able to set the local annotation settings on a measurement by measurement basis.

Key Path	View/Display, Display, System Display Settings
Remote Command	:DISPlay:WINDow[1]:ANNotation[:ALL] OFF ON 0 1 :DISPlay:WINDow[1]:ANNotation[:ALL]?
Example	:DISP:WIND:ANN OFF

Preset	On (Set by Restore Misc Defaults)
State Saved	Not saved in instrument state.
Backwards Compatibility Notes	The WINDow parameter and optional subopcode is included for backwards compatibility but ignored – all windows are equally affected.
Initial S/W Revision	Prior to A.02.00

Themes

Accesses a menu of functions that enable you to choose the theme to be used when saving the screen image.

The **Themes** option is the same as the **Themes** option under the **Display** and **Page Setup** dialogs. It allows you to choose between themes to be used when saving the screen image.

Key Path	Save, Screen Image
Remote Command	:MMEMory:STORe:SCReen:THEMe TDColor TDMonochrome FCOLOR FMONochrome :MMEMory:STORe:SCReen:THEMe?
Example	:MMEM:STOR:SCR:THEM TDM
Preset	3D Color; Is not part of Preset, but is reset by Restore Misc Defaults or Restore System Defaults All and survives subsequent running of the modes.
Readback	3D Color 3D Mono Flat Color Flat Mono
Backwards Compatibility Notes	In ESA and PSA we offer the choice of "Reverse Bitmap" or "Reverse Metafile" when saving screen images. This is much like the "Flat Color" theme available in X-Series. Also, if you selected Reverse Bitmap AND a black & white screen image, that would be much like "Flat Monochrome". In other words, each of the X-Series themes has a similar screen image type in ESA/PSA. But they are not identical.
Initial S/W Revision	Prior to A.02.00

3D Color

Selects a standard color theme with each object filled, shaded and colored as designed.

Key Path	Save, Screen Image, Themes
Example	MMEM:STOR:SCR:THEM TDC
Readback	3D Color
Initial S/W Revision	Prior to A.02.00

3D Monochrome

Selects a format that is like 3D color but shades of gray are used instead of colors.

Key Path	Save, Screen Image, Themes
Example	MMEM:STOR:SCR:THEM TDM
Readback	3D Mono
Initial S/W Revision	Prior to A.02.00

Flat Color

Selects a format that is best when the screen is to be printed on an ink printer.

Key Path	Save, Screen Image, Themes
Example	MMEM:STOR:SCR:THEM FCOL
Readback	Flat Color
Initial S/W Revision	Prior to A.02.00

Flat Monochrome

Selects a format that is like Flat Color. But only black is used (no colors, not even gray), and no fill.

Key Path	Save, Screen Image, Themes
Example	MMEM:STOR:SCR:THEM FMON
Readback	Flat Mono
Initial S/W Revision	Prior to A.02.00

Bar Graph

Turns the Bar Graph On and Off.

Key Path	View/Display
Mode	SA, WCDMA, C2K, WIMAX OFDMA, TD-SCDMA, 1xEVDO, DVB-T/H, DTMB (CTTB), ISDB-T, CMMB, LTE, LTETDD, Digital Cable TV, MSR, LTEAFDD, LTEATDD
Remote Command	:DISPlay:ACPower:VIEW[1]:WINDow[1]:BGRaph OFF ON 0 1 :DISPlay:ACPower:VIEW[1]:WINDow[1]:BGRaph?
Example	DISP:ACP:VIEW:WIND:BGR OFF DISP:ACP:VIEW:WIND:BGR?
Notes	You must be in the mode that includes ACP measurements to use this command. Use :INSTrument:SElect to set the mode.
Dependencies	When the method is RBW, this key is always set to On and grayed out.
Preset	ON
State Saved	Saved in instrument state.

Range	On Off
Initial S/W Revision	Prior to A.02.00
Modified at S/W Revision	A.02.00, A.03.00

10 Spectrum Emission Mask Measurement

The spectrum emission mask measures spurious signal levels in up to six pairs of offset frequencies and relates them to the carrier power. For measurement results and views, see ["View/Display" on page 1180](#).

This topic contains the following sections:

["Measurement Commands for Spectrum Emission Mask" on page 872](#)

["Remote Command Results for Spectrum Emission Mask Measurement" on page 873](#)

["Number of Offsets" on page 893](#)

Measurement Commands for Spectrum Emission Mask

Offsets that are turned off (inactive) return -999.0 when their results are queried via SCPI.

```
:CONFigure:SEMask  
:CONFigure:SEMask:NDEFault  
:INITiate:SEMask  
:FETCh:SEMask[n]?  
:MEASure:SEMask[n]?  
:READ:SEMask[n]?
```

For more measurement related commands, see the SENSE subsystem, and the section Remote Measurement Functions@29978.

Remote Command Results for Spectrum Emission Mask Measurement

The following table describes the results returned by the FETCh, MEASure, and READ queries listed above, according to the index value n:

Modes	n	Return Value
All except MSR, WLAN, LTEAFDD, LTEATDD	1	<p>Meas Type: Total Power Reference</p> <p>Returns 82 comma-separated scalar results, in the following order:</p> <ol style="list-style-type: none"> 1. Reserved for the future use, returns -999.0 2. Absolute power at the center frequency (reference) area (dBm) 3. Reserved for the future use, returns -999.0 4. Reserved for the future use, returns -999.0 5. Peak frequency in the center frequency (reference) area (Hz) 6. Reserved for the future use, returns -999.0 7. Reserved for the future use, returns -999.0 8. Reserved for the future use, returns -999.0 9. Reserved for the future use, returns -999.0 10. Reserved for the future use, returns -999.0 11. Relative integrated power on the negative offset A (dBc) 12. Absolute integrated power on the negative offset A (dBm) 13. Relative peak power on the negative offset A (dBc) 14. Absolute peak power on the negative offset A (dBm) 15. Peak power offset frequency from the center or carrier edge frequency in the negative offset A, depending on Offset Frequency Define settings (Hz) 16. Relative integrated power on the positive offset A (dBc) 17. Absolute integrated power on the positive offset A (dBm) 18. Relative peak power on the positive offset A (dBc) 19. Absolute peak power on the positive offset A (dBm) 20. Peak power offset frequency from the center or carrier edge frequency in the positive offset A, depending on Offset Frequency Define settings (Hz) 21. Relative integrated power on the negative offset B (dBc) --- 69. Absolute peak power on the positive offset F (dBm) 70. Peak power offset frequency from the center or carrier edge frequency in the positive offset F, depending on Offset Frequency Define settings (Hz) 71. Minimum margin from limit line on the negative offset A (dB) 72. Minimum margin from limit line on the positive offset A (dB) 73. Minimum margin from limit line on the negative offset B (dB) 74. Minimum margin from limit line on the positive offset B (dB) 75. Minimum margin from limit line on the negative offset C (dB) 76. Minimum margin from limit line on the positive offset C (dB)

Modes	n	Return Value
		77. Minimum margin from limit line on the negative offset D (dB) 78. Minimum margin from limit line on the positive offset D (dB) 79. Minimum margin from limit line on the negative offset E (dB) 80. Minimum margin from limit line on the positive offset E (dB) 81. Minimum margin from limit line on the negative offset F (dB) 82. Minimum margin from limit line on the positive offset F (dB)
All except MSR, WLAN, LTEAFDD, LTEATDD	1	Meas Type: Power Spectral Density Reference Returns 82 comma-separated scalar results, in the following order: <ol style="list-style-type: none"> 1. Reserved for the future use, returns -999.0 2. Absolute power at the center frequency (reference) area (dBm/Hz) 3. Reserved for the future use, returns -999.0 4. Reserved for the future use, returns -999.0 5. Peak frequency in the center frequency (reference) area (Hz) 6. Reserved for the future use, returns -999.0 7. Reserved for the future use, returns -999.0 8. Reserved for the future use, returns -999.0 9. Reserved for the future use, returns -999.0 10. Reserved for the future use, returns -999.0 11. Relative integrated power on the negative offset A (dB) 12. Absolute integrated power on the negative offset A (dBm/Hz) 13. Relative peak power on the negative offset A (dB) 14. Absolute peak power on the negative offset A (dBm/Hz) 15. Peak power offset frequency from the center or carrier edge frequency in the negative offset A, depending on Offset Frequency Define settings (Hz) 16. Relative integrated power on the positive offset A (dB) 17. Absolute integrated power on the positive offset A (dBm/Hz) 18. Relative peak power on the positive offset A (dB) 19. Absolute peak power on the positive offset A (dBm/Hz) 20. Peak power offset frequency from the center or carrier edge frequency in the positive offset A, depending on Offset Frequency Define settings (Hz) 21. Relative integrated power on the negative offset B (dB) --- 69. Absolute peak power on the positive offset F (dBm/Hz) 70. Peak power offset frequency from the center or carrier edge frequency in the positive offset F, depending on Offset Frequency Define settings (Hz) 71. Minimum margin from limit line on the negative offset A (dB) 72. Minimum margin from limit line on the positive offset A (dB) 73. Minimum margin from limit line on the negative offset B (dB) 74. Minimum margin from limit line on the positive offset B (dB)

Modes	n	Return Value
		75. Minimum margin from limit line on the negative offset C (dB) 76. Minimum margin from limit line on the positive offset C (dB) 77. Minimum margin from limit line on the negative offset D (dB) 78. Minimum margin from limit line on the positive offset D (dB) 79. Minimum margin from limit line on the negative offset E (dB) 80. Minimum margin from limit line on the positive offset E (dB) 81. Minimum margin from limit line on the negative offset F (dB) 82. Minimum margin from limit line on the positive offset F (dB)
All except MSR, WLAN, LTEAFDD, LTEATDD	1	Meas Type: Spectrum Peak Reference Returns 82 comma-separated scalar results, in the following order: 1. Reserved for the future use, returns -999.0 2. Peak power at the center frequency (reference) area (dBm) 3. Reserved for the future use, returns -999.0 4. Reserved for the future use, returns -999.0 5. Peak frequency in the center frequency (reference) area (Hz) 6. Reserved for the future use, returns -999.0 7. Reserved for the future use, returns -999.0 8. Reserved for the future use, returns -999.0 9. Reserved for the future use, returns -999.0 10. Reserved for the future use, returns -999.0 11. Reserved for the future use, returns -999.0 12. Reserved for the future use, returns -999.0 13. Relative peak power on the negative offset A (dB) 14. Absolute peak power on the negative offset A (dBm) 15. Peak power offset frequency from the center or carrier edge frequency in the negative offset A, depending on Offset Frequency Define settings (Hz) 16. Reserved for the future use, returns -999.0 17. Reserved for the future use, returns -999.0 18. Relative peak power on the positive offset A (dB) 19. Absolute peak power on the positive offset A (dBm) 20. Peak power offset frequency from the center or carrier edge frequency in the positive offset A, depending on Offset Frequency Define settings (Hz) 21. Reserved for the future use, returns -999.0 --- 69. Absolute peak power on the positive offset F (dBm) 70. Peak power offset frequency from the center or carrier edge frequency in the positive offset F, depending on Offset Frequency Define settings (Hz) 71. Minimum margin from limit line on the negative offset A (dB) 72. Minimum margin from limit line on the positive offset A (dB)

Modes	n	Return Value
		73. Minimum margin from limit line on the negative offset B (dB)
		74. Minimum margin from limit line on the positive offset B (dB)
		75. Minimum margin from limit line on the negative offset C (dB)
		76. Minimum margin from limit line on the positive offset C (dB)
		77. Minimum margin from limit line on the negative offset D (dB)
		78. Minimum margin from limit line on the positive offset D (dB)
		79. Minimum margin from limit line on the negative offset E (dB)
		80. Minimum margin from limit line on the positive offset E (dB)
		81. Minimum margin from limit line on the negative offset F (dB)
		82. Minimum margin from limit line on the positive offset F (dB)
MSR, LTEAFDD, LTEATDD	1	<p>Meas Type: Total Power Reference</p> <p>Returns outer offset results when Non-Contiguous Meas Region is set to Outer, and returns inner offset results when it is set to Inner, in the following order.</p> <ol style="list-style-type: none"> 1. Total Absolute power of carriers of Measure Carrier On if available. Otherwise -999.0 is returned. 2. Absolute reference power. Absolute power at the left reference carrier if Power Ref type is "Left & Right Carriers." Absolute power at the reference carrier of the left sub-block if Power Ref type is "Max Power Carrier in Sub-block." (dBm) 3. Absolute power at the right reference carrier if Power Ref type is "Left & Right Carriers." Absolute power at the reference carrier of the right sub-block if Power Ref type is "Max Power Carrier in Sub-block." Otherwise -999.0 is returned. (dBm) 4. Reserved for the future use, returns -999.0 5. Peak frequency in the ref carrier channel spacing frequency range. Peak frequency in the left ref carrier frequency range if Power Ref Type is "Left & Right Carriers." Peak frequency in the ref carrier frequency range of the left sub-block if Power Ref type is "Max Power Carrier in Sub-block." 6. Peak frequency in the right ref carrier channel spacing frequency range if Power Ref type is "Left & Right Carriers." Peak frequency in the ref carrier frequency range of the right sub-block if Power Ref type is "Max Power Carrier in Sub-block." Otherwise -999.0 is returned. 7. Reserved for the future use, returns -999.0 8. Reserved for the future use, returns -999.0 9. Reserved for the future use, returns -999.0 10. Reserved for the future use, returns -999.0 11. Relative integrated power on the negative offset A (dBc) 12. Absolute integrated power on the negative offset A (dBm) 13. Relative peak power on the negative offset A (dBc) 14. Absolute peak power on the negative offset A (dBm) 15. Peak power offset frequency from the center or carrier edge frequency in the negative offset A, depending on Offset Frequency Define settings (Hz) 16. Relative integrated power on the positive offset A (dBc) 17. Absolute integrated power on the positive offset A (dBm)

Modes	n	Return Value
		18. Relative peak power on the positive offset A (dBc)
		19. Absolute peak power on the positive offset A (dBm)
		20. Peak power offset frequency from the center or carrier edge frequency in the positive offset A, depending on Offset Frequency Define settings (Hz)
		21. Relative integrated power on the negative offset B (dBc)

		69. Absolute peak power on the positive offset F (dBm)
		70. Peak power offset frequency from the center or carrier edge frequency in the positive offset F, depending on Offset Frequency Define settings (Hz)
		71. Minimum margin from limit line on the negative offset A (dB)
		72. Minimum margin from limit line on the positive offset A (dB)
		73. Minimum margin from limit line on the negative offset B (dB)
		74. Minimum margin from limit line on the positive offset B (dB)
		75. Minimum margin from limit line on the negative offset C (dB)
		76. Minimum margin from limit line on the positive offset C (dB)
		77. Minimum margin from limit line on the negative offset D (dB)
		78. Minimum margin from limit line on the positive offset D (dB)
		79. Minimum margin from limit line on the negative offset E (dB)
		80. Minimum margin from limit line on the positive offset E (dB)
		81. Minimum margin from limit line on the negative offset F (dB)
		82. Minimum margin from limit line on the positive offset F (dB)
MSR , LTEAFDD, LTEATDD	1	<p>Meas Type: Power Spectral Density Reference Returns outer offset results when Non-Contiguous Meas Region is set to Outer, and returns inner offset results when it is set to Inner, in the following order.</p> <ol style="list-style-type: none"> 1. Total Absolute power of carriers of Measure Carrier On if available. Otherwise -999.0 is returned. (dBm) 2. Absolute reference power. Absolute power at the left reference carrier if Power Ref type is "Left & Right Carriers." Absolute power at the reference carrier of the left sub-block if Power Ref type is "Max Power Carrier in Sub-block." (dBm/Hz) 3. Absolute power at the right reference carrier if Power Ref type is "Left & Right Carriers." Absolute power at the reference carrier of the right sub-block if Power Ref type is "Max Power Carrier in Sub-block." Otherwise -999.0 is returned. (dBm/Hz) 4. Reserved for the future use, returns -999.0 5. Peak frequency in the ref carrier channel spacing frequency range . Peak frequency in the left ref carrier frequency range if Power Ref type is "Left & Right Carriers." Peak frequency in the ref carrier frequency range of the left sub-block if Power Ref type is "Max Power Carrier in Sub-block." 6. Peak frequency in the right ref carrier channel spacing frequency range if Power Ref type is "Left & Right Carriers." Peak frequency in the ref carrier frequency range of the right sub-block if Power Ref type is "Max Power Carrier in Sub-block." Otherwise -999.0 is returned. 7. Reserved for the future use, returns -999.0

Modes	n	Return Value
		8. Reserved for the future use, returns -999.0
		9. Reserved for the future use, returns -999.0
		10. Reserved for the future use, returns -999.0
		11. Relative integrated power on the negative offset A (dBc)
		12. Absolute integrated power on the negative offset A (dBm/Hz)
		13. Relative peak power on the negative offset A (dBc)
		14. Absolute peak power on the negative offset A (dBm/Hz)
		15. Peak power offset frequency from the center or carrier edge frequency in the negative offset A, depending on Offset Frequency Define settings (Hz)
		16. Relative integrated power on the positive offset A (dBc)
		17. Absolute integrated power on the positive offset A (dBm/Hz)
		18. Relative peak power on the positive offset A (dBc)
		19. Absolute peak power on the positive offset A (dBm/Hz)
		20. Peak power offset frequency from the center or carrier edge frequency in the positive offset A, depending on Offset Frequency Define settings (Hz)
		21. Relative integrated power on the negative offset B (dBc)

		69. Absolute peak power on the positive offset F (dBm/Hz)
		70. Peak power offset frequency from the center or carrier edge frequency in the positive offset F, depending on Offset Frequency Define settings (Hz)
		71. Minimum margin from limit line on the negative offset A (dB)
		72. Minimum margin from limit line on the positive offset A (dB)
		73. Minimum margin from limit line on the negative offset B (dB)
		74. Minimum margin from limit line on the positive offset B (dB)
		75. Minimum margin from limit line on the negative offset C (dB)
		76. Minimum margin from limit line on the positive offset C (dB)
		77. Minimum margin from limit line on the negative offset D (dB)
		78. Minimum margin from limit line on the positive offset D (dB)
		79. Minimum margin from limit line on the negative offset E (dB)
		80. Minimum margin from limit line on the positive offset E (dB)
		81. Minimum margin from limit line on the negative offset F (dB)
		82. Minimum margin from limit line on the positive offset F (dB)
MSR, LTEAFDD, LTEATDD	1	<p>Meas Type: Spectrum Peak Reference</p> <p>Returns outer offset results when Non-Contiguous Meas Region is set to Outer, and returns inner offset results when it is set to Inner, in the following order.</p> <ol style="list-style-type: none"> 1. Total Absolute power of carriers of Measure Carrier On if available. Otherwise -999.0 is returned. (dBm) 2. Peak reference power. Peak power at the left reference carrier if Power Ref type is "Left & Right Carriers." Peak power at the reference carrier of the left sub-block if Power Ref type is "Max Power Carrier in Sub-block." (dBm)

Modes	n	Return Value
		3. Peak power at the right reference carrier if Power Ref type is "Left & Right Carriers." Peak power at the reference carrier of the right sub-block if Power Ref type is "Max Power Carrier in Sub-block." Otherwise -999.0 is returned. (dBm)
		4. Reserved for the future use, returns -999.0
		5. Peak frequency in the ref carrier channel spacing frequency range. Peak frequency in the left ref carrier frequency range if Power Ref type is "Left & Right Carriers." Peak frequency in the ref carrier frequency range of the left sub-block if Power Ref type is "Max Power Carrier in Sub-block."
		6. Peak frequency in the right ref carrier channel spacing frequency range if Power Ref type is "Left & Right Carriers." Peak frequency in the ref carrier frequency range of the right sub-block if Power Ref type is "Max Power Carrier in Sub-block." Otherwise -999.0 is returned.
		7. Reserved for the future use, returns -999.0
		8. Reserved for the future use, returns -999.0
		9. Reserved for the future use, returns -999.0
		10. Reserved for the future use, returns -999.0
		11. Relative integrated power on the negative offset A (dBc)
		12. Absolute integrated power on the negative offset A (dBm)
		13. Relative peak power on the negative offset A (dBc)
		14. Absolute peak power on the negative offset A (dBm)
		15. Peak power offset frequency from the center or carrier edge frequency in the negative offset A, depending on Offset Frequency Define settings (Hz)
		16. Relative integrated power on the positive offset A (dBc)
		17. Absolute integrated power on the positive offset A (dBm)
		18. Relative peak power on the positive offset A (dBc)
		19. Absolute peak power on the positive offset A (dBm)
		20. Peak power offset frequency from the center or carrier edge frequency in the positive offset A, depending on Offset Frequency Define settings (Hz)
		21. Relative integrated power on the negative offset B (dBc)

		69. Absolute peak power on the positive offset F (dBm)
		70. Peak power offset frequency from the center or carrier edge frequency in the positive offset F, depending on Offset Frequency Define settings (Hz)
		71. Minimum margin from limit line on the negative offset A (dB)
		72. Minimum margin from limit line on the positive offset A (dB)
		73. Minimum margin from limit line on the negative offset B (dB)
		74. Minimum margin from limit line on the positive offset B (dB)
		75. Minimum margin from limit line on the negative offset C (dB)
		76. Minimum margin from limit line on the positive offset C (dB)
		77. Minimum margin from limit line on the negative offset D (dB)
		78. Minimum margin from limit line on the positive offset D (dB)
		79. Minimum margin from limit line on the negative offset E (dB)
		80. Minimum margin from limit line on the positive offset E (dB)

Modes	n	Return Value
		81. Minimum margin from limit line on the negative offset F (dB) 82. Minimum margin from limit line on the positive offset F (dB)
WLAN, with radio standard 802.11 ac (80 MHz + 80 MHz)	1	Meas Type: Total Power Reference Returns 82 comma-separated scalar results, in the following order: 1. Reserved for the future use, returns -999.0 2. Absolute reference power (dBm) 3. Absolute power of the carrier of which the frequency is indicated by Freq Segment 1 (dBm) 4. Absolute power of the carrier of which the frequency is indicated by Freq Segment 2 (dBm) 5. Peak frequency in the center frequency (reference) area (Hz) 6. Reserved for the future use, returns -999.0 7. Reserved for the future use, returns -999.0 8. Reserved for the future use, returns -999.0 9. Reserved for the future use, returns -999.0 10. Reserved for the future use, returns -999.0 11. Relative integrated power on the negative offset A (dBc) 12. Absolute integrated power on the negative offset A (dBm) 13. Relative peak power on the negative offset A (dBc) 14. Absolute peak power on the negative offset A (dBm) 15. Peak power offset frequency from the center or carrier edge frequency in the negative offset A, depending on Offset Frequency Define settings (Hz) 16. Relative integrated power on the positive offset A (dBc) 17. Absolute integrated power on the positive offset A (dBm) 18. Relative peak power on the positive offset A (dBc) 19. Absolute peak power on the positive offset A (dBm) 20. Peak power offset frequency from the center or carrier edge frequency in the positive offset A, depending on Offset Frequency Define settings (Hz) 21. Relative integrated power on the negative offset B (dBc) --- 69. Absolute peak power on the positive offset F (dBm) 70. Peak power offset frequency from the center or carrier edge frequency in the positive offset F, depending on Offset Frequency Define settings (Hz) 71. Minimum margin from limit line on the negative offset A (dB) 72. Minimum margin from limit line on the positive offset A (dB) 73. Minimum margin from limit line on the negative offset B (dB) 74. Minimum margin from limit line on the positive offset B (dB) 75. Minimum margin from limit line on the negative offset C (dB) 76. Minimum margin from limit line on the positive offset C (dB) 77. Minimum margin from limit line on the negative offset D (dB) 78. Minimum margin from limit line on the positive offset D (dB)

Modes	n	Return Value
		79. Minimum margin from limit line on the negative offset E (dB)
		80. Minimum margin from limit line on the positive offset E (dB)
		81. Minimum margin from limit line on the negative offset F (dB)
		82. Minimum margin from limit line on the positive offset F (dB)
WLAN, with radio standard 802.11 ac (80 MHz + 80 MHz)	1	<p>Meas Type: Power Spectral Density Reference Returns 82 comma-separated scalar results, in the following order:</p> <ol style="list-style-type: none"> 1. Reserved for the future use, returns -999.0 2. Absolute reference power (dBm/Hz) 3. Absolute power of the carrier of which the frequency is indicated by Freq Segment 1 (dBm/Hz) 4. Absolute power of the carrier of which the frequency is indicated by Freq Segment 2 (dBm/Hz) 5. Peak frequency in the center frequency (reference) area (Hz) 6. Reserved for the future use, returns -999.0 7. Reserved for the future use, returns -999.0 8. Reserved for the future use, returns -999.0 9. Reserved for the future use, returns -999.0 10. Reserved for the future use, returns -999.0 11. Relative integrated power on the negative offset A (dB) 12. Absolute integrated power on the negative offset A (dBm/Hz) 13. Relative peak power on the negative offset A (dB) 14. Absolute peak power on the negative offset A (dBm/Hz) 15. Peak power offset frequency from the center or carrier edge frequency in the negative offset A, depending on Offset Frequency Define settings (Hz) 16. Relative integrated power on the positive offset A (dB) 17. Absolute integrated power on the positive offset A (dBm/Hz) 18. Relative peak power on the positive offset A (dB) 19. Absolute peak power on the positive offset A (dBm/Hz) 20. Peak power offset frequency from the center or carrier edge frequency in the positive offset A, depending on Offset Frequency Define settings (Hz) 21. Relative integrated power on the negative offset B (dB) --- 69. Absolute peak power on the positive offset F (dBm/Hz) 70. Peak power offset frequency from the center or carrier edge frequency in the positive offset F, depending on Offset Frequency Define settings (Hz) 71. Minimum margin from limit line on the negative offset A (dB) 72. Minimum margin from limit line on the positive offset A (dB) 73. Minimum margin from limit line on the negative offset B (dB) 74. Minimum margin from limit line on the positive offset B (dB) 75. Minimum margin from limit line on the negative offset C (dB) 76. Minimum margin from limit line on the positive offset C (dB)

Modes	n	Return Value
		77. Minimum margin from limit line on the negative offset D (dB) 78. Minimum margin from limit line on the positive offset D (dB) 79. Minimum margin from limit line on the negative offset E (dB) 80. Minimum margin from limit line on the positive offset E (dB) 81. Minimum margin from limit line on the negative offset F (dB) 82. Minimum margin from limit line on the positive offset F (dB)
All	2	Returns the displayed frequency domain spectrum trace data separated by comma. The number of data points is 2001.
All	3	Returns the displayed frequency domain absolute limit trace data separated by comma. The number of data points is 2001.
All	4	Returns the displayed frequency domain relative limit trace data separated by comma. The number of data points is 2001.
All (see details)	5	<p>Meas Type: Total Power Reference Returns comma-separated scalar values (in dBm) of the absolute integrated power of the segment frequencies. The length of the result depends on the number of available offset (See "Number of Offsets" on page 893).</p> <ol style="list-style-type: none"> Total power reference (dBm) Reserved for the future use, returns -999.0 Absolute integrated power at negative offset frequency (A) Absolute integrated power at positive offset frequency (A) --- Absolute integrated power at negative offset frequency (L) Absolute integrated power at positive offset frequency (L) <p>In MSR and LTE-Advanced FDD/TDD mode. Returns outer offset results when Non-Contiguous Meas Region is set to Outer, and returns inner offset results when it is set to Inner, in the following order.</p> <ol style="list-style-type: none"> Ref carrier power. Left ref carrier power if Power Ref type is "Left & Right Carriers." Ref carrier power of the left sub-block if Power Ref type is "Max Power Carrier in Sub-block." (dBm) Right ref carrier power if Ref channel type is "Left & Right Carriers." Ref carrier power of the right sub-block if Power Ref type is "Max Power Carrier in Sub-block." Otherwise -999.0 is returned. (dBm) Absolute integrated power at negative offset frequency (A) Absolute integrated power at positive offset frequency (A) --- Absolute integrated power at negative offset frequency (L) Absolute integrated power at positive offset frequency (L) <p>In WLAN mode. Returns 26 comma-separated scalar values (in dBm) of the absolute integrated power of the segment frequencies:</p> <ol style="list-style-type: none"> Ref carrier power (dBm) Reserved for the future use, returns -999.0

Modes	n	Return Value
		<p>3. Absolute integrated power at negative offset frequency (A)</p> <p>4. Absolute integrated power at positive offset frequency (A)</p> <p>---</p> <p>25. Absolute integrated power at negative offset frequency (L)</p> <p>26. Absolute integrated power at positive offset frequency (L)</p> <p>If the result is not available, -999.0 is returned.</p> <p>The number of values returned is subject to change in future releases.</p>
All (see details)	5	<p>Meas Type: Power Spectral Density Reference</p> <p>Returns comma-separated scalar values (in dBm/Hz) of the absolute integrated power of the segment frequencies. The length of the result depends on the number of available offset (See "Number of Offsets" on page 893).</p> <p>1. Power spectral density reference (dBm/Hz)</p> <p>2. Reserved for the future use, returns -999.0</p> <p>3. Absolute integrated power at negative offset frequency (A)</p> <p>4. Absolute integrated power at positive offset frequency (A)</p> <p>---</p> <p>25. Absolute integrated power at negative offset frequency (L)</p> <p>26. Absolute integrated power at positive offset frequency (L)</p> <p>In MSR and LTE-Advanced FDD/TDD mode.</p> <p>Returns outer offset results when Non-Contiguous Meas Region is set to Outer, and returns inner offset results when it is set to Inner, in the following order.</p> <p>1. Ref carrier power. Left ref carrier power if Power Ref type is "Left & Right Carriers" Ref carrier power of the left sub-block if Power Ref type is "Max Power Carrier in Sub-block." (dBm/Hz)</p> <p>2. Right ref carrier power if Power Ref type is "Left & Right Carriers." Ref carrier power of the right sub-block if Power Ref type is "Max Power Carrier in Sub-block." Otherwise -999.0 is returned. (dBm/Hz)</p> <p>3. Absolute integrated power at negative offset frequency (A)</p> <p>4. Absolute integrated power at positive offset frequency (A)</p> <p>---</p> <p>25. Absolute integrated power at negative offset frequency (L)</p> <p>26. Absolute integrated power at positive offset frequency (L)</p> <p>In WLAN mode.</p> <p>Returns 26 comma-separated scalar values (in dBm/Hz) of the absolute integrated power of the segment frequencies:</p> <p>1. Ref carrier power (dBm/Hz)</p> <p>2. Reserved for the future use, returns -999.0</p> <p>3. Absolute integrated power at negative offset frequency (A)</p> <p>4. Absolute integrated power at positive offset frequency (A)</p> <p>---</p> <p>25. Absolute integrated power at negative offset frequency (L)</p>

Modes	n	Return Value
		<p>26. Absolute integrated power at positive offset frequency (L)</p> <p>If the result is not available, -999.0 is returned.</p> <p>The number of values returned is subject to change in future releases.</p>
All (see details)	5	<p>Meas Type: Spectrum Peak Reference</p> <p>Returns comma-separated scalar values (in dBm) of the absolute peak power of the segment frequencies. The length of the result depends on the number of available offset (See "Number of Offsets" on page 893).</p> <ol style="list-style-type: none"> 1. Spectrum Peak Power reference (dBm) 2. Reserved for the future use, returns -999.0 3. Absolute peak power at negative offset frequency (A) 4. Absolute peak power at positive offset frequency (A) <p>---</p> <p>25. Absolute peak power at negative offset frequency (L)</p> <p>26. Absolute peak power at positive offset frequency (L)</p> <p>In MSR and LTE-Advanced FDD/TDD mode.</p> <p>Returns outer offset results when Non-Contiguous Meas Region is set to Outer, and returns inner offset results when it is set to Inner, in the following order.</p> <ol style="list-style-type: none"> 1. Spectrum Peak Power reference of ref carrier. Spectrum Peak Power reference of left ref carrier if Power Ref type is "Left & Right Carriers." Spectrum Peak Power reference of the left sub-block if Power Ref type is "Max Power Carrier in Sub-block." (dBm) 2. Spectrum Peak Power reference of right ref carrier power if Power Ref type is "Left & Right carriers." Spectrum Peak Power reference of the right sub-block if Power Ref type is "Max Power Carrier in Sub-block." Otherwise -999.0 is returned. (dBm) 3. Absolute peak power at negative offset frequency (A) 4. Absolute peak power at positive offset frequency (A) <p>---</p> <p>25. Absolute peak power at negative offset frequency (L)</p> <p>26. Absolute peak power at positive offset frequency (L)</p> <p>If the result is not available, -999.0 is returned.</p> <p>The number of values returned is subject to change in future releases.</p>
All	6	<p>Meas Type: Total Power Reference</p> <p>Returns comma-separated scalar values (in dBc) of the integrated power relative to the carrier at the segment frequencies. The length of the result depends on the number of available offset (See "Number of Offsets" on page 893).</p> <p>When in the MSR and LTE-Advanced FDD/TDD mode, returns outer offset results when Non-Contiguous Meas Region is set to Outer, and returns inner offset results when it is set to Inner, in the following order.</p> <ol style="list-style-type: none"> 1. Reserved for the future use, returns -999.0 2. Reserved for the future use, returns -999.0 3. Relative integrated power at negative offset frequency (A)

Modes	n	Return Value
		<p>4. Relative integrated power at positive offset frequency (A)</p> <p>---</p> <p>25. Relative integrated power at negative offset frequency (L)</p> <p>26. Relative integrated power at positive offset frequency (L)</p> <p>If the result is not available, -999.0 is returned.</p> <p>The number of values returned is subject to change in future releases.</p>
All	6	<p>Meas Type: Power Spectral Density Reference</p> <p>Returns comma-separated scalar values (in dBc/Hz) of the integrated power relative to the carrier at the segment frequencies. The length of the result depends on the number of available offset (See "Number of Offsets" on page 893).</p> <p>When in the MSR and LTE-Advanced FDD/TDD mode, returns outer offset results when Non-Contiguous Meas Region is set to Outer, and returns inner offset results when it is set to Inner, in the following order.</p> <p>Returns -999.0 for the offsets if in WLAN:</p> <ol style="list-style-type: none"> 1. Reserved for the future use, returns -999.0 2. Reserved for the future use, returns -999.0 3. Relative integrated power at negative offset frequency (A) 4. Relative integrated power at positive offset frequency (A) <p>---</p> <p>25. Relative integrated power at negative offset frequency (L)</p> <p>26. Relative integrated power at positive offset frequency (L)</p> <p>If the result is not available, -999.0 is returned.</p> <p>The number of values returned is subject to change in future releases.</p>
All	6	<p>Meas Type: Spectrum Peak Reference</p> <p>Returns comma-separated scalar values (in dB) of the integrated power relative to the carrier at the segment frequencies. The length of the result depends on the number of available offset (See "Number of Offsets" on page 893).</p> <p>When in the MSR and LTE-Advanced FDD/TDD mode, returns outer offset results when Non-Contiguous Meas Region is set to Outer, and returns inner offset results when it is set to Inner, in the following order.</p> <ol style="list-style-type: none"> 1. Reserved for the future use, returns -999.0 2. Reserved for the future use, returns -999.0 3. Relative peak power at negative offset frequency (A) 4. Relative peak power at positive offset frequency (A) <p>---</p> <p>25. Relative peak power at negative offset frequency (L)</p> <p>26. Relative peak power at positive offset frequency (L)</p> <p>If the result is not available, -999.0 is returned.</p> <p>The number of values returned is subject to change in future releases.</p>
All	7	

Modes	n	Return Value
		<p>Returns comma-separated pass/fail test results (0=passed, or 1=failed) determined by testing the minimum margin point from the limit line that is determined each offset's Limits setting. The length of the result depends on the number of available offset (See "Number of Offsets" on page 893).</p> <p>When in the MSR and LTE-Advanced FDD/TDD mode, returns outer offset results when Non-Contiguous Meas Region is set to Outer, and returns inner offset results when it is set to Inner, in the following order.</p> <ol style="list-style-type: none"> 1. Reserved for the future use, returns -999.0 2. Reserved for the future use, returns -999.0 3. At negative offset frequency (A) 4. At positive offset frequency (A) --- 25. At negative offset frequency (L) 26. At positive offset frequency (L) <p>The number of values returned is subject to change in future releases.</p>
All	8	<p>Offset Pass/Fail.</p> <p>Returns comma-separated pass/fail test results (0=passed, or 1=failed) determined by testing the minimum margin point from the limit line that is determined each offset's Limits setting. The length of the result depends on the number of available offset (See "Number of Offsets" on page 893).</p> <p>When in the MSR and LTE-Advanced FDD/TDD mode, returns outer offset results when Non-Contiguous Meas Region is set to Outer, and returns inner offset results when it is set to Inner, in the following order.</p> <p>Note: These results (n=8) are the same as n=7 result.</p> <ol style="list-style-type: none"> 1. Reserved for the future use, returns -999.0 2. Reserved for the future use, returns -999.0 3. At negative offset frequency (A) 4. At positive offset frequency (A) --- 25. At negative offset frequency (L) 26. At positive offset frequency (L) <p>The number of values returned is subject to change in future releases.</p>
All	9	<p>Offset Peak Power Freq.</p> <p>Returns comma-separated scalar values of frequency (in Hz) that have peak power from center or carrier edge frequency in each offset, depending on Offset Frequency Define settings. The length of the result depends on the number of available offset (See "Number of Offsets" on page 893).</p> <p>When in the MSR and LTE-Advanced FDD/TDD mode, returns outer offset results when Non-Contiguous Meas Region is set to Outer, and returns inner offset results when it is set to Inner, in the following order.</p> <ol style="list-style-type: none"> 1. Reserved for the future use, returns -999.0 2. Reserved for the future use, returns -999.0 3. Negative offset frequency (A)

Modes	n	Return Value
		<p>4. Positive offset frequency (A)</p> <p>---</p> <p>25. Negative offset frequency (L)</p> <p>26. Positive offset frequency (L)</p> <p>If the result is not available, -999.0 is returned.</p> <p>The number of values returned is subject to change in future releases.</p>
All	10	<p>Offset Abs Peak Power.</p> <p>Returns comma-separated scalar values (in dBm) of the absolute peak power of the segment frequencies. The length of the result depends on the number of available offset (See "Number of Offsets" on page 893).</p> <p>When in the MSR and LTE-Advanced FDD/TDD mode, returns outer offset results when Non-Contiguous Meas Region is set to Outer, and returns inner offset results when it is set to Inner, in the following order.</p> <ol style="list-style-type: none"> 1. Reserved for the future use, returns -999.0 2. Reserved for the future use, returns -999.0 3. At negative offset frequency (A) 4. At positive offset frequency (A) <p>---</p> <ol style="list-style-type: none"> 25. At negative offset frequency (L) 26. At positive offset frequency (L) <p>If the result is not available, -999.0 is returned.</p> <p>The number of values returned is subject to change in future releases.</p>
All	11	<p>Offset Rel Peak Power.</p> <p>Returns comma-separated scalar values in dBc (dB if MeasType = PSD) of the peak power relative to the carrier at the segment frequencies. The length of the result depends on the number of available offset (See "Number of Offsets" on page 893).</p> <p>When in the MSR and LTE-Advanced FDD/TDD mode, returns outer offset results when Non-Contiguous Meas Region is set to Outer, and returns inner offset results when it is set to Inner, in the following order.</p> <ol style="list-style-type: none"> 1. Reserved for the future use, returns -999.0 2. Reserved for the future use, returns -999.0 3. At negative offset frequency (A) 4. At positive offset frequency (A) <p>---</p> <ol style="list-style-type: none"> 25. At negative offset frequency (L) 26. At positive offset frequency (L) <p>If the result is not available, -999.0 is returned.</p> <p>The number of values returned is subject to change in future releases.</p>
All	12	<p>Returns the power result (the peak power of the signal in the ref channel) when Meas Type is Spectrum Peak reference. Otherwise, the value returned will be -999.0.</p> <p>When in the MSR and LTE-Advanced FDD/TDD mode, returns outer offset results when Non-</p>

Modes	n	Return Value
		<p>Contiguous Meas Region is set to Outer, and returns inner offset results when it is set to Inner, in the following order.</p>
MSR, LTEAFDD, LTEATDD only	13	<p>Meas Type: Total Power Reference Returns outer offset results when Non-Contiguous Meas Region is set to Outer, and returns inner offset results when it is set to Inner, in the following order.</p> <ol style="list-style-type: none"> 1. Total Absolute power of carriers of Measure Carrier On if Power Ref Type is "Max Power Carrier," "Max Power Carrier in Sub-block," or "RF Bandwidth." Otherwise NaN (9.91E+37) is returned. (dBm) 2. Absolute reference power. Absolute power at the left reference carrier if Power Ref type is "Left & Right Carriers." Absolute power at the reference carrier of the left sub-block if Power Ref type is "Max Power Carrier in Sub-block." (dBm) 3. Absolute power at the right reference carrier if Power Ref type is "Left & Right Carriers." Absolute power at the reference carrier of the right sub-block if Power Ref type is "Max Power Carrier in Sub-block." Otherwise NaN (9.91E+37) is returned. (dBm) 4. Peak frequency in the measured ref carrier frequency range. Peak frequency in the left ref carrier frequency range if Power Ref type is "Left & Right Carriers." Peak frequency in the ref carrier frequency range of the left sub-block if Power Ref type is "Max Power Carrier in Sub-block." (Hz) 5. Peak frequency in the right ref carrier frequency range if Power Ref type is "Left & Right Carriers." Peak frequency in the ref carrier frequency range of the right sub-block if Power Ref type is "Max Power Carrier in Sub-block." Otherwise NaN (9.91E+37) is returned. (Hz) <p>If the result is not available, NaN (9.91E+37) is returned. The number of values returned is subject to change in future releases.</p>
MSR, LTEAFDD, LTEATDD only	13	<p>Meas Type: Power Spectral Density Reference Returns outer offset results when Non-Contiguous Meas Region is set to Outer, and returns inner offset results when it is set to Inner, in the following order.</p> <ol style="list-style-type: none"> 1. Total Absolute power of carriers of Measure Carrier On if Power Ref Type is "Max Power Carrier," "Max Power Carrier in Sub-block," or "RF Bandwidth." Otherwise NaN (9.91E+37) is returned. (dBm) 2. Absolute reference power. Absolute power at the left reference carrier if Power Ref type is "Left & Right Carriers." Absolute power at the reference carrier of the left sub-block if Power Ref type is "Max Power Carrier in Sub-block." (dBm/Hz) 3. Absolute power at the right reference carrier if Power Ref type is "Left & Right Carriers." Absolute power at the reference carrier of the right sub-block if Power Ref type is "Max Power Carrier in Sub-block." Otherwise NaN (9.91E+37) is returned. (dBm/Hz) 4. Peak frequency in the measured ref carrier frequency range. Peak frequency in the left ref carrier frequency range if Power Ref type is "Left & Right Carriers." Peak frequency in the ref carrier frequency range of the left sub-block if Power Ref type is "Max Power Carrier in Sub-block." (Hz) 5. Peak frequency in the right ref carrier frequency range if Power Ref type is "Left & Right Carriers." Peak frequency in the ref carrier frequency range of the right sub-block if Power Ref

Modes	n	Return Value
		<p>type is "Max Power Carrier in Sub-block." Otherwise NaN (9.91E+37) is returned. (Hz)</p> <p>If the result is not available, NaN (9.91E+37) is returned.</p> <p>The number of values returned is subject to change in future releases.</p>
MSR, LTEAFDD, LTEATDD only	13	<p>Meas Type: Power Spectrum Peak Reference</p> <p>Returns outer offset results when Non-Contiguous Meas Region is set to Outer, and returns inner offset results when it is set to Inner, in the following order.</p> <ol style="list-style-type: none"> 1. Total Absolute power of carriers of Measure Carrier On if Power Ref Type is "Max Power Carrier," "Max Power Carrier in Sub-block," or "RF Bandwidth." Otherwise NaN (9.91E+37) is returned. (dBm) 2. Peak reference power. Peak power at the left reference carrier if Power Ref type is "Left & Right Carriers." Peak power at the reference carrier of the left sub-block if Power Ref type is "Max Power Carrier in Sub-block." (dBm) 3. Peak power at the right reference carrier if Power Ref type is "Left & Right Carriers." Peak power at the reference carrier of the right sub-block if Power Ref type is "Max Power Carrier in Sub-block." Otherwise NaN (9.91E+37) is returned. (dBm) 4. Peak frequency in the measured ref carrier frequency range. Peak frequency in the left ref carrier frequency range if Power Ref type is "Left & Right Carriers." Peak frequency in the ref carrier frequency range of the left sub-block if Power Ref type is "Max Power Carrier in Sub-block." (Hz) 5. Peak frequency in the right ref carrier frequency range if Power Ref type is "Left & Right Carriers." Peak frequency in the ref carrier frequency range of the right sub-block if Power Ref type is "Max Power Carrier in Sub-block." Otherwise NaN (9.91E+37) is returned. (Hz) <p>If the result is not available, NaN (9.91E+37) is returned.</p> <p>The number of values returned is subject to change in future releases.</p>
All	14	<p>Meas Type: Total Power Reference</p> <p>Returns comma-separated scalar results, in the following order:</p> <p>When in the MSR and LTE-Advanced FDD/TDD mode, returns outer offset results when Non-Contiguous Meas Region is set to Outer, and returns inner offset results when it is set to Inner, in the following order.</p> <ol style="list-style-type: none"> 1. Relative integrated power on the negative offset A (dBc) 2. Absolute integrated power on the negative offset A (dBm) 3. Relative peak power on the negative offset A (dBc) 4. Absolute peak power on the negative offset A (dBm) 5. Peak power offset frequency from the center or carrier edge frequency in the negative offset A, depending on Offset Frequency Define settings (Hz) 6. Relative integrated power on the positive offset A (dBc) 7. Absolute integrated power on the positive offset A (dBm) 8. Relative peak power on the positive offset A (dBc) 9. Absolute peak power on the positive offset A (dBm)

Modes	n	Return Value
		<p>10. Peak power offset frequency from the center or carrier edge frequency in the positive offset A, depending on Offset Frequency Define settings (Hz)</p> <p>11. Relative integrated power on the negative offset B (dBc)</p> <p>---</p> <p>119. Absolute peak power on the positive offset L (dBm)</p> <p>120. Peak power offset frequency from the center or carrier edge frequency in the positive offset L, depending on Offset Frequency Define settings (Hz)</p> <p>If the result is not available, NaN (9.91 E+37) is returned.</p> <p>The length of the result depends on the number of available offset (See "Number of Offsets" on page 893).</p> <p>The number of values returned is subject to change in future releases.</p>
All	14	<p>Meas Type: Power Spectral Density Reference</p> <p>Returns comma-separated scalar results, in the following order:</p> <p>When in the MSR and LTE-Advanced FDD/TDD mode, returns outer offset results when Non-Contiguous Meas Region is set to Outer, and returns inner offset results when it is set to Inner, in the following order.</p> <ol style="list-style-type: none"> 1. Relative integrated power on the negative offset A (dB) 2. Absolute integrated power on the negative offset A (dBm/Hz) 3. Relative peak power on the negative offset A (dB) 4. Absolute peak power on the negative offset A (dBm/Hz) 5. Peak power offset frequency from the center or carrier edge frequency in the negative offset A, depending on Offset Frequency Define settings (Hz) 6. Relative integrated power on the positive offset A (dB) 7. Absolute integrated power on the positive offset A (dBm/Hz) 8. Relative peak power on the positive offset A (dB) 9. Absolute peak power on the positive offset A (dBm/Hz) 10. Peak power offset frequency from the center or carrier edge frequency in the positive offset A, depending on Offset Frequency Define settings (Hz) 11. Relative integrated power on the negative offset B (dB) <p>---</p> <p>119. Absolute peak power on the positive offset L (dBm/Hz)</p> <p>120. Peak power offset frequency from the center or carrier edge frequency in the positive offset L, depending on Offset Frequency Define settings (Hz)</p> <p>If the result is not available, NaN (9.91 E+37) is returned.</p> <p>The length of the result depends on the number of available offset (See "Number of Offsets" on page 893).</p> <p>The number of values returned is subject to change in future releases.</p>
All	14	<p>Meas Type: Spectrum Peak Reference</p> <p>Returns comma-separated scalar results, in the following order:</p>

Modes	n	Return Value
		<p>When in the MSR and LTE-Advanced FDD/TDD mode, returns outer offset results when Non-Contiguous Meas Region is set to Outer, and returns inner offset results when it is set to Inner, in the following order.</p> <ol style="list-style-type: none"> 1. Reserved for the future use, returns NaN (9.91E+37) 2. Reserved for the future use, returns NaN (9.91E+37) 3. Relative peak power on the negative offset A (dB) 4. Absolute peak power on the negative offset A (dBm) 5. Peak power offset frequency from the center or carrier edge frequency in the negative offset A, depending on Offset Frequency Define settings (Hz) 6. Reserved for the future use, returns NaN (9.91E+37) 7. Reserved for the future use, returns NaN (9.91E+37) 8. Relative peak power on the positive offset A (dB) 9. Absolute peak power on the positive offset A (dBm) 10. Peak power offset frequency from the center or carrier edge frequency in the positive offset A, depending on Offset Frequency Define settings (Hz) 11. Relative integrated power on the negative offset B (dB) <p>---</p> <ol style="list-style-type: none"> 119. Absolute peak power on the positive offset L (dBm) 120. Peak power offset frequency from the center or carrier edge frequency in the positive offset L, depending on Offset Frequency Define settings (Hz) <p>If the result is not available, NaN (9.91E+37) is returned.</p> <p>The length of the result depends on the number of available offset (See "Number of Offsets" on page 893).</p> <p>The number of values returned is subject to change in future releases.</p>
All	15	<p>Meas Type: Total Power Reference</p> <p>Returns comma-separated scalar results, in the following order:</p> <p>When in the MSR and LTE-Advanced FDD/TDD mode, returns outer offset results when Non-Contiguous Meas Region is set to Outer, and returns inner offset results when it is set to Inner, in the following order.</p> <ol style="list-style-type: none"> 1. Minimum margin from limit line on the negative offset A (dB) 2. Minimum margin from limit line on the positive offset A (dB) 3. Minimum margin from limit line on the negative offset B (dB) 4. Minimum margin from limit line on the positive offset B (dB) <p>---</p> <ol style="list-style-type: none"> 23. Minimum margin from limit line on the negative offset L (dB) 24. Minimum margin from limit line on the positive offset L (dB) <p>If the result is not available, NaN (9.91E+37) is returned.</p> <p>The length of the result depends on the number of available offset (See "Number of Offsets" on page 893).</p> <p>The number of values returned is subject to change in future releases.</p>
MSR, LTEAFDD,	16	

Modes	n	Return Value
LTEATDD only		Returns number of carriers comma-separated scalar results, in the following order: 1. Absolute power of carrier 1 (dBm) 2. Absolute power of carrier 2 (dBm) --- number of carriers-1. Absolute power of carrier (number of carriers)-1 (dBm) number of carriers. Absolute power of carrier (number of carriers)-1 (dBm) If Measure Carrier of the corresponding carrier is no, NaN (9.91E+37) is returned.
WLAN only	16	Returns two carriers comma-separated scalar results when the radio standard is 802.11 ac 80+80 MHz. And returns NaN otherwise. 1. Absolute power of carrier segment 1 (dBm) 2. Absolute power of carrier segment 2 (dBm)
MSR, LTEAFDD, LTEATDD only	17	Returns the displayed frequency domain combined limit trace data separated by comma. Combined trace is a mixed trace of both absolute limit trace and relative limit trace according to the fail mask condition. The number of data points is 2001.

Number of Offsets

The number of available offsets varies depending on the mode and option as below.

Mode	The number of available offsets
MSR, LTEAFDD, LTEATDD	12 (Offset A to L)
WLAN	12 (Offset A to L)
Other modes with option N9060A-7FP	12 (Offset A to L)
Other modes without option N9060A-7FP	6 (Offset A to F)

Key Path	Meas
Initial S/W Revision	Prior to A.02.00
Modified at S/W Revision	A.11.00, A.14.00

AMPTD Y Scale

Accesses a menu of functions that enable you to set the vertical scale parameters. The parameter values are measurement independent except all Attenuation values and Internal Preamp selections that are measurement global.

Key Path	Front-panel key
Initial S/W Revision	Prior to A.02.00

Ref Value

Sets the value for the absolute power reference. However, since Auto Scaling defaults to On, this value is automatically determined by the measurement result. When you set a value manually, Auto Scaling automatically changes to Off.

Key Path	AMPTD Y Scale
Mode	SA, WCDMA, C2K, WIMAX OFDMA, TD-SCDMA, 1xEVDO, DTMB (CTTB), DVB-T/H, ISDB-T, CMMB, LTE, LTETDD, Digital Cable TV, WLAN, MSR, LTEAFDD, LTEATDD
Remote Command	:DISPlay:SEMAsk:VIEW[1]:WINDow[1]:TRACe:Y[:SCALe]:RLEVel <real> :DISPlay:SEMAsk:VIEW[1]:WINDow[1]:TRACe:Y[:SCALe]:RLEVel?
Example	DISP:SEM:VIEW:WIND:TRAC:Y:RLEV 100 DISP:SEM:VIEW:WIND:TRAC:Y:RLEV?
Notes	You must be in the mode that includes SEM measurement to use this command. Use :INSTrument:SElect to set the mode.
Couplings	When the Auto Scaling is On, this value is automatically determined by the measurement result. When you set a value manually, Auto Scaling automatically changed to Off.
Preset	10.0 dBm
State Saved	Saved in instrument state.
Min	-250 dBm
Max	250 dBm
Initial S/W Revision	Prior to A.02.00
Modified at S/W Revision	A.02.00, A.03.00

Range

The Range menu allows setting amplitude controls of the instrument.

Key Path	AMPTD Y Scale
Scope	Meas Global
Initial S/W Revision	A.12.50

Range

Represents the amplitude of the largest sinusoidal signal that could be present within the IF without being clipped by the ADC. For signals with high peak-to-average ratios, the range may need to exceed the rms signal power by a fair amount to avoid clipping.

Key Path	Range
Mode	BASIC
Remote Command	<code>[:SENSe] :POWer [:RF] :RANGe <real></code> <code>[:SENSe] :POWer [:RF] :RANGe?</code>
Example	<code>:POW:RANG 10.0</code> <code>:POW:RANG?</code>
Notes	The MIN and MAX values are affected by the External Gain parameters, and by the Center Frequency. (The hardware compensates for frequency response and alters the Range setting.)
Preset	0
State Saved	Saved in instrument state.
Min	-100
Max	100
Initial S/W Revision	A.12.50

Adjust Range For Min Clip

Sets the combination of attenuation and gain based on the current measured signal level so that clipping will be at a minimum.

This is an "immediate action" function, that is, it executes once, when the key is pressed.

This key is grayed out in measurements that do not support this functionality.

Key Path	AMPTD Y Scale, Attenuation
Remote Command	<code>[:SENSe] :POWer [:RF] :RANGe:OPTimize IMMEDIATE</code>
Initial S/W Revision	Prior to A.02.00
Modified at S/W Revision	A.03.00

Pre-Adjust for Min Clip

If this function is on, it does the adjustment described under Adjust Range For Min Clip each time a measurement restarts. Therefore, in Continuous measurement mode, it only executes before the first measurement.

Key Path	AMPTD Y Scale, Attenuation
Remote Command	<code>[:SENSe] :POWer [:RF] :RANGe:OPTimize:ATTenuation OFF ON ELEctrical COMBined</code>

	<code>[:SENSe] :POWer [:RF] :RANGe :OPTimize :ATTenuation ?</code>
Notes	This parameter is shared with old XA platform which uses AutoAtten. To keep the backward compatibility, ELECTrical and COMBined still can be used. Then, upon receiving ELECTrical and COMBined, these enums will be interpreted as aliases of ON. Then, when queried, ON will be returned.
Preset	OFF for Swept SA measurement; ON for all other measurements that support Pre-Adjust for Min Clip
State Saved	Saved in instrument state
Initial S/W Revision	Prior to A.02.00
Modified at S/W Revision	A.03.00

Peak to Average

The Peak to Average Ratio is used with the Range setting to optimize the level control in the instrument. The value is the ratio, in dB, of the peak power to the average power of the signal to be measured. A ratio of 0 should be used for sinusoidal signals; for 802.11g OFDM signals use 9 dB.

All Applications (Modes) will show the current value of Peak to Average ratio on the softkey. However, some applications will not permit changing the value. In these situations the softkey will be grayed-out.

Key Path	AMPTD Y Scale, Range
Remote Command	<code>[:SENSe] :POWer [:RF] :RANGe :PARatio <real></code> <code>[:SENSe] :POWer [:RF] :RANGe :PARatio ?</code>
Example	POW:RANG:PAR 12 dB
Notes	In some Applications (Modes) this parameter will be read-only; meaning the value will appear on the softkey and query via SCPI, but not changeable. In such applications the softkey will be grayed-out. Attempting to change the value via SCPI will be ignored and no error message will be generated.
Preset	10 dB
State Saved	Saved in instrument state
Min	0 dB
Max	20 dB
Initial S/W Revision	A.13.00

Mixer Level Offset

Mixer level offset is an advanced setting to adjust target Range at the input mixer which in turn affects the signal level in the instrument's IF. This setting can be used when additional optimization is needed after setting Peak to Average ratio. Positive values of offset optimize noise performance over distortion, negative values optimize distortion performance over noise.

Key Path	AMPTD Y Scale, Range
Remote Command	<code>[:SENSe] :POWer [:RF] :RANGe :MIXer :OFFSet <real></code>

	<code>[:SENSe] :POWer [:RF] :RANGe :MIXer :OFFSet ?</code>
Example	POW:RANG:MIX:OFFS -5 dB
Preset	0 dB
State Saved	Saved in instrument state
Min	-35 dB
Max	30 dB
Initial S/W Revision	A.13.00

Scale/Div

Sets the units-per-division of the vertical scale in the logarithmic display. When Auto Scaling is On, the scale per division value is automatically determined by the measurement result. When you set a value manually, Auto Scaling automatically changes to Off.

Key Path	AMPTD Y Scale
Mode	SA, WCDMA, C2K, WIMAX OFDMA, TD-SCDMA, 1xEVDO, DTMB (CTTB), DVB-T/H, ISDB-T, CMMB, LTE, LTE-TDD, Digital Cable TV, WLAN, MSR, LTEAFDD, LTEATDD
Remote Command	<code>:DISPlay:SEMask:VIEW[1]:WINDow[1]:TRACe:Y[:SCALe]:PDIVision <rel_ampl></code> <code>:DISPlay:SEMask:VIEW[1]:WINDow[1]:TRACe:Y[:SCALe]:PDIVision?</code>
Example	DISP:SEM:VIEW:WIND:TRAC:Y:PDIV 15dB DISP:SEM:VIEW:WIND:TRAC:Y:PDIV?
Notes	You must be in the mode that includes SEM measurement to use this command. Use <code>:INSTrument:SElect</code> to set the mode.
Couplings	When the Auto Scaling is On, this value is automatically determined by the measurement result. When you set a value manually, Auto Scaling automatically changes to Off.
Preset	10 dB
State Saved	Saved in instrument state
Min	0.10 dB
Max	20.00 dB
Initial S/W Revision	Prior to A.02.00
Modified at S/W Revision	A.02.00, A.03.00

Ref Position

Positions the reference level at the top, center or bottom of the Y scale display. Changing the reference position does not affect the reference level value.

Key Path	AMPTD Y Scale
Mode	SA, WCDMA, C2K, WIMAX OFDMA, TD-SCDMA, 1xEVDO, DTMB (CTTB), DVB-T/H, ISDB-T, CMMB, LTE, LTE-TDD, Digital Cable TV, WLAN, MSR, LTEAFDD, LTEATDD

Remote Command	:DISPlay:SEMask:VIEW[1]:WINDow[1]:TRACe:Y[:SCALe]:RPOStion TOP CENTer BOTTom :DISPlay:SEMask:VIEW[1]:WINDow[1]:TRACe:Y[:SCALe]:RPOStion?
Example	DISP:SEM:VIEW:WIND:TRAC:Y:RPOS BOTT DISP:SEM:VIEW:WIND:TRAC:Y:RPOS?
Notes	You must be in the mode that includes SEM measurement to use this command. Use :INSTrument:SElect to set the mode.
Preset	TOP
State Saved	Saved in instrument state
Range	Top Ctr Bot
Initial S/W Revision	Prior to A.02.00
Modified at S/W Revision	A.02.00, A.03.00

Auto Scaling

Toggles the Auto Scaling function between On and Off.

When Auto Scaling is On and the Restart front-panel key is pressed, the analyzer automatically determines the scale per division and reference values based on the measurement results. When you set a value to either Scale/Div or Ref Value manually, Auto Scaling automatically changes to Off.

Key Path	AMPTD Y Scale
Mode	SA, WCDMA, C2K, WIMAX OFDMA, TD-SCDMA, 1xEVDO, DTMB (CTTB), DVB-T/H, ISDB-T, CMMB, LTE, LTEFDD, Digital Cable TV, WLAN, MSR, LTEAFDD, LTEATDD
Remote Command	:DISPlay:SEMask:VIEW[1]:WINDow[1]:TRACe:Y[:SCALe]:COUPle 0 1 ON OFF :DISPlay:SEMask:VIEW[1]:WINDow[1]:TRACe:Y[:SCALe]:COUPle?
Example	DISP:SEM:VIEW:WIND:TRAC:Y:COUP OFF DISP:SEM:VIEW:WIND:TRAC:Y:COUP?
Notes	You must be in the mode that includes SEM measurement to use this command. Use :INSTrument:SElect to set the mode.
Couplings	When Auto Scaling is On, upon pressing the Restart front-panel key, this function automatically determines the scale per division and reference values based on the measurement results. When you set a value to either Scale/Div or Ref Value manually, Auto Scaling automatically changes to Off.
Preset	ON
State Saved	Saved in instrument state
Range	On Off
Initial S/W Revision	Prior to A.02.00
Modified at S/W Revision	A.02.00, A.03.00

Auto Couple

The Auto Couple feature provides a quick and convenient way to automatically couple multiple instrument settings. This helps ensure accurate measurements and optimum dynamic range. When the Auto Couple feature is activated, either from the front panel or remotely, all parameters of the current measurement that have an Auto/Manual mode are set to Auto mode and all measurement settings dependent on (or coupled to) the Auto/Man parameters are automatically adjusted for optimal performance.

However, the Auto Couple key actions are confined to the current measurement only. It does not affect other measurements in the mode, and it does not affect markers, marker functions, or trace or display attributes.

See "[More Information](#)" on page 899

Key Path	Front-panel key
Remote Command	:COUPle ALL NONE
Example	:COUP ALL
Notes	:COUPle ALL puts all Auto/Man parameters in Auto mode (equivalent to pressing the Auto Couple key). :COUPLE NONE puts all Auto/Man parameters in manual mode. It decouples all the coupled instrument parameters and is not recommended for making measurements.
Initial S/W Revision	Prior to A.02.00

More Information

There are two types of functions that have Auto/Manual modes.

Auto/Man Active Function keys

An Auto/Man toggle key controls the binary state associated with an instrument parameter by toggling between Auto (where the parameter is automatically coupled to the other parameters it is dependent upon) and Man (where the parameter is controlled independent of the other parameters), as well as making the parameter the active function. The current mode is indicated on the softkey with either Auto or Man underlined as illustrated below.

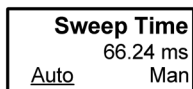

vsd07

Auto/Man 1-of-N keys

An Auto/Man 1-of-N key allows you to manually pick from a list of parameter values, or place the function in Auto, in which case the value is automatically selected (and indicated) as shown below. If in Auto, Auto is underlined on the calling key. If in manual operation, manual is indicated on the calling key. But the calling key does not actually toggle the function, it simply opens the menu.

10 Spectrum Emission Mask Measurement
Auto Couple

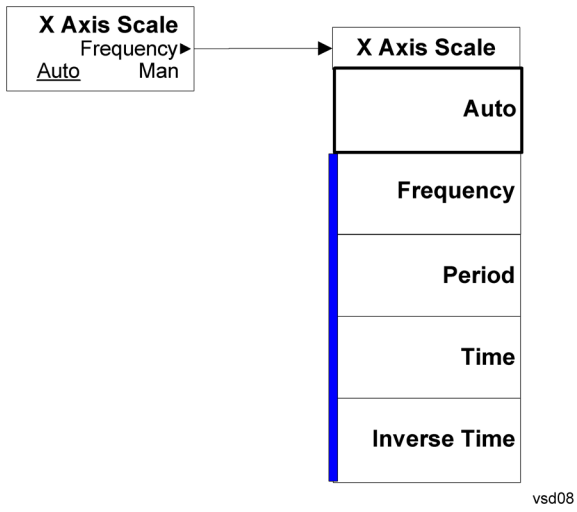

BW

Accesses a menu of functions that enable you to select the type of filter for the measurement.

Key Path	Front-panel key
Initial S/W Revision	Prior to A.02.00
Modified at S/W Revision	A.03.00

Filter Type

Selects the type of bandwidth filter that is used in Carrier and Offsets.

When Gaussian or Flattop is selected, selected filter is applied to carriers and all offsets.

When Auto Sense is selected, filter type is automatically selected for each carriers and offsets, so that measurement speed and accuracy is optimized.

Key Path	BW
Mode	SA, WCDMA, C2K, WIMAX OFDMA, TD-SCDMA, 1xEVDO, DVB-T/H, DTMB (CTTB), ISDB-T, CMMB, LTE, LTE-TDD, Digital Cable TV, WLAN, MSR, LTEAFDD, LTEATDD
Remote Command	[:SENSe] :SEMAsk :BANDwidth :SHAPE ASENse GAUSsian FLATtop [:SENSe] :SEMAsk :BANDwidth :SHAPE?
Example	SEM:BAND:SHAP GAUS SEM:BAND:SHAP?
Couplings	See the description above
Preset	ASENse
State Saved	Saved in instrument state
Range	Auto Sense (each offset and carrier) Gaussian (all offsets and carriers) Flattop (all offsets and carriers)
Initial S/W Revision	A.03.00

Cont (Continuous Measurement/Sweep)

Sets the analyzer for Continuous measurement operation. The single/continuous state is Meas Global so the setting will affect all measurements. If you are Paused, pressing Cont does a Resume.

Key Path	Front-panel key
Remote Command	:INITiate:CONTinuous OFF ON 0 1 :INITiate:CONTinuous?
Example	:INIT:CONT 0 puts analyzer in Single measurement operation. :INIT:CONT 1 puts analyzer in Continuous measurement operation
Preset	ON (Note that SYST:PRESet sets INIT:CONT to ON but *RST sets INIT:CONT to OFF)
State Saved	Saved in instrument state
Backwards Compatibility Notes	For Spectrum Analysis mode in ESA and PSA, there is no Cont hardkey, instead there is a Sweep Single/Cont key. In these analyzers, switching the Sweep Single/Cont key from Single to Cont restarts averages (displayed average count reset to 1), but does not restart Max Hold and Min Hold. The X-Series has Single and Cont keys in place of the SweepSingleCont key. In the X-Series, if in single measurement, the Cont key (and INIT:CONT ON) switches to continuous measurement, but never restarts a measurement and never resets a sweep.
Initial S/W Revision	Prior to A.02.00

In Swept SA Measurement (Spectrum Analysis Mode):

The analyzer takes repetitive sweeps, averages, measurements, etc., when in Continuous mode. When the average count reaches the Average/Hold Number the count stops incrementing, but the analyzer keeps sweeping. See the Trace/Detector section for the averaging formula used both before and after the Average/Hold Number is reached. The trigger condition must be met prior to each sweep. The type of trace processing for multiple sweeps, is set under the Trace/Detector key, with choices of Trace Average, Max Hold, or Min Hold.

In Other Measurements/Modes:

With Avg/Hold Num (in the Meas Setup menu) set to Off or set to On with a value of 1, a sweep is taken after the trigger condition is met; and the analyzer continues to take new sweeps after the current sweep has completed and the trigger condition is again met. However, with Avg/Hold Num set to On with a value >1, multiple sweeps (data acquisitions) are taken for the measurement. The trigger condition must be met prior to each sweep. The sweep is not stopped when the average count k equals the number N set for Avg/Hold Num is reached, but the number k stops incrementing. A measurement average usually applies to all traces, marker results, and numeric results. But sometimes it only applies to the numeric results.

If the analyzer is in Single measurement, pressing the Cont key does not change k and does not cause the sweep to be reset; the only action is to put the analyzer into Continuous measurement operation.

If it is already in continuous sweep:

the INIT:CONT 1 command has no effect

the INIT:CONT 0 command will place the analyzer in Single Sweep but will have no effect on the current sequence until $k = N$, at which point the current sequence will stop and the instrument will go to the idle state.

10 Spectrum Emission Mask Measurement
File

File

See "File" on page 184

FREQ Channel

Accesses a menu of keys that allow you to control the Frequency and Channel parameters of the instrument.

Some features in the Frequency menu are the same for all measurements – they do not change as you change measurements. Settings like these are called “Meas Global” and are unaffected by Meas Preset. For example, the Center Freq setting is the same for all measurements – it does not change as you change measurements.

Key Path	Front-panel key
Initial S/W Revision	Prior to A.02.00

Center Freq

Sets the frequency that corresponds to the horizontal center of the graticule (when frequency Scale Type is set to linear). While adjusting the Center Frequency the Span is held constant, which means that both Start Frequency and Stop Frequency will change.

Pressing Center Freq also sets the frequency entry mode to Center/Span. In Center/Span mode, the center frequency and span values are displayed below the graticule, and the default active function in the Frequency menu is Center Freq.

The center frequency setting is the same for all measurements within a mode, that is, it is Meas Global. Some modes are also able to share a Mode Global center frequency value. If this is the case, the Mode will have a Global Settings key in its Mode Setup menu.

The Center Freq function sets (and queries) the Center Frequency for the currently selected input. If your analyzer has multiple inputs, and you select another input, the Center Freq changes to the value for that input. SCPI commands are available to directly set the Center Freq for a specific input.

Center Freq is remembered as you go from input to input. Thus you can set a Center Freq of 10 GHz with the RF Input selected, change to BBIQ and set a Center Freq of 20 MHz, then switch to External Mixing and set a Center Freq of 60 GHz, and when you go back to the RF Input the Center Freq will go back to 10 GHz; back to BBIQ and it is 20 MHz; back to External Mixing and it is 60 GHz.

See ["RF Center Freq" on page 908](#)

See [Ext Mix Center Freq](#)

See ["I/Q Center Freq" on page 910](#)

See ["Center Frequency Presets" on page 906](#)

Key Path	FREQ Channel
Scope	Meas Global
Remote Command	[:SENSe] :FREQuency:CENTer <freq> [:SENSe] :FREQuency:CENTer?
Example	FREQ:CENT 50 MHz

	FREQ:CENT UP changes the center frequency to 150 MHz if you use FREQ:CENT:STEP 100 MHz to set the center frequency step size to 100 MHz FREQ:CENT?
Notes	This command sets either the RF or I/Q Center Frequency depending on the selected input. For RF input it is equivalent to FREQ:RF:CENT For I/Q input it is equivalent to FREQ:IQ:CENT Preset and Max values are dependent on Hardware Options (5xx) If no terminator (e.g. MHz) is sent the terminator Hz is used. If a terminator with unit other than Frequency is used, an invalid suffix error message is generated.
Dependencies	The Center Frequency can be limited by Start or Stop Freq limits, if the Span is so large that Start or Stop reach their limit.
Couplings	When operating in "swept span", any value of the Center Frequency or Span that is within the frequency range of the analyzer is allowed when the value is being set through the front panel numeric key pad or the SCPI command. The other parameter is forced to a different value if needed, to keep the Start and the Stop Frequencies within the analyzer's frequency range
Preset	Depends on instrument maximum frequency, mode, measurement, and selected input. See " Center Frequency Presets " on page 906 and " RF Center Freq " on page 908 and Ext Mix Center Freq and " I/Q Center Freq " on page 910.
State Saved	Saved in instrument state
Min	Depends on instrument maximum frequency, mode, measurement, and selected input.. See " Center Frequency Presets " on page 906 and " RF Center Freq " on page 908 and " I/Q Center Freq " on page 910.
Max	Depends on instrument maximum frequency, mode, measurement, and selected input.. See " Center Frequency Presets " on page 906 and " RF Center Freq " on page 908 and " I/Q Center Freq " on page 910.
Default Unit	Hz
Status Bits/OPC	Non-overlapped
Dependencies	
Initial S/W Revision	Prior to A.02.00

Center Frequency Presets

The following table provides the Center Frequency Presets for the Spectrum Analyzer mode, and the Max Freq, for the various frequency options:

Freq Option	CF after Mode Preset	Stop Freq after Mode Preset	Max Freq (can't tune above)

503 (all but N9000A)	1.805 GHz	3.6 GHz	3.7 GHz
503 (N9000A)	1.505 GHz	3.0 GHz	3.08 GHz
504 (M9420A)	1 GHz	3.8GHz	3.88 GHz
506 (M9420A)	1 GHz	6.0GHz	6.08 GHz
507 (all but N9000A)	3.505 GHz	7.0 GHz	7.1 GHz
507 (N9000A)	3.755 GHz	7.5 GHz	7.58 GHz
508 (all but N9038A)	1.805 GHz	3.6 GHz	8.5 GHz
508 (N9038A)	4.205 GHz	8.4 GHz	8.5 GHz
513	6.805 GHz	13.6 GHz	13.8 GHz
526 (all but N9000A and N9038A)	13.255 GHz	26.5 GHz	27.0 GHz
526 (N9000A)	13.255 GHz	26.5 GHz	26.55 GHz
526 (N9038A)	1.805 GHz	3.6 GHz	27.0 GHz
532	16.005 GHz	32.0 GHz	32.5 GHz
543	21.505 GHz	43.0 GHz	TBD
544	22.005 GHz	44.0 GHz	44.5 GHz
550	25.005 GHz	50.0 GHz	51 GHz

Input 2:

Model	CF after Mode Preset	Stop Freq after Mode Preset	Max Freq (can't tune above)
N9000A opt C75	0.7505GHz	1.5 GHz	1.58 GHz
N9038A	505 MHz	1 GHz	1.000025 GHz

Tracking Generator Frequency Limits (N9000A only):

Tracking Generator Option	Min Freq (clips to this freq when turn TG on and can't tune below while TG on)	If above this Freq, Stop Freq clipped to this Freq when TG turned on	Max Freq (can't tune above) while TG on
T03	9 kHz	3.0 GHz	3.08 GHz
T06	9 kHz	6.0 GHz	6.05 GHz

The following table shows the Center Frequency Presets for modes other than Spectrum Analyzer:

Mode	CF Preset for RF
WCDMA	1 GHz
WIMAXOFDMA,	1 GHz
BASIC	1 GHz
ADEMOD	1 GHz
VSA	1 GHz
TDSCDMA	1 GHz
PNOISE	1 GHz
LTE	1 GHz
LTETDD	1 GHz
MSR	1 GHz
GSM	935.2 MHz
NFIGURE	1.505 GHz

RF Center Freq

SCPI command for specifying the RF Center Frequency. This command will set the Center Frequency to be used when the RF input is selected, even if the RF input is not the input that is selected at the time the command is sent. Note that the Center Freq function in the Frequency menu on the front panel always applies to the currently selected input.

Scope	Meas Global
Remote Command	<code>[:SENSe] :FREQuency:RF:CENTer <freq></code> <code>[:SENSe] :FREQuency:RF:CENTer?</code>
Example	FREQ:RF:CENT 30 MHz
Notes	This command is the same in all modes, but the parameter is Measurement Global. So the value is independent in each mode and common across all the measurements in the mode.
Dependencies	If the electronic/soft attenuator is enabled, any attempt to set Center Frequency such that the Stop Frequency would be >3.6 GHz fails and results in an advisory message. If the equivalent SCPI

	command is sent, this same message is generated as part of a “-221, Settings conflict” warning. If Source Mode is set to Tracking, and the Max or Min Center Freq is therefore limited by the limits of the source, a warning message is generated, “Data out of range;clipped to source max/min” if these limits are exceeded. Note that for an external source, these limits can be affected by the settings of Source Numerator, Source Denominator and Power Sweep.
Preset	See table above
State Saved	Saved in instrument state.
Min	-79.999995 MHz, unless Source Mode is set to Tracking, in which case it is limited by the minimum frequency of the Source
Max	See table above. Basically instrument maximum frequency - 5 Hz. Note that, if the Source Mode is set to Tracking, the effective instrument maximum frequency may be limited by the source maximum frequency. If the knob or step keys are being used, also depends on the value of the other three interdependent parameters Span, Start Frequency and Stop Frequency
Initial S/W Revision	Prior to A.02.00
Modified at S/W Revision	A.03.00

Ext Mix Center Freq

SCPI command for specifying the External Mixer Center Frequency. This command will set the Center Frequency to be used when the External Mixer is selected, even if the External Mixer input is not the input which is selected at the time the command is sent. Note that the Center Freq function in the Frequency menu on the front panel always applies to the currently selected input.

Scope	Meas Global
Remote Command	<code>[:SENSe] :FREQuency:EMIXer:CENTer <freq></code> <code>[:SENSe] :FREQuency:EMIXer:CENTer?</code>
Example	<code>:FREQ:EMIX:CENT 60 GHz</code> <code>:FREQ:EMIX:CENT?</code>
Notes	This command is the same in all modes, but the parameter is Measurement Global. So the value is independent in each mode and common across all the measurements in the mode.
Couplings	When returning to External Mixing after having been switched to one of the other inputs (e.g., RF), you will come back into the settings that you had when you left External Mixing. So you will come back to the band you were in with the Center Frequency that you had. However, Span is not an input-dependent parameter, therefore you will bring the span over from the other input. Therefore, the analyzer comes back with the span from the previous input, limited as necessary by the current mixer setup.
Preset	When a Mode Preset is performed while in External Mixing, the Start frequency of the current Mode is set to the nominal Min Freq of the lowest harmonic range in the Harmonic Table for the current mixer setup. Similarly, the Stop frequency of the current Mode is set to the nominal Max Freq of the highest harmonic range in the Harmonic Table. The Center Freq thus presets to the point arithmetically equidistant from these two frequencies.

	<p>If the current measurement has a limited Span available to it, and cannot achieve the Span shown in the table (Span=Stop Freq – Start Freq), the analyzer uses the maximum Span the measurement allows, and still sets the Center Freq to the midpoint of the Start and Stop Freq values in the Harmonic Table.</p> <p>When Restore Input/Output Defaults is performed, the mixer presets to the 11970A, whose Start and Stop frequencies are 26.5 and 40 GHz respectively. The center of these two frequencies is 33.25 GHz.</p> <p>Therefore, after a Restore Input/Output Defaults, if you go into External Mixing and do a Mode Preset while in the Spectrum Analyzer Mode, the resulting Center Freq is 33.25 GHz.</p>
State Saved	Saved in instrument state.
Min	The minimum frequency in the currently selected mixer band + 5 Hz
Max	The maximum frequency in the currently selected mixer band – 5 Hz If the knob or step keys are being used, also depends on the value of the other three interdependent parameters Span, Start Frequency and Stop Frequency
Initial S/W Revision	A.08.01

I/Q Center Freq

SCPI command for specifying the I/Q Center Frequency. This command will set the Center Frequency to be used when the I/Q input is selected, even if the I/Q input is not the input which is selected at the time the command is sent. Note that the Center Freq function in the Frequency menu on the front panel always applies to the currently selected input.

Scope	Meas Global
Remote Command	[:SENSe] :FREQuency:IQ:CENTer <freq> [:SENSe] :FREQuency:IQ:CENTer?
Example	FREQ:IQ:CENt: 30 MHz
Notes	This command is the same in all modes, but the parameter is Measurement Global. So the value is independent in each mode and common across all the measurements in the mode.
Preset	0 Hz
State Saved	Saved in instrument state.
Min	-40.049995 MHz
Max	40.049995 MHz
Initial S/W Revision	Prior to A.02.00

CF Step

Changes the step size for the center frequency and start and stop frequency functions. Once a step size has been selected and the center frequency function is active, the step keys (and the UP|DOWN parameters for Center Frequency from remote commands) change the center frequency by the step-size value. The step size function is useful for finding harmonics and sidebands beyond the current frequency span of the analyzer.

Note that the start and stop frequencies also step by the CF Step value.

Key Path	FREQ Channel
Remote Command	[:SENSe]:FREQuency:CENTer:STEP[:INCRement] <freq> [:SENSe]:FREQuency:CENTer:STEP[:INCRement]? [:SENSe]:FREQuency:CENTer:STEP:AUTO OFF ON 0 1 [:SENSe]:FREQuency:CENTer:STEP:AUTO?
Example	FREQ:CENT:STEP:AUTO ON FREQ:CENT:STEP 500 MHz FREQ:CENT UP increases the current center frequency value by 500 MHz FREQ:CENT:STEP? FREQ:CENT:STEP:AUTO?
Notes	Preset and Max values are depending on Hardware Options (503, 507, 508, 513, 526)
Notes	Preset and Max values are dependent on Hardware Options (5xx)
Dependencies	Freq Offset is not available in External Mixing. In this case the Freq Offset key is grayed out and shows a value of zero. It will once again be available, and show the previously set value, when you return to the RF Input.
Dependencies	Span, RBW, Center frequency If the electronic/soft attenuator is enabled, any attempt to change the value of the center frequency >3.6 GHz by pressing the Up-arrow key, fails and results in an advisory message. If the equivalent SCPI command is sent, this same message is generated as part of a “-221, Settings conflict” warning.
Couplings	When auto-coupled in a non-zero span, the center frequency step size is set to 10% of the span. When auto-coupled in zero span, the center frequency step size is set to the equivalent -3 dB RBW value.
Preset	Auto ADEMOD: 1 MHz ON
State Saved	Saved in instrument state
Min	– (the maximum frequency of the instrument). That is, 27 GHz max freq instrument has a CF step range of +/- 27 GHz. Note that this is the maximum frequency given the current settings of the instrument, so in External Mixing, for example, it is the maximum frequency of the current mixer band.
Max	The maximum frequency of the instrument. That is, 27 GHz max freq instrument has a CF step range of +/- 27 GHz. Note that this is the maximum frequency given the current settings of the instrument, so in External Mixing, for example, it is the maximum frequency of the current mixer band.
Default Unit	Hz
Status Bits/OPC dependencies	non-overlapped
Initial S/W Revision	Prior to A.02.00
Modified at S/W Revision	A.03.00

Input/Output

See ["Input/Output" on page 138](#)

Marker

Accesses a menu that enables you to select, set up and control the markers for the current measurement. If there are no active markers, Marker selects marker 1, sets it to Normal and places it at the center of the display. You can turn on and control up to 12 markers.

Key Path	Front-panel key
Initial S/W Revision	Prior to A.02.00

Select Marker

Displays 12 markers available for selection.

Key Path	Marker
Initial S/W Revision	Prior to A.02.00

Marker Type

Sets the marker control mode to Normal and Off. If the selected marker is Off, pressing Marker sets it to Normal and places it at the center of the screen on the trace determined by the Marker Trace rules. At the same time, Marker X Axis Value appears on the Active Function area. The marker X axis value entered in the active function area will display the marker value to its full entered precision. If the current control mode for the measurement is Off, there is no active function and the active function is turned off.

Key Path	Marker
Mode	SA, WCDMA, C2K, WIMAX OFDMA, TD-SCDMA, 1xEVDO, DTMB (CTTB), DVB-T/H, ISDB-T, CMMB, LTE, LTE-TDD, Digital Cable TV, WLAN, MSR, LTEAFDD, LTEATDD
Remote Command	:CALCulate:SEMask:MARKer[1] 2 ... 12:MODE POSITION OFF :CALCulate:SEMask:MARKer[1] 2 ... 12:MODE?
Example	CALC:SEM:MARK:MODE POS CALC:SEM:MARK:MODE?
Notes	If the selected marker is Off, pressing Marker sets it to Normal and places it at the center of the screen on the trace determined by the Marker Trace rules. At the same time, Marker X Axis Value appears on the Active Function area. Default Active Function: the active function for the selected marker's current control mode. Note that if the current control mode is Off, there is no active function and the active function is turned off. Active Function Display: the marker X axis value entered in the active function area will display the marker value to its full entered precision.
Preset	OFF OFF OFF OFF OFF OFF OFF OFF OFF OFF OFF OFF
State Saved	Saved in instrument state
Range	Normal Off
Initial S/W Revision	Prior to A.02.00
Modified at S/W Revision	A.02.00, A.03.00

Couple Markers

When this function is true, moving any marker causes an equal X Axis movement of every other marker that is not Off. By “equal X Axis movement” we mean that we preserve the difference between each marker’s X Axis value (in the fundamental x-axis units of the trace that marker is on) and the X Axis value of the marker being moved (in the same fundamental x-axis units).

Key Path	Marker
Mode	SA, WCDMA, C2K, WIMAX OFDMA, TD-SCDMA, 1xEVDO, DTMB (CTTB), DVB-T/H, ISDB-T, CMMB, LTE, LTE-TDD, Digital Cable TV, WLAN, MSR, LTEAFDD, LTEATDD
Remote Command	:CALCulate:SEMask:MARKer:COUPle[:STATe] ON OFF 1 0 :CALCulate:SEMask:MARKer:COUPle[:STATe]?
Example	CALC:SEM:MARK:COUP ON CALC:SEM:MARK:COUP?
Preset	OFF
State Saved	Saved in instrument state
Range	On Off
Initial S/W Revision	Prior to A.02.00
Modified at S/W Revision	A.02.00, A.03.00

All Markers Off

Turns all active markers off in all views.

Key Path	Marker
Mode	SA, WCDMA, C2K, WIMAX OFDMA, TD-SCDMA, 1xEVDO, DTMB (CTTB), DVB-T/H, ISDB-T, CMMB, LTE, LTE-TDD, Digital Cable TV, WLAN, MSR, LTEAFDD, LTEATDD
Remote Command	:CALCulate:SEMask:MARKer:AOff
Example	CALC:SEM:MARK:AOff
Initial S/W Revision	Prior to A.02.00
Modified at S/W Revision	A.02.00, A.03.00

Marker X Axis Value (Remote Command Only)

Sets the marker X Axis value in the current marker X Axis Scale unit. It has no effect if the control mode is Off, but is the SCPI equivalent of entering an X value if the control mode is Normal.

Mode	SA, WCDMA, C2K, WIMAX OFDMA, TD-SCDMA, 1xEVDO, DTMB (CTTB), DVB-T/H ISDB-T, CMMB, LTE, LTE-TDD, Digital Cable TV, WLAN, MSR, LTEAFDD, LTEATDD
Remote Command	:CALCulate:SEMask:MARKer[1] 2 ... 12:X <freq>

	:CALCulate:SEMask:MARKer[1] 2 ... 12:X?
Example	CALC:SEM:MARK3:X 1.0 GHz CALC:SEM:MARK3:X?
Notes	<p>If no suffix is sent it will use the fundamental units for the current marker X Axis Scale. If a suffix is sent that does not match the current marker X Axis Scale unit, an error "Invalid suffix" will be generated.</p> <p>The query returns the marker's absolute X Axis value if the control mode is Normal. The query is returned in the fundamental units for the current marker X Axis scale. If the marker is Off the response is not a number.</p> <p>When a Marker is turned on, it is placed center of the screen on the trace. Therefore the default value depends on instrument condition, although the Preset/Default is defined as 1.5 GHz.</p>
Preset	After a preset, , all Markers are turned OFF, , so a Marker X Axis Value query will return a not a number (NAN).
State Saved	No
Min	-9.9E+37
Max	9.9E+37
Initial S/W Revision	Prior to A.02.00
Modified at S/W Revision	A.02.00, A.03.00

Marker X Axis Position (Remote Command Only)

Sets the marker X position in trace points. It has no effect if the control mode is Off, but is the SCPI equivalent of entering a value if the control mode is Normal, except in trace points rather than X Axis Scale units. The entered value is immediately translated into the current X Axis Scale units for setting the value of the marker.

Mode	SA, WCDMA, C2K, WIMAX OFDMA, TD-SCDMA, 1xEVDO, DTMB (CTTB), DVB-T/H, ISDB-T, CMMB, LTE, LTETDD, Digital Cable TV, WLAN, MSR, LTEAFDD, LTEATDD
Remote Command	:CALCulate:SEMask:MARKer[1] 2 ... 12:X:POSition <real> :CALCulate:SEMask:MARKer[1] 2 ... 12:X:POSition?
Example	CALC:SEM:MARK10:X:POS 1001 CALC:SEM:MARK10:X:POS?
Notes	<p>The query returns the marker's absolute X Axis value in trace points if the control mode is Normal. The value is returned as a real number, not an integer, corresponding to the translation from X Axis Scale units to trace points . If the marker is Off the response is not a number.</p> <p>When a Marker is turned on, it is placed center of the screen on the trace. Therefore the default value depends on the instrument condition although the Preset/Default is defined as 6507 (this value might be the expected value when all the offsets are on).</p>
Preset	After a preset, , all Markers are turned OFF, , so a Marker X Axis Value query will return a not a number (NAN).
State Saved	No

Min	-9.9E+37
Max	9.9E+37
Initial S/W Revision	Prior to A.02.00
Modified at S/W Revision	A.02.00, A.03.00

Marker Y Axis Value (Remote Command Only)

Returns the marker Y Axis value in the current marker Y Axis unit.

Mode	SA, WCDMA, C2K, WIMAX OFDMA, TD-SCDMA, 1xEVDO, DTMB (CTTB), DVB-T/H, ISDB-T, CMMB, LTE, LTE-TDD, Digital Cable TV, WLAN, MSR, LTEAFDD, LTEATDD
Remote Command	:CALCulate:SEMask:MARKer[1] 2 ... 12:Y?
Example	CALC:SEM:MARK11:Y 10 dBm CALC:SEM:MARK11:Y?
Notes	Since the result value is always calculated from acquisition data, the default value is arbitrary, although the Preset/Default values is defined.
Preset	Result dependent on markers setup and signal source
State Saved	No
Backwards Compatibility SCPI	:CALCulate:SEMask:MARKer[1] 2 ... 12:FUNction:RESult?
Initial S/W Revision	Prior to A.02.00
Modified at S/W Revision	A.02.00, A.03.00

Marker Function

There are no 'Marker Functions' supported in Spectrum Emission Mask so this front-panel key displays a blank menu when pressed.

Key Path	Front-panel key
Initial S/W Revision	Prior to A.02.00

Marker To

There is no 'Marker To' functionality supported in Spectrum Emission Mask so this front-panel key displays a blank menu when pressed.

Key Path	Front-panel key
Initial S/W Revision	Prior to A.02.00

Meas

The information in this section is common to all measurements. For key and remote command information for a specific measurement, refer to the section that describes the measurement of interest.

Measurements available under the Meas key are specific to the current Mode.

When viewing Help for measurements, note the following:

NOTE

Operation for some keys differs between measurements. The information displayed in Help pertains to the current measurement. To see how a key operates in a different measurement, exit Help (press the Cancel Esc key), select the measurement, then reenter Help (press the Help key) and press that key.

Key Path	Front-panel key
Initial S/W Revision	Prior to A.02.00

Remote Measurement Functions

This section contains the following topics:

["Measurement Group of Commands" on page 2016](#)

["Current Measurement Query \(Remote Command Only\)" on page 2018](#)

["Limit Test Current Results \(Remote Command Only\)" on page 2018](#)

["Data Query \(Remote Command Only\)" on page 2018](#)

["Calculate/Compress Trace Data Query \(Remote Command Only\)" on page 2019](#)

["Calculate Peaks of Trace Data \(Remote Command Only\)" on page 2024](#)

["Hardware-Accelerated Fast Power Measurement \(Remote Command Only\)" on page 2025](#)

["Format Data: Numeric Data \(Remote Command Only\)" on page 2039](#)

["Format Data: Byte Order \(Remote Command Only\)" on page 2040](#)

Initial S/W Revision	Prior to A.02.00
----------------------	------------------

Measurement Group of Commands

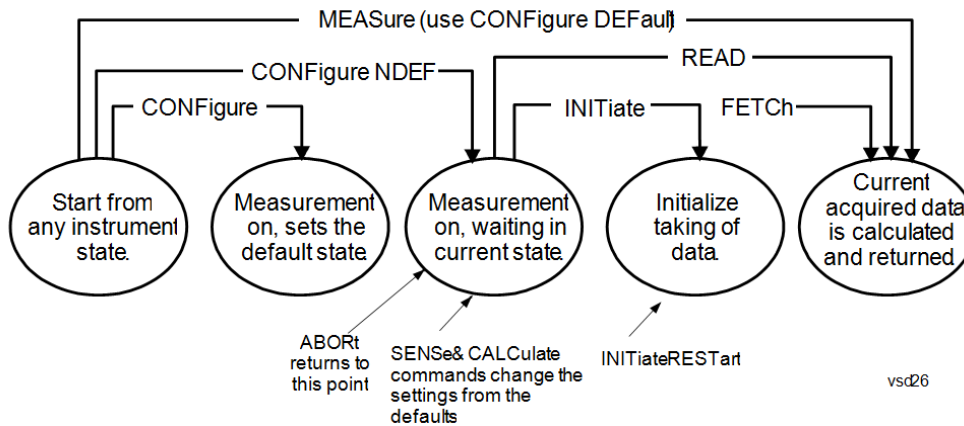

Measure Commands:

:MEASure:<measurement>[n]?

This is a fast single-command way to make a measurement using the factory default instrument settings. These are the settings and units that conform to the Mode Setup settings (e.g. radio standard) that you have currently selected.

- Stops the current measurement (if any) and sets up the instrument for the specified measurement using the factory defaults
- Initiates the data acquisition for the measurement
- Blocks other SCPI communication, waiting until the measurement is complete before returning results.
- If the function does averaging, it is turned on and the number of averages is set to 10.
- After the data is valid it returns the scalar results, or the trace data, for the specified measurement. The type of data returned may be defined by an [n] value that is sent with the command.
- The scalar measurement results will be returned if the optional [n] value is not included, or is set to 1. If the [n] value is set to a value other than 1, the selected trace data results will be returned. See each command for details of what types of scalar results or trace data results are available.
- ASCII is the default format for the data output. (Older versions of Spectrum Analysis and Phase Noise mode measurements only use ASCII.) The binary data formats should be used for handling large blocks of data since they are smaller and faster than the ASCII format. Refer to the FORMat:DATA command for more information.

If you need to change some of the measurement parameters from the factory default settings you can set up the measurement with the CONFigure command. Use the commands in the SENSe:<measurement> and CALCulate:<measurement> subsystems to change the settings. Then you can use the READ? command to initiate the measurement and query the results.

If you need to repeatedly make a given measurement with settings other than the factory defaults, you can use the commands in the SENSe:<measurement> and CALCulate:<measurement> subsystems to set up the measurement. Then use the READ? command to initiate the measurement and query results.

Measurement settings persist if you initiate a different measurement and then return to a previous one. Use READ:<measurement>? if you want to use those persistent settings. If you want to go back to the default settings, use MEASure:<measurement>?.

Configure Commands:

:CONFigure:<measurement>

This command stops the current measurement (if any) and sets up the instrument for the specified measurement using

the factory default instrument settings. It does not initiate the taking of measurement data unless INIT:CONTinuous is ON. If you change any measurement settings after using the CONFigure command, the READ command can be used to initiate a measurement without changing the settings back to their defaults.

In the Swept SA measurement in Spectrum Analyzer mode the CONFigure command also turns the averaging function on and sets the number of averages to 10 for all measurements.

:CONFigure: <measurement>: NDEFault stops the current measurement and changes to the specified measurement. It does not change the settings to the defaults. It does not initiate the taking of measurement data unless INIT:CONTinuous is ON.

The CONFigure? query returns the current measurement name.

The CONFigure:CATalog? query returns a quoted string of all licensed measurement names in the current mode. For example, "SAN, CHP, OBW, ACP, PST, TXP, SPUR, SEM, LIST".

Fetch Commands:

:FETCh:<measurement>[n]?

This command puts selected data from the most recent measurement into the output buffer. Use FETCh if you have already made a good measurement and you want to return several types of data (different [n] values, for example, both scalars and trace data) from a single measurement. FETCh saves you the time of re-making the measurement. You can only FETCh results from the measurement that is currently active, it will not change to a different measurement. An error message is reported if a measurement other than the current one is specified.

If you need to get new measurement data, use the READ command, which is equivalent to an INITiate followed by a FETCh.

The scalar measurement results will be returned if the optional [n] value is not included, or is set to 1. If the [n] value is set to a value other than 1, the selected trace data results will be returned. See each command for details of what types of scalar results or trace data results are available. The binary data formats should be used for handling large blocks of data since they are smaller and transfer faster than the ASCII format. (FORMat:DATA)

FETCh may be used to return results other than those specified with the original READ or MEASure command that you sent.

INITiate Commands:

:INITiate:<measurement>

This command is not available for measurements in all the instrument modes:

- Initiates a trigger cycle for the specified measurement, but does not output any data. You must then use the FETCh<meas> command to return data. If a measurement other than the current one is specified, the instrument will switch to that measurement and then initiate it.
 - For example, suppose you have previously initiated the ACP measurement, but now you are running the channel power measurement. If you send INIT:ACP? it will change from channel power to ACP and will initiate an ACP measurement.
 - Does not change any of the measurement settings. For example, if you have previously started the ACP measurement and you send INIT:ACP? it will initiate a new ACP measurement using the same instrument settings as the last time ACP was run.
 - If your selected measurement is currently active (in the idle state) it triggers the measurement, assuming the trigger conditions are met. Then it completes one trigger cycle. Depending upon the measurement and the number of averages, there may be multiple data acquisitions, with multiple trigger events, for one full trigger cycle. It also holds off additional commands on GPIB until the acquisition is complete.
-

READ Commands:

:READ:<measurement>[n]?

- Does not preset the measurement to the factory default settings. For example, if you have previously initiated the ACP
-

measurement and you send READ:ACP? it will initiate a new measurement using the same instrument settings.

- Initiates the measurement and puts valid data into the output buffer. If a measurement other than the current one is specified, the instrument will switch to that measurement before it initiates the measurement and returns results.
 - For example, suppose you have previously initiated the ACP measurement, but now you are running the channel power measurement. Then you send READ:ACP? It will change from channel power back to ACP and, using the previous ACP settings, will initiate the measurement and return results.
 - Blocks other SCPI communication, waiting until the measurement is complete before returning the results
 - If the optional [n] value is not included, or is set to 1, the scalar measurement results will be returned. If the [n] value is set to a value other than 1, the selected trace data results will be returned. See each command for details of what types of scalar results or trace data results are available. The binary data formats should be used when handling large blocks of data since they are smaller and faster than the ASCII format. (FORMat:DATA)
-

Initial S/W Revision	Prior to A.02.00
----------------------	------------------

Current Measurement Query (Remote Command Only)

This command returns the name of the measurement that is currently running.

Remote Command	:CONFigure?
-----------------------	-------------

Example	CONF?
----------------	-------

Initial S/W Revision	Prior to A.02.00
----------------------	------------------

Limit Test Current Results (Remote Command Only)

Queries the status of the current measurement limit testing. It returns a 0 if the measured results pass when compared with the current limits. It returns a 1 if the measured results fail any limit tests.

Remote Command	:CALCulate:CLIMits:FAIL?
-----------------------	--------------------------

Example	CALC:CLIM:FAIL? queries the current measurement to see if it fails the defined limits. Returns a 0 or 1: 0 it passes, 1 it fails.
----------------	--

Initial S/W Revision	Prior to A.02.00
----------------------	------------------

Data Query (Remote Command Only)

Returns the designated measurement data for the currently selected measurement and subopcode.

n = any valid subopcode for the current measurement. See the measurement command results table for your current measurement, for information about what data is returned for the subopcodes.

This command uses the data setting specified by the FORMat:BORDER and FORMat:DATA commands and can return real or ASCII data. (See the format command descriptions under Input/Output in the Analyzer Setup section.)

Remote Command	:CALCulate:DATA[n]?
Notes	The return trace depends on the measurement. In CALCulate:<meas>:DATA[n], n is any valid subopcode for the current measurement. It returns the same data as the FETCH:<measurement>? query where <measurement> is the current measurement.
Initial S/W Revision	Prior to A.02.00

Calculate/Compress Trace Data Query (Remote Command Only)

Returns compressed data for the currently selected measurement and sub-opcode [n].

n = any valid sub-opcode for that measurement. See the MEASure:<measurement>? command description of your specific measurement for information on the data that can be returned.

The data is returned in the current Y Axis Unit of the analyzer. The command is used with a sub-opcode <n> (default=1) to specify the trace. With trace queries, it is best if the analyzer is not sweeping during the query. Therefore, it is generally advisable to be in Single Sweep, or Update=Off.

This command is used to compress or decimate a long trace to extract and return only the desired data. A typical example would be to acquire N frames of GSM data and return the mean power of the first burst in each frame. The command can also be used to identify the best curve fit for the data.

Remote Command	:CALCulate:DATA<n>:COMPRESS? BLOCK CFIT MAXimum MINimum MEAN DMEan RMS RMSCubed SAMPLE SDEViation PPHase [,<soffset> [,<length>[,<roffset>[,<rlimit>]]]]
Example	To query the mean power of a set of GSM bursts: Supply a signal that is a set of GSM bursts. Select the IQ Waveform measurement (in IQ Analyzer Mode). Set the sweep time to acquire at least one burst. Set the triggers such that acquisition happens at a known position relative to a burst. Then query the mean burst levels using, CALC:DATA2:COMP? MEAN, 24e-6, 526e-6 (These parameter values correspond to GSM signals, where 526e-6 is the length of the burst in the slot and you just want 1 burst.)
Notes	The command supports 5 parameters. Note that the last 4 (<soffset>, <length>, <roffset>, <rlimit>) are optional. But these optional parameters must be entered in the specified order. For example, if you want to specify <length>, then you must also specify <soffset>. See details below for a definition of each of these parameters. This command uses the data in the format specified by FORMat:DATA, returning either binary or ASCII data.
Initial S/W Revision	Prior to A.02.00

- BLOCK or block data - returns all the data points from the region of the trace data that you specify. For example, it could be used to return the data points of an input signal over several timeslots, excluding the portions of the trace data that you do not want. (This is x,y pairs for trace data and I,Q pairs for complex data.)

- CFIT or curve fit - applies curve fitting routines to the data. <soffset> and <length> are required to define the data that you want. <roffset> is an optional parameter for the desired order of the curve equation. The query will return the following values: the x-offset (in seconds) and the curve coefficients ((order + 1) values).

MIN, MAX, MEAN, DME, RMS, RMSC, SAMP, SDEV and PPH return one data value for each specified region (or <length>) of trace data, for as many regions as possible until you run out of trace data (using <roffset> to specify regions). Or they return the number of regions you specify (using <rlimit>) ignoring any data beyond that.

- MINimum - returns the minimum data point (y value) for the specified region(s) of trace data. For I/Q trace data, the minimum magnitude of the I/Q pairs is returned.
- MAXimum - returns the maximum data point (y value) for the specified region(s) of trace data. For I/Q trace data, the maximum magnitude of the I/Q pairs is returned.
- MEAN - returns a single value that is the arithmetic mean of the data point values (in dB/ dBm) for the specified region(s) of trace data. For I/Q trace data, the mean of the magnitudes of the I/Q pairs is returned. See the following equations.

•

NOTE

If the original trace data is in dB, this function returns the arithmetic mean of those log values, not log of the mean power which is a more useful value. The mean of the log is the better measurement technique when measuring CW signals in the presence of noise. The mean of the power, expressed in dB, is useful in power measurements such as Channel Power. To achieve the mean of the power, use the RMS option.

Equation 1

Mean Value of Data Points for Specified Region(s)

$$\text{MEAN} = \frac{1}{n} \sum_{X_i \in \text{region}(s)} X_i$$

where X_i is a data point value, and n is the number of data points in the specified region(s).

Equation 2

Mean Value of I/Q Data Pairs for Specified Region(s)

$$\text{MEAN} = \frac{1}{n} \sum_{X_i \in \text{region}(s)} |X_i|$$

where $|X_i|$ is the magnitude of an I/Q pair, and n is the number of I/Q pairs in the specified region(s).

- DMEan - returns a single value that is the mean power (in dB/ dBm) of the data point values for the specified region(s) of trace data. See the following equation:

Equation 3

DMEan Value of Data Points for Specified Region(s)

$$\text{DME} = 10 \times \log_{10} \left(\frac{1}{n} \sum_{X_i \in \text{region}(s)} 10^{\frac{X_i}{10}} \right)$$

- RMS - returns a single value that is the average power on a root-mean-squared voltage scale (arithmetic rms) of the data point values for the specified region(s) of trace data. See the following equation.

NOTE For I/Q trace data, the rms of the magnitudes of the I/Q pairs is returned. See the following equation. This function is very useful for I/Q trace data. However, if the original trace data is in dB, this function returns the rms of the log values which is not usually needed.

Equation 4

RMS Value of Data Points for Specified Region(s)

$$\text{RMS} = \sqrt{\frac{1}{n} \sum_{X_i \in \text{region}(s)} X_i^2}$$

where X_i is a data point value, and n is the number of data points in the specified region(s).

Equation 5

RMS Value of I/Q Data Pairs for Specified Region(s)

$$\text{RMS} = \sqrt{\frac{1}{n} \sum_{X_i \in \text{region}(s)} X_i X_i^*}$$

where X_i is the complex value representation of an I/Q pair, X_i^* its conjugate complex number, and n is the number of I/Q pairs in the specified region(s).

Once you have the rms value for a region of trace data (linear or I/Q), you may want to calculate the mean power. You must convert this rms value (peak volts) to power in dBm:

$$10 \times \log[10 \times (\text{rms value})^2]$$

- SAMPLe - returns the first data value (x,y pair) for the specified region(s) of trace data. For I/Q trace data, the first I/Q pair is returned.
- SDEViation - returns a single value that is the arithmetic standard deviation for the data point values for the specified region(s) of trace data. See the following equation.
- For I/Q trace data, the standard deviation of the magnitudes of the I/Q pairs is returned. See the following equation.

Equation 6

Standard Deviation of Data Point Values for Specified Region(s)

$$\text{SDEV} = \sqrt{\frac{1}{n} \sum_{X_i \in \text{region}(s)} (X_i - \bar{X})^2}$$

where X_i is a data point value, \bar{X} is the arithmetic mean of the data point values for the specified region (s), and n is the number of data points in the specified region(s).

$$\text{SDEV} = \sqrt{\frac{1}{n} \sum_{X_i \in \text{region}(s)} (|X_i| - \bar{X})^2}$$

where $|X_i|$ is the magnitude of an I/Q pair, \bar{X} is the mean of the magnitudes for the specified region(s), and n is the number of data points in the specified region(s).

- PPHase - returns the x,y pairs of both rms power (dBm) and arithmetic mean phase (radian) for every specified region and frequency offset (Hz). The number of pairs is defined by the specified number of regions. This parameter can be used for I/Q vector (n=0) in Waveform (time domain) measurement and all parameters are specified by data point in PPHase.

The rms power of the specified region may be expressed as:

$$\text{Power} = 10 \times \log [10 \times (\text{RMS I/Q value})] + 10.$$

The RMS I/Q value (peak volts) is:

$$\sqrt{\frac{1}{n} \sum_{X_i \in \text{region}} X_i X_i^*}$$

where X_i is the complex value representation of an I/Q pair, X_i^* its conjugate complex number, and n is the number of I/Q pairs in the specified region.

The arithmetic mean phase of the specified region may be expressed as:

$$\frac{1}{n} \sum_{Y_i \in \text{region}} Y_i$$

where Y_i is the unwrapped phase of I/Q pair with applying frequency correction and n is the number of I/Q pairs in the specified region.

The frequency correction is made by the frequency offset calculated by the arithmetic mean of every specified region's frequency offset. Each frequency offset is calculated by the least square method against the unwrapped phase of I/Q pair.

Sample Trace Data - Constant Envelope

(See below for explanation of variables.)

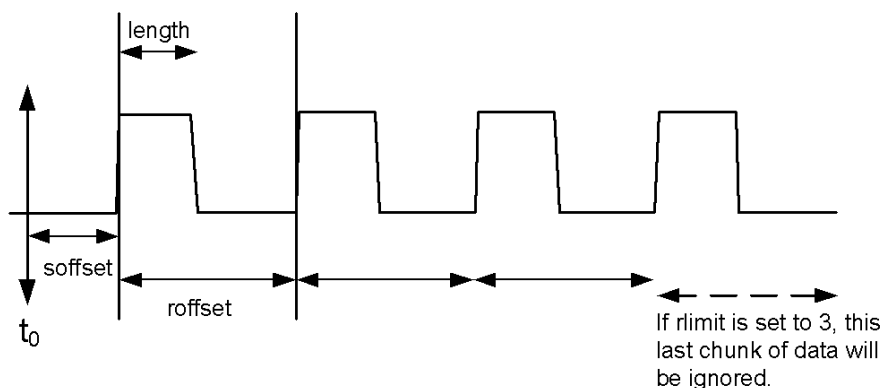

Sample Trace Data - Not Constant Envelope

(See below for explanation of variables.)

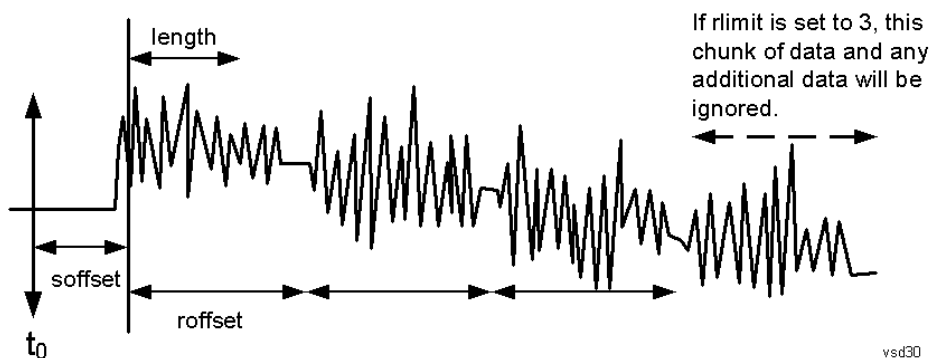

<soffset> - start offset is an optional real number. (It is in seconds for time-domain traces, and is a dimensionless index 0 to Npoints - 1, for frequency-domain traces). It specifies the amount of data at the beginning of the trace that will be ignored before the decimation process starts. It is the time or frequency change from the start of the trace to the point where you want to start using the data. The default value is zero.

<length> - is an optional real number. (It is in seconds for time-domain traces, and is a dimensionless index 0 to Npoints - 1, for frequency-domain traces). It defines how much data will be compressed into one value. This parameter has a default value equal to the current trace length.

<roffset> - repeat offset is an optional real number. (It is in seconds for time-domain traces, and is a dimensionless index 0 to Npoints - 1, for frequency-domain traces). It defines the beginning of the next field of trace elements to be compressed. This is relative to the beginning of the previous field. This parameter has a default value equal to the <length> variable. Note that this parameter is used for a completely different purpose when curve fitting (see CFIT above).

<rlimit> - repeat limit is an optional integer. It specifies the number of data items that you want returned. It will ignore any additional items beyond that number. You can use the Start offset and the Repeat limit to pick out exactly what part of the data you want to use. The default value is all the data.

Calculate Peaks of Trace Data (Remote Command Only)

Returns a list of all the peaks for the currently selected measurement and sub-opcode [n]. The peaks must meet the requirements of the peak threshold and excursion values.

n = any valid sub-opcode for the current measurement. See the MEASure:<measurement> command description of your specific measurement for information on the data that can be returned.

The command can only be used with specific sub-opcodes with measurement results that are trace data. Both real and complex traces can be searched, but complex traces are converted to magnitude in dBm. In many measurements the sub-opcode n=0, is the raw trace data which cannot be searched for peaks. And Sub-opcode n=1, is often calculated results values which also cannot be searched for peaks.

This command uses the data setting specified by the FORMat:BORDER and FORMat:DATA commands and can return real or ASCII data. If the format is set to INT,32, it returns REAL,32 data.

The command has four types of parameters:

- Threshold (in dBm)
- Excursion (in dB)
- Sorting order (amplitude, frequency, time)
- Optional in some measurements: Display line use (all, > display line, < display line)

Remote Command	<p>For Swept SA measurement:</p> <pre>:CALCulate:DATA[1] 2 ... 6:PEAKs? <threshold>,<excursion>[,AMPLitude FREQuency TIME[,ALL GTDLine LTDLine]]</pre> <p>For most other measurements:</p> <pre>:CALCulate:DATA[1] 2 ... 6:PEAKs? <threshold>,<excursion>[,AMPLitude FREQuency TIME]</pre>
Example	<p>Example for Swept SA measurement in Spectrum Analyzer Mode:</p> <p>CALC:DATA4:PEAK? -40, 10, FREQ, GTDL This will identify the peaks of trace 4 that are above -40 dBm, with excursions of at least 10 dB. The peaks are returned in order of increasing frequency, starting with the lowest frequency. Only the peaks that are above the display line are returned.</p> <p>Query Results 1:</p> <p>With FORMat:DATA REAL, 32 selected, it returns a list of floating-point numbers. The first value in the list is the number of peak points that are in the following list. A peak point consists of two values: a peak amplitude followed by its corresponding frequency (or time).</p> <p>If no peaks are found the peak list will consist of only the number of peaks, (0).</p>
Notes	<p><n> - is the trace that will be used</p> <p><threshold> - is the level below which trace data peaks are ignored. Note that the threshold value is required and is always used as a peak criterion. To effectively disable the threshold criterion for this command, provide a substantially low threshold value such as -200 dBm. Also note that the threshold value used in this command is independent of and has no effect on the threshold value stored under the Peak Criteria menu.</p> <p><excursion> - is the minimum amplitude variation (rise and fall) required for a signal to be identified as peak. Note that the excursion value is required and is always used as a peak criterion. To effectively disable the excursion criterion for this command, provide the minimum value of 0.0 dB. Also note that the excursion value used in this command is independent of and has no effect on the</p>

excursion value stored under the Peak Criteria menu.

Values must be provided for threshold and excursion. The sorting and display line parameters are optional (defaults are AMPLitude and ALL).

Note that there is always a Y-axis value for the display line, regardless of whether the display line state is on or off. It is the current Y-axis value of the display line which is used by this command to determine whether a peak should be reported. Sorting order:

AMPLitude - lists the peaks in order of descending amplitude, with the highest peak first (default if optional parameter not sent)

FREQuency - lists the peaks in order of occurrence, left to right across the x-axis.

TIME - lists the peaks in order of occurrence, left to right across the x-axis.

Peaks vs. Display Line:

ALL - lists all of the peaks found (default if optional parameter not sent).

GTDLine (greater than display line) - lists all of the peaks found above the display line.

LTDLine (less than display line) - lists all of the peaks found below the display line.

Initial S/W Revision	Prior to A.02.00
----------------------	------------------

Hardware-Accelerated Fast Power Measurement (Remote Command Only)

The Fast Power option (FP2) enables very fast channel power measurements for instruments with the prerequisite hardware (DP2 and/or B40). It accomplishes this by performing real-time overlapped FFTs at the hardware layer, using software for basic post-processing before returning the result to the user. The upshot of this approach is improved throughput for user applications that require many sequential power measurements.

The analysis bandwidth of FP2 is limited by the licenses in the instrument, but its maximum overall analysis bandwidth per acquisition is 40 MHz.

FP2 is remote-only, which means the instrument does not switch to any particular mode or measurement. FP2 commands can be sent while another application is in use on the front panel.

Each Fast Power measurement can be predefined using an array index, and up to 1,000 measurements can be stored. In the following documentation, instances of [1,2,...,999] can be substituted with a particular measurement index, e.g. CALC:FPOW:POW1?, CALC:FPOW:POW2?, CALC:FPOW:POW134?. In this way, power measurements can be defined one time in a batch, and then executed multiple times without having to redefine them, similar to “list mode” on other measurements.

In addition to basic channel power measurements, there are a number of other measurement “functions” for each channel, including peak power, peak frequency, and power spectral density. See the Function parameter for more information.

Reset Fast Power Measurement (Remote Command Only)

Resets the measurement configuration to the defaults.

Mode	All
Remote Command	:CALCulate:FPOWer:POWer [1, 2, ..., 999] :RESet
Example	:CALC:FPOW:POW1:RES

Notes	Option FP2 is required.
Initial S/W Revision	A.14.00

Define Fast Power Measurement (Remote Command Only)

Fast Power acquisitions are configured using the DEFine command. This command accepts a comma-delimited string of configuration parameters and their appropriate values, which are all specified in the subsection below.

Mode	All
Remote Command	:CALCulate:FPOWer:POWer[1,2,...,999]:DEFine "configuration string"
Example	:CALC:FPOW:POW1:DEF "CenterFrequency=2e9, AcquisitionTime=0.005"
Notes	See below for a list of measurement variables that can be defined in the configuration string.
Initial S/W Revision	A.14.00

Acquisition Time

Example	CALC:FPOW:POW1:DEF "AcquisitionTime=0.002"
Notes	The acquisition time parameter sets the time in which the entire spectrum is measured. An increase in the acquisition time yields an improvement in measurement repeatability.
Preset	0.001 s
Range	0 s to 1 s
Default Unit	Time (s)
Initial S/W Revision	A.14.00

Center Frequency

Example	CALC:FPOW:POW1:DEF "CenterFrequency=2e9"
Notes	The center frequency parameter sets the frequency in which the measurement is centered around. The OffsetFrequency parameter is calculated relative to the center frequency.
Preset	1 GHz
Range	0 Hz to maximum instrument frequency
Default Unit	Frequency (Hz)
Initial S/W Revision	A.14.00

DC Coupled

Example	CALC:FPOW:POW1:DEF "DCCoupled=True"
Notes	The DC coupled parameter allows the user to specify whether the DC blocking capacitor is utilized. Set parameter to true when measuring frequencies below 10 MHz.
Preset	False
Range	True (DC Coupled) or False (AC Coupled)
Default Unit	Boolean
Initial S/W Revision	A.14.00

DetectorType

Example	CALC:FPOW:POW1:DEF "DetectorType=Peak"
Notes	Option FP2 is required. The detector type parameter allows the user to choose whether a RMS average or peak value is used during the measurement.
Preset	RmsAverage
Range	RmsAverage, Peak
Initial S/W Revision	A.14.00

Do Noise Correction

Example	CALC:FPOW:POW1:DEF "DoNoiseCorrection=True"
Notes	When noise correction is enabled, the linear noise power contributed by the analyzer is subtracted from all measurements. This effectively lowers the noise floor of the analyzer. When noise correction is enabled, the first measurement for a given set of input parameters will take extra time. This is because the analyzer takes an extra acquisition with the RF input disconnected from the analyzer's front end to measure the noise of just the analyzer. The measured noise floor is stored in a cache so the noise acquisition will occur only once for the same state settings. In other words, if noise correction was turned on and the analyzer made an acquisition at frequency A, then frequency B, and back again to frequency A, the hidden initial noise floor acquisition would only occur for the first acquisition at frequency A and the cached noise floor would be used the second time frequency A was measured.
Preset	False
Range	True (enable noise correction) or False (disable noise correction)
Default Unit	Boolean
Initial S/W Revision	A.14.00

Do Spur Suppression

Example	CALC:FPOW:POW1:DEF "DoSpurSuppression=True"
Notes	<p>When measuring very low level signals, or when large out-of-band inputs are input into the analyzer, sometimes unwanted spurs and residuals can appear in the measured spectrum. Spur suppression is a method to help minimize the levels of these internally generated spurs and residuals.</p> <p>When spur suppression is enabled, the analyzer will automatically take two acquisitions using two different internal analog LO frequencies. The FFT spectrums from both acquisitions are combined by taking the minimum power between both traces on a per FFT bin basis. External signals will have the same amplitude for both traces and therefore will return the expected amplitudes. However, low level spurs and residuals generated internally to the analyzer tend to move to different FFT bins depending on the internal analog LO frequency used, and therefore tend to be suppressed using this spur suppression method.</p> <p>Because two acquisitions, rather than a single acquisition, are made when spur suppression is enabled, the measurement time will always be slower when spur suppression is enabled.</p>
Preset	False
Range	True (enable spur suppression) or False (disable spur suppression)
Default Unit	Boolean
Initial S/W Revision	A.14.00

Electronic Attenuator Bypass

Example	CALC:FPOW:POW1:DEF "ElecAttBypass =False"
Notes	The electronic attenuation bypass parameter allows the user to either utilize or bypass the electronic attenuator. The electronic attenuator is only available for frequencies up to 3.6 GHz. Set parameter to true when using frequencies above 3.6 GHz and set the parameter to false when using the preamp.
Preset	True
Range	True (bypass electronic attenuator) or False (use electronic attenuator)
Default Unit	Boolean
Initial S/W Revision	A.14.00

Electronic Attenuation

Example	CALC:FPOW:POW1:DEF "ElecAttenuation=10"
Notes	<p>Option EA3 is required.</p> <p>The electronic attenuation value parameter sets the amount of electrical attenuation from 0 to 24 dB (1 dB steps).</p> <p>Set "ElecAttBypass=False" to make sure the electronic attenuator path is enabled.</p>
Preset	0 dB
Range	0 - 24 dB (1 dB steps)

Default Unit	dB
Initial S/W Revision	A.14.00

IF Gain

Example	CALC:FPOW:POW1:DEF "IFGain=10"
Notes	The IF gain parameter allows the user to specify the gain at the IF stage anywhere from -6 to 16 dB (1 dB steps). This is an advanced feature, and for most cases this should remain at its default value of 0 dB.
Preset	0 dB
Range	-6 - 16 dB (1 dB steps)
Default Unit	dB
Initial S/W Revision	A.14.00

IF Type

Example	CALC:FPOW:POW1:DEF "IFType=B25M"
Notes	The IF type parameter allows the user to select between different IF paths. For example, if the signal is less than 25 MHz wide, then the user can select the B25M path to take advantage of additional filtering on this analog IF path.
Preset	B40M
Range	B10M, B25M, B40M
Initial S/W Revision	A.14.00

Include Power Spectrum

Example	CALC:FPOW:POW1:DEF "IncludePowerSpectrum=True"
Notes	The power spectrum parameter allows the user to read data on the entire spectrum for diagnostic purposes. It is not recommended for production use. See CALC:FPOW:POW[n]:READ2? for details on the binary format of the response.
Preset	False
Range	True (return both channel power and full power spectrum) or False (returns only channel power)
Default Unit	Boolean
Initial S/W Revision	A.14.00

Mechanical Attenuation

Example	CALC:FPOW:POW1:DEF "MechAttenuation=10"
Notes	The mechanical attenuation value parameter sets the amount of mechanical attenuation anywhere from 0 to 70 dB (2 dB steps).
Preset	0 dB
Range	0 – 70 dB (2 dB steps)
Default Unit	dB
Initial S/W Revision	A.14.00

Preamp Mode

Example	CALC:FPOW:POW1:DEF "PreAmpMode=Low"
Notes	The license for the appropriate preamp is required. The preamp mode parameter specifies whether the preamps are being utilized. Low allows any preamps up to 3.6 GHz, and Full allows all licensed preamps. Set "ElecAttBypass=True" in order to utilize any preamps.
Preset	Off
Range	Off, Low, Full
Initial S/W Revision	A.14.00

Resolution Bandwidth Mode

Example	CALC:FPOW:POW1:DEF "PreAmpMode=Low"
Notes	The resolution bandwidth mode parameter allows the user to choose whether the RBW filter is automatically or manually set. The BestSpeed value minimizes measurement time, while the Narrowest value minimizes RBW size (minimum of two FFT bins per RBW). To manually specify an RBW, set this parameter to Explicit, and set the ResolutionBW parameter to the desired value.
Preset	BestSpeed
Range	BestSpeed, Narrowest, Explicit
Initial S/W Revision	A.14.00

Resolution Bandwidth

Example	CALC:FPOW:POW1:DEF "ResolutionBW=25e3"
Notes	The resolution bandwidth parameter sets the 3-dB bandwidth of the RBW filter. The ResolutionBWMode parameter must be set to Explicit in order to manually set the RBW.

Preset	0 Hz
Default Unit	Hz
Initial S/W Revision	A.14.00

Trigger Delay

Example	CALC:FPOW:POW1:DEF "TriggerDelay=0.025"
Notes	The trigger delay parameter sets the time after an external trigger is detected until the measurement is performed.
Preset	0 s
Range	0 - 1 s
Default Unit	Seconds
Initial S/W Revision	A.14.00

Trigger Level

Example	CALC:FPOW:POW1:DEF "TriggerLevel=2"
Notes	The trigger level parameter sets the voltage value at which an external trigger is detected.
Preset	1.2 V
Range	-5 to 5 V
Default Unit	Volts
Initial S/W Revision	A.14.00

Trigger Slope

Example	CALC:FPOW:POW1:DEF "TriggerSlope=Negative"
Notes	The trigger slope parameter indicates the direction of the edge trigger voltage for detection.
Preset	Positive
Range	Positive, Negative
Initial S/W Revision	A.14.00

Trigger Source

Example	CALC:FPOW:POW1:DEF "TriggerSource=Ext1"
Notes	The trigger source parameter allows the user to choose between measurement's triggering freely or controlled by an external input. Ext1 and Ext2 correspond to Trigger 1 In and Trigger 2 In, respectively.
Preset	Free
Range	Free, Ext1, Ext2
Initial S/W Revision	A.14.00

Trigger Timeout

Example	CALC:FPOW:POW1:DEF "TriggerTimeout=0.1"
Notes	The trigger timeout parameter sets the time in which the analyzer will wait for a trigger before automatically performing the measurement.
Preset	1 s
Range	0 – 1 s
Default Unit	Seconds
Initial S/W Revision	A.14.00

Signal Input

Example	CALC:FPOW:POW1:DEF "SignalInput=Fp50MHzCW"
Notes	The signal input parameter allows the user to select between using the main RF input or the internal analyzer reference CW signal of 50 MHz.
Preset	FpMainRf
Range	FpMainRf, Fp50MHzCW
Initial S/W Revision	A.14.00

Use Preselector

Example	CALC:FPOW:POW1:DEF "UsePreSelector=True"
Notes	The preselector parameter allows the user to either utilize or bypass the front end tunable filter at frequencies above 3.6 GHz. For frequencies below 3.6 GHz, the preselector is automatically bypassed, so you do not need to set this parameter to False in those cases.
Preset	False
Range	True (use preselector above 3.6 GHz), or False (preselector bypassed)

Default Unit	Boolean
Initial S/W Revision	A.14.00

Channel Bandwidth Array

Example	CALC:FPOW:POW1:DEF "Bandwidth=[3.84e6, 5e6, 3.84e6]"
Notes	The bandwidth parameter array defines the bandwidth of each channel that will be measured. All array parameters should have the same number of elements. Alternatively, if all the elements are the same value, a single number with no square brackets can be used to define the parameter.
Preset	[1e6]
Range	0 to 40 MHz
Default Unit	Hz
Initial S/W Revision	A.14.00

Channel Filter Type Array

Example	CALC:FPOW:POW1:DEF "FilterType=[RRC, IBW, RRC]"
Notes	The filter type parameter allows the user to choose between an integration bandwidth (IBW) filter or a root-raised-cosine (RRC) filter. The integration bandwidth filter weighs all frequencies within the bandwidth equally. The root-raised-cosine filter has an associated shape parameter, defined by the FilterAlpha parameter. All array parameters should have the same number of elements. Alternatively, if all the elements are the same value, a single value with no square brackets can be used to define the parameter.
Preset	[IBW]
Range	IBW, RRC
Initial S/W Revision	A.14.00

Channel Filter Alpha Array

Example	CALC:FPOW:POW1:DEF "FilterAlpha=[0.5, 0.0, 0.5]"
Notes	The filter alpha parameter allows the user to adjust the alpha value associated with the root-raised-cosine (RRC) filter type. Set FilterType to RRC in order to utilize this parameter. All array parameters should have the same number of elements. Alternatively, if all the elements are the same value, a single number with no square brackets can be used to define the parameter.
Preset	[0.22]
Range	0.0 - 1.0

Initial S/W Revision	A.14.00
-------------------------	---------

Channel Measurement Function Array

Example	CALC:FPOW:POW1:DEF "Function=[BandPower, PeakPower, BandPower]"
Notes	<p>This parameter array defines what measurement is being made for each individually-specified channel:</p> <p>BandPower: Total power within the specified bandwidth of the channel (dBm)</p> <p>BandDensity: Total power density within the specified bandwidth of the channel (dBm/Hz)</p> <p>PeakPower: The peak power value within the specified bandwidth of the channel (dBm)</p> <p>PeakFrequency: The frequency which corresponds to the peak power value within the specified bandwidth of the channel. This frequency is relative to the center frequency (Hz)</p> <p>XdBBandwidth: The half power (-3.01 dB) bandwidth of the highest amplitude signal that resides within the channel (Hz), dB is configurable using XdBBandwidth parameter</p> <p>OccupiedBandwidth: The bandwidth at which 99% of the total power resides within the channel (Hz), percentage configurable using OccupiedBandwidthPercent parameter</p> <p>All array parameters should have the same number of elements. Alternatively, if all the elements are the same value, a single value with no square brackets can be used to define the parameter.</p>
Preset	[BandPower]
Range	BandPower, BandDensity, PeakPower, PeakFrequency, XdBBandwidth, OccupiedBandwidth
Initial S/W Revision	A.14.00

Channel Offset Frequency Array

Example	CALC:FPOW:POW1:DEF "OffsetFrequency=[-5e6, 0, 5e6]"
Notes	<p>The offset frequency parameter array defines the difference between the center frequency to the center frequency of each channel.</p> <p>All array parameters should have the same number of elements.</p>
Preset	[0]
Range	0 to 20 MHz
Default Unit	Hz
Initial S/W Revision	A.14.00

Channel Occupied Bandwidth Percent Array

Example	CALC:FPOW:POW1:DEF "OccupiedBandwidthPercent =[0.95, 0.95, 0.95]"
Notes	This parameter only applies for channels whose Function is set to OccupiedBandwidth. The occupied

	bandwidth percent parameter specifies the percent of total power in these channels. The valid range for this parameter is 0.0 to 1.0, where 1.0 represents 100%. The default for this parameter is 0.99, which will return the bandwidth that contains 99% of the total channel power.
Preset	[0.99]
Range	0 - 1.0
Initial S/W Revision	A.14.00

Channel x-dB Bandwidth Array

Example	CALC:FPOW:POW1:DEF " XdBBandwidth =[-6.02, -3.01, -1.0]"
Notes	This parameter only applies for channels whose Function is set to XdBBandwidth. The X dB bandwidth parameter is used to specify the power relative to the peak channel power over which the bandwidth is calculated. The parameter value must be a negative number.
Preset	[-3.01]
Range	-200 to 0 dB
Default Unit	dB
Initial S/W Revision	A.14.00

Define Fast Power Measurement Query (Remote Command Only)

The DEFine? command is used to retrieve a list of all defined parameters in an ASCII string format

```

M All
o
d
e
-----
R :CALCulate:FPOWer:POWer[1,2,...,999]:DEFine?
e
m
o
t
e
C
o
m
m
a
n
d
-----
E :CALC:FPOW:POW1:DEF?

```

x
a
m
p
l
e

N This command query is used to retrieve a list of all defined parameters in an ASCII format.

O The following is an example of the returned results:

S "DCCoupled=False,ElecAttBypass=True,ElecAttenuation=0,IFGain=0,MechAttenuation=0,PreAmpMode=Off,PreSelectorOffset=0,UsePreSelector=False,ExternalReferenceFrequency=1000000,FrequencyReferenceSource=AutoExternalFrequencyReference,IFType=B40M,LOMode=SLW,SignalInput=FpMainRf,AcquisitionTime=0.001,CenterFrequency=100000000,ResolutionBW=0,ResolutionBWMode=BestSpeed,DetectorType=RmsAverage,Bandwidth=[1000000],OffsetFrequency=[0],Function=[BandPower],FilterType=[IBW],FilterAlpha=[0.22],OccupiedBandwidthPercent=[0.99],XdBBandwidth=[-3.01],DoNoiseCorrection=False,DoSpurSuppression=False,MeasurementMethod=HardwareFFT,IncludePowerSpectrum=False,TriggerDelay=0,TriggerLevel=1.2,TriggerSlope=Positive,TriggerSource=Free,TriggerTimeout=1"

I A.14.00

n
i
t
i
a
l

S
/
W

R
e
v
i
s
i
o
n

Configure Fast Power Measurement (Remote Command Only)

The configure command begins hardware setup and returns immediately, with no acquisition made. This can be used in parallel with other hardware operations to effectively hide the hardware setup time.

Mode	All
Remote Command	:CALCulate:FPOWER:POWER[1,2,...,999]:CONFigure
Example	:CALC:FPOW:POW1:CONF
Notes	Option FP2 is required.
Initial S/W Revision	A.14.00

Initiate Fast Power Measurement (Remote Command Only)

The INITiate command begins an acquisition and returns immediately. The results of the measurement can be retrieved using FETCh.

Mode	All
Remote Command	:CALCulate:FPOWER:POWER[1,2,...,999]:INITiate
Example	:CALC:FPOW:POW1:INIT
Notes	Option FP2 is required.
Initial S/W Revision	A.14.00

Fetch Fast Power Measurement (Remote Command Only)

The FETCh command query is used to retrieve the results of an acquisition initiated by the INIT command. The returned results are in ASCII string format. The string begins and ends with quotation marks.

Mode	All
Remote Command	:CALCulate:FPOWER:POWER[1,2,...,999]:FETCh?
Example	:CALC:FPOW:POW1:FETC?
Notes	Option FP2 is required. Returns m comma-separated ASCII values, where m corresponds to the number of bandwidths defined. 1. Declared function return in the 1st specified channel 2. Declared function return in the 2nd specified channel ... m. Declared function return in the last specified channel The INIT and FETC? command sequence performs the same functionality of a single CALC:FPOW:POW[n]? query. Units of the returned values are dependent on the Function parameter for each channel.
Initial S/W Revision	A.14.00

Execute Fast Power Measurement (Remote Command Only)

This command query is used as shorthand for an INIT command immediately followed by a FETC? command. The returned results are in ASCII string format. The string begins and ends with quotation marks.

Mode	All
Remote Command	:CALCulate:FPOWER:POWER[1,2,...,999]?
Example	:CALC:FPOW:POW1?

Notes	Option FP2 is required. See notes for Fast Power Fetch for return format.
Initial S/W Revision	A.14.00

Binary Read Fast Power Measurement (Remote Command Only)

This command query is used as shorthand for an INIT command immediately followed by a FETC? command. The returned results are in a binary format.

Mode	All
Remote Command	:CALCulate:FPOWER:POWER[1,2,...,999]:READ? :CALCulate:FPOWER:POWER[1,2,...,999]:READ1?
Example	:CALC:FPOW:POW1:READ? :CALC:FPOW:POW1:READ1?
Notes	Option FP2 is required. Returns m 4 byte floating point binary values (Little-Endian), where m corresponds to the number of bandwidths defined.
Initial S/W Revision	A.14.00

Diagnostic Binary Read Fast Power Measurement (Remote Command Only)

This command query is used as shorthand for an INIT command immediately followed by a FETC? command. The returned results are in a binary format. This command is used primarily for diagnostic purposes to test for ADC overloads and to visibly inspect the spectrum.

Mode	All
Remote Command	:CALCulate:FPOWER:POWER[1,2,...,999]:READ2?
Example	:CALC:FPOW:POW1:READ2?
Notes	Option FP2 is required. Note: Spectrum data is only returned if the IncludePowerSpectrum parameter is set to True. If IncludePowerSpectrum is False, the number of spectrum points will be zero (0). Units of the returned values are dependent on the Function parameter per channel (e.g. dBm for BandPower, Hz for PeakFrequency). Returns binary data (Little-Endian) that contains information on m amount of channels, along with ADC over range and full spectrum data. The following is the binary format of the response. Bandwidth Return Value 1. Number of channels specified, m [4 byte int] 2. Declared function result for the 1st specified channel [4 byte float]

	3. Declared function result for the 2nd specified channel [4 byte float]
	...
	(m + 1). Declared function result for the last (mth) specified channel [4 byte float]
	ADC Over Range
	1. ADC over-range occurred (1: true, 0: false) [2 byte short]
	Spectrum Data
	1. Number of points in the spectrum data, k [4 byte int]
	2. Start frequency of spectrum data (Hz) [8 byte double]
	3. Step frequency of spectrum data (Hz) [8 byte double]
	4. FFT bin at 1st point (dBm) [4 byte float]
	5. FFT bin at 2nd point (dBm) [4 byte float]
	...
	(k + 3). FFT bin at last (kth) point (dBm) [4 byte float]

Initial S/W Revision	A.14.00
-------------------------	---------

Format Data: Numeric Data (Remote Command Only)

This command specifies the format of the trace data input and output. It specifies the formats used for trace data during data transfer across any remote port. It affects only the data format for setting and querying trace data for the :TRACe[:DATA], TRACe[:DATA]?, :CALCulate:DATA[n]? and FETCh:SANalyzer [n]? commands and queries.

Remote Command	:FORMat [:TRACe] [:DATA] ASCii INTeger, 32 REAL, 32 REAL, 64 :FORMat [:TRACe] [:DATA] ?
Notes	The query response is: ASCii: ASC,8 REAL,32: REAL,32 REAL,64: REAL,64 INTeger,32: INT,32 When the numeric data format is REAL or ASCii, data is output in the current Y Axis unit. When the data format is INTeger, data is output in units of m dBm (.001 dBm). The INT,32 format returns binary 32-bit integer values in internal units (m dBm), in a definite length block.
Dependencies	Sending a data format spec with an invalid number (for example, INT,48) generates no error. The analyzer simply uses the default (8 for ASCii, 32 for INTeger, 32 for REAL). Sending data to the analyzer which does not conform to the current FORMat specified, results in an error. Sending ASCII data when a definite block is expected generates message -161 "Invalid Block Data" and sending a definite block when ASCII data is expected generates message -121 "Invalid Character in Number".
Preset	ASCii
Backwards Compatibility	Note that the INT,32 format is only applicable to the command, TRACe:DATA. This preserves

Notes	backwards compatibility for the Swept SA measurement. For all other commands/queries which honor FORMat:DATA, if INT,32 is sent the analyzer will behave as though it were set to REAL,32.
Initial S/W Revision	Prior to A.02.00

The specs for each output type follow:

ASCIi - Amplitude values are in ASCII, in the current Y Axis Unit, one ASCII character per digit, values separated by commas, each value in the form:

SX.YYYYYEsZZ

Where:

S = sign (+ or -)

X = one digit to left of decimal point

Y = 5 digits to right of decimal point

E = E, exponent header

s = sign of exponent (+ or -)

ZZ = two digit exponent

REAL,32 - Binary 32-bit real values in the current Y Axis Unit, in a definite length block.

REAL,64 - Binary 64-bit real values in the current Y Axis Unit, in a definite length block.

Format Data: Byte Order (Remote Command Only)

This command selects the binary data byte order for data transfer and other queries. It controls whether binary data is transferred in normal or swapped mode. This command affects only the byte order for setting and querying trace data for the :TRACe[:DATA], TRACe[:DATA]? , :CALCulate:DATA[n]? and FETCh:SANalyzer[n]? commands and queries.

By definition any command that says it uses FORMat:DATA uses any format supported by FORMat:DATA.

The NORMAl order is a byte sequence that begins with the most significant byte (MSB) first, and ends with the least significant byte (LSB) last in the sequence: 1|2|3|4. SWAPped order is when the byte sequence begins with the LSB first, and ends with the MSB last in the sequence: 4|3|2|1.

Remote Command	:FORMat:BORDER NORMAl SWAPped :FORMat:BORDER?
Preset	NORMAl
Initial S/W Revision	Prior to A.02.00

Meas Setup

Displays the setup menu for the currently selected measurement.

Key Path	Front-panel key
Initial S/W Revision	Prior to A.02.00

Avg/Hold Num

Toggles averaging On or Off in addition to enabling you to set the number of measurement averages used to calculate the measurement result. The average is displayed at the end of each sweep. After the specified number of average counts, the average mode (termination control) setting determines the average action.

In the remote mode, use the Average State command to turn averaging on or off.

Key Path	Meas Setup
Mode	SA, WCDMA, C2K, WIMAX OFDMA, TD-SCDMA, 1xEVDO, DTMB (CTTB), DVB-T/H, ISDB-T, CMMB, LTE, LTE-TDD, Digital Cable TV, WLAN, MSR, LTEAFDD, LTEATDD
Remote Command	[:SENSe]:SEMask:AVERage:COUNT <integer> [:SENSe]:SEMask:AVERage:COUNT? [:SENSe]:SEMask:AVERage[:STATe] ON OFF 1 0 [:SENSe]:SEMask:AVERage[:STATe]?
Example	SEM:AVER:COUN 100 SEM:AVER:COUN? SEM:AVER ON SEM:AVER?
Notes	You must be in the mode that includes SEM measurement to use this command. Use :INSTrument:SElect to set the mode.
Preset	10 OFF
State Saved	Saved in instrument state.
Min	1
Max	10000
Initial S/W Revision	Prior to A.02.00
Modified at S/W Revision	A.02.00, A.03.00

Meas Type

Accesses a menu that enables you to select one of the following measurement reference types:

- Total Pwr Ref – Sets the reference to the total carrier power and the measured data is shown in dBc and dBm.
- PSD Ref – Sets the reference to the mean power spectral density of the carrier and the measured data is shown in dB and dBm/Hz.
- Spectrum Peak Ref – Sets the reference to the spectrum peak power of the carrier and the measured data is shown in dB and dBm.

Key Path	Meas Setup
Mode	SA, WCDMA, C2K, WIMAX OFDMA, TD-SCDMA, 1xEVDO, DTMB (CTTB), DVB-T/H, ISDB-T, CMMB, LTE, LTE-TDD, Digital Cable TV, WLAN, MSR, LTEAFDD, LTEATDD
Remote Command	[:SENSe] :SEMask:TYPE PSDRef TPRef SPRef [:SENSe] :SEMask:TYPE?
Example	SEM:TYPE PSDR SEM:TYPE?
Notes	You must be in the mode that includes SEM measurement to use this command. Use :INSTrument:SElect to set the mode.
Preset	SA, , WCDMA, , C2K, , TD-SCDMA, , 1xEVDO, , DTMB (CTTB), , DVB-T/H, , ISDB-T, , CMMB, , LTE, , LTE-TDD, , Digital Cable TV, , MSR, , LTEAFDD, , LTEATDD: TPRef WIMAX OFDMA, WLAN: SPRef
State Saved	Saved in instrument state.
Range	Total Pwr Ref PSD Ref Spectrum Peak Ref
Initial S/W Revision	Prior to A.02.00
Modified at S/W Revision	A.02.00, A.03.00

Ref Channel

Accesses a menu that enables you to set up the measurement parameters used to calculate the power in the reference channel.

Key Path	Meas Setup
Initial S/W Revision	Prior to A.02.00

Integ BW

Specifies the integration bandwidth used to calculate the power in the reference channel.

Key Path	Meas Setup, Ref Channel
Mode	SA, WCDMA, C2K, WIMAX OFDMA, TD-SCDMA, 1xEVDO, DTMB (CTTB), DVB-T/H, ISDB-T, CMMB, LTE, LTE-TDD, Digital Cable TV, WLAN
Remote Command	[:SENSe] :SEMask:BANDwidth[1] 2:INTEgration <bandwidth> [:SENSe] :SEMask:BANDwidth[1] 2:INTEgration?

Example	SEM:BAND:INT 10 MHz SEM:BAND:INT?
Notes	10% . 100% of Channel Span Parameter Value Bandwidth sub op code, 1 is for BTS, 2 for MS. Default is BTS. You must be in the mode that includes SEM measurement to use this command. Use :INSTrument:SElect to set the mode.
Dependencies	For MSR and LTE-Advanced FDD/TDD mode, this key is blank.
Couplings	Cannot be higher than the channel Span. If lower than 1/10 of channel Span, then the channel Span is reduced to be 10 times the Integ BW.
Preset	SA: 3.84 MHz WCDMA: 3.84 MHz 3.84 MHz C2K: 1.23 MHz 1.23 MHz WIMAX OFDMA: 10 MHz 10 MHz TD-SCDMA: 1.28 MHz 1.28 MHz 1xEVDO: 1.23MHz DTMB (CTTB): 7.56MHz DVB-T/H: 7.61MHz ISDB-T: 5.6MHz CMMB: 7.512MHz LTE: 4.515MHz 4.5MHz LTETDD: 4.515MHz 4.5MHz Digital Cable TV: 6.9MHz WLAN: if Radio Std is 802.11a/g(OFDM/DSSS-OFDM)/802.11n(20 MHz)/ 802.11ac (20 MHz): 18 MHz if Radio Std is 802.11b/g(DSSS/CCK/PBCC): 22 MHz if Radio Std is 802.11n(40MHz)/ 802.11ac (40 MHz): 38 MHz if Radio Std is 802.11ac (80 MHz): 78 MHz if Radio Std is 802.11ac (160 MHz): 158 MHz if Radio Std is 802.11ac (80 MHz + 80 MHz): 78 MHz
State Saved	Saved in instrument state.
Min	1 kHz
Max	645 MHz
Initial S/W Revision	Prior to A.02.00
Modified at S/W Revision	A.02.00, A.03.00

Span

Specifies the span used to calculate the power in the reference channel.

Key Path	Meas Setup, Ref Channel
-----------------	-------------------------

Mode	SA, WCDMA, C2K, WIMAX OFDMA, TD-SCDMA, 1xEVDO, DTMB (CTTB), DVB-T/H, ISDB-T, LTE, LTETDD, CMMB, Digital Cable TV, WLAN
Remote Command	[:SENSe] :SEMAsk:FREQuency [1] 2:SPAN <freq> [:SENSe] :SEMAsk:FREQuency [1] 2:SPAN?
Example	SEM:FREQ:SPAN 3MHz SEM:FREQ:SPAN?
Notes	Frequency sub op code, 1 is for BTS, 2 for MS. Default is BTS. You must be in the mode that includes SEM measurement to use this command. Use :INSTrument:SElect to set the mode.
Dependencies	For MSR and LTE-Advanced FDD/TDD mode, this key is blank.
Couplings	Range 1 kHz to 50 MHz (although restricted by Integ BW). If you set the channel Span lower than channel Integ BW, they will both track each other. As you increase the channel Span, the Integ BW will also increase if it is less than 1/10 of the channel Span. For WLAN 802.11ac (80 + 80 MHz), the channel span is coupled with the difference between the center frequencies of the two carriers. When the difference is either less than 80 MHz or greater than 565 MHz, a “setting conflict” error message is displayed. Chan Span = Carrier Spacing + Chan IntegBW;
Preset	SA: 5.0 MHz WCDMA: 5.0 MHz 5.0 MHz C2K: 1.25 MHz 1.25 MHz WIMAX OFDMA: 10 MHz 10 MHz TD-SCDMA: 1.6 MHz 1.6 MHz 1xEVDO: 1.25 MHz DTMB (CTTB): 10 MHz DVB-T/H: 10 MHz ISDB-T: 8 MHz CMMB: 10 MHz LTE: 5 MHz LTETDD: 5 MHz Digital Cable TV: 10 MHz WLAN: if Radio Std is 802.11a/g(OFDM/DSSS-OFDM)/802.11n(20 MHz)/ 802.11ac (20 MHz): 18 MHz if Radio Std is 802.11b/g(DSSS/CCK/PBCC): 22 MHz if Radio Std is 802.11n(40MHz)/ 802.11ac (40 MHz): 38 MHz if Radio Std is 802.11ac (80 MHz): 78 MHz if Radio Std is 802.11ac (160 MHz): 158 MHz if Radio Std is 802.11ac (80 MHz + 80 MHz): 240 MHz
State Saved	Saved in instrument state.
Min	1 kHz
Max	645 MHz

Initial S/W Revision	Prior to A.02.00
Modified at S/W Revision	A.02.00, A.03.00

Sweep Time

Sets the sweep time used to calculate the power in the reference channel. Sweep Time can be set manually or put in auto mode.

Key Path	Meas Setup, Ref Channel
Mode	SA, WCDMA, C2K, WIMAX OFDMA, TD-SCDMA, 1xEVDO, DTMB (CTTB), DVB-T/H, ISDB-T, CMMB, LTE, LTEFDD, Digital Cable TV, WLAN, MSR, LTEAFDD, LTEATDD
Remote Command	<pre>[:SENSe] :SEMAsk:SWEep [1] 2 :TIME <time> [:SENSe] :SEMAsk:SWEep [1] 2 :TIME? [:SENSe] :SEMAsk:SWEep [1] 2 :TIME:AUTO OFF 0 ON 1 [:SENSe] :SEMAsk:SWEep [1] 2 :TIME:AUTO?</pre>
Example	<pre>SEM:SWE:TIME 9ms SEM:SWE:TIME? SEM:SWE:TIME:AUTO OFF SEM:SWE:TIME:AUTO?</pre>
Notes	<p>Sub op code, 1 is for BTS, 2 for MS. Default is BTS.</p> <p>You must be in the mode that includes SEM measurement to use this command. Use :INSTrument:SELEct to set the mode.</p>
Couplings	<p>When the time is set manually, Auto is set to OFF.</p> <p>Value is coupled with Channel Detector selection, Channel Resolution BW, Channel Video BW if the state is Auto.</p> <p>When set to Auto, the Sweep Time is automatically calculated</p>
Preset	<p>Automatically calculated</p> <p>ON</p>
State Saved	Saved in instrument state.
Min	1 ms
Max	4000 s
Initial S/W Revision	Prior to A.02.00
Modified at S/W Revision	A.02.00, A.03.00

Power Ref (for the modes except MSR and LTE-Advanced FDD/TDD)

Sets the power reference in the carrier that will be used to compute the relative values for the offsets.

Key Path	Meas Setup, Ref Channel
Initial S/W Revision	Prior to A.02.00

Total Power

Sets the power in the carrier (ref channel) that is used to compute the relative power values for the offsets. When the state is set to auto, this value is set to the measured carrier reference power. When set to manual, the result takes on the last measured value, or can be manually entered.

For WLAN 802.11ac (80 MHz + 80 MHz), the higher of the power readouts of the two carriers is used for computing the relative power values for the offset.

Key Path	Meas Setup, Ref Channel, Power Ref
Mode	SA, WCDMA, C2K, WIMAX OFDMA, TD-SCDMA, 1xEVDO, DTMB (CTTB), DVB-T/H, ISDB-T, CMMB, LTE, LTE-TDD, Digital Cable TV, WLAN, MSR, LTEAFDD, LTEATDD
Remote Command	[:SENSe]:SEMAsk:CARRier[:POWer] <real> [:SENSe]:SEMAsk:CARRier[:POWer]? [:SENSe]:SEMAsk:CARRier:AUTO[:STATe] OFF ON 1 0 [:SENSe]:SEMAsk:CARRier:AUTO[:STATe]?
Example	SEM:CARR 100dBm SEM:CARR? SEM:CARR:AUTO OFF SEM:CARR:AUTO?
Notes	The min and max values given are for Meas Type = Total Pwr Ref. You must be in the mode that includes SEM measurement to use this command. Use :INSTRument:SELEct to set the mode.. This BAF SCPI command is available in all the Meas Type case. This BAF SCPI command is not available in MSR and LTE-Advanced FDD/TDD mode.
Dependencies	This "Total Power Ref" parameter is coupled with the "Meas Type" parameter. The softkey is active when Meas Type is set to Total Power Ref. Otherwise, it is grayed out.
Preset	Measured carrier reference power
State Saved	Saved in instrument state.
Min	-200 dBm
Max	200 dBm
Initial S/W Revision	Prior to A.02.00
Modified at S/W Revision	A.02.00, A.03.00

PSD

Sets the power spectral density in the carrier that is used to compute the relative power spectral density values for the offsets when Meas Type is set to PSD Ref. When the state is set to auto, this will be set to

the measured carrier power spectral density.

For WLAN 802.11ac (80 MHz + 80 MHz), the higher of the power density readouts of the two carriers is used for computing the relative PSD values for the offset.

Key Path	Meas Setup, Ref Chan, Power Ref
Mode	SA, WCDMA, C2K , WIMAX OFDMA, TD-SCDMA, 1xEVDO, DTMB (CTTB), DVB-T/H, ISDB-T, CMMB, LTE, LTEFDD, Digital Cable TV, WLAN, MSR, LTEAFDD, LTEATDD
Remote Command	[:SENSe] :SEMAsk:CARRier:CPsD <real> [:SENSe] :SEMAsk:CARRier:CPsD?
Example	SEM:CARR:CPsD -80 SEM:CARR:CPsD?
Notes	Although the default value is defined, the value is recalculated by the measurement result just after completing the measurement. Carrier sub op code. 1 for BTS, 2 for MS. Default is BTS. You must be in the mode that includes SEM measurement to use this command. Use :INSTrument:SElect to set the mode.
Dependencies	See Couplings
Couplings	This "PSD" parameter is coupled with the "Meas Type" parameter. The key will be active if the Meas Type is set to PSD. Otherwise, it is grayed out.
Preset	Measured carrier PSD reference power
State Saved	Saved in instrument state.
Min	-200
Max	200
Initial S/W Revision	Prior to A.02.00
Modified at S/W Revision	A.02.00, A.03.00

Spectrum Peak

Sets the spectrum peak power in the carrier that is used to compute the relative power spectral density values for the offsets when Meas Type is set to Spectrum Peak. When the state is set to auto, this is set to the measured carrier spectrum peak power. When set to manual, the result takes on the last measured value, or can be manually entered

Key Path	Meas Setup, Ref Channel, Power Ref
Mode	SA, WCDMA, C2K , WIMAX OFDMA, TD-SCDMA, 1xEVDO, DTMB (CTTB), DVB-T/H, ISDB-T, CMMB, LTE, LTEFDD, Digital Cable TV, WLAN
Remote Command	[:SENSe] :SEMAsk:CARRier:PEAK[:POWer] <real> [:SENSe] :SEMAsk:CARRier:PEAK[:POWer] ?
Example	SEM:CARR:PEAK -80 SEM:CARR:PEAK:POWER?
Notes	Although the default value is defined, the value is recalculated by the measurement result just after completing the measurement.

	Carrier sub op code. 1 for BTS, 2 for MS. Default is BTS. You must be in the mode that includes SEM measurement to use this command. Use :INSTrument:SElect to set the mode.
Dependencies	See Couplings
Couplings	This "Spectrum Peak Ref" parameter is coupled with the "Meas Type" parameter. This softkey is active when the "Meas Type" is set to "Spectrum Peak Ref". Otherwise, grayout.
Preset	Measured carrier Spectrum Peak reference power
State Saved	Saved in instrument state.
Min	-200
Max	200
Initial S/W Revision	Prior to A.02.00
Modified at S/W Revision	A.02.00, A.03.00

Res BW

Sets the resolution bandwidth used to calculate the power in the reference channel. The Channel Resolution BW can be set manually or put in to auto mode.

MSR Auto RBW:

In the MSR resolution bandwidth is predefined for each radio format. When carriers are configured with multiple radio formats, the narrowest RBW is selected.

LTE	1.4 MHz	13
	3 MHz	27
	5 MHz	47
	10 MHz	91
	15 MHz	150
	20 MHz	180
W-CDMA		75
GSM		30

In LTE-Advanced FDD/TDD, the resolution bandwidth is predefined based on the corresponding bandwidth of the single LTE carrier, which is listed above. When ResBW mode is Auto, the narrowest RBW is selected.

Key Path	Meas Setup, Ref Channel
Mode	SA, WCDMA, C2K, WIMAX OFDMA, TD-SCDMA, 1xEVDO, DTMB (CTTB), DVB-T/H, ISDB-T, CMMB, LTE, LTE-TDD, Digital Cable TV, WLAN, MSR, LTEAFDD, LTEATDD
Remote Command	[:SENSe] :SEMAsk :BANDwidth [1] 2 [:RESolution] <bandwidth> [:SENSe] :SEMAsk :BANDwidth [1] 2 [:RESolution] ? [:SENSe] :SEMAsk :BANDwidth [1] 2 [:RESolution] :AUTO OFF ON 1 0

	<code>[:SENSe] :SEMAsk :BANDwidth [1] 2 [:RESolution] :AUTO?</code>
Example	SEM:BAND 100 kHz SEM:BAND? SEM:BAND:AUTO ON SEM:BAND:AUTO?
Notes	Bandwidth sub op code, 1 is for BTS, 2 for MS. Default is BTS. You must be in the mode that includes SEM measurement to use this command. Use :INSTrument:SElect to set the mode.
Couplings	When Res BW is set manually, Channel Resolution BW Mode is set to Manual. Value is coupled with Channel Detector selection, Channel Sweep Time, Channel Video BW. When set to Auto, the resolution bandwidth is automatically calculated.
Preset	SA: 100 kHz WCDMA: 75 kHz C2K: 24 kHz WIMAX OFDMA: 100 kHz TD-SCDMA: 30 kHz 1xEVDO: 30.0 KHz DTMB (CTTB): 3.9 kHz DVB-T/H: 3.9 kHz ISDB-T: 10 kHz CMMB: 3.9 kHz LTE, , LTETDD, , MSR, , LTEAFDD, , LTEATDD:Auto (47 kHz) Digital Cable TV: 3.9 kHz WLAN: 100 kHz ON
State Saved	Saved in instrument state.
Min	1 Hz
Max	8 MHz
Backwards Compatibility SCPI	<code>[:SENSe] :SEMAsk :BWIDth [1] 2 [:RESolution]</code>
Initial S/W Revision	Prior to A.02.00
Modified at S/W Revision	A.02.00, A.03.00

Video BW

Sets the video bandwidth used to calculate the power in the reference channel. The Channel Video BW can be set manually or put in to auto mode.

Key Path	Meas Setup, Ref Channel
Mode	SA, WCDMA, C2K, WIMAX OFDMA, TD-SCDMA, 1xEVDO, DTMB (CTTB), DVB-T/H, ISDB-T, CMMB,

	LTE, LTE-TDD, Digital Cable TV, WLAN, MSR, LTEAFDD, LTEATDD
Remote Command	<pre>[:SENSe] :SEMask:BAWidth[1] 2:VIDeo <bandwidth> [:SENSe] :SEMask:BAWidth[1] 2:VIDeo? [:SENSe] :SEMask:BAWidth[1] 2:VIDeo:AUTO OFF ON 1 0 [:SENSe] :SEMask:BAWidth[1] 2:VIDeo:AUTO?</pre>
Example	<pre>SEM:BAW:VID 100 kHz SEM:BAW:VID? SEM:BAW:VID:AUTO ON SEM:BAW:VID:AUTO?</pre>
Notes	<p>Bandwidth sub op code, 1 is for BTS, 2 for MS. Default is BTS.</p> <p>You must be in the mode that includes SEM measurement to use this command. Use :INSTrument:SElect to set the mode.</p>
Couplings	<p>When Video BW is set manually, Channel Video BW Mode is set to MANual</p> <p>Value is coupled with Channel Detector selection, Channel Sweep Time, Channel Resolution BW.</p> <p>When set to Auto, the video bandwidth is automatically calculated.</p>
Preset	<pre>SA: 100 kHz WCDMA: 75 kHz C2K: 24 kHz WIMAX OFDMA: 30 kHz TD-SCDMA: 300 kHz 1xEVDO: 300.0 kHz DTMB (CTTB): 39 kHz DVB-T/H: 39 kHz ISDB-T: 1 kHz CMMB: 39 kHz LTE, MSR, LTEAFDD, LTEATDD: Auto LTE-TDD: Auto Digital Cable TV: 39 kHz WLAN: Auto ON</pre>
State Saved	Saved in instrument state.
Min	1 Hz
Max	50 MHz
Backwards Compatibility SCPI	[:SENSe] :SEMask:BWIDth[1] 2:VIDeo
Initial S/W Revision	Prior to A.02.00
Modified at S/W Revision	A.02.00, A.03.00

VBW/RBW

Sets the Video BW/Resolution BW Ratio to calculate the Channel Resolution BW and Channel Video BW. The VBW/RBW Ratio can be set manually or put in to auto mode.

Key Path	Meas Setup, Ref Channel
Mode	SA, WCDMA, C2K, WIMAX OFDMA, TD-SCDMA mode, 1xEVDO, DTMB (CTTB), DVB-T/H, ISDB-T, CMMB, LTE, LTETDD, Digital Cable TV, WLAN, MSR, LTEAFDD, LTEATDD
Remote Command	[:SENSe]:SEMAsk:BAWdwidth[1] 2:VIDeo:RATio <real> [:SENSe]:SEMAsk:BAWdwidth[1] 2:VIDeo:RATio [:SENSe]:SEMAsk:BAWdwidth[1] 2:VIDeo:RATio:AUTO OFF ON 1 0 [:SENSe]:SEMAsk:BAWdwidth[1] 2:VIDeo:RATio:AUTO?
Example	SEM:BAWd:VID:RAT 0.1 SEM:BAWd:VID:RAT? SEM:BAWd:VID:RAT:AUTO ON SEM:BAWd:VID:RAT:AUTO?
Notes	Bandwidth sub op code, 1 is for BTS, 2 for MS. Default is BTS. You must be in the mode that includes SEM measurement to use this command. Use :INSTRument:SELEct to set the mode.
Couplings	When Video BW/Res BW is set manually, Channel VBW/RBW Ratio Mode is set to Manual When set to Auto, the VBW/RBW Ratio is automatically calculated.
Preset	SA, WCDMA, C2K: 1.0 WIMAX OFDMA: 0.3 TD-SCDMA: 10 1xEVDO: 10.0 DTMB (CTTB): 10 DVB-T/H: 10 ISDB-T: 0.1 CMMB: 10 LTE, MSR: Auto LTEAFDD,LTEATDD:Auto LTETDD: Auto Digital Cable TV: 10 WLAN: Auto ON
State Saved	Saved in instrument state.
Min	0.00001
Max	3000000
Backwards Compatibility SCPI	[:SENSe]:SEMAsk:BWIDth[1] 2:VIDeo:RATio
Initial S/W Revision	Prior to A.02.00
Modified at S/W Revision	A.02.00, A.03.00

Offset/Limits

Accesses a menu that enables you to set up the measurement parameters for offset pairs. For example, you can assign the start and stop frequencies, select the resolution bandwidth, and set the sweep time. When in the MSR and LTE-Advanced FDD/TDD mode, the softkey label changes to Outer Offset/Limits.

Key Path	Meas Setup
Initial S/W Revision	Prior to A.02.00
Modified at S/W Revision	A.14.00

Select Offset

Selects the offset (upper and lower) and displays the memory selection menu that enables you to store a set of parameter values for the offset, such as Start Freq, Stop Freq, Sweep Time, Res BW, Meas BW, Abs Start, and Abs Stop. Only one selection at a time is shown on this menu key label.

Key Path	Meas Setup, Offset/Limits
Mode	SA, WCDMA, C2K, WIMAX OFDMA, TD-SCDMA, 1xEVDO, DTMB (CTTB), DVB-T/H, ISDB-T, CMMB, LTE, LTE-TDD, Digital Cable TV, WLAN, MSR, LTEAFDD, LTEATDD
Preset	A
Range	MSR, LTEATDD, LTEAFDD, WLAN: A B C D E F G H I J K L Other modes without option N9060A-7FP: A B C D E F Other modes with option N9060A-7FP: A B C D E F G H I J K L
Initial S/W Revision	Prior to A.02.00
Modified at S/W Revision	A.02.00, A.03.00, A.10.00, A.11.00, A.14.00

Start Freq

Specifies the start frequency for the currently selected offset. Also enables you to toggle that offset between On and Off.

Missing values are not permitted; that is, if you want to change values 2 and 6, you must send all values up to 6. Subsequent values will remain as they were. The query for this parameter always returns 12 values.

Key Path	Meas Setup, Offset/Limits
Mode	SA, WCDMA, C2K, WIMAX OFDMA, TD-SCDMA, 1xEVDO, DTMB (CTTB), DVB-T/H, ISDB-T, CMMB, LTE, LTE-TDD, Digital Cable TV, WLAN, MSR, LTEAFDD, LTEATDD
Remote Command	[:SENSe] :SEMAsk:OFFSet [1] 2 [:OUTer] :LIST:FREQuency:START <freq>, ... [:SENSe] :SEMAsk:OFFSet [1] 2 [:OUTer] :LIST:FREQuency:START? [:SENSe] :SEMAsk:OFFSet [1] 2 [:OUTer] :LIST:STATe ON OFF 1 0, ... [:SENSe] :SEMAsk:OFFSet [1] 2 [:OUTer] :LIST:STATe?

Example	<pre>SEM:OFFS2:LIST:FREQ:STAR 2.515 MHz , 2.715 MHz , 3.515 MHz , 4.00 MHz , 8.00 MHz , 12.50 MHz SEM:OFFS2:LIST:FREQ:STAR? SEM:OFFS:LIST:STAT ON , ON , ON , OFF , OFF , OFF SEM:OFFS:LIST:STAT?</pre>
Notes	<p>Comma separated list of values. OFFSet1 is for BTS, 2 for MS. Default is BTS. You must be in the mode that includes SEM measurement to use this command. Use :INSTrument:SElect to set the mode.</p>
Couplings	<p>Coupled to Stop Freq. When the start freq goes above the stop freq, the stop freq is automatically adjusted to the start freq plus 100 Hz. If the current mode is DVB-T/H, this value will be modified automatically according to the limit type and the output power of the transmitter which is less or more than 25 W. If the current mode is ISDB-T, this value will be modified automatically according to the limit type.</p>
Preset	<p>For modes (except MSR, , LTEAFDD, , LTEATDD and WLAN) without option N9060A-7FP, , the preset value is as follows. SA: 2.515 MHz, , 2.715 MHz, , 3.515 MHz, , 4.00 MHz, , 8.00 MHz, , 12.50 MHz WCDMA: 2.515 MHz, , 2.715 MHz, , 3.515 MHz, , 4.000 MHz, , 8.000 MHz, , 12.50 MHz 2.515MHz, , 4.000 MHz, , 7.500 MHz, , 8.500 MHz, , 12.5 MHz, , 15 MHz C2K: 750.0 kHz, , 780.0 kHz, , 1.980 MHz, , 3.25 MHz, , 7.0 MHz, , 7.0 MHz 885 kHz, , 1.980 MHz, , 2.250 MHz, , 8.0 MHz, , 12.0 MHz, , 12.0 MHz WIMAX OFDMA: 4.75 MHz, 5.45 MHz, 9.75 MHz, 14.75 MHz, 19.75 MHz, 24.75 MHz 4.75 MHz, 5.45 MHz, 9.75 MHz, 14.75 MHz, 19.75 MHz, 24.75 MHz TD-SCDMA: 81 5kHz, 1015 kHz, 1815 kHz, 2.3 MHz, , , 2.3 MHz, , 2.3 MHz 815 kHz, 1.8 MHz, 2.9 MHz, , 2.9 MHz, 2.9 MHz, , 2.9 MHz 1xEVDO: 750.0 kHz, , 780.0 kHz, , 1.98 MHz, , 3.25 MHz, , 7 MHz, , 7 MHz 885.0 kHz, , 1.98 MHz, , 1.98 MHz, , , 1.98 MHz, , 1.98 MHz, , 1.98 MHz DTMB (CTTB): 3.8 MHz, , 4.2 MHz, , 6 MHz, , 6 MHz, , 6 MHz, 6 MHz 6MHz, , 6MHz, , 6MHz, , 6MHz, , 6MHz, 6MHz DVB-T/H: 3.81 MHz, , 4.2 MHz, , 6 MHz, , 6 MHz, , 6 MHz, , 6 MHz 6MHz, , 6MHz, , 6MHz, , 6MHz, , 6MHz ISDB-T: 2.79 MHz, , 2.86 MHz, , 3.0 MHz, , 4.36 MHz, , 6 MHz, , 6 MHz 6MHz, , 6MHz, , 6MHz, , 6MHz, , 6MHz CMMB: 3.8 MHz, , 4.2 MHz, , 8.0 MHz, , 6 MHz, , 6 MHz, , 6 MHz 6MHz, , 6MHz, , 6MHz, , 6MHz, , 6MHz LTE, LTETDD: 50 kHz, , 5.05 MHz, , 10.5 MHz, , 15.00 MHz, , 30 MHz, , 40 MHz 15.00 kHz, 1.5 MHz, 5.5 MHz, 6.5 MHz, 10 MHz, 20MHz Digital Cable TV: 3.8 MHz, , 4.2 MHz, , 6 MHz, , 6 MHz, , 6 MHz, , 6 MHz 6MHz, , 6MHz, , 6MHz, , 6MHz, , 6MHz When option N9060A-7FP is installed in these modes, , the preset value of Offset G ~ L is the same as the Offset F value. -----</p>

WLAN:

if Radio Std is 802.11a/g(OFDM/DSSS-OFDM)/802.11n(20MHz): 9 MHz , 11 MHz , 20 MHz , 30 MHz , 50 MHz , 216 MHz , 216 MHz , 216 MHz , 216 MHz , 216 MHz , 216 MHz , 216 MHz

if Radio Std is 802.11b/g(DSSS/CCK/PBCC): 11 MHz , 22 MHz , 50 MHz , 70 MHz , 90 MHz , 100 MHz , 100 MHz , 100 MHz , 100 MHz , 100 MHz , 100 MHz , 100 MHz

if Radio Std is 802.11n(20MHz): 9 MHz , 11 MHz , 20 MHz , 30 MHz , 50 MHz , 100 MHz , 100 MHz , 100 MHz , 100 MHz , 100 MHz , 100 MHz

if Radio Std is 802.11n(40MHz): 19 MHz , 21 MHz , 40 MHz , 60 MHz , 100 MHz , 200 MHz , 200 MHz , 200 MHz , 200 MHz , 200 MHz , 200 MHz

if Radio Std is 802.11ac(20MHz): 9 MHz , 11 MHz , 20 MHz , 30 MHz , 30 MHz , 30 MHz , 30 MHz , 30 MHz , 30 MHz , 30 MHz , 30 MHz

if Radio Std is 802.11ac(40MHz): 19 MHz , 21 MHz , 40 MHz , 60 MHz , 60 MHz , 60 MHz , 60 MHz , 60 MHz , 60 MHz , 60 MHz , 60 MHz

if Radio Std is 802.11ac(80MHz): 39 MHz , 41 MHz , 80 MHz , 120 MHz , 120 MHz , 120 MHz , 120 MHz , 120 MHz , 120 MHz , 120 MHz , 120 MHz

if Radio Std is 802.11ac(160MHz): 79 MHz , 81 MHz , 160 MHz , 240 MHz , 240 MHz , 240 MHz , 240 MHz , 240 MHz , 240 MHz , 240 MHz , 240 MHz

if Radio Std is 802.11ac(80 MHz + 80MHz): 0 MHz , 40 MHz , 79 MHz , 159 MHz , 161 MHz , 200 MHz , 240 MHz , 240 MHz , 240 MHz , 240 MHz , 240 MHz , 240 MHz

MSR:15 kHz , 215kHz , 1.015MHz , 1.5MHz , 10.5MHz , 15.00MHz , 30MHz , 30MHz , 30MHz , 30MHz , 30MHz | 15kHz , 215kHz , 1.015MHz , 1.5MHz , 10.5MHz , 15.00MHz , 30MHz , 30MHz , 30MHz , 30MHz , 30MHz , 30MHz

LTEAFDD , LTEATDD: 50 kHz , 5.05 MHz , 10.5 MHz , 15.00 MHz , 30 MHz , 40 MHz , 40 MHz , 40 MHz , 40 MHz , 40 MHz | 15.00 kHz , 1.5 MHz , 5.5 MHz , 6.5 MHz , 10 MHz , 20MHz , 20MHz , 20MHz , 20MHz , 20MHz , 20MHz , 20MHz

For modes (except MSR , LTEAFDD , LTEATDD and WLAN) without option N9060A-7FP , the preset value is as follows.

SA: ON, ON, ON, ON, ON, OFF

WCDMA: ON, , ON, , ON, , ON, , OFF|ON, , ON, , ON, , OFF, , OFF

C2K: ON, , ON, , ON, , OFF, , OFF, , OFF|ON, , ON, , OFF, , OFF, , OFF, , OFF

WIMAX OFDMA: ON, , ON, , ON, , OFF, , OFF, , OFF|ON, , ON, , ON, , OFF, , OFF, , OFF

TD-SCDMA: ON, , ON, , ON, , ON, , OFF, , OFF|ON, , ON, , ON, , OFF, , OFF, , OFF

1xEVDO: ON, , ON, , ON, , OFF, , OFF, , OFF|ON, , ON, , OFF, , OFF, , OFF, , OFF

DTMB (CTTB) , DVB-T/H , CMMB , Digital Cable TV: ON, , ON, , ON, , OFF, , OFF, , OFF

ISDB-T: ON, ON, ON, ON, OFF, OFF

LTE , LTEATDD: ON, , ON, , ON, , OFF, , OFF, , OFF|ON, ON, ON, ON, OFF, OFF

When option N9060A-7FP is installed in these modes , the preset value of Offset G ~ L is the same as the Offset F value.

WLAN:

if Radio Std is 802.11b/g(DSSS/CCK/PBCC): ON, , ON, , OFF, , OFF, , OFF, , OFF, , OFF, , OFF, , OFF, , OFF, , OFF

if Radio Std is 802.11a/g(OFDM/DSSS-OFDM)/802.11n(20MHz/40MHz): ON, , ON, , ON, , ON, , OFF, , OFF, , OFF, , OFF, , OFF, , OFF, , OFF, , OFF

	if Radio Std is 802.11ac (20 MHz/ 40 MHz/ 80 MHz/ 160 MHz): ON, , ON, , ON, , ON, , OFF, , OFF, , OFF, , OFF, , OFF, , OFF, , OFF
	if Radio Std is 802.11ac (80 MHz + 80 MHz): ON, , ON, , ON, , ON, , ON, , ON, , ON, , OFF, , OFF, , OFF, , OFF, , OFF
	MSR:ON, , ON, , ON, , ON, , ON, , OFF, , OFF, , OFF, , OFF, , OFF, , OFF, , OFF ON, , ON, , ON, , ON, , ON, , OFF, , OFF, , OFF, , OFF, , OFF, , OFF, , OFF
	LTEAFDD, , LTEATDD: ON, , ON, , ON, , OFF, , OFF, , OFF, , OFF, , OFF, , OFF, , OFF, , OFF, , OFF ON, , ON, , ON, , ON, , OFF, , OFF, , OFF, , OFF, , OFF, , OFF, , OFF, , OFF
State Saved	Saved in instrument state.
Min	0 Hz
Max	499.9999 MHz
Initial S/W Revision	Prior to A.02.00
Modified at S/W Revision	A.02.00, A.03.00, A.10.00, A.11.00, A.14.00

Stop Freq

Specifies the stop frequency for the currently selected offset.

Missing values are not permitted; that is, if you want to change values 2 and 6, you must send all values up to 6. Subsequent values will remain as they were. The query for this parameter always returns 12 values.

Key Path	Meas Setup, Offset/Limits
Mode	SA, WCDMA, C2K, WIMAX OFDMA, TD-SCDMA, 1xEVDO, DTMB (CTTB), DVB-T/H, ISDB-T, CMMB, LTE, LTE-TDD, Digital Cable TV, WLAN, MSR, LTEAFDD, LTEATDD
Remote Command	[:SENSe] :SEMAsk:OFFSet [1] 2 [:OUTer] :LIST:FREQuency:STOP <freq>, ... [:SENSe] :SEMAsk:OFFSet [1] 2 [:OUTer] :LIST:FREQuency:STOP?
Example	SEM:OFFS:LIST:FREQ:STOP 2.715 MHz, , 3.515 MHz, , 4.00 MHz, , 8.00 MHz, , 12.50 MHz, , 15.0 MHz SEM:OFFS:LIST:FREQ:STOP?
Notes	Comma separated list of values. OFFSet1 is for BTS, 2 for MS. Default is BTS. You must be in the mode that includes SEM measurement to use this command. Use :INSTrument:SElect to set the mode.
Couplings	Coupled to Start Freq. When the stop freq goes below the start freq, the start freq is automatically adjusted to the stop freq minus 100 Hz. If the current mode is DVB-T/H, this value will be modified automatically according to the limit type and the output power of the transmitter which is less or more than 25 W. If the current mode is ISDB-T, this value will be modified automatically according to the limit type.
Preset	For modes (except MSR, , LTEAFDD, , LTEATDD and WLAN) without option N9060A-7FP, , the preset value is as follows. SA: 2.715 MHz, , 3.515 MHz, , 4.00 MHz, , 8.00 MHz, , 12.50 MHz, , 15.0 MHz

WCDMA: 2.715 MHz, 3.515 MHz, 4.000 MHz, 8.000 MHz, 12.50 MHz, 15.0 MHz | 3.485 MHz, 7.500 MHz, 8.500 MHz, 12.00 MHz, 15.00 MHz, 18.0 MHz

C2K: 780.0 kHz, 1.980 MHz, 4.0 MHz, 4.0 MHz, 12.0 MHz, 12.0 MHz | 1.980 MHz, 4.0 MHz, 4.0 MHz, 11.5 MHz, 14.5 MHz, 14.5 MHz

WIMAX OFDMA: 5.45 MHz, 9.75 MHz, 14.75 MHz, 19.75 MHz, 24.75 MHz, 29.75 MHz | 5.45 MHz, 9.75 MHz, 14.75 MHz, 19.75 MHz, 24.75 MHz, 29.75 MHz

TD-SCDMA:

1015 kHz, 1815 kHz, 2.3 MHz, 4 MHz, 4 MHz, 4 MHz | 1.8 MHz, 2385 kHz, 3.5 MHz, 3.5 MHz, 3.5 MHz, 3.5 MHz

1xEVDO: 780.0 kHz, 1.98 MHz, 4.0 MHz, 4.0 MHz, 12 MHz, 12 MHz | 1.98 MHz, 4.0 MHz, 4.0 MHz, 4.0 MHz, 4.0 MHz, 4.0 MHz

DTMB (CTTB): 4.2 MHz, 6 MHz, 12 MHz, 12 MHz, 12 MHz, 12 MHz | 12 MHz, 12 MHz, 12 MHz, 12 MHz, 12 MHz, 12 MHz

DVB-T/H: 4.2 MHz, 6 MHz, 12 MHz, 12 MHz, 12 MHz, 12 MHz | 12 MHz, 12 MHz, 12 MHz, 12 MHz, 12 MHz, 12 MHz

ISDB-T: 2.86 MHz, 3.0 MHz, 4.36 MHz, 15.0 MHz, 15.0 MHz, 15.0 MHz | 15 MHz, 15 MHz, 15 MHz, 15 MHz, 15 MHz, 15 MHz

CMMB: 4.2 MHz, 8.0 MHz, 12.0 MHz, 12.0 MHz, 12.0 MHz, 12.0 MHz | 12 MHz, 12 MHz, 12 MHz, 12 MHz, 12 MHz, 12 MHz

LTE, LTE TDD: 5.05 MHz, 10.05 MHz, 15 MHz, 30 MHz, 40 MHz, 50 MHz | 985.0 kHz, 4.50 MHz, 5.5001 MHz, 9.50 MHz, 20 MHz, 40 MHz

Digital Cable TV: 4.2 MHz, 6.0 MHz, 12.0 MHz, 12.0 MHz, 12.0 MHz, 12.0 MHz, 12 MHz, 12 MHz, 12 MHz, 12 MHz, 12 MHz, 12 MHz

When option N9060A-7FP is installed in these modes, the preset value of Offset G ~ L is the same as the Offset F value.

WLAN:

if Radio Std is 802.11a/g(OFDM/DSSS-OFDM)/802.11n(20MHz): 11 MHz, 20 MHz, 30 MHz, 50 MHz, 100 MHz, 250 MHz, 250 MHz, 250 MHz, 250 MHz, 250 MHz, 250 MHz, 250 MHz

if Radio Std is 802.11b/g(DSSS/CCK/PBCC): 22 MHz, 50 MHz, 70 MHz, 90 MHz, 100 MHz, 120 MHz, 120 MHz, 120 MHz, 120 MHz, 120 MHz, 120 MHz, 120 MHz

if Radio Std is 802.11n(20MHz): 11 MHz, 20 MHz, 30 MHz, 50 MHz, 100 MHz, 200 MHz, 200 MHz, 200 MHz, 200 MHz, 200 MHz, 200 MHz, 200 MHz

if Radio Std is 802.11n(40MHz): 21 MHz, 40 MHz, 60 MHz, 100 MHz, 200 MHz, 300 MHz, 300 MHz, 300 MHz, 300 MHz, 300 MHz, 300 MHz, 300 MHz

if Radio Std is 802.11ac(20MHz): 11 MHz, 20 MHz, 30 MHz, 50 MHz, 50 MHz, 50 MHz, 50 MHz, 50 MHz, 50 MHz, 50 MHz, 50 MHz, 50 MHz

if Radio Std is 802.11ac(40MHz): 21 MHz, 40 MHz, 60 MHz, 100 MHz, 100 MHz, 100 MHz, 100 MHz, 100 MHz, 100 MHz, 100 MHz, 100 MHz, 100 MHz

if Radio Std is 802.11ac(80MHz): 41 MHz, 80 MHz, 120 MHz, 200 MHz, 200 MHz, 200 MHz, 200 MHz, 200 MHz, 200 MHz, 200 MHz, 200 MHz, 200 MHz

if Radio Std is 802.11ac(160MHz): 81 MHz, 160 MHz, 240 MHz, 400 MHz, 400 MHz, 400 MHz, 400 MHz, 400 MHz, 400 MHz, 400 MHz, 400 MHz, 400 MHz

if Radio Std is 802.11ac(80 MHz + 80MHz): 40 MHz, 79 MHz, 81 MHz, 161 MHz, 200 MHz, 200 MHz, 200 MHz, 200 MHz, 200 MHz, 200 MHz, 200 MHz, 200 MHz

	240 MHz , 260 MHz , 260 MHz , 260 MHz , 260 MHz , 260 MHz , 260 MHz MSR: 215kHz , 1.015MHz , 1.5MHz , 10.5MHz , 50MHz , 50MHz , 50MHz , 50MHz , 50MHz , 50MHz , 50MHz , 50MHz LTEAFDD , LTEATDD: 5.05 MHz , 10.05 MHz , 15 MHz , 30 MHz , 40 MHz , 50 MHz , 50 MHz , 50 MHz , 50 MHz , 50 MHz 985.0 kHz , 4.50 MHz , 5.5001 MHz , 9.50 MHz , 20 MHz , 40 MHz , , 40 MHz , 40 MHz , 40 MHz , 40 MHz , 40 MHz , 40 MHz
State Saved	Saved in instrument state.
Min	100 Hz
Max	500 MHz
Initial S/W Revision	Prior to A.02.00
Modified at S/W Revision	A.02.00, A.03.00, A.10.00, A.11.00, A.14.00

Sweep Time

Specifies the sweep time for the currently selected offset and enables you to toggle the Sweep Time mode between Auto and Man.

Missing values are not permitted; that is, if you want to change values 2 and 6, you must send all values up to 6. Subsequent values will remain as they were. The query for this parameter always returns 12 values.

Key Path	Meas Setup, Offset/Limits
Mode	SA, WCDMA, C2K, WIMAX OFDMA, TD-SCDMA, 1xEVDO, DTMB (CTTB), DVB-T/H, ISDB-T, CMMB, LTE, LTE-TDD, Digital Cable TV, WLAN, MSR, LTEAFDD, LTEATDD
Remote Command	[:SENSE] :SEMAsk:OFFSet [1] 2 [:OUTer] :LIST:SWEep:TIME <time> , ... [:SENSE] :SEMAsk:OFFSet [1] 2 [:OUTer] :LIST:SWEep:TIME? [:SENSE] :SEMAsk:OFFSet [1] 2 [:OUTer] :LIST:SWEep:TIME:AUTO ON OFF 1 0 , ... [:SENSE] :SEMAsk:OFFSet [1] 2 [:OUTer] :LIST:SWEep:TIME:AUTO?
Example	SEM:OFFS2:LIST:SWE:TIME 1.0 ms , 3.4 ms , 2.08 ms , 1.0 ms , 1.0 ms , 1.0 ms SEM:OFFS2:LIST:SWE:TIME? SEM:OFFS2:LIST:SWE:TIME:AUTO ON , ON , , ON , , OFF , , OFF SEM:OFFS2:LIST:SWE:TIME:AUTO?
Notes	Comma separated list of values. OFFSet1 is for BTS, 2 for MS. Default is BTS. You must be in the mode that includes SEM measurement to use this command. Use :INSTRument:SELEct to set the mode.
Couplings	When the sweep time is set manually, Sweep Time Mode is set to MANUAL. If the current mode is DVB-T/H, this value will be modified automatically according to the output power of the transmitter which is less or more than 25W. If the current mode is ISDB-T, this value will be modified automatically according to the limit type.
Preset	Automatically calculated

	Modes (except MSR, , LTEAFDD, , LTEATDD and WLAN) without option N9060A-7FP: ON, ON, ON, ON, ON, ON
	Modes (except MSR, , LTEAFDD, , LTEATDD and WLAN) with option N9060A-7FP: ON, ON, ON, ON, ON, ON, ON, ON, ON, ON, ON, ON, ON
	WLAN: ON, ON, ON, ON, ON, ON, ON, ON, ON, ON, , ON, ON, ON, ON
	MSR: ON,ON,ON,ON,ON,ON,ON,ON,ON,ON,ON,ON,ON
	LTEAFDD, , LTEATDD: ON, ON, ON, ON, ON, ON, ON, ON, ON, ON, ON, ON, ON ON, ON, ON, ON, ON, ON, ON, ON, ON, ON, ON, ON, ON
State Saved	Saved in instrument state.
Min	1 ms
Max	4000 s
Backwards Compatibility SCPI	[:SENSe] :SEMask:OFFSet [1] 2 :LIST:SWEEP [:TIME]
Initial S/W Revision	Prior to A.02.00
Modified at S/W Revision	A.02.00, A.03.00, A.10.00, A.11.00, A.14.00

Offset Side

Specifies which offset side to measure.

You can turn off (not use) specific offsets with [:SENSe]:SEMask:OFFSet[n][:OUTer]:LIST:STATe.

- **BOTH** – Both of the negative (lower) and positive (upper) sidebands
- **NEGative** – Negative (lower) sideband only
- **POSitive** – Positive (upper) sideband only

Missing values are not permitted; that is, if you want to change values 2 and 6, you must send all values up to 6. Subsequent values will remain as they were. The query for this parameter always returns 12 values.

The figure below shows the relation between the negative/positive offset side setups and the upper/lower results in the MSR and LTE-Advanced FDD/TDD.

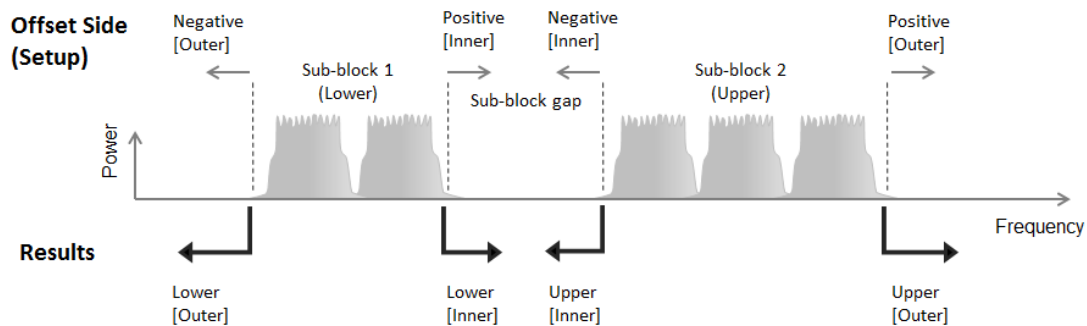

Key Path	Meas Setup, Offset/Limits
Mode	SA, WCDMA, C2K, WIMAX OFDMA, TD-SCDMA, 1xEVDO, DTMB (CTTB), DVB-T/H, ISDB-T, CMMB,

	LTE, LTETDD, Digital Cable TV, WLAN, MSR, LTEAFDD, LTEATDD
Remote Command	[:SENSe] :SEMAsk:OFFSet [1] 2 [:OUTer] :LIST:SIDE BOTH NEGative POSitive, ... [:SENSe] :SEMAsk:OFFSet [1] 2 [:OUTer] :LIST:SIDE?
Example	SEM:OFFS:LIST:SIDE BOTH, , NEG, , NEG, , POS, , POS, , POS SEM:OFFS:LIST:SIDE?
Notes	Comma separated list of values. OFFSet1 is for BTS, 2 for MS. Default is BTS. You must be in the mode that includes SEM measurement to use this command. Use :INSTrument:SElect to set the mode.
Preset	Modes (except MSR, , LTEAFDD, , LTEATDD and WLAN) without option N9060A-7FP: BOTH, , BOTH, , BOTH, , BOTH, , BOTH Modes (except MSR, , LTEAFDD, , LTEATDD and WLAN) with option N9060A-7FP: BOTH, , BOTH, , BOTH, , BOTH, , BOTH, , BOTH, , BOTH, , BOTH, , BOTH, , BOTH, , BOTH MSR: BOTH, , BOTH, , BOTH, , BOTH, , BOTH, , BOTH, , BOTH, , BOTH, , BOTH, , BOTH, , BOTH LTEAFDD, LTEATDD: BOTH, , BOTH, , BOTH, , BOTH, , BOTH, , BOTH, , BOTH, , BOTH, , BOTH, , BOTH, , BOTH BOTH, , BOTH, , BOTH, , BOTH, , BOTH, , BOTH, , BOTH, , BOTH, , BOTH, , BOTH, , BOTH WLAN: BOTH, , BOTH, , BOTH, , BOTH, , BOTH, , BOTH, , BOTH, , BOTH, , BOTH, , BOTH, , BOTH, , BOTH
State Saved	Saved in instrument state.
Range	Neg Both Pos
Initial S/W Revision	Prior to A.02.00
Modified at S/W Revision	A.02.00, A.03.00, A.10.00, A.11.00, A.14.00

Res BW

Specifies which Resolution BW filter to use when measuring the currently selected offset.

Offset Res BW Mode allows the instrument to determine the optimum Resolution BW filter to use when measuring the currently selected offset.. When changing the Meas BW parameter, if the Res BW needs to be changed to adhere to the rule

$$(N \times \text{Res BW}) \leq (\text{Stop freq of the offset} - \text{Start freq of the offset}),$$

where N is the multiplier, this setting will automatically be changed to manual.

Missing values are not permitted; that is, if you want to change values 2 and 6, you must send all values up to 6. Subsequent values will remain as they were. The query for this parameter always returns 12 values.

Key Path	Meas Setup, Offset/Limits
Mode	SA, WCDMA, C2K, WIMAX OFDMA, TD-SCDMA, 1xEVDO mode, DTMB (CTTB), DVB-T/H, ISDB-T, CMMB, LTE, LTETDD, Digital Cable TV, WLAN, MSR, LTEAFDD, LTEATDD

Remote Command	<pre>[:SENSe] :SEMAsk:OFFSet [1] 2 [:OUTer] :LIST:BANDwidth [:RESolution] <bandwidth>, ... [:SENSe] :SEMAsk:OFFSet [1] 2 [:OUTer] :LIST:BANDwidth [:RESolution] ? [:SENSe] :SEMAsk:OFFSet [1] 2 [:OUTer] :LIST:BANDwidth [:RESolution] :AUTO OFF ON 1 0, ... [:SENSe] :SEMAsk:OFFSet [1] 2 [:OUTer] :LIST:BANDwidth [:RESolution] :AUTO?</pre>
Example	<pre>SEM:OFFS2:LIST:BAND 30.0 kHz , 30.0 kHz , 30.0 kHz , 1.00 MHz, 1.00 MHz , 1.00 MHz SEM:OFFS2:LIST:BAND? SEM:OFFS:LIST:BAND:AUTO 1,1,1,1,1 SEM:OFFS:LIST:BAND:AUTO?</pre>
Notes	<p>Comma separated list of values. OFFSet1 is for BTS, 2 for MS. Default is BTS. You must be in the mode that includes SEM measurement to use this command. Use :INSTrument:SElect to set the mode.</p>
Couplings	<p>Coupled to Start and Stop offset and Meas BW multiplier. This parameter must adhere to the rule (N x Res BW) <= (Stop freq of the offset - Start freq of the offset), where N is the multiplier. If the multiplier is changed, the Res BW will be changed to ensure this. When set manually, Res BW Coupling is set to manual. The resolution bandwidth is coupled to the offset width determined by the start frequency and stop frequency.</p>
Preset	<p>For modes (except MSR, LTEAFDD, LTEATDD and WLAN) without option N9060A-7FP, the preset value is as follows.</p> <pre>SA: 30.0 kHz , 30.0 kHz , 30.0 kHz , 1.00 MHz, 1.00 MHz , 1.00 MHz WCDMA: 30.00 kHz , 30.00 kHz , 30.00 kHz , 100.00 kHz , 1.000 MHz , 1.00 MHz 30.00 kHz , 1.000 MHz , 1.000 MHz , 1.000 MHz , 1.00 MHz C2K: 3.00 kHz , 30.00 kHz , 30.00 kHz , 6.2 kHz , 1.000 MHz , 1.00 MHz 30.00 kHz , 30.00 kHz , 6.2 kHz , 1.000 MHz , 1.000 MHz , 1.00 MHz WIMAX OFDMA: 100 KHz , 100 KHz , 100 KHz , 100 KHz , 100 KHz , 100 KHz 100 KHz , 100 KHz , 100 KHz , 100 KHz , 100 KHz TD-SCDMA: 30 kHz , 30 kHz , 30 kHz , 50 kHz , 1 MHz , 1 MHz 30 kHz , 30 kHz , 50 kHz , 1 MHz , 1 MHz , 1 MHz 1xEVDO: 30.00 kHz , 30.00 kHz , 30.00 kHz , 6.2 kHz , 1.000 MHz , 1.000 MHz 30.00 kHz , 30.00 kHz , 30.00 kHz , 30.00 kHz , 30.00 kHz DTMB (CTTB), , DVB-T/H, , CMMB, , Digital Cable TV: 3.9 kHz , 3.9 kHz , 3.9 kHz , 3.9 kHz , 3.9 kHz , 3.9 kHz 30.00 kHz , 1.000 MHz , 1.000 MHz , 1.000 MHz , 1.00 MHz ISDB-T: 10.0 kHz , 10.0 kHz , 10.0 kHz , 10.0 kHz , 10. kHz , 10.0 kHz 30.00 kHz , 1.000 MHz , 1.000 MHz , 1.000 MHz , 1.00 MHz LTE, , LTETDD: 51 kHz , 100 kHz , 1.0 MHz , 1.0 MHz, 1.0 MHz , 1.0 MHz 15.0 kHz , 510 kHz , 1.0 MHz, 1.0 MHz, 1.0 MHz, 1.0 MHz</pre> <p>When option N9060A-7FP is installed in these modes, the preset value of Offset G ~ L is the same as the Offset F value.</p> <p>-----</p> <pre>WLAN: 100 KHz , 100 KHz , 100 KHz , 100 KHz , 100 KHz , 100 KHz , 100 KHz , 100 KHz , 100 KHz , 100 KHz , 100 KHz , 100 KHz</pre>

	LTE, LTE-TDD, Digital Cable TV, WLAN
Remote Command	[:SENSe] :SEMask:OFFSet [1] 2 [:OUTer] :LIST:BANDwidth:IMULti <integer>, ... [:SENSe] :SEMask:OFFSet [1] 2 [:OUTer] :LIST:BANDwidth:IMULti?
Example	SEM:OFFS2:LIST:BAND:IMUL 1,1,1,1,1 SEM:OFFS2:LIST:BAND:IMUL?
Notes	Comma separated list of values. OFFSet1 is for BTS, 2 for MS. Default is BTS. You must be in the mode that includes SEM measurement to use this command. Use :INSTrument:SElect to set the mode.
Couplings	This parameter must adhere to the rule (N x Res BW) <= (Stop freq of the offset - Start freq of the offset), where N is the multiplier. If the Res Bw is changed, the multiplier will be changed to ensure this.
Preset	For modes (except MSR, , LTEAFDD, , LTEATDD and WLAN) without option N9060A-7FP, , the preset value is as follows. SA: 1, 1, 1, 1, 1, 1 WCDMA: 1, , 1, , 1, , 10, , 1, , 1 1, , 1, , 1, , 1, , 1 C2K: 10, 1, 1, 1, 1, 1 1, 1, 1, 1, 1, 1 WIMAX OFDMA, , 1xEVDO: 1, , 1, , 1, , 1, , 1 1, , 1, , 1, , 1, , 1 TD-SCDMA:1, , 1, , 1, , 20, , 1, , 1 1, , 1, , 20, , 1, , 1, , 1 DTMB (CTTB), , DVB-T/H, , ISDB-T, , CMMB, , Digital Cable TV: 1, , 1, , 1, , 1, , 1 1, , 1, , 1, , 1, , 1 LTE, , LTE-TDD: 2, , 1, , 1, , 1, , 1 2, , 2, , 1, , 1, , 1, 1 When option N9060A-7FP is installed in these modes, , the preset value of Offset G ~ L is the same as the Offset F value. ----- WLAN: 1, 1, 1, 1, 1, 1, 1, 1, 1, 1, 1, 1 MSR: 1, , 1, , 1, , 1, , 1, , 1, , 1, , 1, , 1, , 1 1, , 1, , 1, , 1, , 1, , 1, , 1, , 1, , 1, , 1 LTEAFDD, , LTEATDD: 2, , 1, , 1, , 1, , 1, , 1, , 1, , 1, , 1, , 1 2, , 2, , 1, , 1, , 1, , 1, , 1, , 1, , 1, , 1, , 1
State Saved	Saved in instrument state.
Min	1
Max	1000
Backwards Compatibility SCPI	[:SENSe] :SEMask:OFFSet [1] 2 :LIST:BWIDth:IMULti
Initial S/W Revision	Prior to A.02.00
Modified at S/W Revision	A.02.00, A.03.00, A.10.00, A.11.00, A.14.00

Video BW

Changes the analyzer post-detection filter.

Missing values are not permitted; that is, if you want to change values 2 and 6, you must send all values up to 6. Subsequent values will remain as they were. The query for this parameter always returns 12 values.

Key Path	Meas Setup, Offset/Limits
Mode	SA, WCDMA, C2K, WIMAXOFDMA, TD-SCDMA, 1xEVDO, DTMB (CTTB), DVB-T/H, ISDB-T, CMMB, LTE, LTE-TDD, Digital Cable TV, WLAN, MSR, LTEAFDD, LTEATDD
Remote Command	[:SENSe]:SEMAsk:OFFSet [1] 2[:OUTer]:LIST:BAWdwidth:VIDeo <freq>, ... [:SENSe]:SEMAsk:OFFSet [1] 2[:OUTer]:LIST:BAWdwidth:VIDeo? [:SENSe]:SEMAsk:OFFSet [1] 2[:OUTer]:LIST:BAWdwidth:VIDeo:AUTO OFF ON 0 1, ... [:SENSe]:SEMAsk:OFFSet [1] 2[:OUTer]:LIST:BAWdwidth:VIDeo:AUTO?
Example	SEM:OFFS2:LIST:BAW:VID 3.00 kHz, , 3.00 kHz, , 3.00 kHz, , 100.0 kHz, 100.0 kHz, , 100.0 kHz SEM:OFFS2:LIST:BAW:VID? SEM:OFFS2:LIST:BAW:VID:AUTO ON, , ON, , ON, , ON, , ON, , ON SEM:OFFS2:LIST:BAW:VID:AUTO?
Notes	Comma separated list of values. OFFSet1 is for BTS, 2 for MS. Default is BTS. You must be in the mode that includes SEM measurement to use this command. Use :INSTRument:SElect to set the mode.
Preset	ISDB-T: 1.0kHz, , 1.0kHz, , 1.0kHz, , 1.0kHz, , 1.0kHz, , 1.0kHz Other than ISDB-T: Automatically Calculated Modes (except MSR, , LTEAFDD, , LTEATDD, , WLAN, , ISDB-T) without option N9060A-7FP: ON, , ON, , ON, , ON, , ON ON, , ON, , ON, , ON, , ON Modes (except MSR, , LTEAFDD, , LTEATDD, , WLAN, , ISDB-T) with option N9060A-7FP:ON, , ON, , ON, , ON, , ON, , ON, , ON, , ON, , ON, , ON, , ON ON, , ON, , ON, , ON, , ON, , ON, , ON, , ON, , ON ----- MSR, , LTEAFDD, , LTEATDD: ON, , ON, , ON, , ON, , ON, , ON, , ON, , ON, , ON, , ON ON, , ON, , ON, , ON, , ON, , ON, , ON, , ON, , ON, , ON WLAN: ON, , ON, , ON, , ON, , ON, , ON, , ON, , ON, , ON, , ON, , ON ON, , ON, , ON, , ON, , ON, , ON, , ON, , ON, , ON, , ON ISDB-T: OFF, , OFF, , OFF, , OFF, , OFF, , OFF OFF, , OFF, , OFF, , OFF, , OFF, , OFF
State Saved	Saved in instrument state.
Min	1 Hz
Max	50 MHz
Backwards Compatibility SCPI	[:SENSe]:SEMAsk:OFFSet [1] 2:LIST:BAWIDth:VIDeo
Initial S/W Revision	Prior to A.02.00
Modified at S/W Revision	A.02.00, A.03.00, A.10.00, A.11.00, A.14.00

VBW/RBW

Selects the ratio between the video and resolution bandwidths.

	, OFF
State Saved	Saved in instrument state.
Min	0.00001
Max	3000000
Initial S/W Revision	Prior to A.02.00
Modified at S/W Revision	A.02.00, A.03.00, A.10.00, A.11.00, A.14.00

Limits

Accesses a menu that enables you to set the power limits for start and stop frequencies of the selected offsets.

Key Path	Meas Setup
Initial S/W Revision	Prior to A.02.00

Select Offset

Selects the offset (upper and lower) and displays the memory selection menu that enables you to store a set of parameter values for the offset, such as Start Freq, Stop Freq, Sweep Time, Res BW, Meas BW, Abs Start, and Abs Stop. Only one selection at a time is shown on this menu key label.

Key Path	Meas Setup, Offset/Limits
Mode	SA, WCDMA, C2K, WIMAX OFDMA, TD-SCDMA, 1xEVDO, DTMB (CTTB), DVB-T/H, ISDB-T, CMMB, LTE, LTE-TDD, Digital Cable TV, WLAN, MSR, LTEAFDD, LTEATDD
Preset	A
Range	MSR, LTEATDD, LTEAFDD, WLAN: A B C D E F G H I J K L Other modes without option N9060A-7FP: A B C D E F Other modes with option N9060A-7FP: A B C D E F G H I J K L
Initial S/W Revision	Prior to A.02.00
Modified at S/W Revision	A.02.00, A.03.00, A.10.00, A.11.00, A.14.00

Abs Start

Sets the absolute power level limit at the start frequency for the selected offset. The absolute power level limit ranges from -200 to +50 dBm.

The fail condition for each offset channel is set remotely by [:SENSe]:SEMAsk:OFFSet[n]
[:OUTer]:LIST:TEST.

You can turn off (not use) specific offset channels remotely with [:SENSe]:SEMAsk:OFFSet[n]
[:OUTer]:LIST:STATe.

The SCPI query returns values currently set to the absolute power test limits.

Missing values are not permitted; that is, if you want to change values 2 and 6, you must send all values up to 6. Subsequent values will remain as they were. The query for this parameter always returns 12 values.

Key Path	Meas Setup, Offset/Limit, Limits
Mode	SA, WCDMA, C2K, WIMAX OFDMA, TD-SCDMA, 1xEVDO, DTMB (CTTB), DVB-T/H, ISDB-T, CMMB, LTE, LTEFDD, Digital Cable TV, WLAN, MSR, LTEAFDD, LTEATDD
Remote Command	[:SENSe] :SEMAsk:OFFSet [1] 2 [:OUTer] :LIST:STARt:ABSolute <real>, ... [:SENSe] :SEMAsk:OFFSet [1] 2 [:OUTer] :LIST:STARt:ABSolute?
Example	SEM:OFFS2:LIST:STAR:ABS -12.50 dBm, , -12.50 dBm, , -24.50 dBm, , -11.50 dBm, , -11.50 dBm, , -11.50 dBm SEM:OFFS2:LIST:STAR:ABS?
Notes	Comma separated list of values. OFFSet1 is for BTS, 2 for MS. Default is BTS. You must be in the mode that includes SEM measurement to use this command. Use :INSTrument:SElect to set the mode.
Couplings	If the current mode is DVB-T/H, this value will be modified automatically according to the limit type and the output power of the transmitter which is less or more than 25W. If the current mode is ISDB-T, this value will be modified automatically according to the limit type.
Preset	For modes (except MSR, LTEAFDD, LTEATDD and WLAN) without option N9060A-7FP, the preset value is as follows. SA, , WIMAX OFDMA: -14.00 dBm, , -14.00 dBm, , -26.00 dBm, , -13.00 dBm, , -13.00 dBm, , -13.00 dBm WCDMA: -12.50 dBm, , -12.50 dBm, , -24.50 dBm, , -11.50 dBm, , -11.50 dBm, , -11.50 dBm -69.6 dBm, , -54.3 dBm, , -54.3 dBm, , -54.3 dBm, , -54.3 dBm, , -54.3 dBm C2K: -27.00 dBm, , -27.00 dBm, , -27.00 dBm, , -46.00 dBm, , -13.00 dBm, , -13.00 dBm -70.13 dBm, , -70.13 dBm, , -35.00 dBm, , -13.00 dBm, , -13.00 dBm, , -13.00 dBm TD-SCDMA: -28 dBm, , -28 dBm, , -36 dBm, , -21 dBm, , -21 dBm, , -21 dBm -71.3 dBm, , -71.3 dBm, , -56.07 dBm, , -56.07 dBm, , -56.07 dBm, , -56.07 dBm 1xEVDO: -27.0dBm, , -27.00 dBm, , -27.00 dBm, , -46.00 dBm, , -13.00 dBm, , -13.00 dBm -70.13 dBm, , -70.13 dBm, , -70.13 dBm, , -70.13 dBm, , -70.13 dBm, , -70.13 dBm DTMB (CTTB): -14.0 dBm, , -14.0 dBm, , -26.0 dBm, , -13.0 dBm, , -13.0 dBm, , -13.0 dBm -13.0 dBm, , -13.0 dBm, , -13.0 dBm, , -13.0 dBm, , -13.0 dBm, , -13.0 dBm DVB-T/H: 11.2 dBm, , -29 dBm, , -41 dBm, , -66 dBm, , -82 dBm, , -82 dBm -82 dBm, , -82 dBm, , -82 dBm, , -82 dBm, , -82 dBm ISDB-T, , CMMB, Digital Cable TV: 50.0 dBm, , 50.0 dBm, , 50.0 dBm, , 50.0 dBm, , 50.0 dBm, , 50.0 dBm 50.0 dBm, , 50.0 dBm, , 50.0 dBm, , 50.0 dBm, , 50.0 dBm, , 50.0 dBm LTE, , LTEFDD: -5.5 dBm, , -12.5 dBm, , -15.0 dBm, , -15.0 dBm, , -15.0 dBm, , -15.0 dBm -13.5 dBm, , -8.5 dBm, , -11.5 dBm, , -23.5 dBm, , -23.5 dBm, , -23.5 dBm When option N9060A-7FP is installed in these modes, the preset value of Offset G ~ L is the same as the Offset F value. ----- WLAN: if Radio Std is 802.11a/g(OFDM/DSSS-OFDM): 16.00 dBm, , -4.00 dBm, , -12.00 dBm, , -

Remote Command	<pre>[:SENSe] :SEMAsk:OFFSet [1] 2 [:OUTer] :LIST:STOP:ABSolute <real>, ... [:SENSe] :SEMAsk:OFFSet [1] 2 [:OUTer] :LIST:STOP:ABSolute? [:SENSe] :SEMAsk:OFFSet [1] 2 [:OUTer] :LIST:STOP:ABSolute:COUPle ON OFF 1 0, ... [:SENSe] :SEMAsk:OFFSet [1] 2 [:OUTer] :LIST:STOP:ABSolute:COUPle?</pre>
Example	<pre>SEM:OFFS:LIST:STOP:ABS -12.50 dBm, , -24.50 dBm, , -24.50 dBm, , -11.50 dBm, , -11.50 dBm, , -11.50 dBm SEM:OFFS1:LIST:STOP:ABS? SEM:OFFS:LIST:STOP:ABS:COUP ON, , OFF, , ON, , ON, , ON, , ON SEM:OFFS:LIST:STOP:ABS:COUP?</pre>
Notes	<p>Comma separated list of values. OFFSet1 is for BTS, 2 for MS. Default is BTS. You must be in the mode that includes SEM measurement to use this command. Use :INSTrument:SElect to set the mode.</p>
Couplings	<p>Coupled to Abs Start if "Auto" is selected, that is, the Stop value is equal to the Start value. If the current mode is DVB-T/H, this value will be modified automatically according to the limit type and the output power of the transmitter which is less or more than 25W. If the current mode is ISDB-T, this value will be modified automatically according to the limit type.</p>
Preset	<p>For modes (except MSR, LTEAFDD, , LTEATDD and WLAN) without option N9060A-7FP, , the preset value is as follows.</p> <pre>SA, , WIMAX OFDMA: -14.00 dBm, , -26.00 dBm, , -26.00 dBm, , -13.00 dBm, , -13.00 dBm, , - 13.00 dBm WCDMA: -12.50 dBm, , -24.50 dBm, , -24.50 dBm, , -11.50 dBm, , -11.50 dBm, , -11.50 dBm -69.6 dBm, , -54.3 dBm, , -54.3 dBm, , -54.3 dBm, , -54.3 dBm, , -54.3 dBm C2K: -27.00 dBm, , -27.00 dBm, , -27.00 dBm, , -46.00 dBm, , -13.00 dBm, , -13.00 dBm -70.13 dBm, , -70.13 dBm, , -35.00 dBm, , -13.00 dBm, , -13.00 dBm, , -13.00 dBm TD-SCDMA: -28 dBm, , -36 dBm, , -36 dBm, , -21 dBm, , -21 dBm, , -21 dBm -71.3 dBm, , -71.3 dBm, , -56.07 dBm, , -56.07 dBm, , -56.07 dBm, , -56.07 dBm 1xEVDO: -27dBm, , -27.00 dBm, , -27.00 dBm, , -46.00 dBm, , -13.00 dBm, , -13.00 dBm -70.13 dBm, , -70.13 dBm, , -70.13 dBm, , -70.13 dBm, , -70.13 dBm, , -70.13 dBm DTMB (CTTB): -14.0 dBm, , -26.0 dBm, , -26.0 dBm, , -13.0 dBm, , -13.0 dBm, , -13.0 dBm -13.0 dBm, , -13.0 dBm, , -13.0 dBm, , -13.0 dBm, , -13.0 dBm DVB-T/H: -29 dBm, , -41 dBm, , -66 dBm, , -82 dBm, , -82 dBm, , -82 dBm -82 dBm, , -82 dBm, , -82 dBm, , -82 dBm, , -82 dBm, , -82 dBm ISDB-TCMMB, , Digital Cable TV: 50.0 dBm, , 50.0 dBm, , 50.0 dBm, , 50.0 dBm, , 50.0 dBm 50.0 dBm, , 50.0 dBm, , 50.0 dBm, , 50.0 dBm, , 50.0 dBm, , 50.0 dBm LTE, , LTETDD: -12.5 dBm, , -12.5 dBm, , -15.0 dBm, , -15.0 dBm, , -15.0 dBm, , -15.0 dBm -13.5 dBm, , -8.5 dBm, , -11.5 dBm, , -23.5 dBm, , -23.5 dBm, , -23.5 dBm When option N9060A-7FP is installed in these modes, , the preset value of Offset G ~ L is the same as the Offset F value. ----- WLAN:</pre>

	0 dB, , 0 dB 0 dB, , 0 dB, , 0 dB, , 0 dB, , 0 dB, , 0 dB, , 0 dB, , 0 dB, , 0 dB, , 0 dB
State Saved	Saved in instrument state.
Min	-200 dB
Max	50 dB
Initial S/W Revision	Prior to A.02.00
Modified at S/W Revision	A.02.00, A.03.00, A.10.00, A.11.00, A.14.00

Rel Stop

Sets a relative power level limit at the stop frequency for the selected offset. The relative power level limit ranges from -200 to +50 dBc.

The fail condition is set remotely by [:SENSe]:SEMAsk:OFFSet[n][:OUTer]:LIST:TEST for each offset channel.

You can turn off (not use) specific offset channels remotely with [:SENSe]:SEMAsk:OFFSet[n][:OUTer]:LIST:STATe.

The SCPI query returns values currently set to the offset stop relative power limits.

Missing values are not permitted; that is, if you want to change values 2 and 6, you must send all values up to 6. Subsequent values will remain as they were. The query for this parameter always returns 12 values.

Key Path	Meas Setup, Offset/Limits, Limits
Mode	SA, WCDMA, C2K, WIMAX OFDMA, TD-SCDMA, 1xEVDO, DTMB (CTTB), DVB-T/H, ISDB-T, CMMB, LTE, LTE-TDD, Digital Cable TV, WLAN, MSR, LTEAFDD, LTEATDD
Remote Command	[:SENSe]:SEMAsk:OFFSet[1] 2[:OUTer]:LIST:STOP:RCARrier <rel_ampl>, ... [:SENSe]:SEMAsk:OFFSet[1] 2[:OUTer]:LIST:STOP:RCARrier? [:SENSe]:SEMAsk:OFFSet[1] 2[:OUTer]:LIST:STOP:RCARrier:COUple ON OFF 1 0, ... [:SENSe]:SEMAsk:OFFSet[1] 2[:OUTer]:LIST:STOP:RCARrier:COUple?
Example	SEM:OFFS:LIST:STOP:RCAR -30, , -30, , -30, , -30, , -30, , -30 SEM:OFFS:LIST:STOP:RCAR? SEM:OFFS:LIST:STOP:RCAR:COUP ON, , ON, , ON, , ON, , ON SEM:OFFS:LIST:STOP:RCAR:COUP?
Notes	Comma separated list of values. OFFSet1 is for BTS, 2 for MS. Default is BTS. You must be in the mode that includes SEM measurement to use this command. Use :INSTrument:SElect to set the mode.
Couplings	Coupled to Rel Start if "Auto" is selected, that is, Start is made the same as Stop. If the current mode is DVB-T/H, this value will be modified automatically according to the limit type and the output power of the transmitter which is less or more than 25W. If the current mode is ISDB-T, this value will be modified automatically according to the limit type.

If the current mode is WLAN and radio std is 802.11n, Rel Stop limits will be set to following values when frequency changed to above 5GHz:

-20.00 dB, -28.00 dB, -40.00 dB, -40.00 dB, -40.00 dB, -40.00 dB, -40.00 dB, -40.00 dB, -40.00 dB, -40.00 dB, -40.00 dB, -40.00 dB

Preset

For modes (except MSR, LTEAFDD, LTEATDD and WLAN) without option N9060A-7FP, the preset value is as follows.

SA: -30.00 dB, -30.00 dB, -30.00 dB, -30.00 dB, -30.00 dB, -30.00 dB

WCDMA: -30.00 dB, -30.00 dB, -30.00 dB, -30.00 dB, -30.00 dB, -30.00 dB|-48.28 dB, -37.50 dB, -47.50 dB, -47.50 dB, -47.50 dB, -47.50 dB

C2K: -45.00 dB, -45.00 dB, -55.00 dB, -55.00 dB, -55.00 dB, -55.00 dB|-42.00 dB, -54.00 dB, -54.00 dB, -54.00 dB, -54.00 dB, -54.00 dB

WIMAX OFDMA: -25 dB, -32 dB, -50 dB, -50 dB, -50 dB, -50 dB

TD-SCDMA: -54.00 dB, -62.00 dB, -62.00 dB, -47.00 dB, -47.00 dB, -47.00 dB|-49.00 dB, -58.945 dB, -44.00 dB, -44.00 dB, -44.00 dB, -44.00 dB

1xEVDO: -45dB, -45.00 dB, -55.00 dB, -55.00 dB, -55.00 dB, -55.00 dB|-42dB, -54.00 dB, -54.00 dB, -54.00 dB, -54.00 dB, -54.00 dB

DTMB (CTTB): -83 dB, -95 dB, -120 dB, -120 dB, -120 dB, -120 dB|-120 dB, -120 dB, -120 dB, -120 dB, -120 dB, -120 dB

DVB-T/H: -73 dB, -85 dB, -110 dB, -126 dB, -126 dB, -126 dB|-126 dB, -126 dB, -126 dB, -126 dB, -126 dB, -126 dB

ISDB-T: -47.4 dB, -54.4 dB, XXX, 50 dB, 50 dB, 50 dB|50 dB, 50 dB, 50 dB, 50 dB, 50 dB, 50 dB, 50 dB; XXX is coupled with the total power reference P, it is -57.4 dB when $P < 0.025$ W, -67.4 dB when $P = 0.25$ W, $-(73.4 + 10\log P)$ dB when 0.25 W $< P < 2.5$ W or 0.025 W $< P < 0.25$ W, -77.4 dB when $P > 2.5$ W.

CMMB: -72 dB, -84 dB, -90 dB, -90 dB, -90 dB, -90 dB|-90 dB, -90 dB, -90 dB, -90 dB, -90 dB, -90 dB

LTE, LTETDD: 0 dB, 0 dB, 0 dB, 0 dB, 0 dB, 0 dB

Digital Cable TV: 0 dB, 0 dB, 0 dB, 0 dB, 0 dB, 0 dB|0 dB, 0 dB, 0 dB, 0 dB, 0 dB, 0 dB

When option N9060A-7FP is installed in these modes, the preset value of Offset G ~ L is the same as the Offset F value.

WLAN:

if Radio Std is 802.11a/g(OFDM/DSSS-OFDM): -20.00 dB, -28.00 dB, -40.00 dB, -40.00 dB, -47.00 dB, -47.00 dB, -47.00 dB, -47.00 dB, -47.00 dB, -47.00 dB, -47.00 dB, -47.00 dB

if Radio Std is 802.11b/g(DSSS/CCK/PBCC): -30 dB, -50 dB, -50 dB, -50 dB, -50 dB, -50 dB, -50 dB, -50 dB, -50 dB, -50 dB, -50 dB, -50 dB

if Radio Std is 802.11n(20MHz/40MHz): -20.00 dB, -28.00 dB, -45.00 dB, -45.00 dB, -45.00 dB, -45.00 dB, -45.00 dB, -45.00 dB, -45.00 dB, -45.00 dB, -45.00 dB, -45.00 dB

if Radio Std is 802.11ac (20 MHz/ 40 MHz/ 80 MHz/ 160 MHz): -20.00 dB, -28.00 dB, -40.00 dB, -40.00 dB, -40.00 dB, -40.00 dB, -40.00 dB, -40.00 dB, -40.00 dB, -40.00 dB, -40.00 dB, -40.00 dB

if Radio Std is 802.11ac(80 MHz + 80MHz): -28.00 dB, -20.00 dB, 0 dB, -20.00 dB, -28.00

- OR checks against both limits, failing if either of the limits is broken.
- AND will only display a fail if both of the limits are broken.

The absolute or relative power limit value for each offset channel can be set remotely with [:SENSe]:SEMAsk:OFFSet[n][:OUTer]:LIST:ABSolute or [:SENSe]:SEMAsk:OFFSet[n][:OUTer]:LIST:RCARrier.

You can turn off (not use) specific offset channels remotely with [:SENSe]:SEMAsk:OFFSet[n][:OUTer]:LIST:STATe.

Missing values are not permitted; that is, if you want to change values 2 and 6, you must send all values up to 6. Subsequent values will remain as they were. The query for this parameter always returns 12 values.

Key Path	Meas Setup, Offset/Limits, Limits
Mode	SA, WCDMA, C2K, WIMAX OFDMA, TD-SCDMA, 1xEVDO, DTMB (CTTB), DVB-T/H, ISDB-T, CMMB, LTE, LTETDD, Digital Cable TV, WLAN, MSR, LTEAFDD, LTEATDD
Remote Command	[:SENSe]:SEMAsk:OFFSet[1] 2[:OUTer]:LIST:TEST ABSolute AND OR RELative, ... [:SENSe]:SEMAsk:OFFSet[1] 2[:OUTer]:LIST:TEST?
Example	SEM:OFFS:LIST:TEST ABS, , ABS, , ABS, , ABS, , ABS, , ABS SEM:OFFS:LIST:TEST?
Notes	Comma separated list of values. You must be in the mode that includes SEM measurement to use this command. Use :INSTrument:SElect to set the mode.
Couplings	None If the current mode is DVB-T/H, this value will be modified automatically according to the limit type and the output power of the transmitter which is less or more than 25W.
Preset	For modes (except MSR, LTEAFDD, LTEATDD and WLAN) without option N9060A-7FP, the preset value is as follows. SA: ABS, ABS, ABS, ABS, ABS, ABS WCDMA: ABS, , ABS, , ABS, , ABS, , ABS AND, , AND, , AND, , AND, , AND, , AND C2K: REL, , REL, , REL, , ABS, , REL, , REL AND, , AND, , ABS, , REL, , REL, , REL WIMAX OFDMA: REL, , REL, , REL, , REL, , REL REL, , REL, , REL, , REL, , REL, , REL TD-SCDMA: ABS, , ABS, , ABS, , ABS, , ABS AND, , AND, , AND, , AND, , AND, , AND 1xEVDO: REL, , REL, , REL, , ABS, , REL, , REL AND, , AND, , AND, , OR, , AND, , AND DTMB (CTTB), ISDB-T, CMMB: REL, , REL, , REL, , REL, , REL, , REL REL, , REL, , REL, , REL, , REL, , REL DVB-T/H: ABS, , ABS, , ABS, , ABS, , ABS, , ABS ABS, , ABS, , ABS, , ABS, , ABS, , ABS LTE, , LTETDD: ABS, , ABS, , ABS, , ABS, , ABS, , ABS Digital Cable TV: REL, , REL, , REL, , REL, , REL, , REL REL, , REL, , REL, , REL, , REL, , REL When option N9060A-7FP is installed in these modes, the preset value of Offset G ~ L is the same as the Offset F value. ----- WLAN:

10 Spectrum Emission Mask Measurement
Meas Setup

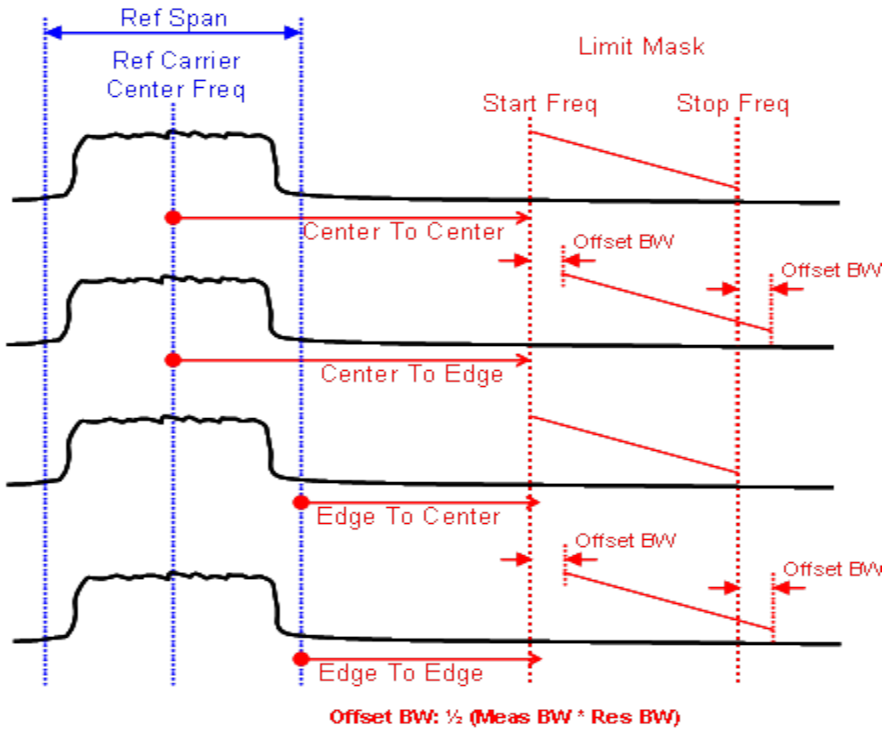
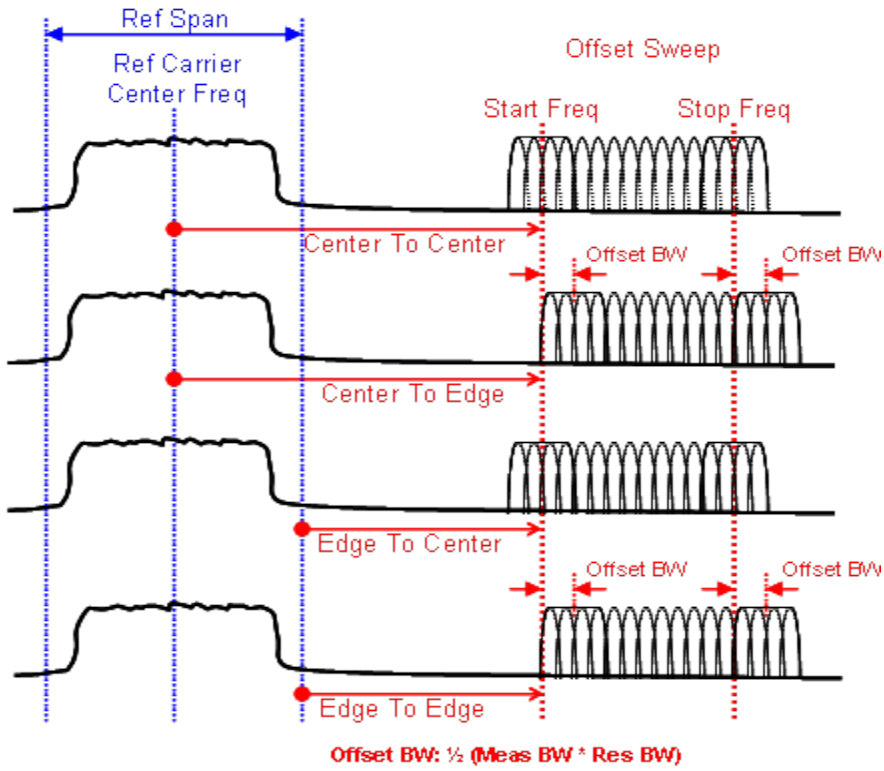

Key Path	Meas Setup, Offset/Limits
Mode	SA, WCDMA, C2K, WIMAX OFDMA, TD-SCDMA, 1xEVDO, DVB-T/H, DTMB (CTTB), ISDB-T, CMMB, LTE, LTE-TDD, Digital Cable TV, WLAN
Remote Command	<code>[:SENSe] :SEMAsk:OFFSet [1] 2 :TYPE CTOCenter CTOEdge ETOCenter ETOEdge</code> <code>[:SENSe] :SEMAsk:OFFSet [1] 2 :TYPE?</code>
Example	SEM:OFFS:TYPE ETOC SEM:OFFS:TYPE?
Notes	You must be in the mode that includes SEM measurements to use this command. Use <code>:INSTrument:SElect</code> to set the mode. For the MSR and LTE-Advanced FDD/TDD mode, see Offset Freq Define (Only for MSR and LTE-Advanced FDD/TDD) .
Preset	SA, , WCDMA, , WIMAX OFDMA, , TD-SCDMA, , DVB-T/H, , DTMB (CTTB), , ISDB-T, , CMMB, , Digital Cable TV: CTOC C2K: CTOE 1xEVDO: CTOE LTE: ETOC LTE-TDD: ETOC
State Saved	Saved in instrument state.
Range	Carrier Center To Meas BW Center Carrier Center To Meas BW Edge Carrier Edge To Meas BW Center Carrier Edge To Meas BW Edge
Initial S/W Revision	A.03.00

Meas Preset

Restores all the measurement parameters to their default values.

Key Path	Meas Setup
Mode	SA, WCDMA, C2K, WIMAX OFDMA, TD-SCDMA, 1xEVDO, DTMB (CTTB), DVB-T/H, ISDB-T, CMMB, LTE, LTE-TDD, Digital Cable TV, WLAN, MSR, LTEAFDD, LTEATDD
Remote Command	<code>:CONFigure:SEMAsk</code>
Example	CONF:SEM
Notes	You must be in the mode that includes SEM measurement to use this command. Use <code>:INSTrument:SElect</code> to set the mode.
Couplings	Selecting Meas Preset will restore all measurement parameters to their default values.
Initial S/W Revision	Prior to A.02.00
Modified at S/W Revision	A.02.00, A.03.00

10 Spectrum Emission Mask Measurement
Mode

Mode

See "[Mode](#)" on page 162

Mode Preset

Returns the active mode to a known state.

Mode Preset does the following for the currently active mode:

- Aborts the currently running measurement.
- Brings up the default menu for the mode, with no active function.
- Sets measurement Global settings to their preset values for the active mode only.
- Activates the default measurement.
- Brings up the default menu for the mode.
- Clears the input and output buffers.
- Sets Status Byte to 0.

Mode Preset does not:

- Cause a mode switch
- Affect mode persistent settings
- Affect system settings
- See "[How-To Preset](#)" on page 986 for more information.

Key Path	Front-panel key
Remote Command	:SYSTem:PRESet
Example	:SYST:PRES
Notes	*RST is preferred over :SYST:PRES for remote operation. *RST does a Mode Preset, as done by the :SYST:PRES command, and it sets the measurement mode to Single measurement rather than Continuous for optimal remote control throughput. Clears all pending OPC bits. The Status Byte is set to 0.
Couplings	A Mode Preset aborts the currently running measurement, activates the default measurement, and gets the mode to a consistent state with all of the default couplings set.
Backwards Compatibility Notes	In the X-Series, the legacy "Factory Preset" has been replaced with Mode Preset, which only presets the currently active mode, not the entire instrument. In the X-Series, the way to preset the entire instrument is by using System, Restore System Defaults All, which behaves essentially the same way as restore System Defaults does on ESA and PSA. There is also no "Preset Type" as there is on the PSA. There is a green Mode Preset front-panel key that does a Mode Preset and a white-with-green-letters User Preset front-panel key that does a User Preset. The old PRESet:TYPE command is ignored (without generating an error), and SYST:PRES without a parameter does a Mode Preset, which should cover most backward code compatibility issues. The settings and correction data under the Input/Output front-panel key (examples: Input Z Corr, Ext Amp Gain, etc.) are no longer part of any Mode, so they will not be preset by a Mode Preset. They are preset using Restore Input/Output Defaults, Restore System Defaults All. Note that because User Preset does a Recall State, and all of these settings are saved in State, they ARE recalled when using

	User Preset.
Initial S/W Revision	Prior to A.02.00

How-To Preset

The table below shows all possible presets, their corresponding SCPI commands and front-panel access (key paths). Instrument settings depend on the current measurement context. Some settings are local to the current measurement, some are global (common) across all the measurements in the current mode, and some are global to all the available modes. In a similar way, restoring the settings to their preset state can be done within the different contexts.

Auto Couple - is a measurement local key. It sets all Auto/Man parameter couplings in the measurement to Auto. Any Auto/Man selection that is local to other measurements in the mode will not be affected.

Meas Preset - is a measurement local key. Meas Preset resets all the variables local to the current measurement except the persistent ones.

Mode Preset - resets all the current mode's measurement local and measurement global variables except the persistent ones.

Restore Mode Defaults - resets ALL the Mode variables (and all the Meas global and Meas local variables), including the persistent ones.

Type Of Preset	SCPI Command	Front Panel Access
Auto Couple	:COUPle ALL	Auto Couple front-panel key
Meas Preset	:CONFigure:<Measurement>	Meas Setup Menu
Mode Preset	:SYSTem:PRESet	Mode Preset (green key)
Restore Mode Defaults	:INSTrument:DEFault	Mode Setup Menu
Restore All Mode Defaults	:SYSTem:DEFault MODes	System Menu; Restore System Default Menu
*RST	*RST	not possible (Mode Preset with Single)
Restore Input/Output Defaults	:SYSTem:DEFault INPUt	System Menu; Restore System Default Menu
Restore Power On Defaults	:SYSTem:DEFault PON	System Menu; Restore System Default Menu
Restore Alignment Defaults	:SYSTem:DEFault ALIGN	System Menu; Restore System Default Menu
Restore Miscellaneous Defaults	:SYSTem:DEFault MISC	System Menu; Restore System Default Menu
Restore All System Defaults	:SYSTem:DEFault [ALL] :SYSTem:PRESet:PERsistent	System Menu; Restore System Default Menu
User Preset	:SYSTem:PRESet:USER	User Preset Menu
User Preset All Modes	:SYSTem:PRESet:USER:ALL	User Preset Menu

Power On Mode Preset	:SYSTem:PON:TYPE MODE	System Menu
Power On User Preset	:SYSTem:PON:TYPE USER	System Menu
Power On Last State	:SYSTem:PON:TYPE LAST	System Menu

Mode Setup

See "[Mode Setup](#)" on page 181

Peak Search

There is no 'Peak Search' supported in Spectrum Emission Mask so this front-panel key displays a blank menu when pressed.

Key Path	Front-panel key
Initial S/W Revision	Prior to A.02.00

10 Spectrum Emission Mask Measurement
Print

Print

See "[Print](#) " on page 188

Quick Save

The Quick Save front-panel key repeats the most recent save that was performed from the Save menu, with the following exceptions:

- Register saves are not remembered as Saves for the purpose of the Quick Save function
- If the current measurement does not support the last non-register save that was performed, an informational message is generated, “File type not supported for this measurement”

Quick Save repeats the last type of qualified save (that is, a save qualified by the above criteria) in the last save directory by creating a unique filename using the Auto File Naming algorithm described below.

If Quick Save is pressed after startup and before any qualified Save has been performed, the Quick Save function performs a Screen Image save using the current settings for Screen Image saves (current theme, current directory), which then becomes the “last save” for the purpose of subsequent Quick Saves.

The Auto File Naming feature automatically generates a file name for use when saving a file. The filename consists of a prefix and suffix separated by a dot, as is standard for the Windows® file system. A default prefix exists for each of the available file types:

Type	Default Prefix	Menu
State	State_	(Save/Recall)
Trace + State	State_	(Save/Recall)
Screen	Screen_	(Save/Recall)
Amplitude Corrections	Ampcor_	(Import/Export)
Traces	Trace_	(Import/Export)
Limit Lines	LLine_	(Import/Export)
Measurement Result	MeasR_	(Import/Export)
Capture Buffer	CapBuf_	(Import/Export)

A four digit number is appended to the prefix to create a unique file name. The numbering sequence starts at 0000 within each Mode for each file type and updates incrementally to 9999, then wraps to 0000 again. It remembers where it was through a Mode Preset and when leaving and returning to the Mode. It is reset by Restore Misc Defaults and Restore System Defaults and subsequent running of the instrument application. So, for example, the first auto file name generated for State files is State_0000.state. The next is State_0001, and so forth.

One of the key features of Auto File Name is that we guarantee that the Auto File Name will never conflict with an existing file. The algorithm looks for the next available number. If it gets to 9999, then it looks for holes. If it find no holes, that is no more numbers are available, it gives an error.

For example, if when we get to State_0010.state there is already a State_0010.state file in the current directory, it advances the counter to State_0011.state to ensure that no conflict will exist (and then it verifies that State_0011.state also does not exist in the current directory and advances again if it does, and so forth).

If you enter a file name for a given file type, then the prefix becomes the filename you entered instead of the default prefix, followed by an underscore. The last four letters (the suffix) are the 4-digit number.

For example, if you save a measurement results file as “fred.csv”, then the next auto file name chosen for a measurement results save will be fred_0000.csv.

NOTE Although 0000 is used in the example above, the number that is used is actually the current number in the Meas Results sequence, that is, the number that would have been used if you had not entered your own file name.

NOTE If the filename you entered ends with _dddd, where d=any number, making it look just like an auto file name, then the next auto file name picks up where you left off with the suffix being dddd + 1.

Key Path	Front-panel key
Notes	No remote command for this key specifically.
Initial S/W Revision	Prior to A.02.00

Recall

The Recall menu lets you choose what you want to recall, and where you want to recall it from. Among the types of files you can recall are **States and Traces**. In addition, an Import (Data) option lets you recall a number of data types stored in CSV files (as used by Excel and other spreadsheet programs).

NOTE

In products that run multiple instances of the X-Series Application, all instances share the same register and file location where you want to recall from.

The default paths for Recall are data type dependent and are the same as for the Save key.

Key Path	Front-panel key
Notes	<p>No remote command for this key specifically, but the :MMEM:LOAD command is available for specific file types. An example is :MMEM:LOAD:STATE <filename>.</p> <p>If you try to recall a State file for a mode that is not licensed or not available in the instrument, an error message will occur and the state will not change.</p>
Backwards Compatibility Notes	<p>In legacy analyzers, it was possible to load a state without affecting the trace data, limit lines or correction data. Similarly (since User Preset is actually loading a state), it was possible to do a User Preset without affecting the trace data, limit lines or correction data.</p> <p>In the X-Series, “state” always includes all of this data; so whenever state is loaded, all of the traces, limit lines and corrections are affected. Although this differs from previous behavior, it is desirable behavior, and should not cause adverse issues for users.</p>
Backwards Compatibility Notes	<p>Recall for the X-Series supports backward compatibility in the sense that you can recall a state file from any X-Series model number and any version of X-Series software. This is only possible if part of the recalling process goes through a limiting step after recalling the mode settings, at least for settings that may vary with version number, model number, option and license differences. If you try to recall a state file onto an instrument with less capability than what was available on the instrument during the save, the recall will ignore the state it doesn't support and it will limit the recalled setting to what it allows.</p> <p>Example: if the saved state includes preamp ON, but the recalling instrument does not have a preamp; the preamp is limited to OFF. Conversely, if you save a state without a preamp, the preamp is OFF in the state file. When this saved file is recalled on an instrument with a licensed preamp, the preamp is changed to OFF. Another example is if the saved state has center frequency set to 20 GHz, but the instrument recalling the saved state is a different model and only supports 13.5 GHz. In this case, the center frequency is limited along with any other frequency based settings. Since the center frequency can't be preserved in this case, the recall limiting tries to at least preserve span to keep the measurement setup as intact as possible.</p> <p>It may be appropriate to issue a warning if the state is limited on the recall; warnings do not go out to SCPI so this would only affect the manual user.</p> <p>Note that there is no state file compatibility outside of the X-Series. For example, you cannot recall a state file from ESA or PSA.</p>
Initial S/W Revision	Prior to A.02.00

State

The Recall State menu lets you choose a register or file from which to recall the state.

The content of a state file includes all of the settings and data required to return the analyzer as closely as possible to the Mode it was in, with the exact settings that were in place, when the save occurred. The Mode settings in each state file include the settings that are affected by Mode Preset, as well as the additional settings affected by Restore Mode Defaults; all of the Mode's settings. In addition, all of the settings of the Input/Output system are included, even though they are outside of the Mode's state, because they are needed to restore the complete setup. Persistent System settings (for example, GPIB address) are not affected by either a Mode Preset or Restore Mode Defaults, nor are they included in a saved State file.

Since each state file is only for one Mode, the settings for other Modes are unaffected when it is loaded. Recall State will cause a mode switch if the state being recalled is not from the current active mode.

After the recall completes, the message "File <filename> recalled" or "Recalled State Register <register number>" is displayed.

For rapid recalls, the State menu lists 16 registers that you can choose from to recall. Pressing a Register key initiates the recall. You can also select a file from which to recall.

The default path for all State Files is:

My Documents\<mode name>\state

where <mode name> is the parameter used to select the mode with the INST:SEL command (for example, SA for the Spectrum Analyzer).

See ["More Information" on page 995](#).

Key Path	Recall
Mode	All
Remote Command	:MMEMory:LOAD:STATe <filename>
Example	:MMEM:LOAD:STAT "myState.state" This recalls the file myState.state on the default path
Example	MMEM:LOAD:STAT "MyStateFile.state" This loads the state file data (on the default file directory path) into the instrument state.
Notes	<p>When you pick a file to recall, the analyzer first verifies that the file is recallable in the current instrument by checking the software version and model number of the instrument. If everything matches, a full recall proceeds by aborting the currently running measurement, clearing any pending operations, and then loading the State from the saved state file. You can open state files from any mode, so recalling a State file switches to the mode that was active when the save occurred. After switching to the mode of the saved state file, mode settings and data (if any for the mode) are loaded with values from the saved file. The saved measurement of the mode becomes the newly active measurement and the data relevant to the measurement (if there is any) is recalled.</p> <ul style="list-style-type: none"> • If there is a mismatch between file version or model number or instrument version or model number, the recall function tries to recall as much as possible and returns a warning message. It may limit settings that differ based on model number, licensing or version number. <p>After recalling the state, the Recall State function does the following:</p> <ul style="list-style-type: none"> • Makes the saved measurement for the mode the active measurement. • Clears the input and output buffers. • Status Byte is set to 0.

	<ul style="list-style-type: none"> • Executes a *CLS <p>If the file specified is empty an error is generated. If the specified file does not exist, another error is generated. If there is a mismatch between the file and the proper file type, an error is generated. If there is a mismatch between file version or model number or instrument version or model number, a warning is displayed. Then it returns to the State menu and File Open dialog goes away.</p> <p>After the Recall, the analyzer exits the Recall menu and returns to the previous menu.</p>
Backwards Compatibility SCPI	:MMEMory:LOAD:STATe 1,<filename>
Initial S/W Revision	Prior to A.02.00

More Information

In measurements that support saving Traces, for example, Swept SA, the Trace data is saved along with the State in the State file. When recalling the State, the Trace data is recalled as well. Traces are recalled exactly as they were stored, including the writing mode and update and display modes. If a Trace was updating and visible when the State was saved, it will come back updating and visible, and its data will be rewritten right away. When you use State to save and recall traces, any trace whose data must be preserved should be placed in View or Blank mode before saving.

The following table describes the Trace Save and Recall possibilities:

You want to recall state and one trace's data, leaving other traces unaffected.	Save Trace+State from 1 trace. Make sure that no other traces are updating (they should all be in View or Blank mode) when the save is performed.	On Recall, specify the trace you want to load the one trace's data into. This trace will load in View. All other traces' data will be unaffected, although their trace mode will be as it was when the state save was performed.
You want to recall all traces	Save Trace+State from ALL traces.	On Recall, all traces will come back in View (or Blank if they were in Blank or Background when saved)
You want all traces to load exactly as they were when saved.	Save State	On recall, all traces' mode and data will be exactly as they were when saved. Any traces that were updating will have their data immediately overwritten.

From File...

When you press "From File", the analyzer brings up a Windows dialog and a menu entitled "File Open." This menu allows you to navigate to the various fields in the Windows dialog without using a keyboard or mouse. The Tab and Arrow keys can also be used for dialog navigation.

10 Spectrum Emission Mask Measurement Recall

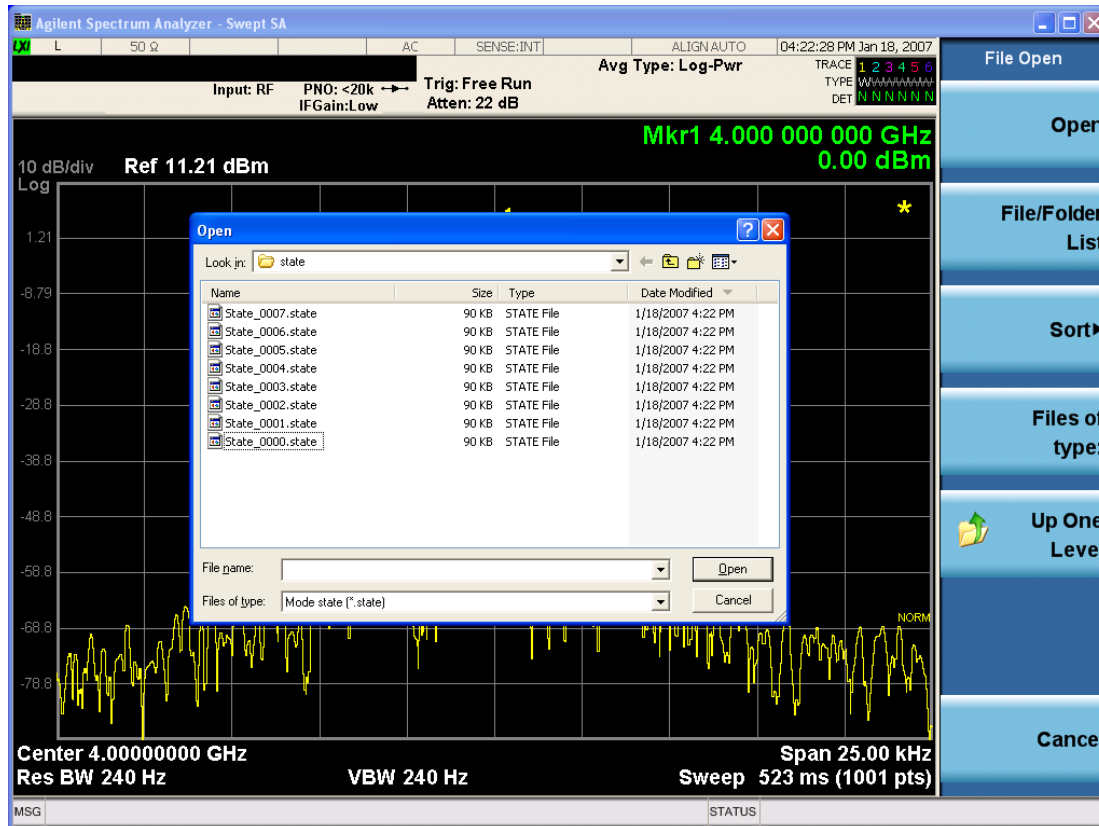

Listed below are the functions of the various fields in the dialog, and the corresponding softkeys:

Open

Performs the recall of the specified file. While the recall is being performed, the floppy icon appears briefly in the Meas bar.

File/Folder List

Enables you to navigate to the center of the dialog that contains the list of files and folders. Once here you can get information about the file and use the tab keys to navigate to the other fields in the dialog, such as Look In.

Look In

The Look In field shows the path from which the file will be recalled and allows you to change the path using the up and down arrow keys to navigate to other paths; the Enter key to open a directory; and the Backspace key to go back one directory. The **Look In field** first uses the last path from the Save As dialog **Save In:** path for that same file type. There is no softkey for directly navigating to the Look In field, but you can use the left tab to get here from the File/Folder List.

User specified paths are remembered when you leave and return to a Mode and are reset back to the default using Restore Mode Defaults.

Sort

Accesses a menu that enables you to sort the files within the File Open dialog. Only one sorting type can be selected at a time and the sorting happens immediately. The sorting types are By Date, By Name, By extension, and By Size.

Files of Type

This field shows the file suffix for the type of file you have selected to recall. For example, if you navigated here while recalling State, "Mode state (*.state)" is in the field. If you navigated here while recalling Trace, ""Mode state (*.trace)" is in the field. If you navigated here while importing a trace data file, "Trace Data (*.csv)" is in the field. For some file types, there is more than one choice in the dropdown menu, which you can select by using the up and down arrow keys and Enter.

Up One Level

This key corresponds to the icon of a folder with the up arrow that is in the tool bar of the dialog. When pressed, it causes the file and folder list to navigate up one level in the directory structure. The Backspace key does the same thing.

Cancel

This key corresponds to the Cancel selection in the dialog. It causes the current **Open** request to be cancelled. The ESC key does the same thing.

Key Path	Recall, State
Notes	Brings up the Open dialog for recalling a State Save Type
Initial S/W Revision	Prior to A.02.00

Edit Register Names

You may enter a custom name on any of the Register keys, to help you remember what you are using that state to save. To do this, press the Edit Register Names key, choose the register whose name you wish to edit, and then enter the desired label using the Alpha Editor or an external PC keyboard.

The maximum number of characters that can be added is 30. In most cases, 30 characters will fit on two lines of the key.

For more information and the SCPI command, see Edit Register Names under the Save, State function.

Key Path	Recall, State
Mode	All
Dependencies	N9060A-7FP or N9060B-2FP license required to edit the register names. When the feature is not licensed, sending the SCPI command generates an error, -221, "Settings conflict;Option not available"
Initial S/W Revision	A.11.00

Register 1 thru Register 16

Selecting any one of these register keys causes the State of the mode from the specified Register to be recalled. Each of the register keys annotates whether it is empty or at what date and time it was last

modified. In addition, you can use the Edit Register Names key under Save, State to enter custom names for each register.

NOTE

In products that run multiple instances of the X-Series Application, recalling the same register name on each instance is a way to share setups between the instances.

Registers are shared by all modes, so recalling from any one of the registers will cause a mode switch to the mode that was active when the save to the Register occurred.

Although these 16 registers are the only registers available from the front panel, there are 128 state registers available in the instrument. Registers 17–128 are only available from the SCPI interface, using the *RCL command.

After the recall completes, the message "Register <register number> recalled" appears in the message bar. If you are in the Spectrum Analyzer Mode, and you are recalling a register that was saved in the Spectrum Analyzer Mode, then after the recall, you will still be in the Recall Register menu. If the Recall causes you to switch modes, then after the Recall, you will be in the Frequency menu.

If a requested register is empty an error is generated.

Key Path	Recall, State
Example	*RCL 1
Range	1–16 from front panel, 1–128 from SCPI
Readback	Date and time with seconds resolution are displayed on the key OR A custom name of up to 30 characters entered using the Save, State, Edit Register Names key OR “(empty)” if no prior save operation has been performed to this register.
Initial S/W Revision	Prior to A.02.00
Modified at S/W Revision	Prior to A.11.00

Register 1 thru Register 16

Selecting any one of these register keys causes the State of the mode from the specified Register to be recalled. Each of the register keys annotates whether it is empty or at what date and time it was last modified. In addition, you can use the Edit Register Names key under Save, State to enter custom names for each register.

NOTE

In products that run multiple instances of the X-Series Application, recalling the same register name on each instance is a way to share setups between the instances.

Registers are shared by all modes, so recalling from any one of the registers will cause a mode switch to the mode that was active when the save to the Register occurred.

Although these 16 registers are the only registers available from the front panel, there are 128 state registers available in the instrument. Registers 17–128 are only available from the SCPI interface, using the *RCL command.

After the recall completes, the message "Register <register number> recalled" appears in the message bar. If you are in the Spectrum Analyzer Mode, and you are recalling a register that was saved in the Spectrum Analyzer Mode, then after the recall, you will still be in the Recall Register menu. If the Recall causes you to switch modes, then after the Recall, you will be in the Frequency menu.

If a requested register is empty an error is generated.

Key Path	Recall, State
Example	*RCL 1
Range	1-16 from front panel, 1-128 from SCPI
Readback	Date and time with seconds resolution are displayed on the key OR A custom name of up to 30 characters entered using the Save, State,Edit Register Names key OR “(empty)” if no prior save operation has been performed to this register.
Initial S/W Revision	Prior to A.02.00
Modified at S/W Revision	Prior to A.11.00

Sequences

These keys allow you to import a Tab separated or .txt file that will automatically setup all the parameters required for building a Sequence. The parameters will automatically be loaded into the Stated Sequencer.

Once selected, in order to import the selected Sequence Type you must select the Open key in the Source Sequence menu.

Key Path	Recall, Sequences
Mode	All
Remote Command	:MMEMory:LOAD:SEQuences: SLIS ALIS SAALIS "MySequence.txt"
Example	:MMEM:LOAD:SEQ:SLIS "MySequence.txt"
Notes	Available file types are: –CSV (Comma delimited) (*.csv) –Text (Tab delimited) (*.txt)
Initial S/W Revision	A.05.00

Source Sequence

The list of parameters, that configure steps, that makes up a sequence for the Source.

The Source sequence is a sequence of flexible configurable steps that can be set anywhere in the instruments frequency range.

Key Path	Recall,Sequences
----------	------------------

Example	:MMEM:LOAD:SEQ:SLIS "MySequence.txt"
Dependencies	Only available in XOBT
Initial S/W Revision	A.05.00

Open...

When you press “Open”, the analyzer brings up a Windows dialog and a menu entitled “**File Open.**” This menu allows you to navigate to the various fields in the Windows dialog without using a keyboard or mouse. The Tab and Arrow keys can also be used for dialog navigation.

See "[From File...](#)" on page 2060 in Recall, State, for a full description of this dialog and menu.

Key Path	Recall, Data
Notes	The key location is mode-dependent and will vary. Brings up Open dialog for recalling a <mode specific> Save Type
Initial S/W Revision	Prior to A.02.00

Data (Import)

Importing a data file loads data that was previously saved from the current measurement or from other measurements and/or modes that produce compatible data files. The Import Menu only contains Data Types that are supported by the current measurement.

Since the commonly exported data files are in .csv format, the data can be edited by the user prior to importing. This allows you to export a data file, manipulate the data in Excel (the most common PC Application for manipulating .csv files) and then import it.

Importing Data loads measurement data from the specified file into the specified or default destination, depending on the data type selected. Selecting an Import Data menu key will not actually cause the importing to occur, since the analyzer still needs to know from where to get the data. Pressing the Open key in this menu brings up the Open dialog and Open menu that provides you with the options from where to recall the data. Once a filename has been selected or entered in the Open menu, the recall occurs as soon as the Open button is pressed.

Key Path	Recall
Mode	All
Notes	The menu is built from whatever data types are available for the mode. Some keys will be missing completely, so the key locations in the sub-menu will vary. No SCPI command directly controls the Data Type that this key controls. The Data Type is included in the MMEM:LOAD commands.
Dependencies	If a file type is not used by a certain measurement, it is grayed out for that measurement. The key for a file type will not show at all if there are no measurements in the Mode that support it.
Preset	Is not affected by Preset or shutdown, but is reset during Restore Mode Defaults

Readback	The data type that is currently selected
Initial S/W Revision	Prior to A.02.00

Capture Buffer

Capture buffer functionality is available only in Code Domain and Modulation Accuracy measurements. The captured data is raw data which is not processed.

Key Path	Recall, Data
Mode	CDMA2000
Example	MMEM:LOAD:CAPT "MyCaptureData.bin" This loads the file of capture data (on the default file directory path) into the instrument.
Dependencies	Capture buffer data is only available for Code Domain and Modulation Accuracy measurement. In other measurements, this key is grayed out.

Open...

When you press "Open", the analyzer brings up a Windows dialog and a menu entitled "**File Open.**" This menu allows you to navigate to the various fields in the Windows dialog without using a keyboard or mouse. The Tab and Arrow keys can also be used for dialog navigation.

See "[From File...](#)" on page 2060 in Recall, State, for a full description of this dialog and menu.

Key Path	Recall, Data
Notes	The key location is mode-dependent and will vary. Brings up Open dialog for recalling a <mode specific> Save Type
Initial S/W Revision	Prior to A.02.00

Restart

The Restart function restarts the current sweep, or measurement, or set of averaged/held sweeps or measurements. If you are Paused, pressing Restart does a Resume.

The Restart function is accessed in several ways:

- Pressing the Restart key
- Sending the remote command INIT:IMMEDIATE
- Sending the remote command INIT:RESTART

See "[More Information](#)" on page 1002

Key Path	Front-panel key
Remote Command	:INITiate[:IMMEDIATE] :INITiate:RESTART
Example	:INIT:IMM :INIT:REST
Notes	:INITiate:RESTART and :INITiate:IMMEDIATE perform exactly the same function.
Couplings	Resets average/hold count k. For the first sweep overwrites all active (update=on) traces with new current data. For application modes, it resets other parameters as required by the measurement.
Status Bits/OPC dependencies	This is an Overlapped command. The STATUS:OPERation register bits 0 through 8 are cleared. The STATUS:QUESTionable register bit 9 (INTEGRITY sum) is cleared. The SWEEPING bit is set. The MEASURING bit is set.
Backwards Compatibility Notes	For Spectrum Analysis mode in ESA and PSA, the Restart hardkey and the INITiate:RESTART command restart trace averages (displayed average count reset to 1) for a trace in Clear Write, but did not restart Max Hold and Min Hold. In the X-Series, the Restart hardkey and the INITiate:RESTART command restart not only Trace Average, but MaxHold and MinHold traces as well. For wireless comms modes in ESA and PSA, the Restart hardkey and the INITiate:RESTART command restart every measurement, which includes all traces and numeric results. There is no change to this operation.
Initial S/W Revision	Prior to A.02.00

More Information

The **Restart** function first aborts the current sweep/measurement as quickly as possible. It then resets the sweep and trigger systems, sets up the measurement and initiates a new data measurement sequence with a new data acquisition (sweep) taken once the trigger condition is met.

If the analyzer is in the process of aligning when **Restart** is executed, the alignment finishes before the restart function is performed.

Even when set for Single operation, multiple sweeps may be taken when Restart is pressed (for example, when averaging/holding is on). Thus when we say that **Restart** "restarts a measurement," we may mean:

- It restarts the current sweep
- It restarts the current measurement
- It restarts the current set of sweeps if any trace is in Trace Average, Max Hold or Min Hold
- It restarts the current set of measurements if Averaging, or Max Hold, or Min Hold is on for the measurement
- depending on the current settings.

With **Average/Hold Number** (in **Meas Setup** menu) set to 1, or Averaging off, or no trace in Trace Average or Hold, a single sweep is equivalent to a single measurement. A single sweep is taken after the trigger condition is met; and the analyzer stops sweeping once that sweep has completed. However, with **Average/Hold Number** >1 and at least one trace set to **Trace Average, Max Hold, or Min Hold (SA Measurement)** or **Averaging on (most other measurements)**, multiple sweeps/data acquisitions are taken for a single measurement. The trigger condition must be met prior to each sweep. The sweep is stopped when the average count k equals the number N set for **Average/Hold Number**. A measurement average usually applies to all traces, marker results, and numeric results; but sometimes it only applies to the numeric results.

Once the full set of sweeps has been taken, the analyzer will go to idle state. To take one more sweep without resetting the average count, increment the average count by 1, by pressing the step up key while **Average/Hold Number** is the active function, or sending the remote command `CALC:AVER:TCON UP`.

Save

The Save menu lets you choose what you want to save and where you want to save it. Among the types of files you can save are **States**, **Traces**, and **Screen Images**. In addition, an Export (Data) option lets you save a number of data types as CSV files for easy import into Excel and other spreadsheet programs.

Key Path	Front-panel key
Mode	All
Notes	No remote command for this key specifically, but the :MMEM:STORe command is available for specific file types. An example is :MMEM:STOR:STATe <filename>.
Initial S/W Revision	Prior to A.02.00

State

The Save State menu lets you choose a register or file for saving the state.

NOTE In products that run multiple instances of the X-Series Application, all instances share the same register and file location where you want to save the state.

The content of a state file includes all of the settings and data required to return the analyzer as closely as possible to the Mode it was in, with the exact settings which were in place, when the save occurred. The Mode settings in each state file include the settings that are affected by Mode Preset, as well as the additional settings affected by Restore Mode Defaults; all of the Mode's settings. In addition, all of the settings of the Input/Output system are included, even though they are outside of the Mode's state, because they are needed to restore the complete setup. Persistent System settings (for example, Verbose SCPI) are not affected by either Mode Preset or Restore Mode Defaults, nor are they included in a saved State file.

After the save completes, the message "File <filename> saved" or "State Register <register number> saved" is displayed.

For rapid saving, the State menu lists 16 registers to save to. Pressing a Register key initiates the save. You can also select a file to save to.

The default path for all State Files is:

My Documents\<<mode name>\state

where <mode name> is the parameter used to select the mode with the INST:SEL command (for example, SA for the Spectrum Analyzer).

Key Path	Save
Mode	All
Remote Command	:MMEMory:STORe:STATe <filename>
Example	MMEM:STOR:STATe "MyStateFile.state" This stores the current instrument state data in the file MyStateFile.state in the default directory.
Notes	Both single and double quotes are supported for any filename parameter over remote.

After saving to a register, that register's menu key is updated with the date the time, unless a custom label has been entered for that key.

After saving to a register, you remain in the Save State menu, so that you can see the Register key update. After saving to a file, the analyzer automatically returns to the previous menu and any Save As dialog goes away.

Backwards Compatibility SCPI :MMEMory:STORe:STATe 1,<filename>

For backwards compatibility, the above syntax is supported. The "1" is simply ignored. The command is sequential.

Initial S/W Revision Prior to A.02.00

To File . . .

When you press "To File", the analyzer brings up a Windows dialog and a menu entitled "Save As." This menu allows you to navigate to the various fields in the Windows dialog without using a keyboard or mouse. The Tab and Arrow keys can also be used for dialog navigation.

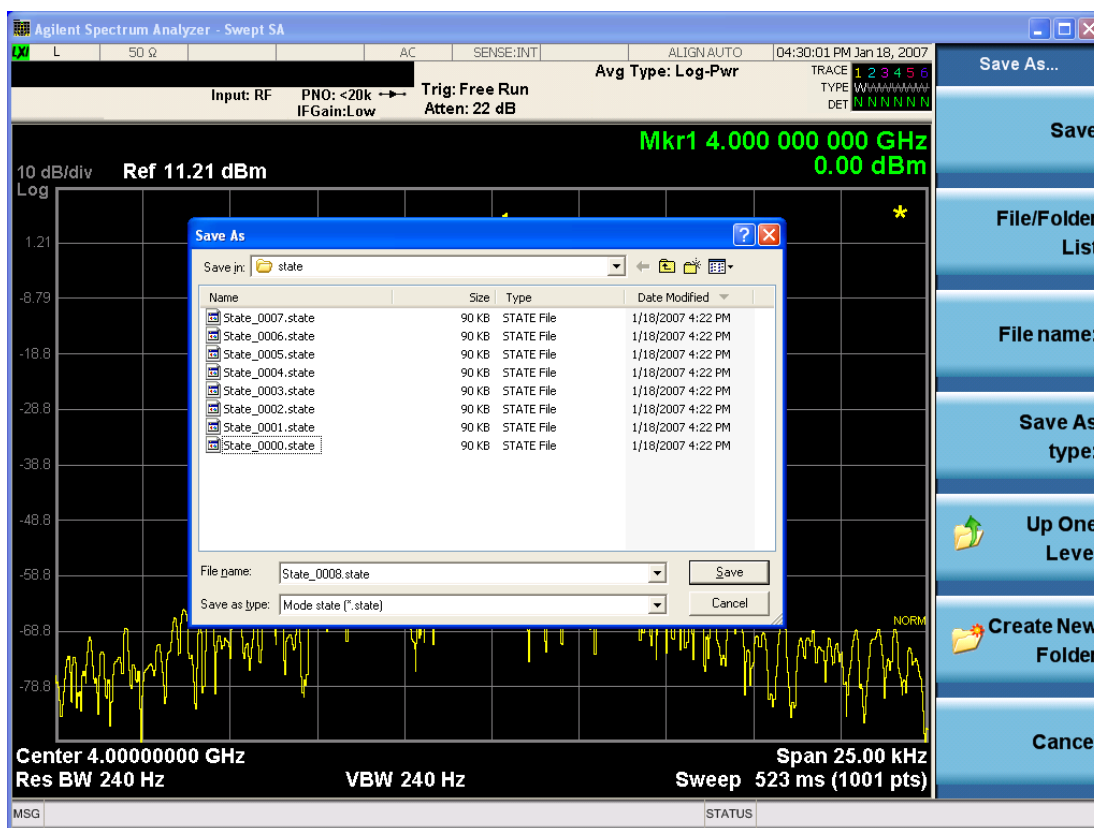

The Listed below

are the functions of the various fields in the dialog, and the corresponding softkeys:

Save

Performs the save to the specified file of the selected type. If the file already exists, a dialog will appear that allows you to replace the existing file by selecting OK, or you can Cancel the request. If you select OK,

the file will be overwritten. Using the C: drive is strongly discouraged, since it runs the risk of being overwritten during an instrument software upgrade.

While the save is being performed, the floppy icon appears briefly in the Meas bar.

File/Folder List

Enables you to navigate to the center of the dialog that contains the list of files and folders. Once here you can get information about the file and use the tab keys to navigate to the other fields in the dialog, such as Save In.

Save In

The Save In field shows the path to which the file will be saved and allows you to change the path using the up and down arrow keys to navigate to other paths; the Enter key to open a directory; and the Backspace key to go back one directory. The **Save In field** defaults to the default path for this type of file and remembers the last path you used to save this type of file. There is no softkey for directly navigating to the Save In field but you can use left tab to get here from the File/Folder List.

User specified paths are remembered when you leave and return to a Mode and are reset back to the default using Restore Mode Defaults.

File Name

The File Name field is initially loaded with an automatically generated filename specific to the appropriate Save Type. The automatically generated filename is guaranteed not to conflict with any filename currently in the directory. You may replace or modify this filename using the File Name key. See the ["Quick Save " on page 2056](#) documentation for more on the automatic file naming algorithm.

When you press the File Name key the analyzer displays the Alpha Editor. Use the knob to choose the letter to add and the front-panel Enter key to add the letter to the file name. The BK character moves you back and the FW character moves you forward in the filename. The Select key on the front panel generates a space character. When you are done entering the filename press the Done softkey. This returns back to the **File Open** dialog and menu, but does not cause the save to occur.

Save As Type

This field shows the file suffix for the type of file you have selected to save. For example, if you navigated here while saving State, "Mode state (*.state)" is in the field. If you navigated here from saving Trace, ""Mode state (*.trace)" is in the field. If you navigated here while exporting a trace data file, "Trace Data (*.csv)" is in the field. For some file types, there is more than one choice in the dropdown, which you can select by using the up and down arrow keys and Enter.

Up One Level

This key corresponds to the icon of a folder with the up arrow that is in the tool bar of the dialog. When pressed, it causes the file and folder list to navigate up one level in the directory structure. The Backspace key does the same thing.

Create New Folder

This key corresponds to the icon of a folder with the "*" that is in the tool bar of the dialog. When pressed, a new folder is created in the current directory with the name **New Folder** and you can enter a new folder name using the Alpha Editor.

Cancel

This key corresponds to the Cancel selection in the dialog. It causes the current **Save As** request to be cancelled. The ESC key does the same thing.

Key Path	Save, State
Mode	All
Notes	Brings up Save As dialog for saving a State Save Type
Initial S/W Revision	Prior to A.02.00

Edit Register Names

You may enter a custom name on any of the Register keys, to help you remember what you are using that state to save. To do this, press the Edit Register Names key, choose the register whose name you wish to edit, and then enter the desired label using the Alpha Editor or an external PC keyboard.

The maximum number of characters that can be added is 30. In most cases, 30 characters will fit on two lines of the key.

See ["More Information" on page 1007](#)

Key Path	Save, State
Mode	All
Remote Command	:MMEMory:REGister:STATe:LABel <reg number>,"label" :MMEMory:REGister:STATe:LABel? <reg number>
Example	:MMEM:REG:STAT:LAB 1,"my label"
Notes	<reg number> is an integer from 1 to 16. If the SCPI specifies an invalid register number an error message is generated, -222,"Data out of range;Invalid register label number" "label" is a string from 0 to 30 characters in length. If a label exceeds 30 characters, an error message is generated, -150,"String data error;Label clipped to 30 characters" "label" of length 0 erases the custom label and restores the default (time and date) label. E.g.: :MMEM:REG:STAT:LAB 1,""
Dependencies	N9060A-7FP or N9060B-2FP license required to edit the register names. When the feature is not licensed, sending this command generates an error, -221,"Settings conflict;Option not available"
Preset	The names are unaffected by Preset or power cycle but are set to the default label (time and date) on a "Restore System Defaults->Misc"
Initial S/W Revision	A.11.00

More Information

When you edit one of the register names, the time and date field will be replaced by the custom name.

If you delete all the characters in the custom name, it restores the default (time and date).

The register names are stored within the state files, but they are not part of the instrument state; that is, once you have edited a register name, loading a new state will not change that register name. Another

consequence of this is that the names will be persistent through a power cycle. Also, if a named state file is transferred to another analyzer, it will bring its custom name along with it.

If you try to edit the name of an empty register, the analyzer will first save the state to have a file to put the name in. If you load a named state file into an analyzer with older firmware it will ignore the metadata.

The *SAV and *RCL commands will not be affected by the custom register names, nor will the MMEM commands.

Register 1 thru Register 16

Selecting any one of these register menu keys causes the State of the currently active mode to be saved to the specified Register. The registers are provided for rapid saving and recalling, since you do not need to specify a filename or navigate to a file. Each of the register menu keys annotates whether it is empty or at what date and time it was last modified. In addition, you can use the Edit Register Names key to enter custom names for each register.

NOTE

In products that run multiple instances of the X-Series Application, save with different register name if you do not want to overwrite the register of another running instance.

Although these 16 registers are the only registers available from the front panel, there are 128 state registers available in the instrument. Registers 17–128 are only available from the SCPI interface, using the *SAV command.

There is one set of 128 state registers in the instrument, not one set for each Mode. When a state is saved, the Mode it was saved from is saved with it; then when it is recalled, the instrument switches to that Mode.

After the save completes, the corresponding register menu key annotation is updated with the date and time and the message "Register <register number> saved" is displayed.

Key Path	Save, State
Mode	All
Example	*SAV 1
Range	1–16 from front panel, 1–128 from SCPI
Readback	Date and time with seconds resolution are displayed on the key OR A custom name of up to 30 characters entered using the Edit Register Names key OR “(empty)” if no prior save operation has been performed to this register.
Initial S/W Revision	Prior to A.02.00
Modified at S/W Revision	A.11.00

Register 1 thru Register 16

Selecting any one of these register menu keys causes the State of the currently active mode to be saved to the specified Register. The registers are provided for rapid saving and recalling, since you do not need to specify a filename or navigate to a file. Each of the register menu keys annotates whether it is empty or at

what date and time it was last modified. In addition, you can use the Edit Register Names key to enter custom names for each register.

NOTE In products that run multiple instances of the X-Series Application, save with different register name if you do not want to overwrite the register of another running instance.

Although these 16 registers are the only registers available from the front panel, there are 128 state registers available in the instrument. Registers 17–128 are only available from the SCPI interface, using the *SAV command.

There is one set of 128 state registers in the instrument, not one set for each Mode. When a state is saved, the Mode it was saved from is saved with it; then when it is recalled, the instrument switches to that Mode.

After the save completes, the corresponding register menu key annotation is updated with the date and time and the message "Register <register number> saved" is displayed.

Key Path	Save, State
Mode	All
Example	*SAV 1
Range	1–16 from front panel, 1–128 from SCPI
Readback	Date and time with seconds resolution are displayed on the key OR A custom name of up to 30 characters entered using the Edit Register Names key OR “(empty)” if no prior save operation has been performed to this register.
Initial S/W Revision	Prior to A.02.00
Modified at S/W Revision	A.11.00

Mass Storage Catalog (Remote Command Only)

Key path	SCPI Only
Remote Command	:MMEMory:CATalog? [<directory_name>]
Notes	The string must be a valid logical path. Queries disk usage information (drive capacity, free space available) and obtains a list of files and directories in a specified directory in the following format: <numeric_value>,<numeric_value>,{<file_entry>} It returns two numeric parameters and as many strings as there are files and directories. The first parameter indicates the total amount of storage currently used in bytes. The second parameter indicates the total amount of storage available, also in bytes. The <file_entry> is a string. Each <file_entry> indicates the name, type, and size of one file in the directory list: <file_name>,<file_type>,<file_size> As the windows file system has an extension that indicates file type, <file_type> is always empty. <file_size> provides the size of the file in bytes. For directories, <file_entry> is surrounded by square brackets and both <file_type> and <file_size> are empty
Initial S/W Revision	Prior to A.02.00

Mass Storage Change Directory (Remote Command Only)

Key path	SCPI Only
Remote Command	:MMEMory:CDIRectory [<directory_name>] :MMEMory:CDIRectory?
Notes	The string must be a valid logical path. Changes the default directory for a mass memory file system. The <directory_name> parameter is a string. If no parameter is specified, the directory is set to the *RST value. At *RST, this value is set to the default user data storage area, that is defined as System.Environment.SpecialFolder.Personal. Query returns full path of the default directory.
Initial S/W Revision	Prior to A.02.00

Mass Storage Copy (Remote Command Only)

Key path	SCPI Only
Remote Command	:MMEMory:COPY <string>,<string>[,<string>,<string>]
Notes	The string must be a valid logical path. Copies an existing file to a new file or an existing directory to a new directory. Two forms of parameters are allowed. The first form has two parameters. In this form, the first parameter specifies the source, and the second parameter specifies the destination. The second form has four parameters. In this form, the first and third parameters specify the source. The second and fourth parameters specify the directories. The first pair of parameters specifies the source. The second pair specifies the destination. An error is generated if the source doesn't exist or the destination file already exists. This command will generate an "access denied" error if the destination is a restricted folder (e.g., C:\Windows) and the current user does not have Power User or Administrator privileges.

Mass Storage Device Copy (Remote Command Only)

This command transfers data to/from a file and a peripheral device.

Key path	SCPI Only
Remote Command	:MMEMory:COPY:DEvice <source_string>,<dest_string>
Notes	The strings must be a valid logical path or a valid device keyword. If the dest_string is a device keyword, the data is copied from the source file to the device. If the source_string is a device keyword, the data is copied to the source file from the device. Valid device keywords are: SNS (smart noise source) An error is generated if the file or device is not found.

Mass Storage Delete (Remote Command Only)

Key path	SCPI Only
Remote Command	:MMEMory:DELeTe <file_name>[,<directory_name>]
Notes	The string must be a valid logical path. Removes a file from the specified directory. The <file_name> parameter specifies the file name to be removed. This command will generate an “access denied” error if the file is in a restricted folder (e.g., C:\Windows) and the current user does not have Power User or Administrator privileges.
Initial S/W Revision	Prior to A.02.00

Mass Storage Data (Remote Command Only)

Creates a file containing the specified data OR queries the data from an existing file.

Key path	SCPI Only
Remote Command	:MMEMory:DATA <file_name>, <data> :MMEMory:DATA? <file_name>
Notes	The string must be a valid logical path. The command form is MMEMory:DATA <file_name>,<data>. It loads <data> into the file <file_name>. <data> is in 488.2 block format. <file_name> is string data. The query form is MMEMory:DATA? <file_name> with the response being the associated <data> in block format.
Initial S/W Revision	Prior to A.02.00

Mass Storage Make Directory (Remote Command Only)

Key path	SCPI Only
Remote Command	:MMEMory:MDIRectory <directory_name>
Notes	The string must be a valid logical path. Creates a new directory. The <directory_name> parameter specifies the name to be created. This command will generate an “access denied” error if the new directory would be in a restricted folder (e.g., C:\Windows) and the current user does not have Power User or Administrator privileges.
Initial S/W Revision	Prior to A.02.00

Mass Storage Move (Remote Command Only)

Key path	SCPI Only
Remote Command	:MMEMory:MOVE <string>,<string>[,<string>,<string>]
Notes	The string must be a valid logical path. Moves an existing file to a new file or an existing directory to a new directory.

Two forms of parameters are allowed. The first form has two parameters. In this form, the first parameter specifies the source, and the second parameter specifies the destination.

The second form has four parameters. In this form, the first and third parameters specify the source. The second and fourth parameters specify the directories. The first pair of parameters specifies the source. The second pair specifies the destination. An error is generated if the source doesn't exist or the destination file already exists.

This command will generate an "access denied" error if the destination is a restricted folder (e.g., C:\Windows) and the current user does not have Power User or Administrator privileges.

Initial S/W Revision Prior to A.02.00

Mass Storage Remove Directory (Remote Command Only)

Key path SCPI Only

Remote Command :MMEMory:RDIRECTory <directory_name>

Notes

The string must be a valid logical path.

Removes a directory. The <directory_name> parameter specifies the directory name to be removed. All files and directories under the specified directory shall also be removed.

This command will generate an "access denied" error if the folder is a restricted folder (e.g., C:\Windows) or is in a restricted folder and the current user does not have Power User or Administrator privileges.

Initial S/W Revision Prior to A.02.00

Mass Storage Determine Removable Media (Remote Command Only)

This command is used to determine if any removable media devices are connected to the instrument. Primarily, these are USB memory devices plugged-in to the front panel or rear panel USB ports. On instruments with PC6 or PC7 CPU's, one SD card slot is available for removable media. The instrument's primary disk drive is not a removable media device.

Key Path SCPI Only

Remote Command :MMEMory:RMEDIA:LIST?

Notes

The return value will be a string containing a list of partition identifiers which are removable media devices. Each identifier will be separated by a comma. If no removable media is present, an empty string will be returned.

Examples:

One removable device present will result in a return string of "F:".

Two removable devices present will result in a return string of "F:,G:".

No removable devices present will result in a return string of "".

Initial S/W Revision x.15.00

Mass Storage Determine Removable Media Label (Remote Command Only)

This command is used to set or query a removable media device's label.

Key Path	SCPI Only
Remote Command	:MMEMory:RMEDia:LABel <partition>,<string> :MMEMory:RMEDia:LABel? <partition>
Example	MMEM:RMED:LAB "F:","My Device"
Notes	If the <partition> specified does not exist or is not a removable media device the error -252,"Missing Media" will be generated. Setting the removable media label requires Administrative privileges. If the currently logged in user does not have appropriate privileges the error "-221.9900,Settings conflict;Administrator privileges required" is generated.
Initial S/W Revision	x.15.00

Mass Storage Determine Removable Media Write-protect status (Remote Command Only)

This command is used to query a removable media device's write-protect status.

Key Path	SCPI Only
Remote Command	:MMEMory:RMEDia:WPRotect? <partition>
Example	MMEM:RMED:WPR? "F:"
Notes	The return value is 1 if the device is write-protected, and 0 if the device is write-enabled. If the <partition> specified does not exist or is not a removable media device the error -252,"Missing Media" will be generated.
Preset	The return value will be depending on SD card installed.
Initial S/W Revision	x.15.00

Mass Storage Determine Removable Media size (Remote Command Only)

This command is used to query a removable media device's total memory size (not available memory size).

Key Path	SCPI Only
Remote Command	:MMEMory:RMEDia:SIZE? <partition>
Example	MMEM:RMED:SIZE? "F:"
Notes	The return value is integer value in GBytes. Any device which is less than 1 GB will return 0 GB. If the <partition> specified does not exist or is not a removable media device the error -252,"Missing Media" will be generated.
Initial S/W Revision	x.15.00

Sequences

These keys allow you to save a Tab separated or CSV file of the setup parameters required to build a Sequence.

In order to save you must select the Save As button and choose a destination folder.

Key Path	Save, Sequences
Mode	All
Remote Command	:MMEM:STOR:SEQ:SEquences: SLISt ALISt SAALISt SStep "MySequence.txt"
Example	:MMEM:STOR:SEQ:SLISt "MySequence.txt"
Notes	Available file types are: –CSV (Comma delimited) (*.csv) –Text (Tab delimited) (*.txt)
Initial S/W Revision	A.05.00

Source Sequence

The list of parameters, that configure steps, that makes up a sequence for the Source.

The Source sequence is a sequence of flexible configurable steps that can be set anywhere in the instruments frequency range.

Key Path	Save, Sequences
Example	:MMEM:STOR:SEQ:SLIS "MySequence.txt"
Dependencies	Only available in XOBT
Initial S/W Revision	A.05.00

Save As . . .

This menu lets you select the location where you can save the Sequence. This menu is a standard Windows® dialog with Save As menu keys. The "File Name" field in the Save As dialog is initially loaded with an automatically generated filename specific to the appropriate Save Type. The automatically generated filename is guaranteed not to conflict with any filename currently in the directory. You may replace or modify this filename using the File Name softkey. See the Quick Save key documentation for more on the automatic file naming algorithm.

The default path for all Sequence Files is:

My Documents\Sequences

Key Path	Save, Sequences
Mode	All

Notes	Brings up Save As dialog for saving a Sequence Save Type
Initial S/W Revision	A.05.00

Data (Export)

Exporting a data file stores data from the current measurement to mass storage files. The Export Menu only contains data types that are supported by the current measurement.

Since the commonly exported data files are in .csv format, the data can be edited by you prior to importing. This allows you to export a data file, manipulate the data in Excel (the most common PC Application for manipulating .csv files) and then import it.

Selecting an Export Data menu key will not actually cause the exporting to occur, since the analyzer still needs to know where you wish to save the data. Pressing the Save As key in this menu brings up the Save As dialog and Save As menu that allows you to specify the destination file and directory. Once a filename has been selected or entered in the Open menu, the export will occur as soon as the Save key is pressed.

Key Path	Save
Mode	All
Notes	The menu is built from whatever data types are available for the mode. So the key locations in the sub menu will vary. No SCPI command directly controls the Data Type that this key controls. The Data Type is included in the MMEM:STORe commands.
Dependencies	If a file type is not used by a certain measurement, that type is grayed out for that measurement. The key for a file type will not show at all if there are no measurements in the Mode that support it.
Preset	Is not affected by a Preset or shutdown, but is reset during Restore Mode Defaults
Readback	The data type that is currently selected
Initial S/W Revision	Prior to A.02.00

Measurement Results

Pressing this key selects Meas Results as the data type to be exported.

The Meas Results file contains information that describes the current state of the analyzer. It is detailed in ["Meas Results File Contents" on page 1016](#) below.

Key Path	Save, Data
Remote Command	:MMEMory:STORe:RESults <string>
Example	:MMEM:STOR:RES "MeasR_0000.csv"
Notes	If the save is initiated via SCPI and the file already exists, the file will be overwritten. The SCPI command exports Spectrum Emission Mask measurement results to the file specified as the parameter in the current path. The default path is My Documents\ <current mode>\data\SEM\results.

	Using the C: drive is strongly discouraged, since it runs the risk of being overwritten during an instrument software upgrade. The SCPI parameter is a quoted string that specifies the filename. Both single and double quotes are supported for any filename parameter over SCPI.
Dependencies	The current active measurement must be the Spectrum Emission Mask measurement to use this command.
Status Bits/OPC dependencies	Sequential – waits for the previous measurement to complete
Initial S/W Revision	Prior to A.02.00

Meas Results File Contents

A Meas Results File contains measurement results with the following information.

- File ID string, which is “MeasResult”
- Measurement ID following Mode ID, which is “SA:SEM” for example.
- Firmware rev and model number
- Option string
- Automatic Trigger Time
- Automatic Trigger Time State
- Center Frequency
- ChanIntegBW
- ChannelDetector
- ChannelDetectorState
- ChanPwrRefAuto
- ChanResBW
- ChanResBWAUTO
- ChanSpan
- ChanSweepTime
- ChanSweepTimeAuto
- ChanVbwRbwRatio
- ChanVbwRbwRatioAuto
- ChanVideoBW
- ChanVideoBWAUTO
- Electrical Atten

- Electrical Atten Bypass
- Electrical Atten State
- External1 Trigger Delay
- External1 Trigger Delay State
- External1 Trigger Level
- External1 Trigger Slope
- External2 Trigger Delay
- External2 Trigger Delay State
- External2 Trigger Level
- External2 Trigger Slope
- FilterAlpha
- Internal Preamp
- Internal Preamp Band
- Line Trigger Delay
- Line Trigger Delay State
- Line Trigger Slope
- Mechanical Atten
- Mechanical Atten Auto
- OffsetDetector
- OffsetDetectorState
- OffsetLimitAbsStartBTS
- OffsetLimitAbsStartMS
- OffsetLimitAbsStopBTS
- OffsetLimitAbsStopMS
- OffsetLimitFailMaskBTS
- OffsetLimitFailMaskMS
- OffsetLimitRelStartBTS
- OffsetLimitRelStartMS
- OffsetLimitRelStopBTS
- OffsetLimitRelStopMS
- OffsetMeasBWBTS

- OffsetMeasBWMS
- OffsetResolutionBWAUTOBTS
- OffsetResolutionBWAUTOMS
- OffsetResolutionBWBTS
- OffsetResolutionBWMS
- OffsetSideBTS
- OffsetSideMS
- OffsetStartFrequencyBTS
- OffsetStartFrequencyMS
- OffsetStateBTS
- OffsetStateMS
- OffsetStopFrequencyBTS
- OffsetStopFrequencyMS
- OffsetSweepTimeAutoBTS
- OffsetSweepTimeAutoMS
- OffsetSweepTimeBTS
- OffsetSweepTimeMS
- OffsetVbwRbwRatioAutoBTS
- OffsetVbwRbwRatioAutoMS
- OffsetVbwRbwRatioBTS
- OffsetVbwRbwRatioMS
- OffsetVideoBWAUTOBTS
- OffsetVideoBWAUTOMS
- OffsetVideoBWBTS
- OffsetVideoBWMS
- PeakReference
- Periodic Timer Period
- Periodic Timer Sync Source
- Periodic Timer Trigger Delay
- Periodic Timer Trigger Delay State
- PowerReference

- PSDReference
- Radio Device
- RFBurst Trigger Delay
- RFBurst Trigger Delay State
- RFBurst Trigger Level Abs
- RFBurst Trigger Level Rel
- RFBurst Trigger Level Type
- RFBurst Trigger Slope
- RrcFilter
- SemAverageNumber
- SemAverageState
- TotalAtten
- Trigger Holdoff
- Trigger Holdoff State
- TriggerSource
- Video Trigger Delay
- Video Trigger Delay State
- Video Trigger Level
- Video Trigger Slope
- ViewSelection

The file contains these data followed by MeasResult1 to MeasResult12 that flag the start of the measurement results. Each line of Measurement Results consists of twelve comma separated values from MeasResult1 value to MeasResult12 value. MeasResult1 contains the same results as MEAS/READ/FETCH:SEMask1; MeasResult2, MEAS/READ/FETCH:SEMask2; MeasResult3, MEAS/READ/FETCH:SEMask3;... (continues in the same manner)

The exported file is in CSV format, with a.csv extension. The Meas Results file, when imported into Excel, shows the following data:

MeasResult	
SA:SEM	
A.10.53	N90 30A
526 ALV ATP B1X B1Y B25 B40 BBA CR3	1

CRP DCF DDA		
DP2 DRD EA3		
EDP EMC EP1		
ERC ESC ESP		
EXM FSA LFE		
LNP MAT		
MPB NFE		
NUL P26 PFR		
PNC RTL RTS		
S40 SB1 SEC		
SM1 TVT YAS		
YAV		
Automatic Trigger Time	0.1	
Automatic Trigger Time State	FALS E	
Center Frequency	1.33 E+10	
ChanIntegBW	384 000 0	384 000 0
ChannelDetector	Average	
ChannelDetectorState	TRUE	
ChanPwrRefAuto	TRUE	
ChanResBW	100 000	100 000
ChanResBWAuto	FALS E	FALS E
ChanSpan	500 000 0	500 000 0
ChanSweepTime	0.00 250 7	0.00 250 7
ChanSweepTimeAuto	TRUE	TRUE
ChanVbwRbwRatio	1	1
ChanVbwRbwRatioAuto	FALS E	FALS E
ChanVideoBW	100	100

	000	000
ChanVideoBW Auto	TRUE	TRUE
Electrical Atten	0	
Electrical Atten Bypass	TRUE	
Electrical Atten State	FALS E	
External1 Trigger Delay	1.00 E-06	
External1 Trigger Delay State	FALS E	
External1 Trigger Level	1.2	
External1 Trigger Slope	Posit ive	
External2 Trigger Delay	1.00 E-06	
External2 Trigger Delay State	FALS E	
External2 Trigger Level	1.2	
External2 Trigger Slope	Posit ive	
FilterAlpha	0.22	
Internal Preamp	FALS E	
Internal Preamp Band	Low	
Line Trigger Delay	1.00 E-06	
Line Trigger Delay State	FALS E	
Line Trigger Slope	Posit ive	
Mechanical Atten	10	
Mechanical Atten Auto	TRUE	
OffsetDetecto	Peak	

r						
OffsetDetectorState	TRUE					
OffsetLimitAbsStartBTS	-14	-14	-26	-13	-13	-13
OffsetLimitAbsStartMS	-14	-14	-26	-13	-13	-13
OffsetLimitAbsStopBTS	-14	-26	-26	-13	-13	-13
OffsetLimitAbsStopMS	-14	-26	-26	-13	-13	-13
OffsetLimitFailMaskBTS	ABSolute	ABSolute	ABSolute	ABSolute	ABSolute	ABSolute
OffsetLimitFailMaskMS	ABSolute	ABSolute	ABSolute	ABSolute	ABSolute	ABSolute
OffsetLimitRelStartBTS	-30	-30	-30	-30	-30	-30
OffsetLimitRelStartMS	-30	-30	-30	-30	-30	-30
OffsetLimitRelStopBTS	-30	-30	-30	-30	-30	-30
OffsetLimitRelStopMS	-30	-30	-30	-30	-30	-30
OffsetMeasureBWBTS	1	1	1	1	1	1
OffsetMeasureBWMS	1	1	1	1	1	1
OffsetResolutionBWAutoBTS	FALSE	FALSE	FALSE	FALSE	FALSE	FALSE
OffsetResolutionBWAutoMS	FALSE	FALSE	FALSE	FALSE	FALSE	FALSE
OffsetResolutionBWAutoBTS	30000	30000	30000	1000000	100000	100000
OffsetResolutionBWMS	30000	30000	30000	1000000	100000	100000
OffsetSideBTS	Both	Both	Both	Both	Both	Both
OffsetSideMS	Both	Both	Both	Both	Both	Both
OffsetStartFrequencyBTS	2515000	2715000	3515000	4000000	800000	125000

OffsetStartFrequencyMS	251 500 0	271 500 0	351 500 0	4000000	800 000 0	125 000 00
OffsetStateBTS	TRUE	TRUE	TRUE	TRUE	TRUE	FALSE
OffsetStateMS	TRUE	TRUE	TRUE	TRUE	TRUE	FALSE
OffsetStopFrequencyBTS	271 500 0	351 500 0	400 000 0	8000000	125 000 00	150 000 00
OffsetStopFrequencyMS	271 500 0	351 500 0	400 000 0	8000000	125 000 00	150 000 00
OffsetSweepTimeAutoBTS	TRUE	TRUE	TRUE	TRUE	TRUE	TRUE
OffsetSweepTimeAutoMS	TRUE	TRUE	TRUE	TRUE	TRUE	TRUE
OffsetSweepTimeBTS	0.01 733 3	0.06 932	0.04 202 7	0.002053	0.00 225 3	0.00 125 3
OffsetSweepTimeMS	0.01 733 3	0.06 932	0.04 202 7	0.002053	0.00 225 3	0.00 125 3
OffsetVbwRbwRatioAutoBTS	FALSE	FALSE	FALSE	FALSE	FALSE	FALSE
OffsetVbwRbwRatioAutoMS	FALSE	FALSE	FALSE	FALSE	FALSE	FALSE
OffsetVbwRbwRatioBTS	0.01	0.01	0.01	0.01	0.01	0.01
OffsetVbwRbwRatioMS	0.01	0.01	0.01	0.01	0.01	0.01
OffsetVideoBWAutoBTS	TRUE	TRUE	TRUE	TRUE	TRUE	TRUE
OffsetVideoBWAutoMS	TRUE	TRUE	TRUE	TRUE	TRUE	TRUE
OffsetVideoBW BMS	300	300	300	10000	100 00	100 00
OffsetVideoBW MS	300	300	300	10000	100 00	100 00
PeakReference	- 82.9 957					

10 Spectrum Emission Mask Measurement
Save

Periodic Timer Period	0.02
Periodic Timer Sync Source	None
Periodic Timer Trigger Delay	1.00 E-06
Periodic Timer Trigger Delay State	FALS E
PowerReferen ce	- 73.6 966
PSDReferenc e	- 139. 54
Radio Device	Bts
RFBurst Trigger Delay	1.00 E-06
RFBurst Trigger Delay State	FALS E
RFBurst Trigger Level Abs	-20
RFBurst Trigger Level Rel	-6
RFBurst Trigger Level Type	Absol ute
RFBurst Trigger Slope	Posit ive
RrcFilter	FALS E
SemAverageN umber	10
SemAverageS tate	FALS E
TotalAtten	10
Trigger Holdoff	0.1
Trigger	FALS

Holdoff State	E											
TriggerSource	Free											
Video Trigger Delay	1.00 E-06											
Video Trigger Delay State	FALS E											
Video Trigger Level	-25											
Video Trigger Slope	Positive											
Video Selection	AbsP wrFr eq											
MeasResult1	Meas Resul t2	Meas Resul t3	Meas Resul t4	MeasResu lt5	Meas Resul t6	Meas Resul t7	Meas Resul t8	Meas Resul t9	Meas Result 10	Meas Result 11	Meas Result 12	
-999	- 78.8 935 9	-13	999	- 73.6966 3340998 79	-999	-999	-999	-999	-999	-999	-999	
- 73.6966334 099879	- 78.9 523 5	-13	999	-999	-999	-999	-999	-999	-999	-999		

Capture Buffer

This function allows you to store captured data for reuse in demod measurements using 'Save/Recall' functionality for 'Capture Buffer'. (This function is enabled for 'Code Domain' and 'Modulation Accuracy' measurements ONLY)

'Capture Buffer' is saved and loaded as IQ Data with properties which show Sample Rate, Length, IF BW, etc.

Use-Case are as followings;

Use Capture Buffer to perform analysis of the same captured data using 'Code Domain' and 'Modulation Accuracy' measurements, or to playback previously saved captured data.

Key Path	Save, Data
Mode	CDMA2000
Example	MMEM:STOR:CAPT "MyCaptureData.bin" This stores the capture data in the file MyCaptureData.bin in the default directory.
Dependencies	Capture buffer functionality is only available for Code Domain and Modulation Accuracy measurement. In other measurements, this key is grayed out.

Initial S/W Revision	Prior to A.02.00
----------------------	------------------

Save As . . .

When you press “Save As”, the analyzer brings up a Windows dialog and a menu entitled “**Save As.**” This menu allows you to navigate to the various fields in the Windows dialog without using a keyboard or mouse. The Tab and Arrow keys can also be used for dialog navigation.

See "[To File . . .](#)" on page 2070 in Save, State for a full description of this dialog and menu.

The default path for saving files is:

For all of the Trace Data Files:

My Documents\<<mode name>\data\traces

For all of the Limit Data Files:

My Documents\<<mode name>\data\limits

For all of the Measurement Results Data Files:

My Documents\<<mode name>\data\<<measurement name>\results

For all of the Capture Buffer Data Files:

My Documents\<<mode name>\data\captureBuffer

Key Path	Save, Data
Mode	All
Notes	The key location is mode-dependent and will vary. Brings up the Save As dialog for saving a <mode specific> Save Type. The save is performed immediately and does not wait until the measurement is complete.
Initial S/W Revision	Prior to A.02.00

Screen Image

Pressing Screen Image accesses a menu of functions that enable you to specify a format and location for the saved screen image. It brings up a menu that allows you to specify the color scheme of the Screen Image (Themes) or navigate to the Save As dialog to perform the actual save.

Screen Image files contain an exact representation of the analyzer display. They cannot be loaded back onto the analyzer, but they can be loaded into your PC for use in many popular applications.

The image to be saved is actually captured when the Save front panel key is pressed, and kept in temporary storage to be used if you ask for a Screen Image save. When the Screen Image key is pressed, a "thumbnail" of the captured image is displayed, as shown below:

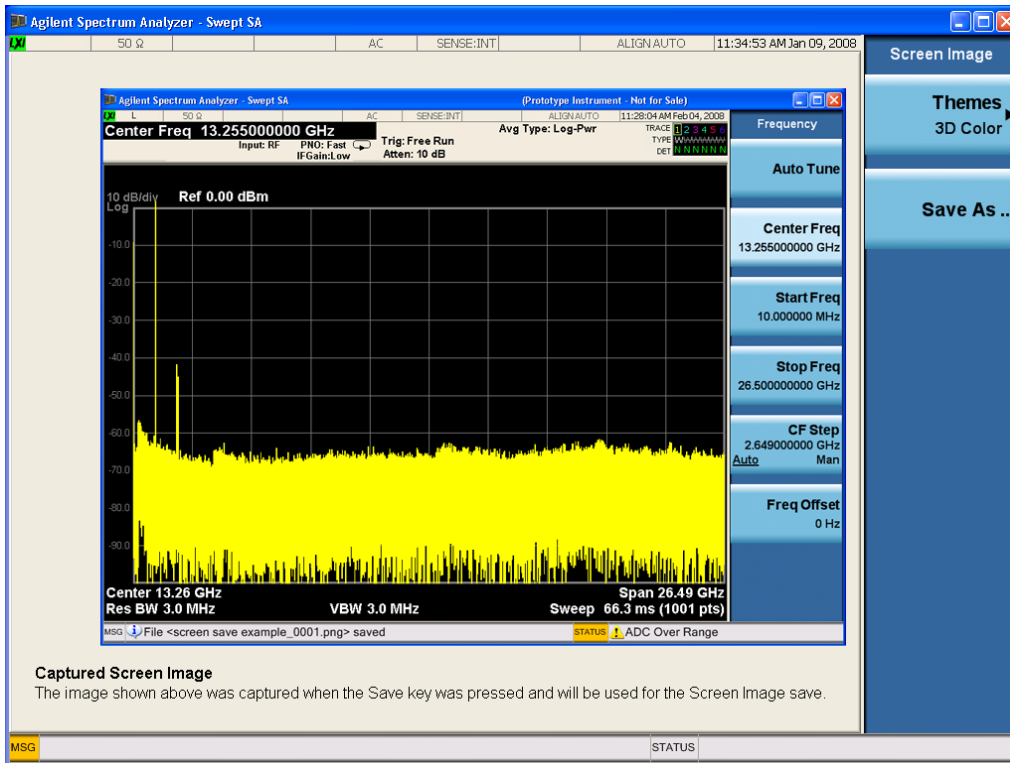

When you continue on into the Save As menu and complete the Screen Image save, the image depicted in the thumbnail is the one that gets saved, showing the menus that were on the screen before going into the Save menus. The save is performed immediately and does not wait until the measurement is complete.

After you have completed the save, the Quick Save front-panel key lets you quickly repeat the last save performed, using an auto-named file, with the current screen data.

NOTE For versions previous to A.01.55, if you initiate a screen image save by navigating through the Save menus, the image that is saved will contain the Save menu softkeys, not the menus and the active function that were on the screen when you first pressed the Save front panel key.

Key Path	Save
Mode	All
Remote Command	:MMEMory:STORe:SCREen <filename>
Example	:MMEM:STOR:SCR "myScreen.png" This stores the current screen image in the file MyScreenFile.png in the default directory.
Initial S/W Revision	Prior to A.02.00

Themes

Accesses a menu of functions that enable you to choose the theme to be used when saving the screen image.

The **Themes** option is the same as the **Themes** option under the **Display** and **Page Setup** dialogs. It allows you to choose between themes to be used when saving the screen image.

Key Path	Save, Screen Image
Remote Command	:MMEMory:STORe:SCReem:THEMe TDColor TDMonochrome FCOLor FMONochrome :MMEMory:STORe:SCReem:THEMe?
Example	:MMEM:STOR:SCR:THEM TDM
Preset	3D Color; Is not part of Preset, but is reset by Restore Misc Defaults or Restore System Defaults All and survives subsequent running of the modes.
Readback	3D Color 3D Mono Flat Color Flat Mono
Backwards Compatibility Notes	In ESA and PSA we offer the choice of "Reverse Bitmap" or "Reverse Metafile" when saving screen images. This is much like the "Flat Color" theme available in X-Series. Also, if you selected Reverse Bitmap AND a black & white screen image, that would be much like "Flat Monochrome". In other words, each of the X-Series themes has a similar screen image type in ESA/PSA. But they are not identical.
Initial S/W Revision	Prior to A.02.00

3D Color

Selects a standard color theme with each object filled, shaded and colored as designed.

Key Path	Save, Screen Image, Themes
Example	MMEM:STOR:SCR:THEM TDC
Readback	3D Color
Initial S/W Revision	Prior to A.02.00

3D Monochrome

Selects a format that is like 3D color but shades of gray are used instead of colors.

Key Path	Save, Screen Image, Themes
Example	MMEM:STOR:SCR:THEM TDM
Readback	3D Mono
Initial S/W Revision	Prior to A.02.00

Flat Color

Selects a format that is best when the screen is to be printed on an ink printer.

Key Path	Save, Screen Image, Themes
-----------------	----------------------------

Example	MMEM:STOR:SCR:THEM FCOL
Readback	Flat Color
Initial S/W Revision	Prior to A.02.00

Flat Monochrome

Selects a format that is like Flat Color. But only black is used (no colors, not even gray), and no fill.

Key Path	Save, Screen Image, Themes
Example	MMEM:STOR:SCR:THEM FMON
Readback	Flat Mono
Initial S/W Revision	Prior to A.02.00

Save As...

When you press "Save As", the analyzer brings up a Windows dialog and a menu entitled "**Save As.**" This menu allows you to navigate to the various fields in the Windows dialog without using a keyboard or mouse. The Tab and Arrow keys can also be used for dialog navigation.

See "[To File . . .](#)" on page 2070 in Save, State for a full description of this dialog and menu.

The default path for Screen Images is

My Documents\`<mode name>`\screen.

where `<mode name>` is the parameter used to select the mode with the INST:SEL command (for example, SA for the Spectrum Analyzer).

Key Path	Save, Screen Image
Notes	Brings up Save As dialog for saving a Screen Image Save Type
Initial S/W Revision	Prior to A.02.00

Single (Single Measurement/Sweep)

Sets the analyzer for Single measurement operation. The single/continuous state is Meas Global, so the setting will affect all the measurements. If you are Paused, pressing Single does a Resume.

See "[More Information](#)" on page 1030

Key Path	Front-panel key
Example	:INIT:CONT OFF
Notes	See Cont key description.
Backwards Compatibility Notes	<p>For Spectrum Analysis mode in ESA and PSA, the Single hardkey and the INITiate:IMM switched from continuous measurement to single measurement and restarted sweeps and averages (displayed average count reset to 1), but did not restart Max Hold and Min Hold. In the X-Series, the Single hardkey and the INITiate:IMM command initiate a sweep/ measurement/ average sequence/hold sequence including MaxHold and MinHold.</p> <p>For Spectrum Analysis mode in ESA and PSA, the Single hardkey restarted the sweep regardless of whether or not you were in an active sweep or sweep sequence. In the X-Series, Restart does this but Single only restarts the sweep or sweep sequence if you are in the idle state.</p> <p>INIT[:IMM] in ESA & PSA Spectrum Analysis Mode does an implied ABORT. In some other PSA Modes, INIT[:IMM] is ignored if not in the idle state. . The X-Series follows the ESA/PSA SA Mode model, which may cause some Modes to have compatibility problems.</p>
Initial S/W Revision	Prior to A.02.00

More Information

See "[Restart](#)" on page 2067 for details on the INIT:IMMEDIATE (Restart) function.

If you are already in single sweep, the INIT:CONT OFF command has no effect.

If you are already in Single Sweep, then pressing the Single key in the middle of a sweep does not restart the sweep or sequence. Similarly, pressing the Single key does not restart the sweep or sequence if the sweep is not in the idle state (for example, if you are taking a very slow sweep, or the analyzer is waiting for a trigger). Instead, it results in a message. "Already in Single, press Restart to initiate a new sweep or sequence". Even though pressing the Single key in the middle of a sweep does not restart the sweep, sending INIT:IMMEDIATE does reset it.

To take one more sweep without resetting the average count, increment the average count by 1, by pressing the step up key while **Average/Hold Number** is the active function, or sending the remote command CALC:AVER:TCON UP.

Source

Opens a menu of keys that access various source configuration menus and settings. In the test set, pressing this key also causes the central view area to change and display the Source Control Main view.

Key Path	Front-panel key
----------	-----------------

RF Output

This parameter sets the source RF power output state.

Key Path	Source
Remote Command	:OUTPut[:EXTernal][:STATe] ON OFF 1 0 :OUTPut[:EXTernal][:STATe]?
Example	OUTP OFF OUTP?
Notes	<p>The EXTERNAL node is shown in RD text so the SCPI remains the same between internal and external source control. However, for EXT we do not wish to document this node to the customer since we are controlling the internal source rather than the external source.</p> <p>This setting is for the independent mode and has no effect on the "List Sequencer" on page 2168. If the "Sequencer" on page 2168 is set to ON, the list sequencer controls the source output and this key will be grayed-out. And this setting will be none-forceful grey out on front panel to indicate out-of-scope. Non-forceful means user still can change this setting by SCPI but cannot change on front panel. When set to OFF will make source leave list sequencer and this setting will be black out and take effect immediately.</p> <p>When the RF Output is ON, an "RF" annunciator is displayed in the system settings panel. When the RF Output is turned Off, the RF annunciator is cleared. If the "Sequencer" on page 2168 is set to ON, the "RF" annunciator will be replaced by "SEQ" in the system settings panel, indicating that the output is controlled by the list sequencer.</p>
Preset	Off
Range	On Off
Initial S/W Revision	A.05.00

Amplitude

Allows you to access the Amplitude sub-menu.

Key Path	Source
Notes	<p>The sub-menu under this button is for independent mode and has no effect on "List Sequencer" on page 2168. If the "Sequencer" on page 2168 is set to ON, the list sequencer controls the source output and this key will be grayed-out on front panel to indicate out-of-scope. When you set "Sequencer" on page 2168 to Off will make source leave list sequencer and this button will be black out.</p>
Initial S/W Revision	A.05.00

RF Power

Allows you to adjust the power level of the source using the numeric keypad, step keys, or RPG. Pressing any digit, 0 through 9, on the numeric keypad brings up the unit terminator.

Please refer to the ["RF Power Range " on page 1033](#) table below for the valid ranges.

Key Path	Source, Amplitude
Remote Command	:SOURce:POWer[:LEVel][:IMMediate][:AMPLitude] <ampl> :SOURce:POWer[:LEVel][:IMMediate][:AMPLitude]?
Example	:SOUR:POW -100 dBm
Notes	<p>Amplitude corrections can be specified for use with the source. In the event of amplitude corrections being applied, the valid ranges for the RF power do not change dependant on the current amplitude correction setting. If the combination of RF power + amplitude correction is higher or lower than the source output range, the Source Unleveled bit is set and the "Source Unleveled" indicator will appear on status panel to indicate that the source cannot maintain the output power that has been requested.</p> <p>When signal generator is unable to maintain the requested output level, the "Source Unleveled" indicator will appear on status panel. When the source output setting is restored to the normal range, the "Source Unleveled" is removed from status panel.</p> <p>Internal source has list sequence mode, which comprises of several steps which contain separate output power, frequency and waveform etc. When the source list sequence playing is complete, the last step keeps playing, and user can use this command to change the list sequence last step's output power.</p> <p>The multiport adapter RFIO TX ports and GPS ports cannot ensure power accuracy when power setting is lower than -130dBm, this power setting value is defined by the sum of RF Power setting and related amplitude correction value. But user settable value could be lower than this limit. When application detected there exists power setting lower than -130dBm on MPA RFIO TX ports, then popup warning message . When application detected there exists power setting lower than -130dBm on MPA GPS ports, then popup warning message . This is only warning message, and check is performed when RF is ON.</p>
Notes	The Min and Max value here defined UI settable amplitude range. This range is larger than actual amplitude range with level accuracy defined in spec.
Dependencies	The RF power is dependent on the RF output port and frequency, such that the current frequency and selected output port determine the valid range of power values.
Preset	-100 dBm
Min	The range of values depends on the current frequency and selected RF output port. Please refer to the "RF Power Range " on page 1033 table below for the valid ranges.
Max	The range of values depends on the current frequency and selected RF output port. Please refer to the "RF Power Range " on page 1033 table below for the valid ranges.
Initial S/W Revision	A.05.00

All other models:

RF Power Range

RF Output Port	Frequency Range	Min Output Power	Max Output Power
High Power RF Out	10 MHz ≤ f ≤ 6 GHz	-150 dBm	20 dBm
RFIO 1 & RFIO 2	10 MHz ≤ f ≤ 6 GHz	-150 dBm	0 dBm
GPS (Note2)	10 MHz ≤ f ≤ 6 GHz	-150 dBm	0 dBm

Note: This is the UI power range, it's larger than actual spec.

Note2: GPS port is on the multiport adapter, or E6607C which has embedded MPA.

M9420A:

RF Power Range

RF Output Port	Frequency Range	Min Output Power	Max Output Power without Option "1EA"	Max Output Power with Option "1EA"
RF Output	60 MHz ≤ f ≤ 6 GHz	-150 dBm	10 dBm	18 dBm
RFHD	60 MHz ≤ f ≤ 6 GHz	-150 dBm	10 dBm	15 dBm
RFFD	60 MHz ≤ f ≤ 6 GHz	-150 dBm	0 dBm	0 dBm

Set Reference Power

This key allows you to set the power reference. Pressing this key turns the power reference state to ON, sets the reference power value to the current RF output power, maintains this power at the RF output, and sets the displayed power to 0.00 dB. All subsequent RF power values entered under Source>Amplitude>RF Power are interpreted as being relative to this reference power.

When you use a power reference, the signal generator outputs an RF power that is set relative to the reference power by the value entered under Source>Amplitude>RF Power as follows:

Output power = reference power – entered power

Where:

reference power equals the original RF Power entered under Source>Amplitude>RF Power and set as the reference power

entered power equals a new value entered under Source>Amplitude>Amptd Offset

In addition, the displayed power value is the same as a new value entered under Source>Amplitude>RF Power.

NOTE

If Power Ref is set to ON with a reference value set, entering a value under Source>Amplitude>RF Power and pressing Set Reference Power will add that value to the existing Power Ref value.

If you wish to change the reference power value to a new value entered under Source>Amplitude>RF Power, first you must set Power Ref to OFF and then press Set Reference Power.

Key Path	Source, Amplitude
Dependencies	This key is unavailable, and is grayed out when the "List Sequencer" on page 2168 is turned ON.
Initial S/W Revision	A.05.00

Power Ref

This key allows you to toggle the state of the power reference.

When you use a power reference, the signal generator outputs an RF power that is set relative to the reference power by the value entered under Source>Amplitude>RF Power as follows:

Output power = reference power + entered power

Where:

reference power equals the original RF Power entered under Source>Amplitude>RF Power and set as the reference power

entered power equals a new value entered under Source>Amplitude>Amptd Offset

For more information on Reference Frequency refer to ["Set Reference Power " on page 2099](#)

Key Path	Source, Amplitude
Remote Command	:SOURce:POWer:REFerence <ampl> :SOURce:POWer:REFerence? :SOURce:POWer:REFerence:STATe OFF ON 0 1 :SOURce:POWer:REFerence:STATe?
Example	:SOUR:POW:REF 0.00 dBm :SOUR:POW:REF:STATe ON
Dependencies	This setting is unavailable and is grayed out when the "List Sequencer" on page 2168 is turned ON.
Couplings	This value is coupled to the "Set Reference Power " on page 2099 key such that pressing the Set Reference Power key updates the reference power with the current output power.
Preset	0.00 dBm OFF
Min	-125.00 dBm
Max	10.00 dBm
Initial S/W Revision	A.05.00

Amptd Offset

Allows you to specify the RF output power offset value.

When the amplitude offset is set to zero (0) and you set a new offset value (positive or negative), the displayed amplitude value will change as follows and the RF output power will not change:

Displayed value = output power + offset value

Where:

output power equals the original RF Power entered under Source>Amplitude>RF Power

offset value equals the value entered under Source>Amplitude>Amptd Offset

When the amplitude offset is set to a value other than zero (0) and you enter a new RF power value under Source>Amplitude>RF Power, the displayed power will be the same as the value entered and the RF output power will be equal to the value entered minus the offset value as follows:

Output power = entered power – offset power

Displayed Power = output power + offset power

Displayed power = entered power

Where:

entered power equals the amplitude entered under Source>Amplitude>RF Power

offset power equals the value previously entered and set under Source>Amplitude>Amptd Offset

Key Path	Source, Amplitude
Remote Command	:SOURce:POWer[:LEVel][:IMMediate]:OFFSet <rel_ampl> :SOURce:POWer[:LEVel][:IMMediate]:OFFSet?
Example	:SOUR:POW:OFFS 0.00 dB
Dependencies	This setting is unavailable, and is grayed out when the List Sequencer is turned ON.
Preset	0.00 dB
Min	-200.00 dB
Max	200.00 dB
Initial S/W Revision	A.05.00

Modulation

Allows you to toggle the state of the modulation.

Key Path	Source
Remote Command	:OUTPut:MODulation[:STATe] ON OFF 1 0 :OUTPut:MODulation[:STATe]?
Example	:OUTP:MOD OFF
Notes	This setting is for independent mode and has no effect on " List Sequencer " on page 2168. If the " Sequencer " on page 2168 is set to ON, the list sequencer controls the source output and this key will be grayed-out. And this setting will be none-forceful grey out on front panel to indicate out-of-scope. Non-forceful means user still can change this setting by SCPI but cannot change manually on front panel. When set to Off will make source leave list sequencer and this setting will be black out and take effect immediately. When the Modulation is ON, the "MOD" annunciator is displayed in the system settings panel. When the Modulation is turned Off, the "MOD" annunciator is cleared. If the

	"Sequencer" on page 2168 is set to ON, the "MOD" annunciator will be replaced by "SEQ" in the system settings panel indicating that the output is controlled by list sequencer.
Preset	Off
Range	On Off
Initial S/W Revision	A.05.00

Frequency

Allows you to access the Frequency sub-menu.

Key Path	Source
Notes	The sub-menu under this button is for independent mode and has no effect on "List Sequencer" on page 2168. If the "Sequencer" on page 2168 is set to ON, the list sequencer controls the source output and this key will be grayed-out. And this button will be grey out on front panel to indicate out-of-scope. When set to Off will make source leave list sequencer and this button will be black out.
Initial S/W Revision	A.05.00

Frequency

Allows you to set the RF Output Frequency. You can adjust the frequency of the source using the numeric keypad, step keys, or RPG. Pressing any digit, 0 through 9, on the numeric keypad brings up the unit terminator.

Key Path	Source, Frequency
Remote Command	:SOURce:FREQuency[:CW] <freq> :SOURce:FREQuency[:CW]?
Example	:SOUR:FREQ 1.00 GHz
Notes	Internal source has list sequence mode, which comprises of several steps which contain separate output power, frequency and waveform etc. When the source list sequence playing is complete, the last step keeps playing, and user can use this command to change the list sequence last step's output frequency.
Couplings	The frequency value is coupled to the current channel band and number, such that updates to the band and number will update the frequency value to the corresponding absolute frequency.
Preset	1.00 GHz If license F1A or 5WC is present, the default Center Frequency should be 2.412GHz.
Min	10.00 MHz
Max	Hardware Dependant: Option 503 = 3.6 GHz Option 504 = 3.8 GHz Option 506 = 6.00 GHz For E6640A, if license 5WC is present, the frequency range should be limited to: 1.1GHz-1.7GHz,

2.4GHz–2.5GHz, 4.8GHz–6.0GHz. If the user-defined frequency is outside of range, UI will report an error message called "Settings conflict; Frequency is outside available range".

Initial S/W Revision A.05.00

Channel

The frequency of the source can be specified by a channel number of a given frequency band. This key allows you to specify the current channel number. For the appropriate range of channel numbers for a given frequency band, refer to the following tables: ["GSM/EDGE Channel Number Ranges" on page 1037](#), ["W-CDMA Channel Number Ranges" on page 1038](#), ["CDMA 2000 / 1xEVDO Channel Number Ranges" on page 1040](#), and ["LTE FDD Channel Number Ranges" on page 1042](#).

Key Path	Source, Frequency
Remote Command	:SOURce:FREQuency:CHANnels:NUMBer <int> :SOURce:FREQuency:CHANnels:NUMBer?
Example	:SOUR:FREQ:CHAN:NUMB 1
Notes	This key is grayed out when the "Radio Standard" on page 2111 is set to NONE. This key is grayed out on E6630A.
Dependencies	This key is grayed out when the "Radio Standard" on page 2111 is set to NONE. This key is grayed out on E6630A.
Couplings	The channel number is coupled to the frequency value when the "Radio Standard" on page 2111 is not set to NONE. When the frequency value is changed, the channel number will increase or decrease to match the new frequency. If the frequency is not at an exact match for a channel number, the nearest channel number is displayed along with a greater than or less than sign to indicate the frequency is above or below the channel number.
Preset	1
Min	Please refer to the tables below for the valid ranges.
Max	Please refer to the tables below for the valid ranges.
Initial S/W Revision	A.05.00

GSM/EDGE Channel Number Ranges

Band	Link (Device)	Range	Frequency (MHz)
P-GSM	Uplink (MS)	$1 \leq n \leq 124$	$890.0 + 0.2*n$
	Downlink (BS)	$1 \leq n \leq 124$	$935.0 + 0.2*n$
E-GSM	Uplink (MS)	$0 \leq n \leq 124$	$890.0 + 0.2*n$
		$975 \leq n \leq 1023$	$890.0 + 0.2*(n-1024)$
	Downlink (BS)	$0 \leq n \leq 124$	$935.0 + 0.2*n$
		$975 \leq n \leq 1023$	$935.0 + 0.2*(n-1024)$

Band	Link (Device)	Range	Frequency (MHz)
DCS 1800	Uplink (MS)	$512 \leq n \leq 885$	$1710.200 + 0.20*(n-512)$
	Downlink (BS)	$512 \leq n \leq 885$	$1805.200 + 0.20*(n-512)$
PCS 1900	Uplink (MS)	$512 \leq n \leq 810$	$1850.200 + 0.2*(n-512)$
	Downlink (BS)	$512 \leq n \leq 810$	$1930.200 + 0.2*(n-512)$
R-GSM	Uplink (MS)	$0 \leq n \leq 124$	$890.0 + 0.2*n$
		$955 \leq n \leq 1023$	$890.0 + 0.2*(n-1024)$
	Downlink (BS)	$0 \leq n \leq 124$	$935.0 + 0.2*n$
		$955 \leq n \leq 1023$	$935.0 + 0.2*(n-1024)$
GSM 450	Uplink (MS)	$256 \leq n \leq 293$	$450.6 + 0.2*(n-259)$
	Downlink (BS)	$256 \leq n \leq 293$	$460.6 + 0.2*(n-259)$
GSM 480	Uplink (MS)	$306 \leq n \leq 340$	$479.000 + 0.20*(n-306)$
	Downlink (BS)	$306 \leq n \leq 340$	$489.000 + 0.20*(n-306)$
GSM 850	Uplink (MS)	$128 \leq n \leq 251$	$824.200 + 0.20*(n-128)$
	Downlink (BS)	$128 \leq n \leq 251$	$869.200 + 0.20*(n-128)$
GSM 700	Uplink (MS)	$438 \leq n \leq 516$	$777.200 + 0.20*(n-438)$
	Downlink (BS)	$438 \leq n \leq 516$	$747.200 + 0.20*(n-438)$
T-GSM810	Uplink (MS)	$350 \leq n \leq 425$	$806.0 + 0.20*(n-350)$
	Downlink (BS)	$350 \leq n \leq 425$	$851.0 + 0.20*(n-350)$

W-CDMA Channel Number Ranges

Band	Link (Device)	Range	Frequency (MHz)
Band I	Downlink	$10562 \leq n \leq 10838$	$n \div 5$
	Uplink	$9612 \leq n \leq 9888$	$n \div 5$
Band II	Downlink	$412 \leq n \leq 687$	$n \div 5 + 1850.1$
		$9662 \leq n \leq 9938$	$n \div 5$
	Uplink	$12 \leq n \leq 287$	$n \div 5 + 1850.1$
		$350 \leq n \leq 425$	$n \div 5$
Band III	Downlink	$1162 \leq n \leq 1513$	$n \div 5 + 1575$
	Uplink	$937 \leq n \leq 1288$	$n \div 5 + 1525$
Band IV	Downlink	$537 \leq n \leq 1738$	$n \div 5 + 1805$
		$1887 \leq n \leq 2087$	$n \div 5 + 1735.1$
	Uplink	$1312 \leq n \leq 1513$	$n \div 5 + 1450$
		$1662 \leq n \leq 1862$	$n \div 5 + 1380.1$
Band V	Downlink	$1007 \leq n \leq 1087$	$n \div 5 + 670.1$
		$4357 \leq n \leq 4458$	$n \div 5$

Band	Link (Device)	Range	Frequency (MHz)
	Uplink	$782 \leq n \leq 862$	$n \div 5 + 670.1$
		$4132 \leq n \leq 4233$	$n \div 5$
Band VI	Downlink	$1037 \leq n \leq 1062$	$n \div 5 + 670.1$
		$4387 \leq n \leq 4413$	$n \div 5$
	Uplink	$812 \leq n \leq 837$	$n \div 5 + 670.1$
		$4162 \leq n \leq 4188$	$n \div 5$
Band VII	Downlink	$2237 \leq n \leq 2563$	$n \div 5 + 2175$
		$2587 \leq n \leq 2912$	$n \div 5 + 2105.1$
	Uplink	$2012 \leq n \leq 2338$	$n \div 5 + 2100$
		$2362 \leq n \leq 2687$	$n \div 5 + 2030.1$
Band VIII	Downlink	$2937 \leq n \leq 3088$	$n \div 5 + 340$
	Uplink	$2712 \leq n \leq 2863$	$n \div 5 + 340$
Band IX	Downlink	$9237 \leq n \leq 9387$	$n \div 5$
	Uplink	$8762 \leq n \leq 8912$	$n \div 5$
Band X	Downlink	$3112 \leq n \leq 3388$	$n \div 5 + 1490$
		$3412 \leq n \leq 3687$	$n \div 5 + 1430.1$
	Uplink	$2887 \leq n \leq 3163$	$n \div 5 + 1135$
		$3187 \leq n \leq 3462$	$n \div 5 + 1075.1$
Band XI	Downlink	$3712 \leq n \leq 3812$	$n \div 5 + 736$
	Uplink	$3487 \leq n \leq 3587$	$n \div 5 + 733$
Band XII	Downlink	$3837 \leq n \leq 3903$	$n \div 5 - 37$
		$3927 \leq n \leq 3992$	$n \div 5 - 54.9$
	Uplink	$3612 \leq n \leq 3678$	$n \div 5 - 22$
		$3702 \leq n \leq 3767$	$n \div 5 - 39.9$
Band XIII	Downlink	$4017 \leq n \leq 4043$	$n \div 5 - 55$
		$4067 \leq n \leq 4092$	$n \div 5 - 64.9$
	Uplink	$3792 \leq n \leq 3818$	$n \div 5 + 21$
		$3702 \leq n \leq 3767$	$n \div 5 - 39.9$
Band XIV	Downlink	$4117 \leq n \leq 4143$	$n \div 5 - 63$
		$4167 \leq n \leq 4192$	$n \div 5 - 72.9$
	Uplink	$3892 \leq n \leq 3918$	$n \div 5 + 12$
		$3942 \leq n \leq 3967$	$n \div 5 + 2.1$
Band XIX	Downlink	$712 \leq n \leq 763$	$n \div 5 + 735$
		$787 \leq n \leq 837$	$n \div 5 + 720.1$
	Uplink	$312 \leq n \leq 363$	$n \div 5 + 770$
		$387 \leq n \leq 437$	$n \div 5 + 755.1$

CDMA 2000 / 1xEVDO Channel Number Ranges

Band	Link (Device)	Range	Frequency (MHz)
US Cellular	Uplink (MS, reverse link)	$1 \leq N \leq 799$	$0.030 \times N + 825.000$
		$991 \leq N \leq 1023$	$0.030 \times (N - 1023) + 825.000$
		$1024 \leq N \leq 1323$	$0.030 \times (N - 1024) + 815.040$
	Downlink (BS, forward link)	$1 \leq N \leq 799$	$0.030 \times N + 870.000$
		$991 \leq N \leq 1023$	$0.030 \times (N - 1023) + 870.000$
		$1024 \leq N \leq 1323$	$0.030 \times (N - 1024) + 860.040$
US PCS	Uplink (MS, reverse link)	$0 \leq N \leq 1199$	$1850.000 + 0.050 \times N$
	Downlink (BS, forward link)	$0 \leq N \leq 1199$	$1930.000 + 0.050 \times N$
Japan Cellular Band	Uplink (MS, reverse link)	$1 \leq N \leq 799$	$0.0125 \times (N + 915.000)$
		$801 \leq N \leq 1039$	$0.0125 \times (N - 800) + 898.000$
		$1041 \leq N \leq 1199$	$0.0125 \times (N - 1040) + 887.000$
		$1201 \leq N \leq 1600$	$0.0125 \times (N - 1200) + 893.000$
	Downlink (BS, forward link)	$1 \leq N \leq 799$	$0.0125 \times (N + 860.000)$
		$801 \leq N \leq 1039$	$0.0125 \times (N - 800) + 843.000$
		$1041 \leq N \leq 1199$	$0.0125 \times (N - 1040) + 832.000$
		$1201 \leq N \leq 1600$	$0.0125 \times (N - 1200) + 838.000$
Korean PCS Band	Uplink (MS, reverse link)	$0 \leq N \leq 599$	$0.050 \times N + 1750.000$
	Downlink (BS, forward link)	$0 \leq N \leq 599$	$0.050 \times N + 1840.000$
NMT-450 Band	Uplink (MS, reverse link)	$1 \leq N \leq 400$	$0.025 \times (N - 1) + 450.000$
		$472 \leq N \leq 871$	$0.025 \times (N - 472) + 410.000$
		$1039 \leq N \leq 1473$	$0.020 \times (N - 1024) + 451.010$
		$1536 \leq N \leq 1715$	$0.025 \times (N - 1536) + 479.000$
		$1792 \leq N \leq 2016$	$0.020 \times (N - 1792) + 479.000$
	Downlink (BS, forward link)	$1 \leq N \leq 400$	$0.025 \times (N - 1) + 460.000$
		$472 \leq N \leq 871$	$0.025 \times (N - 472) + 420.000$
		$1039 \leq N \leq 1473$	$0.020 \times (N - 1024) + 461.010$
		$1536 \leq N \leq 1715$	$0.025 \times (N - 1536) + 489.000$
		$1792 \leq N \leq 2016$	$0.020 \times (N - 1792) + 489.000$
IMT-2000 Band	Uplink (MS, reverse link)	$0 \leq N \leq 1199$	$1920.000 + 0.050 \times N$
	Downlink (BS, forward link)	$0 \leq N \leq 1199$	$2100.000 + 0.050 \times N$
Upper 700 MHz Band	Uplink (MS, reverse link)	$0 \leq N \leq 240$	$776.000 + 0.050 \times N$
	Downlink (BS, forward link)	$0 \leq N \leq 240$	$746.000 + 0.050 \times N$

Band	Link (Device)	Range	Frequency (MHz)
	forward link)		
Secondary 800 MHz Band	Uplink (MS, reverse link)	$0 \leq N \leq 719$ $720 \leq N \leq 919$	$0.025 \times N + 806.000$ $0.025 \times (N - 720) + 896.000$
	Downlink (BS, forward link)	$0 \leq N \leq 719$ $720 \leq N \leq 919$	$0.025 \times N + 851.000$ $0.025 \times (N - 720) + 935.000$
2.5 GHz IMT Extension	Uplink (MS, reverse link)	$0 \leq N \leq 1399$	$2500.000 + 0.050 \times N$
	Downlink (BS, forward link)	$0 \leq N \leq 1399$	$2620.000 + 0.050 \times N$
US PCS 1.9 GHz	Uplink (MS, reverse link)	$0 \leq N \leq 1299$	$1850.000 + 0.050 \times N$
	Downlink (BS, forward link)	$0 \leq N \leq 1299$	$1930.000 + 0.050 \times N$
AWS	Uplink (MS, reverse link)	$0 \leq N \leq 899$	$1710.000 + 0.050 \times N$
	Downlink (BS, forward link)	$0 \leq N \leq 899$	$2100.000 + 0.050 \times N$
US 2.5 GHz	Uplink (MS, reverse link)	$140 \leq N \leq 1459$	$2495.000 + 0.050 \times N$
	Downlink (BS, forward link)	$140 \leq N \leq 1459$	$2617.000 + 0.050 \times N$
700 Public Safety	Uplink (MS, reverse link)	$0 \leq N \leq 240$	$787.000 + 0.050 \times N$
	Downlink (BS, forward link)	$0 \leq N \leq 240$	$757.000 + 0.050 \times N$
C2K Lower 700	Uplink (MS, reverse link)	$0 \leq N \leq 360$	$698.000 + 0.050 \times N$
	Downlink (BS, forward link)	$0 \leq N \leq 360$	$728.000 + 0.050 \times N$
400 Euro PAMR	Uplink (MS, reverse link)	$1 \leq N \leq 400$	$0.025 \times (N - 1) + 450.000$
		$472 \leq N \leq 871$	$0.025 \times (N - 472) + 410.000$
	Uplink (MS, reverse link)	$1536 \leq N \leq 1715$	$0.025 \times (N - 1536) + 479.000$
	Uplink (MS, reverse link)		
	Downlink (BS, forward link)	$1 \leq N \leq 400$	$0.025 \times (N - 1) + 460.000$
		$472 \leq N \leq 871$	$0.025 \times (N - 472) + 420.000$
	Downlink (BS, forward link)	$1536 \leq N \leq 1715$	$0.025 \times (N - 1536) + 489.000$
	Downlink (BS, forward link)		

Band	Link (Device)	Range	Frequency (MHz)
800 PAMR	Uplink (MS, reverse link)	$0 \leq N \leq 239$	$870.0125 + 0.025 \times N$
	Downlink (BS, forward link)	$0 \leq N \leq 239$	$915.0125 + 0.025 \times N$

LTE FDD Channel Number Ranges

The carrier frequency in the uplink and downlink is designated by the E-UTRA Absolute Radio Frequency Channel Number (EARFCN) in the range 0 – 65535. The relation between EARFCN and the carrier frequency in MHz for the downlink is given by the following equation, where FDL_low and NOffs-DL are given in table 5.4.4-1 and NDL is the downlink EARFCN.

$$FDL = FDL_low + 0.1(NDL - NOffs-DL)$$

The relation between EARFCN and the carrier frequency in MHz for the uplink is given by the following equation where FUL_low and NOffs-UL are given in table 5.4.4-1 and NUL is the uplink EARFCN.

$$FUL = FUL_low + 0.1(NUL - NOffs-UL)$$

Band	Downlink		Uplink			
	FDL_low (MHz)	NOffs-DL	Range of NDL	FUL_low (MHz)	NOffs-UL	Range of NUL
1		2110	0	0 - 599	1920	18000 - 18599
2		1930	600	600 - 1199	1850	18600 - 19199
3		1805	1200	1200 - 1949	1710	19200 - 19949
4		2110	1950	1950 - 2399	1710	19950 - 20399
5		869	2400	2400 - 2649	824	20400 - 20649
6		875	2650	2650 - 2749	830	20650 - 20749
7		2620	2750	2750 - 3449	2500	20750 - 20449
8		925	3450	3450 - 3799	880	21450 - 21799
9		1844.9	3800	3800 - 4149	1749.9	21800 - 22149
10		2110	4150	4150 - 4749	1710	22150 - 22749
11		1475.9	4750	4750 - 4949	1427.9	22750 - 22949

Band	Downlink	Uplink				
12	729	5010	5010 - 5179	699	23010	23010 - 23179
13	746	5180	5180 - 5279	777	23180	23180 - 23279
14	758	5280	5280 - 5379	788	23280	23280 - 23379
...						
17	734	5730	5730 - 5849	704	23730	23730 - 23849
18	860	5850	5850 - 5999	815	23850	23850 - 23999
19	875	6000	6000 - 6149	830	24000	24000 - 24149
20	791	6150	6150 - 6449	832	24150	24150 - 24449
21	1495.9	6450	6450 - 6599	1447.9	24450	24450 - 24599
...						
24	1525	7700	7700 - 8039	1626.5	25700	25700 - 26039
25	1930	8040	8040 - 8689	1850	26040	26040 - 26689
26	859	8690	8690 - 9039	814	26690	26690 - 27039
...						

Note: The channel numbers that designate carrier frequencies so close to the operating band edges that the carrier extends beyond the operating band edge shall not be used. This implies that the first 7, 15, 25, 50, 75 and 100 channel numbers at the lower operating band edge and the last 6, 14, 24, 49, 74 and 99 channel numbers at the upper operating band edge shall not be used for channel bandwidths of 1.4, 3, 5, 10, 15 and 20 MHz respectively.

LTE TDD Channel Number Ranges

The carrier frequency in the uplink and downlink is designated by the E-UTRA Absolute Radio Frequency Channel Number (EARFCN) in the range 0 – 65535. The relation between EARFCN and the carrier frequency in MHz for the downlink is given by the following equation, where FDL_low and NOffs-DL are given in table 5.4.4-1 and NDL is the downlink EARFCN.

$$FDL = FDL_low + 0.1(NDL - NOffs-DL)$$

The relation between EARFCN and the carrier frequency in MHz for the uplink is given by the following equation where FUL_low and NOffs-UL are given in table 5.4.4-1 and NUL is the uplink EARFCN.

$$FUL = FUL_low + 0.1(NUL - NOffs-UL)$$

Band	Downlink		Uplink			
	NOffs-DL	FDL_low (MHz)	Range of ND	FUL_low (MHz)	NOffs-UL	Range of NUL
33	1900		36000	36000 – 36199	1900	36000 – 36199
34	2010		36200	36200 – 36349	2010	36200 – 36349
35	1850		36350	36350 – 36949	1850	36350 – 36949
36	1930		36950	36950 – 37549	1930	36950 – 37549
37	1910		37550	37550 – 37749	1910	37550 – 37749
38	2570		37750	37750 – 38249	2570	37750 – 38249
39	1880		38250	38250 – 38649	1880	38250 – 38649
40	2300		38650	38650 – 39649	2300	38650 – 39649
41	2496		39650	39650 – 41589	2496	39650 – 41589
42	3400		41590	41590 – 43589	3400	41590 – 43589
43	3600		43590	43590 – 45589	3600	43590 – 45589

Note: The channel numbers that designate carrier frequencies so close to the operating band edges that the carrier extends beyond the operating band edge shall not be used. This implies that the first 7, 15, 25, 50, 75 and 100 channel numbers at the lower operating band edge and the last 6, 14, 24, 49, 74 and 99 channel numbers at the upper operating band edge shall not be used for channel bandwidths of 1.4, 3, 5, 10, 15 and 20 MHz respectively.

TDSCDMA Channel Number Ranges

1.28 Mcps TDD Option

No TX-RX frequency separation is required as Time Division Duplex (TDD) is employed. Each subframe consists of 7 main timeslots where all main timeslots (at least the first one) before the single switching point are allocated DL and all main timeslots (at least the last one) after the single switching point are allocated UL.

The nominal channel spacing is 1.6 MHz, but this can be adjusted to optimise performance in a particular deployment scenario.

The carrier frequency is designated by the UTRA absolute radio frequency channel number (UARFCN). The value of the UARFCN in the IMT2000 band is defined in the general case as follows:

$$N_t = 5 * F \quad 0.0 \text{ MHz} \leq F \leq 3276.6 \text{ MHz}$$

where F is the carrier frequency in MHz

Additional channels applicable to operation in the frequency band defined in sub-clause 5.2(d) are defined via the following UARFCN definition:

$$N_t = 5 * (F - 2150.1 \text{ MHz}) / 2572.5 \text{ MHz} \leq F \leq 2617.5 \text{ MHz}$$

UARFCN

1.28 Mcps TDD Option

The following UARFCN range shall be supported for each band:

**Table: UTRA Absolute Radio
Frequency Channel Number 1.28
Mcps TDD Option**

Frequency Band	Frequency Range	UARFCN Uplink and Downlink transmission
For operation in frequency band as defined in subclause 5.2 (a)	1900–1920 MHz	9504 to 9596
	2010–2025 MHz	10054 to 10121
For operation in frequency band as defined in subclause 5.2 (b)	1850–1910 MHz	9254 to 9546
	1930–1990 MHz	9654 to 9946
For operation in frequency band as defined in subclause 5.2 (c)	1910–1930 MHz	9554 to 9646
For operation in frequency band as defined in subclause 5.2 (d)	2570–2620 MHz	12854 to 13096
For operation in frequency band as defined in subclause 5.2 (e)	2300–2400 MHz	11504 to 11996
For operation in frequency band as defined in subclause 5.2 (f)	1880–1920 MHz	9404 to 9596

Radio Setup

Allows access to the sub-menus for selecting the radio standard and associated radio band. You can also set a frequency reference and offset.

This menu is greyed out when on E6630A. Radio band settings for GSM, cdma2000, and so on -- most of which are not actually supported in E6630A, which has three narrow frequency bands. So band settings are grayed out.

Key Path	Source, Frequency
Initial S/W Revision	A.05.00

Radio Standard

Allows access to the channel band sub-menus to select the desired radio standard. When you have selected the radio standard, you can then set an active channel band. The radio standard and the active

channel band allow you to use channel numbers to set frequency automatically.

Key Path	Source, Frequency, Radio Setup
Remote Command	:SOURce:FREQuency:CHANnels:BAND NONE PGSM EGSM RGSM DCS1800 PCS1900 TGSM810 GSM450 GSM480 GSM700 GSM850 BANDI BANDII BANDIII BANDIV BANDV BANDVI BANDVII BANDVIII BANDIX BANDX BANDXI BANDXII BANDXIII BANDXIV BANDXIX USCELL USPCS JAPAN KOREAN NMT IMT2K UPPER SECOND PAMR400 PAMR800 IMTEXT PCS1DOT9G AWS US2DOT5G PUBLIC LOWER BAND1 BAND2 BAND3 BAND4 BAND5 BAND6 BAND7 BAND8 BAND10 BAND11 BAND12 BAND13 BAND14 BAND17 BAND18 BAND19 BAND20 BAND21 BAND24 BAND25 BAND26 BAND27 BAND28 BAND29 BAND30 BAND31 BAND33 BAND34 BAND35 BAND36 BAND37 BAND38 BAND39 BAND40 BAND41 BAND42 BAND43 BAND44 BANDA BANDB BANDC BANDD BANDE BANDE :SOURce:FREQuency:CHANnels:BAND?
Example	:SOUR:FREQ:CHAN:BAND PGSM
Notes	Set this setting to "NONE" will grey out "Channel" on page 2103 Channel
Initial S/W Revision	A.05.00

None

Selects no radio standard for use. When you have selected the radio standard to NONE, you cannot use channel numbers to set frequency automatically. You will need to set the frequency manually.

Key Path	Source, Frequency, Radio Setup, Radio Standard
Initial S/W Revision	A.05.00

GSM/EDGE

Sets GSM/EDGE as the radio standard for use and accesses the GSM/EDGE specific channel band sub-menus.

Key Path	Source, Frequency, Radio Setup, Radio Standard
Initial S/W Revision	A.05.00

P-GSM

Selects P-GSM as the active channel band.

Key Path	Source, Frequency, Radio Setup, Radio Standard, GSM/EDGE
Example	:SOUR:FREQ:CHAN:BAND PGSM
Initial S/W Revision	A.05.00

E-GSM

Selects E-GSM as the active channel band.

Key Path	Source, Frequency, Radio Setup, Radio Standard, GSM/EDGE
Example	:SOUR:FREQ:CHAN:BAND EGSM
Initial S/W Revision	A.05.00

R-GSM

Selects R-GSM as the active channel band.

Key Path	Source, Frequency, Radio Setup, Radio Standard, GSM/EDGE
Example	:SOUR:FREQ:CHAN:BAND RGSM
Initial S/W Revision	A.05.00

DCS 1800

Selects DCS 1800 as the active channel band.

Key Path	Source, Frequency, Radio Setup, Radio Standard, GSM/EDGE
Example	:SOUR:FREQ:CHAN:BAND DCS1800
Initial S/W Revision	A.05.00

PCS 1900

Selects PCS 1900 as the active channel band.

Key Path	Source, Frequency, Radio Setup, Radio Standard, GSM/EDGE
Example	:SOUR:FREQ:CHAN:BAND PCS1900
Initial S/W Revision	A.05.00

GSM 450

Selects GSM 450 as the active channel band.

Key Path	Source, Frequency, Radio Setup, Radio Standard, GSM/EDGE
Example	:SOUR:FREQ:CHAN:BAND GSM450
Initial S/W Revision	A.05.00

GSM 480

Selects GSM 480 as the active channel band.

Key Path	Source, Frequency, Radio Setup, Radio Standard, GSM/EDGE
Example	:SOUR:FREQ:CHAN:BAND GSM480
Initial S/W Revision	A.05.00

GSM 850

Selects GSM 850 as the active channel band.

Key Path	Source, Frequency, Radio Setup, Radio Standard, GSM/EDGE
Example	:SOUR:FREQ:CHAN:BAND GSM850
Initial S/W Revision	A.05.00

GSM 700

Selects GSM 700 as the active channel band.

Key Path	Source, Frequency, Radio Setup, Radio Standard, GSM/EDGE
Example	:SOUR:FREQ:CHAN:BAND GSM700
Initial S/W Revision	A.05.00

T-GSM 810

Selects T-GSM 810 as the active channel band.

Key Path	Source, Frequency, Radio Setup, Radio Standard, GSM/EDGE
Example	:SOUR:FREQ:CHAN:BAND T-GSM810
Initial S/W Revision	A.05.00

WCDMA

Sets WCDMA as the radio standard for use and accesses the W-CDMA specific channel band sub-menus.

Key Path	Source, Frequency, Radio Setup, Radio Standard
Initial S/W Revision	A.05.00

Band I

Selects Band I as the active channel band.

Key Path	Source, Frequency, Radio Setup, Radio Standard, WCDMA
Example	:SOUR:FREQ:CHAN:BAND BANDI
Initial S/W Revision	A.05.00

Band II

Selects Band II as the active channel band.

Key Path	Source, Frequency, Radio Setup, Radio Standard, WCDMA
Example	:SOUR:FREQ:CHAN:BAND BANDII
Initial S/W Revision	A.05.00

Band III

Selects Band III as the active channel band.

Key Path	Source, Frequency, Radio Setup, Radio Standard, WCDMA
Example	:SOUR:FREQ:CHAN:BAND BANDIII
Initial S/W Revision	A.05.00

Band IV

Selects Band IV as the active channel band.

Key Path	Source, Frequency, Radio Setup, Radio Standard, WCDMA
Example	:SOUR:FREQ:CHAN:BAND BANDIV
Initial S/W Revision	A.05.00

Band V

Selects Band V as the active channel band.

Key Path	Source, Frequency, Radio Setup, Radio Standard, WCDMA
Example	:SOUR:FREQ:CHAN:BAND BANDV
Initial S/W Revision	A.05.00

Band VI

Selects Band VI as the active channel band.

Key Path	Source, Frequency, Radio Setup, Radio Standard, WCDMA
Example	:SOUR:FREQ:CHAN:BAND BANDVI
Initial S/W Revision	A.05.00

Band VII

Selects Band VII as the active channel band.

Key Path	Source, Frequency, Radio Setup, Radio Standard, WCDMA
Example	:SOUR:FREQ:CHAN:BAND BANDVII
Initial S/W Revision	A.05.00

Band VIII

Selects Band VIII as the active channel band.

Key Path	Source, Frequency, Radio Setup, Radio Standard, WCDMA
Example	:SOUR:FREQ:CHAN:BAND BANDVIII
Initial S/W Revision	A.05.00

Band IX

Selects Band IX as the active channel band.

Key Path	Source, Frequency, Radio Setup, Radio Standard, WCDMA
Example	:SOUR:FREQ:CHAN:BAND BANDIX
Initial S/W Revision	A.05.00

Band X

Selects Band X as the active channel band.

Key Path	Source, Frequency, Radio Setup, Radio Standard, WCDMA
Example	:SOUR:FREQ:CHAN:BAND BANDX
Initial S/W Revision	A.05.00

Band XI

Selects Band XI as the active channel band.

Key Path	Source, Frequency, Radio Setup, Radio Standard, WCDMA
Example	:SOUR:FREQ:CHAN:BAND BANDXI
Initial S/W Revision	A.05.00

Band XII

Selects Band XII as the active channel band.

Key Path	Source, Frequency, Radio Setup, Radio Standard, WCDMA
Example	:SOUR:FREQ:CHAN:BAND BANDXII
Initial S/W Revision	A.05.00

Band XIII

Selects band XIII as the active channel band.

Key Path	Source, Frequency, Radio Setup, Radio Standard, WCDMA
Example	:SOUR:FREQ:CHAN:BAND BANDXIII
Initial S/W Revision	A.05.00

Band XIV

Selects Band XIV as the active channel band.

Key Path	Source, Frequency, Radio Setup, Radio Standard, WCDMA
Example	:SOUR:FREQ:CHAN:BAND BANDXIV
Initial S/W Revision	A.05.00

LTE

Sets LTE FDD as the radio standard for use and accesses the LTE FDD specific channel band sub-menus..

Key Path	Source, Frequency, Radio Setup, Radio Standard
Initial S/W Revision	A.09.50

BAND 1

Selects BAND 1 as the band for the current step.

Key Path	Source, Frequency, Radio Setup, Radio Standard, LTE
----------	---

Example	:SOUR:FREQ:CHAN:BAND BAND1
Initial S/W Revision	A.09.50

BAND 2

Selects BAND 2 as the band for the current step.

Key Path	Source, Frequency, Radio Setup, Radio Standard, LTE
Example	:SOUR:FREQ:CHAN:BAND BAND2
Initial S/W Revision	A.09.50

BAND 3

Selects BAND 3 as the band for the current step.

Key Path	Source, Frequency, Radio Setup, Radio Standard, LTE
Example	:SOUR:FREQ:CHAN:BAND BAND3
Initial S/W Revision	A.09.50

BAND 4

Selects BAND 4 as the band for the current step.

Key Path	Source, Frequency, Radio Setup, Radio Standard, LTE
Example	:SOUR:FREQ:CHAN:BAND BAND4
Initial S/W Revision	A.09.50

BAND 5

Selects BAND 5 as the band for the current step.

Key Path	Source, Frequency, Radio Setup, Radio Standard, LTE
Example	:SOUR:FREQ:CHAN:BAND BAND5
Initial S/W Revision	A.09.50

BAND 6

Selects BAND 6 as the band for the current step.

Key Path	Source, Frequency, Radio Setup, Radio Standard, LTE
----------	---

Example	:SOUR:FREQ:CHAN:BAND BAND6
Initial S/W Revision	A.09.50

BAND 7

Selects BAND 7 as the band for the current step.

Key Path	Source, Frequency, Radio Setup, Radio Standard, LTE
Example	:SOUR:FREQ:CHAN:BAND BAND7
Initial S/W Revision	A.09.50

BAND 8

Selects BAND 8 as the band for the current step.

Key Path	Source, Frequency, Radio Setup, Radio Standard, LTE
Example	:SOUR:FREQ:CHAN:BAND BAND8
Initial S/W Revision	A.09.50

BAND 9

Selects BAND 9 as the band for the current step.

Key Path	Source, Frequency, Radio Setup, Radio Standard, LTE
Example	:SOUR:FREQ:CHAN:BAND BAND9
Initial S/W Revision	A.09.50

BAND 10

Selects BAND 10 as the band for the current step.

Key Path	Source, Frequency, Radio Setup, Radio Standard, LTE
Example	:SOUR:FREQ:CHAN:BAND BAND10
Initial S/W Revision	A.09.50

BAND 11

Selects BAND 11 as the band for the current step.

Key Path	Source, Frequency, Radio Setup, Radio Standard, LTE
----------	---

Example	:SOUR:FREQ:CHAN:BAND BAND11
Initial S/W Revision	A.09.50

BAND 12

Selects BAND 12 as the band for the current step.

Key Path	Source, Frequency, Radio Setup, Radio Standard, LTE
Example	:SOUR:FREQ:CHAN:BAND BAND12
Initial S/W Revision	A.09.50

BAND 13

Selects BAND 13 as the band for the current step.

Key Path	Source, Frequency, Radio Setup, Radio Standard, LTE
Example	:SOUR:FREQ:CHAN:BAND BAND13
Initial S/W Revision	A.09.50

BAND 14

Selects BAND 14 as the band for the current step.

Key Path	Source, Frequency, Radio Setup, Radio Standard, LTE
Example	:SOUR:FREQ:CHAN:BAND BAND14
Initial S/W Revision	A.09.50

BAND 17

Selects BAND 17 as the band for the current step.

Key Path	Source, Frequency, Radio Setup, Radio Standard, LTE
Example	:SOUR:FREQ:CHAN:BAND BAND17
Initial S/W Revision	A.09.50

BAND 18

Selects BAND 18 as the band for the current step.

Key Path	Source, Frequency, Radio Setup, Radio Standard, LTE
----------	---

Example	:SOUR:FREQ:CHAN:BAND BAND18
Initial S/W Revision	A.09.50

BAND 19

Selects BAND 19 as the band for the current step.

Key Path	Source, Frequency, Radio Setup, Radio Standard, LTE
Example	:SOUR:FREQ:CHAN:BAND BAND19
Initial S/W Revision	A.09.50

BAND 20

Selects BAND 20 as the band for the current step.

Key Path	Source, Frequency, Radio Setup, Radio Standard, LTE
Example	:SOUR:FREQ:CHAN:BAND BAND20
Initial S/W Revision	A.09.50

BAND 21

Selects BAND 21 as the band for the current step.

Key Path	Source, Frequency, Radio Setup, Radio Standard, LTE
Example	:SOUR:FREQ:CHAN:BAND BAND21
Initial S/W Revision	A.09.50

BAND 24

Selects BAND 24 as the band for the current step.

Key Path	Source, Frequency, Radio Setup, Radio Standard, LTE
Example	:SOUR:FREQ:CHAN:BAND BAND24
Initial S/W Revision	A.09.50

BAND 25

Selects BAND 25 as the band for the current step.

Key Path	Source, Frequency, Radio Setup, Radio Standard, LTE
----------	---

Example	:SOUR:FREQ:CHAN:BAND BAND25
Initial S/W Revision	A.09.50

BAND 26

Selects BAND 26 as the band for the current step.

Key Path	Source, Frequency, Radio Setup, Radio Standard, LTE
Example	:SOUR:FREQ:CHAN:BAND BAND26
Initial S/W Revision	A.12.53

BAND 27

Selects BAND 27 as the band for the current step.

Key Path	Source, Frequency, Radio Setup, Radio Standard, LTE
Example	:SOUR:FREQ:CHAN:BAND BAND27
Initial S/W Revision	A.14.00

BAND 28

Selects BAND 28 as the band for the current step.

Key Path	Source, Frequency, Radio Setup, Radio Standard, LTE
Example	:SOUR:FREQ:CHAN:BAND BAND28
Initial S/W Revision	A.14.00

BAND 31

Selects BAND 31 as the band for the current step.

Key Path	Source, Frequency, Radio Setup, Radio Standard, LTE
Example	:SOUR:FREQ:CHAN:BAND BAND31
Initial S/W Revision	A.14.00

LTE TDD

Sets LTE TDD as the radio standard for use and accesses the LTE TDD specific channel band sub-menus..

Key Path	Source, Frequency, Radio Setup, Radio Standard
Initial S/W Revision	A.11.50

BAND 33

Selects BAND 33 as the band for the current step.

Key Path	Source, Frequency, Radio Setup, Radio Standard, LTE TDD
Example	:SOUR:FREQ:CHAN:BAND BAND33
Initial S/W Revision	A.11.50

BAND 34

Selects BAND 34 as the band for the current step.

Key Path	Source, Frequency, Radio Setup, Radio Standard, LTE TDD
Example	:SOUR:FREQ:CHAN:BAND BAND34
Initial S/W Revision	A.11.50

BAND 35

Selects BAND 35 as the band for the current step.

Key Path	Source, Frequency, Radio Setup, Radio Standard, LTE TDD
Example	:SOUR:FREQ:CHAN:BAND BAND35
Initial S/W Revision	A.11.50

BAND 36

Selects BAND 36 as the band for the current step.

Key Path	Source, Frequency, Radio Setup, Radio Standard, LTE TDD
Example	:SOUR:FREQ:CHAN:BAND BAND36
Initial S/W Revision	A.11.50

BAND 37

Selects BAND 37 as the band for the current step.

Key Path	Source, Frequency, Radio Setup, Radio Standard, LTE TDD
Example	:SOUR:FREQ:CHAN:BAND BAND37
Initial S/W Revision	A.11.50

BAND 38

Selects BAND 38 as the band for the current step.

Key Path	Source, Frequency, Radio Setup, Radio Standard, LTE TDD
Example	:SOUR:FREQ:CHAN:BAND BAND38
Initial S/W Revision	A.11.50

BAND 39

Selects BAND 39 as the band for the current step.

Key Path	Source, Frequency, Radio Setup, Radio Standard, LTE TDD
Example	:SOUR:FREQ:CHAN:BAND BAND39
Initial S/W Revision	A.11.50

BAND 40

Selects BAND 40 as the band for the current step.

Key Path	Source, Frequency, Radio Setup, Radio Standard, LTE TDD
Example	:SOUR:FREQ:CHAN:BAND BAND40
Initial S/W Revision	A.11.50

BAND 41

Selects BAND 41 as the band for the current step.

Key Path	Source, Frequency, Radio Setup, Radio Standard, LTE TDD
Example	:SOUR:FREQ:CHAN:BAND BAND41
Initial S/W Revision	A.11.50

BAND 42

Selects BAND 42 as the band for the current step.

Key Path	Source, Frequency, Radio Setup, Radio Standard, LTE TDD
Example	:SOUR:FREQ:CHAN:BAND BAND42
Initial S/W Revision	A.11.50

BAND 43

Selects BAND 43 as the band for the current step.

Key Path	Source, Frequency, Radio Setup, Radio Standard, LTE TDD
Example	:SOUR:FREQ:CHAN:BAND BAND43
Initial S/W Revision	A.11.50

BAND 44

Selects BAND 44 as the band for the current step.

Key Path	Source, Frequency, Radio Setup, Radio Standard, LTE TDD
Example	:SOUR:FREQ:CHAN:BAND BAND44
Initial S/W Revision	A.14.00

TDSCDMA

Sets TDSCDMA as the radio standard for use and accesses the TDSCDMA specific channel band sub-menus..

Key Path	Source, Frequency, Radio Setup, Radio Standard
Initial S/W Revision	A.11.50

BAND A

Selects BAND A as the band for the current step.

Key Path	Source, Frequency, Radio Setup, Radio Standard, TDSCDMA
Example	:SOUR:FREQ:CHAN:BAND BANDA
Initial S/W Revision	A.11.50

BAND B

Selects BAND B as the band for the current step.

Key Path	Source, Frequency, Radio Setup, Radio Standard, TDSCDMA
Example	:SOUR:FREQ:CHAN:BAND BANDB
Initial S/W Revision	A.11.50

BAND C

Selects BAND C as the band for the current step.

Key Path	Source, Frequency, Radio Setup, Radio Standard, TDSCDMA
Example	:SOUR:FREQ:CHAN:BAND BANDC
Initial S/W Revision	A.11.50

BAND D

Selects BAND D as the band for the current step.

Key Path	Source, Frequency, Radio Setup, Radio Standard, TDSCDMA
Example	:SOUR:FREQ:CHAN:BAND BANDD
Initial S/W Revision	A.11.50

BAND E

Selects BAND E as the band for the current step.

Key Path	Source, Frequency, Radio Setup, Radio Standard, TDSCDMA
Example	:SOUR:FREQ:CHAN:BAND BANDE
Initial S/W Revision	A.11.50

BAND F

Selects BAND F as the band for the current step.

Key Path	Source, Frequency, Radio Setup, Radio Standard, TDSCDMA
Example	:SOUR:FREQ:CHAN:BAND BANDF
Initial S/W Revision	A.11.50

Radio Band Link

Allows you to specify the channel band type as either uplink or downlink link direction. This value is used in conjunction with the channel band and channel number to determine the absolute frequency output by the source. When set to “Uplink”, the source will calculate the uplink frequency using an uplink formula together with the selected channel band and channel number . When set to “Downlink”, the source will calculate the downlink frequency using a downlink formula together with the selected channel band and channel number.

Key Path	Source, Frequency, Radio Setup
Remote Command	:SOURce:RADio:BAND:LINK DOWN UP :SOURce:RADio:BAND:LINK?

Example	:SOUR:RAD:BAND:LINK UP
Preset	DOWN
Range	DOWN UP
Backwards Compatibility SCPI	:SOURce:RADio:DEVIce BTS MS
	:SOURce:RADio:DEVIce?
Backwards Compatibility Notes	BTS maps to the Downlink frequency MS maps to the Uplink frequency
Initial S/W Revision	A.05.00

Set Reference Frequency

This key allows you to set the frequency reference. Pressing this key turns the frequency reference state to ON, sets the reference frequency value to the current frequency, maintains this frequency at the RF output, and sets the displayed frequency to 0.00 Hz. All subsequent frequencies entered under Source>Frequency>Frequency are interpreted as being relative to this reference frequency.

When you use a frequency reference, the signal generator outputs a frequency that is set relative to the reference frequency by the value entered under Source>Frequency>Frequency as follows:

Output frequency = reference frequency - entered frequency

Where:

reference frequency equals the original RF frequency entered under Source>Frequency>Frequency and set as the reference frequency

entered frequency equals a new value entered under Source>Frequency>Frequency

In addition, the displayed frequency value will be the same as the value entered under Source>Frequency>Frequency.

NOTE

If Freq Reference is set to ON with a reference value set, entering a value under Source>Frequency>Frequency and pressing Set Frequency Reference will add that value to the existing Freq Reference value.

If you wish to change the reference frequency value to the new value entered under Source>Frequency>Frequency, first you must set Freq Reference to OFF and then press Set Frequency Reference.

Key Path	Source, Frequency
Remote Command	:SOURce:FREQuency:REFerence:SET
Example	:SOUR:FREQ:REF:SET
Dependencies	This setting is unavailable, and is grayed out when the List Sequencer is turned ON.
Initial S/W Revision	A.05.00

Freq Reference

This key allows you to toggle the state of the frequency reference. When the frequency reference state is ON, an annunciator is displayed on the main source view to indicate this state to the user.

When you use a frequency reference, the signal generator outputs a frequency that is set relative to the reference frequency by the value entered under Source>Frequency>Frequency as follows:

Output frequency = reference frequency + entered frequency

Where:

reference frequency equals the original RF frequency entered under Source>Frequency>Frequency and set as the reference frequency

entered frequency equals a new value entered under Source>Frequency>Frequency

For more information on Reference Frequency refer to ["Set Reference Frequency" on page 2127](#)

Key Path	Source, Frequency
Remote Command	:SOURce:FREQuency:REFerence <freq> :SOURce:FREQuency:REFerence? :SOURce:FREQuency:REFerence:STATe OFF ON 0 1 :SOURce:FREQuency:REFerence:STATe?
Example	:SOUR:FREQ:REF 0.00 Hz :SOUR:FREQ:REF:STATe ON
Dependencies	This setting is unavailable, and is grayed out when the List Sequencer is turned ON.
Couplings	The frequency reference state is coupled to the frequency reference set immediate action. When the reference set immediate action key is pressed, or the SCPI command issued, it turns the frequency reference state ON.
Preset	0.00 Hz OFF
Min	0.00 Hz
Max	Hardware Dependant: Option 503 = 3.6 GHz Option 504 = 3.8 GHz Option 506 = 6.00 GHz
Initial S/W Revision	A.05.00

Freq Offset

Allows you to specify the frequency offset value. When the frequency offset state is ON, an annunciator is displayed on the main source view to indicate this state to the user.

When the frequency offset is set to zero (0) and you set a new offset value, the displayed frequency value will change as follows and the RF output frequency will not change:

Displayed value = output frequency + offset value

Where:

output frequency equals the original frequency entered under Source>Frequency>Frequency

offset value equals the value entered under Source>Frequency>Freq Offset

When the frequency offset is set to a value other than zero (0) and you enter a new frequency value under Source>Frequency>Frequency, the displayed frequency will be the same as the value entered and the RF output frequency will be equal to the value entered minus the offset value as follows:

Output frequency = entered frequency – offset frequency

Displayed frequency = output frequency + offset frequency

Displayed frequency = entered frequency

Where:

entered frequency equals the frequency entered under Source>Frequency>Frequency

offset frequency equals the value previously entered and set under Source>Frequency>Freq Offset

Key Path	Source, Frequency
Remote Command	:SOURce:FREQuency:OFFSet <freq> :SOURce:FREQuency:OFFSet?
Example	:SOUR:FREQ:OFFS 0 Hz
Dependencies	This setting is unavailable, and is grayed out when the List Sequencer is turned ON.
Preset	0 Hz
Min	-100.00 GHz
Max	100.00 GHz
Initial S/W Revision	A.05.00

Modulation Setup

Allows access to the menus for setting up the available modulation types: "ARB" on page 2143, "AM" on page 2164, "FM" on page 2165, and "PM" on page 2167.

Key Path	Source
Initial S/W Revision	A.05.00

ARB

Allows you access to the ARB sub-menus.

Key Path	Source, Modulation Setup
Initial S/W Revision	A.05.00

ARB

Allows you to toggle the state of the ARB function. When the ARB is On, a “MOD” annunciator is displayed in the system settings panel. When the ARB is turned Off, the MOD annunciator is cleared

Key Path	Source, Modulation Setup, ARB
Remote Command	:SOURce:RADio:ARB[:STATe] ON OFF 1 0 :SOURce:RADio:ARB[:STATe]?
Example	:SOUR:RAD:ARB OFF :SOUR:RAD:ARB?
Notes	If the ARB is ON, a user then loads or deletes another file to ARB memory, the playing waveform segment may not keep phase continuity during the ARB memory operation. The waveform will be replayed after the ARB operation is finished.
Dependencies	This setting is for independent mode and has no effect on 3.3.8 list sequencer mode. Setting "Sequencer" on page 2168 Sequencer to On will put source enter list sequencer mode, and even if ARB state is On, the ARB file will not be played. Setting "Sequencer" on page 2168 Sequencer to Off will make source leave list sequencer mode, and this setting will take effect immediately. The ARB can only be turned on when there is a waveform file selected for playback. On the GUI if no waveform is selected, this key is grayed out. If you send the SCPI command to turn the ARB on with no waveform selected for playback, the ARB state remains OFF and an error is generated. "- When you try to recall a certain set of states in which the selected waveform is not in ARB memory and the ARB state is On, errors are reported
Preset	Off
Range	On Off
Initial S/W Revision	A.05.00

Select Waveform

Allows you to access to the waveform selection sub-menus.

Pressing this key changes the central view area to show the Waveform File Selection view.

Key Path	Source, Modulation Setup, ARB
Initial S/W Revision	A.05.00

Select Waveform

Allows you to select a waveform sequence or segment for the dual ARB to play.

NOTE: Selecting a waveform file does not result in automatic adjustments to burst timing (to compensate for the presence or absence of a Multiport Adapter); that adjustment occurs only when a waveform is loaded to ARB memory. See "Load Segment to ARB Memory" for more information about this adjustment.

Key Path	Source, Modulation Setup, ARB, Select Waveform
Remote Command	:SOURce:RADio:ARB:WAVeform <string> :SOURce:RADio:ARB:WAVeform?
Example	:SOUR:RAD:ARB:WAV "test_waveform.bin"
Notes	<p>If intended waveform is not in the memory yet, then issuing this command by SCPI will invoke ARB loading operation first, which involves a delay of unpredictable length. So this command should be followed by the query *OPC?, which holds off subsequent commands until the loading operation is complete.</p> <p><string> - specifies the name of the waveform segment or waveform sequence to be played by the ARB.</p> <p>When in Sequence Analyzer mode, and Include Source is Yes, if the you attempt to play a waveform sequence but not all the required waveform segments are in the ARB playback memory, the application will reject the loading operation with an error is generated .</p> <p>When Include Source is No, if you attempt to play a waveform sequence but not all the required waveform segments are contained in the ARB playback memory, the application will attempt to load the required segments from either the default directory of the current directory. If the ARB memory does not have enough space for all the waveform segments to be loaded, an error is generated and none of the waveform segments is loaded.</p> <p>If the ARB is ON, and you attempt to play a waveform sequence but not all the waveform segments within the sequence could be found to be loaded into ARB memory, an error is generated. The selected waveform keeps the previous value and ARB state remains On.</p> <p>If you specify a waveform segment over SCPI but the waveform segment is not present within ARB playback memory and cannot be found for auto loading within the current directory or the default directory, an error is generated and the file selection remains unchanged.</p> <p>If you select a waveform for playback and the waveform requires a license that is not installed on the instrument, an error is generated. error is generated.</p> <p>If the ARB is ON and you load a file to ARB memory or delete a file from ARB memory, the playing waveform segment may not keep phase continuity during the ARB memory operation. The waveform will be replayed after the ARB operation is finished.</p>
Initial S/W Revision	A.05.00

Segments on Hard Disk

Allows you access to the sub-menus for loading waveform segments from the hard disk into ARB memory. The default directory is: D: varb.

Pressing this key changes the current view to the Waveform Management View.

Key Path	Source, Modulation Setup, ARB, Select Waveform
Initial S/W Revision	A.05.00

Load Segment To ARB Memory

Allows you to load the selected file into ARB memory. On the front panel you select the file for loading to the ARB memory by highlighting the desired file in the list. Using the SCPI command, you specify the file

name on the HDD.

“NVWFM” (none-volatile storage) MSUS (Mass Storage Unit Specifier) is supported in the memory subsystem because the ARB memory cannot be accessed directly. Therefore, files must be downloaded to the instrument hard disk and then loaded into the ARB memory. “NVWFM” MSUS will be mapped to the default directory D: VARB. The SCPI command supports using either “NVWFM” MSUS or specifying a full path. For more information, see Memory Subsystem (Remote Command Only).

If a file of the same name already exists within ARB memory, it is overwritten. If you wish to load two segments of the same name, you must rename one of the segments before loading it into ARB memory. To rename a segment, you can either use Windows File Explorer, or the :MMEMORY:COPY command.

NOTE: When a waveform file is loaded to ARB memory, burst timing adjustments are made automatically, based on whether or not a Multiport Adapter is connected to the test set and powered on. If the connection/power status of the Multiport Adapter is changed after a waveform file has been loaded, it needs to be loaded again.

Key Path	Source, Modulation Setup, ARB, Select Waveform, Segments on Hard Disk
Remote Command	:SOURCE:RADio:ARB:LOAD <string>
Example	:SOUR:RAD:ARB:LOAD "D: VARB\testwaveform.bin" or :SOUR:RAD:ARB:LOAD "NVWFM:testwaveform.bin"
Notes	<p>Because loading the file involves a delay of unpredictable length, this command should be followed by the query *OPC?, which holds off subsequent commands until the loading operating is complete.</p> <p><string> - specifies the path name of the file to load from the HDD into ARB memory. It could be a <full path + filename>, or <"NVWFM" MSUS + colon + filename>.</p> <p>When in Sequence Analyzer mode, and Include Source is Yes, an attempt to load a file to ARB memory will be rejected with an error.</p> <p>When Include Source is No and if there is insufficient free ARB memory to load the selected waveform, an error is generated. .</p> <p>If you specify a file over SCPI, but the file is not at the specified location, an error is generated.</p> <p>If you try to load a waveform file but the file contains less than 500 IQ samples, an error is generated.</p> <p>If you try to load a Signal Studio waveform "*.wfm" which contains invalid waveform header, an error is generated.</p> <p>If the ARB is ON when you load a file to ARB memory or delete a file from ARB memory, the playing waveform segment may not keep phase continuity during the ARB memory operation. The waveform will be replayed after the ARB operation is finished.</p> <p>ARB can be loaded into ARB memory even required licenses do not present on the instrument. In this case, a GUI only warning message -800, "Operation complete; Loaded <filename> successfully, but no license <required licenses> installed". User can install required licenses according to <required licenses> string to license it, or multi-pack license it.</p>
Initial S/W Revision	A.05.00

Load All To ARB Memory

Allows you to load all the segment files within the currently selected directory into ARB memory. If a file of the same name already exists within ARB memory, it is overwritten. If you wish to load two segments of the

same name, you must rename one of the segments before loading it into ARB memory. To rename a segment, you can either use Windows File Explorer, or the :MEMory:COpy command.

NOTE: When a waveform file is loaded to ARB memory, burst timing adjustments are made automatically, based on whether or not a Multiport Adapter is connected to the test set and powered on. If the connection/power status of the Multiport Adapter is changed after a waveform file has been loaded, it needs to be loaded again.

Key Path	Source, Modulation Setup, ARB, Select Waveform, Segments on Hard Disk
Remote Command	:SOURce:RADio:ARB:LOAD:ALL <string>
Example	:SOUR:RAD:ARB:LOAD:ALL "D: varb"
Notes	<p><string> - specifies the directory on the HDD to load the files into ARB memory from.</p> <p>When in Sequence Analyzer mode, and Include Source is Yes, an attempt to load all files from a directory to ARB memory is rejected with an error.</p> <p>When Include Source is No and there is insufficient free ARB memory to load all the waveforms, when the ARB memory is full, the copy ceases, and an error is generated.</p> <p>If you specify a directory over SCPI, but the directory does not exist, an error is generated.</p> <p>If the ARB is ON, a user then loads or deletes file to ARB memory, the playing waveform segment may not keep phase continuity during the ARB memory operation. The waveform will be replayed after the ARB operation is finished.</p>
Initial S/W Revision	A.05.00

Change Directory...

Allows you to change the currently selected directory on the hard disk. Pressing this key opens a standard windows change directory dialog allowing you to select the new directory of interest.

The current directory is used for manually loading waveform segments into ARB memory for playback, and as a search location for waveform segments that are required to be loaded into ARB memory for playback of a waveform sequence or a list sequence.

Key Path	Source, Modulation Setup, ARB, Select Waveform, Segments on Hard Disk
Notes	No remote command, SCPI front panel only.
Initial S/W Revision	A.05.00

Default Directory...

Allows you to change the default directory. It is used as a search location for waveform segments that are required to be loaded into ARB memory for playback of a waveform sequence, and as a search location for selecting waveforms using SCPI.

Key Path	Source, Modulation Setup, ARB, Select Waveform, Segments on Hard Disk
Remote Command	:SOURce:RADio:ARB:DEFault:DIRectory <string> :SOURce:RADio:ARB: DEFault:DIRectory?
Example	:SOUR:RAD:ARB:DEF:DIR "D:\ArbFiles"

	:SOUR:RAD:ARB:DEF:DIR?
State Saved	Persistent, survives a power cycle and a preset but not saved in the instrument state
Initial S/W Revision	A.05.00

Segments in ARB Memory

Allows you access to the sub-menus for managing the files within ARB memory.

Key Path	Source, Modulation Setup, ARB, Select Waveform
Initial S/W Revision	A.05.00

Delete Segment From ARB Mem

Allows you to remove a segment from ARB playback memory.

Key Path	Source, Modulation Setup, ARB, Select Waveform, Segments in ARB Memory
Remote Command	:SOURce:RADio:ARB:DELeTe <string>
Example	:SOUR:RAD:ARB:DEL "testwaveform.bin"
Notes	<p><string> - specifies the waveform to be deleted from the ARB playback memory.</p> <p>When in Sequence Analyzer mode and Include Source is Yes, an attempt to delete a file from ARB memory is rejected with an error.</p> <p>When Include Source is No and you specify a file that does not exist within ARB memory, an error is generated.</p> <p>It is possible to delete files from within the ARB memory when the ARB is ON. However, if you attempt to delete the file that is currently playing an error is generated.</p> <p>It is possible to delete a file from within the ARB memory when the sequencer state is ON and the file is not being used by the List Sequencer. If you attempt to delete a file which is being used by the list sequencer, an error is generated.</p> <p>When sequencer state is On, even if ARB state is On, the selected waveform will not be played. In this case, if the selected waveform is not used in List Sequence, it can be deleted and the ARB state is turned Off.</p> <p>If the ARB is ON and you load a file to ARB memory or delete a file from ARB memory, the playing waveform segment may not keep phase continuity during the ARB memory operation. The waveform will be replayed after the ARB operation is finished.</p>
Initial S/W Revision	A.05.00

Delete All From ARB Memory

Allows you to remove all segments from ARB playback memory.

Key Path	Source, Modulation Setup, ARB, Select Waveform, Segments in ARB Memory
----------	--

Remote Command	:SOURce:RADio:ARB:DELeTe:ALL
Example	:SOUR:RAD:ARB:DELeTe:ALL
Notes	<p>When in Sequence Analyzer mode and Include Source is Yes, an attempt to delete all files from ARB memory is rejected with an error.</p> <p>When Include Source is No and you attempt to delete all files from ARB memory when the ARB is currently playing a file, all files except the one playing are deleted and an error is generated.</p> <p>If you attempt to delete all files from ARB memory when there are waveform files used in "List Sequencer" on page 2168 and "Sequencer" on page 2168 state is ON, all files except the files currently being used in list sequencer are deleted, and an error is generated.</p> <p>If the ARB is ON and you load a file to ARB memory or delete a file from ARB memory, the playing waveform segment may not keep phase continuity during the ARB memory operation. The waveform will be replayed after the ARB operation is finished.</p>
Initial S/W Revision	A.05.00

ARB Setup

Allows access to the ARB setup sub-menus.

Key Path	Source, Modulation Setup, ARB
Initial S/W Revision	A.05.00

Sample Rate

Allows you to set the ARB waveform playback sample rate.

Key Path	Source, Modulation Setup, ARB, ARB Setup
Remote Command	:SOURce:RADio:ARB:SCLock:RATE <freq> :SOURce:RADio:ARB:SCLock:RATE?
Example	:SOUR:RAD:ARB:SCL:RATE 48.00 MHz
Notes	If there is a sample rate specified in the header of the waveform file, changing that sample rate is not recommended, as it may cause problems with burst timing.
Dependencies	When a new waveform is selected for playback the settings contained within the associated waveform header file are applied to the ARB. The sample rate is one of the values stored within the header file. If the newly selected waveform file has an associated header file, the sample rate is updated with the value from the header file. The sample rate will remain unchanged if the newly selected waveform does not have an associated header file.
Preset	125.00 MHz
Min	1.00 kHz
Max	125.00 MHz
Initial S/W Revision	A.05.00

Run-Time Scaling

Allows you to adjust the run-time scaling value. The run-time scaling value is applied in real-time while the waveform is playing.

Key Path	Source, Modulation Setup, ARB, ARB Setup
Remote Command	:SOURce:RADio:ARB:RSCaling <real> :SOURce:RADio:ARB:RSCaling?
Example	:SOUR:RAD:ARB:RSC 100.00
Notes	This setting cannot be set in E6640A/M9420A. Grey out on menu and the value is fixed at 70.00%.
Dependencies	When a new waveform is selected for playback the settings contained within the associated waveform header file are applied to the ARB. The run-time scaling is one of the values stored within the header file. If the newly selected waveform file has an associated header file, the run-time scaling is updated with the value from the header file. The run-time scaling will remain unchanged if the newly selected waveform does not have an associated header file.
Preset	70.00 %
Min	1.00 %
Max	100.00 %
Initial S/W Revision	A.05.00

Baseband Freq Offset

Allows you to adjust the value by which the baseband frequency is offset relative to the carrier.

Key Path	Source, Modulation Setup, ARB, ARB Setup
Remote Command	:SOURce:RADio:ARB:BASEband:FREQuency:OFFSet <freq> :SOURce:RADio:ARB:BASEband:FREQuency:OFFSet?
Example	:SOUR:RAD:ARB:BAS:FREQ:OFFS 0.00 Hz
Dependencies	When a new waveform is selected for playback the settings contained within the associated waveform header file are applied to the ARB. The baseband frequency offset is one of the values stored within the header file. If the newly selected waveform file has an associated header file, the baseband frequency offset is updated with the value from the header file. The baseband frequency offset will remain unchanged if the newly selected waveform does not have an associated header file.
Preset	0.00 Hz
Min	-50.00 MHz
Max	50.00 MHz
Initial S/W Revision	A.05.00

Edit RMS

Allows you to edit or calculate current RMS of selected waveform.

Key Path	Source, Modulation Setup, ARB, ARB Setup
Initial S/W Revision	A.14.50

Current RMS

Allows you to directly specify current RMS value used to playback currently selected waveform. Please note incorrect RMS value may cause inaccurate power output in E6640A/M9420A that is sensitive to RMS value.

This setting is also updated by RMS in waveform header or updated when invoking RMS calculation operation.

This setting can be saved to the header of currently selected waveform by invoking ["Save Setup To Header" on page 2164](#) "Save Setup To Header".

Key Path	Source, Modulation Setup, ARB, ARB Setup, Edit RMS
Remote Command	:SOURce:RADio:ARB:RMS <float> :SOURce:RADio:ARB:RMS?
Example	:SOUR:RAD:ARB:HEAD:RMS 0.7 :SOUR:RAD:ARB:HEAD:RMS?
Notes	Valid range is 0 to 1.414, values outside the range will be clipped to the closest boundary. Note this value does not affect "List Sequencer" on page 2168 Source List Sequencer that always uses RMS value resides in each ARB header. If want this value to take effect in list sequencer, use "Save Setup To Header" on page 2164 "Save Setup to Header" to save current RMS value to header first, then play the ARB in source list sequencer.
Dependencies	When a new waveform is selected for playback, this setting is updated by the RMS value defined in associated waveform header file. If selected waveform has no associated header file or header file does not specify RMS value, then instrument will try to calculate out one automatically. Calculating RMS can also update this setting.
Preset	0
Range	0 ~ 1.414
Initial S/W Revision	A.14.50

RMS Calculation Mode

Allows you to specify the mode to calculate the current RMS.

Key Path	Source, Modulation Setup, ARB, ARB Setup, Edit RMS
Remote Command	:SOURce:RADio:ARB:RMS:CALCulation:MODE AUTO M1 M2 M3 M4 :SOURce:RADio:ARB:RMS:CALCulation:MODE?
Example	:SOUR:RAD:ARB:RMS:CALC:MODE AUTO
Notes	If no waveform is selected, or selected waveform is waveform sequence, the key will grey out.

Preset	AUTO
Range	AUTO M1 M2 M3 M4
Initial S/W Revision	A.14.50

Auto

RMS will be calculated based on the whole sample range of current selected waveform.

Key Path	Source, Modulation Setup, ARB, ARB Setup, Edit RMS, Calculate RMS, RMS Calculation Mode
Example	:SOUR:RAD:ARB:RMS:CALC:MODE AUTO
Initial S/W Revision	A.14.50

Marker 1

Selects marker 1 to designate sample range used for RMS calculation.

Key Path	Source, Modulation Setup, ARB, ARB Setup, Edit RMS, Calculate RMS, RMS Calculation Mode , Marker
Example	:SOUR:RAD:ARB:RMS:CALC:MODE M1
Initial S/W Revision	A.14.50

Marker 2

Selects marker 2 to designate sample range used for RMS calculation.

Key Path	Source, Modulation Setup, ARB, ARB Setup, Edit RMS, Calculate RMS, RMS Calculation Mode , Marker
Example	:SOUR:RAD:ARB:RMS:CALC:MODE M2
Initial S/W Revision	A.14.50

Marker 3

Selects marker 3 to designate sample range used for RMS calculation.

Key Path	Source, Modulation Setup, ARB, ARB Setup, Edit RMS, Calculate RMS, RMS Calculation Mode , Marker
Example	:SOUR:RAD:ARB:RMS:CALC:MODE M3
Initial S/W Revision	A.14.50

Marker 4

Selects marker 4 to designate sample range used for RMS calculation.

Key Path	Source, Modulation Setup, ARB, ARB Setup, Edit RMS, Calculate RMS, RMS Calculation Mode , Marker
Example	:SOUR:RAD:ARB:RMS:CALC:MODE M4
Initial S/W Revision	A.14.50

Calculate RMS

Allows you to calculate current RMS based on mode selected. This will update ["Current RMS" on page 2137](#) Current RMS setting.

Key Path	Source, Modulation Setup, ARB, ARB Setup, Edit RMS, Calculate RMS
Remote Command	:SOURce:RADio:ARB:RMS:CALCulate
Example	:SOUR:RAD:ARB:RMS:CALC
Notes	<p>If no waveform is selected, invoking this operation will get error “-221 Setting conflict; No waveform is selected for RMS operation”.</p> <p>If no waveform is selected, or selected waveform is waveform sequence, the key will grey out.</p> <p>If selected waveform does not contain marker data, but "RMS Calculation Mode" on page 2137 “RMS Calculation Mode” is set to marker, under this circumstance, invoking calculation operation will get error “-221 Setting conflict; There is no marker for currently selected waveform, auto RMS calculation mode is used instead”, and "RMS Calculation Mode" on page 2137 “RMS Calculation Mode” will be coupled to “Auto” mode automatically.</p> <p>RMS calculation does not suit for waveform sequence. If selected waveform is waveform sequence file, invoking this operation will get error “-221 Setting conflict; RMS calculation does not apply to waveform sequence”. But users can still edit current RMS as play parameter, and can save current RMS to waveform sequence header for later use.</p>
Initial S/W Revision	A.14.50

Use Header RMS

Allows you to quickly set RMS in ARB header to ["Current RMS" on page 2137](#) Current RMS setting.

Key Path	Source, Modulation Setup, ARB, ARB Setup, Edit RMS,
Notes	<p>No remote command, front panel only.</p> <p>If no waveform is selected, the key will grey out.</p> <p>If no waveform is selected, invoking this operation will get error “-221 Setting conflict; No waveform is selected for RMS operation”.</p>
Initial S/W Revision	A.14.50

Trigger Type

Allows access to the trigger type sub-menus. The setting for trigger type determines the behavior of the waveform when it plays.

Key Path	Source, Modulation Setup, ARB
Remote Command	:SOURce:RADio:ARB:TRIGger:TYPE CONTInuous SINGLE SADVance :SOURce:RADio:ARB:TRIGger:TYPE?
Example	:SOUR:RAD:ARB:TRIG:TYPE CONT :SOUR:RAD:ARB:TRIG:TYPE?
Notes	Gated trigger type will be implemented at a later release
Preset	CONTInuous
Range	Continuous Single Seg Adv
Initial S/W Revision	A.05.00

Continuous

Sets the active trigger type to Continuous. If Continuous is already selected as the active trigger type, pressing this key allows access to the continuous trigger type setup menu. In Continuous trigger mode, the waveform repeats continuously.

Key Path	Source, Modulation Setup, ARB, Trigger Type
Remote Command	:SOURce:RADio:ARB:TRIGger:TYPE:CONTInuous[:TYPE] FREE TRIGger RESet :SOURce:RADio:ARB:TRIGger:TYPE:CONTInuous[:TYPE]?
Example	:SOUR:RAD:ARB:TRIG:TYPE:CONT FREE
Preset	FREE
Range	Free Run Trigger + Run Reset + Run
Initial S/W Revision	A.05.00

Free Run

Selects Free Run as the trigger response for the continuous trigger type. Free Run sets the waveform generator to play a waveform sequence or segment continuously, without waiting for a trigger. In this mode, the waveform generator does not respond to triggers.

Key Path	Source, Modulation Setup, ARB, Trigger Type, Continuous
Example	:SOUR:RAD:ARB:TRIG:TYPE:CONT FREE
Initial S/W Revision	A.05.00

Trigger + Run

Sets Trigger and Run as the trigger response for the continuous trigger type. Trigger and Run sets the waveform generator to play a waveform sequence or segment continuously when the first trigger is received, and to ignore any subsequent triggers.

Key Path	Source, Modulation Setup, ARB, Trigger Type, Continuous
Example	:SOUR:RAD:ARB:TRIG:TYPE:CONT TRIG
Initial S/W Revision	A.05.00

Reset + Run

Sets Reset and Run as the trigger response for the continuous trigger type. Reset and Run sets the waveform generator to play a waveform sequence or segment continuously when the first trigger is received. Subsequent triggers reset the waveform sequence or segment to the start, and then play it continuously.

Key Path	Source, Modulation Setup, ARB, Trigger Type, Continuous
Example	:SOUR:RAD:ARB:TRIG:TYPE:CONT RES
Initial S/W Revision	A.05.00

Single

Sets the active trigger type to Single. If Single is already selected as the active trigger type, pressing this key allows access to the single trigger type setup menu. In Single trigger mode, the waveform plays once.

Key Path	Source, Modulation Setup, ARB, Trigger Type
Remote Command	:SOURce:RADio:ARB:RETRigger ON OFF IMMEDIATE :SOURce:RADio:ARB:RETRigger?
Example	:SOUR:RAD:ARB:RETR OFF
Notes	ON: Buffered Trigger OFF: No Retrigger Immediate: Restart on Trigger This is defined as an enumerated SCPI command, with ON OFF being considered as enumerated types rather than Boolean. This means the query will return OFF instead of 0, and ON instead of 1.
Preset	ON
Range	No Retrigger Buffered Trigger Restart on Trigger
Initial S/W Revision	A.05.00

No Retrigger

Selects No Retrigger as the trigger response for single trigger type. No Retrigger sets the waveform generator to play a waveform sequence or segment once when a trigger is received. Any triggers then

received during playback are ignored.

Key Path	Source, Modulation Setup, ARB, Trigger Type, Single
Example	:SOUR:RAD:ARB:RETR OFF
Initial S/W Revision	A.05.00

Buffered Trigger

Selects Buffered Trigger as the trigger response for single trigger type. Buffered Trigger sets the waveform generator to play a waveform sequence or segment once when a trigger is received. If a trigger is received during playback, the waveform generator plays the sequence or segment to the end, then plays the sequence or segment once more.

Key Path	Source, Modulation Setup, ARB, Trigger Type, Single
Example	:SOUR:RAD:ARB:RETR ON
Initial S/W Revision	A.05.00

Restart on Trigger

Selects Restart on Trigger as the trigger response for single trigger type. Restart on Trigger sets the waveform generator to play a waveform sequence or segment once when a trigger is received. If a trigger is received during playback, the waveform generator resets and plays the sequence or segment from the start.

Key Path	Source, Modulation Setup, ARB, Trigger Type, Single
Example	:SOUR:RAD:ARB:RETR IMM
Initial S/W Revision	A.05.00

Segment Advance

Sets the active trigger type to Segment Advance. If Segment Advance is already selected as the active trigger type, pressing this key allows access to the segment advance trigger type setup menu.

Segment Advance triggering allows you to control the playback of waveform segments within a waveform sequence. When a trigger is received the ARB advances to the next waveform segment within the waveform sequence. This type of triggering ignores the repetition count for the waveform segment within the waveform sequence. For example, if a waveform segment has a repetition count of 10 and you select single segment advance triggering mode, the waveform segment will only play once.

Segment Advance triggering can also be used for waveform segments only. In this situation the same waveform segment is played again when a trigger is received.

Key Path	Source, Modulation Setup, ARB, Trigger Type
Remote Command	:SOURce:RADio:ARB:TRIGger:TYPE:SADVance[:TYPE] SINGLE CONTinuous

	:SOURce:RADio:ARB:TRIGger:TYPE:SADVance[:TYPE]?
Example	:SOUR:RAD:ARB:TRIG:TYPE:SADV SING
Preset	CONTInuous
Range	Single Continuous
Initial S/W Revision	A.05.00

Single

Selects Single as the trigger response for Segment Advance trigger type. With single selected, once a trigger is received a segment is played once. If a trigger is received during playback of a segment, the segment plays to completion and the next segment is played once.

Key Path	Source, Modulation Setup, ARB, Trigger Type, Segment Advance
Example	:SOUR:RAD:ARB:TRIG:TYPE:SADV SING
Initial S/W Revision	A.05.00

Continuous

Selects Continuous as the trigger response for Segment Advance trigger type. With continuous selected, once a trigger is received a segment is played continuously. When subsequent triggers are received, the currently playing segment plays to completion and then the next segment is played continuously.

Key Path	Source, Modulation Setup, ARB, Trigger Type, Segment Advance
Example	:SOUR:RAD:ARB:TRIG:TYPE:SADV CONT
Initial S/W Revision	A.05.00

ARB

Allows you access to the ARB sub-menus.

Key Path	Source, Modulation Setup
Initial S/W Revision	A.05.00

Trigger Source

The trigger source setting determines how the source receives the trigger that starts the waveform playing. Therefore, this key is grayed out if the trigger type is free run, since free run triggers immediately with no trigger source required.

Key Path	Source, Modulation Setup, ARB
Remote Command	:SOURce:RADio:ARB:TRIGger[:SOURce] KEY BUS EXTernal2

	:SOURce:RADio:ARB:TRIGger[:SOURce]?
Example	:SOUR:RAD:ARB:TRIGger KEY
Dependencies	This key is grayed out if the current trigger type is Continuous, Free Run.
Preset	EXTernal2
Range	Trigger Key Bus External 2
Initial S/W Revision	A.05.00

Trigger Key

Sets the current trigger source to the front panel Trigger key. When Trigger Key is selected, the waveform is triggered when you press the front panel Trigger key.

Key Path	Source, Modulation Setup, ARB, Trigger Source
Example	:SOUR:RAD:ARB:TRIGger KEY
Initial S/W Revision	A.05.00

Bus

Sets the current trigger source to Bus. Selecting Bus trigger source enables triggering over GPIB, LAN, or USB using the :SOURce:RADio:ARB:TRIGger:INITiate command.

Key Path	Source, Modulation Setup, ARB, Trigger Source
Example	:SOUR:RAD:ARB:TRIGger BUS
Initial S/W Revision	A.05.00

External 2

Sets the current trigger source to External 2. Selecting External 2 enables triggering a waveform by an externally applied signal.

Key Path	Source, Modulation Setup, ARB, Trigger Source
Example	:SOUR:RAD:ARB:TRIGger EXT2
Notes	Note: When on E6640A, trigger 2 is a bi-directional trigger port. So when trigger 2 has been configured as OUTPUT type, choosing External 2 as the input trigger for the current step will generate error.
Initial S/W Revision	A.05.00

External Trigger Delay

This key allows you to toggle the state and value of external trigger delay. The value you enter sets a delay time between when an external trigger is received and when it is applied to the waveform. This is key is

active only if you select external trigger as trigger source.

Key Path	Source, Modulation Setup, ARB, Trigger Source
Remote Command	:SOURce:RADio:ARB:TRIGger[:SOURce]:EXTernal:DELay <time> :SOURce:RADio:ARB:TRIGger[:SOURce]:EXTernal:DELay? SOURce:RADio:ARB:TRIGger[:SOURce]:EXTernal:DELay:STATe OFF ON 0 1 :SOURce:RADio:ARB:TRIGger[:SOURce]:EXTernal:DELay:STATe?
Example	:SOUR:RAD:ARB:TRIG:EXT:DEL 100ns :SOUR:RAD:ARB:TRIG:EXT:DEL? :SOUR:RAD:ARB:TRIG:EXT:DEL:STAT ON :SOUR:RAD:ARB:TRIG:EXT:DEL:STAT?
Notes	External trigger delay time set by users will be rounded to the nearest integer multiple of the resolution.
Dependencies	This setting is unavailable and is grayed out when the Trigger Source is not set to external trigger.
Preset	1 ms OFF
Min	0 s
Max	8.589934588 s (Note: This value comes from $4\text{ns} * (2^{31} - 1) = 8589934588\text{ ns}$)
Initial S/W Revision	A.14.50

Trigger Initiate

Used to initiate an immediate trigger event if the trigger source is set to Trigger Key.

Key Path	Source, Modulation Setup, ARB
Notes	No remote command, SCPI front panel only.
Initial S/W Revision	A.05.00

Waveform Sequences

Allows access to the waveform sequence sub-menus. Pressing this key changes the central view area to display the Waveform Sequence List view.

Key Path	Source, Modulation Setup, ARB
Notes	No remote command, SCPI front panel only.
Initial S/W Revision	A.05.00

Build New Sequence

Allows access to the sub-menus for creating a new waveform sequence. Pressing this key changes the central view area to display the Waveform Sequence Creation and Editing view.

Key Path	Source, Modulation Setup, ARB, Waveform Sequences
Notes	No remote command, SCPI front panel only.
Initial S/W Revision	A.05.00

Current Segment

Specifies the selected sequence segment that will be affected by the menu functions.

Key Path	Source, Modulation Setup , ARB, Waveform Sequences, Build New Sequence
Notes	No remote command, SCPI front panel only. This key is grayed out and unavailable if the sequence is currently empty.
Initial S/W Revision	A.05.00

Insert New Waveform

Allows you access to the sub-menu for inserting a new waveform segment or sequence. Pressing this key also changes the central display to show the Waveform File Selection View.

Key Path	Source, Modulation Setup, ARB, Waveform Sequences, Build New Sequence
Notes	No remote command, SCPI front panel only. Waveform segment name string length upper limit is 128 chars. Please do NOT insert waveform which name string exceeds 128 chars.
Initial S/W Revision	A.05.00

Insert Waveform

Inserts the currently highlighted waveform to the end of the waveform sequence. Pressing this key also returns you to the menus for creating or editing a sequence, and returns the central view to the sequence creation view.

Key Path	Source, Modulation Setup, ARB, Waveform Sequences, Build New Sequence, Insert New Waveform
Notes	No remote command, SCPI front panel only. Waveform segment name string length upper limit is 128 chars. Please do NOT insert waveform which name string exceeds 128 chars.
Initial S/W Revision	A.05.00

Segments on Hard Disk

Allows you access to the sub-menus for loading waveform segments from the hard disk into ARB memory. The default directory is: D: varb.

Pressing this key changes the current view to the Waveform Management View.

Key Path	Source, Modulation Setup, ARB, Select Waveform
Initial S/W Revision	A.05.00

Load Segment To ARB Memory

Allows you to load the selected file into ARB memory. On the front panel you select the file for loading to the ARB memory by highlighting the desired file in the list. Using the SCPI command, you specify the file name on the HDD.

“NVWFM” (none-volatile storage) MSUS (Mass Storage Unit Specifier) is supported in the memory subsystem because the ARB memory cannot be accessed directly. Therefore, files must be downloaded to the instrument hard disk and then loaded into the ARB memory. “NVWFM” MSUS will be mapped to the default directory D: VARB. The SCPI command supports using either “NVWFM” MSUS or specifying a full path. For more information, see Memory Subsystem (Remote Command Only).

If a file of the same name already exists within ARB memory, it is overwritten. If you wish to load two segments of the same name, you must rename one of the segments before loading it into ARB memory. To rename a segment, you can either use Windows File Explorer, or the :MMEMory:COPI command.

NOTE: When a waveform file is loaded to ARB memory, burst timing adjustments are made automatically, based on whether or not a Multiport Adapter is connected to the test set and powered on. If the connection/power status of the Multiport Adapter is changed after a waveform file has been loaded, it needs to be loaded again.

Key Path	Source, Modulation Setup, ARB, Select Waveform, Segments on Hard Disk
Remote Command	:SOURce:RADio:ARB:LOAD <string>
Example	:SOUR:RAD:ARB:LOAD “D: VARB\testwaveform.bin” or :SOUR:RAD:ARB:LOAD “NVWFM:testwaveform.bin”
Notes	<p>Because loading the file involves a delay of unpredictable length, this command should be followed by the query *OPC?, which holds off subsequent commands until the loading operating is complete.</p> <p><string> – specifies the path name of the file to load from the HDD into ARB memory. It could be a <full path + filename>, or <“NVWFM” MSUS + colon + filename>.</p> <p>When in Sequence Analyzer mode, and Include Source is Yes, an attempt to load a file to ARB memory will be rejected with an error.</p> <p>When Include Source is No and if there is insufficient free ARB memory to load the selected waveform, an error is generated. .</p> <p>If you specify a file over SCPI, but the file is not at the specified location, an error is generated.</p> <p>If you try to load a waveform file but the file contains less than 500 IQ samples, an error is generated.</p> <p>If you try to load a Signal Studio waveform “*.wfm” which contains invalid waveform header, an error is generated.</p>

If the ARB is ON when you load a file to ARB memory or delete a file from ARB memory, the playing waveform segment may not keep phase continuity during the ARB memory operation. The waveform will be replayed after the ARB operation is finished.

ARB can be loaded into ARB memory even if required licenses do not present on the instrument. In this case, a GUI only warning message -800, "Operation complete; Loaded <filename> successfully, but no license <required licenses> installed". User can install required licenses according to <required licenses> string to license it, or multi-pack license it.

Initial S/W Revision	A.05.00
----------------------	---------

Load All To ARB Memory

Allows you to load all the segment files within the currently selected directory into ARB memory. If a file of the same name already exists within ARB memory, it is overwritten. If you wish to load two segments of the same name, you must rename one of the segments before loading it into ARB memory. To rename a segment, you can either use Windows File Explorer, or the :MEMory:COpy command.

NOTE: When a waveform file is loaded to ARB memory, burst timing adjustments are made automatically, based on whether or not a Multiport Adapter is connected to the test set and powered on. If the connection/power status of the Multiport Adapter is changed after a waveform file has been loaded, it needs to be loaded again.

Key Path	Source, Modulation Setup, ARB, Select Waveform, Segments on Hard Disk
----------	---

Remote Command	:SOURce:RADio:ARB:LOAD:ALL <string>
----------------	-------------------------------------

Example	:SOUR:RAD:ARB:LOAD:ALL "D: varb"
---------	----------------------------------

Notes	<p><string> - specifies the directory on the HDD to load the files into ARB memory from.</p> <p>When in Sequence Analyzer mode, and Include Source is Yes, an attempt to load all files from a directory to ARB memory is rejected with an error.</p> <p>When Include Source is No and there is insufficient free ARB memory to load all the waveforms, when the ARB memory is full, the copy ceases, and an error is generated.</p> <p>If you specify a directory over SCPI, but the directory does not exist, an error is generated.</p> <p>If the ARB is ON, a user then loads or deletes file to ARB memory, the playing waveform segment may not keep phase continuity during the ARB memory operation. The waveform will be replayed after the ARB operation is finished.</p>
-------	---

Initial S/W Revision	A.05.00
----------------------	---------

Change Directory...

Allows you to change the currently selected directory on the hard disk. Pressing this key opens a standard windows change directory dialog allowing you to select the new directory of interest.

The current directory is used for manually loading waveform segments into ARB memory for playback, and as a search location for waveform segments that are required to be loaded into ARB memory for playback of a waveform sequence or a list sequence.

Key Path	Source, Modulation Setup, ARB, Select Waveform, Segments on Hard Disk
Notes	No remote command, SCPI front panel only.
Initial S/W Revision	A.05.00

Default Directory...

Allows you to change the default directory. It is used as a search location for waveform segments that are required to be loaded into ARB memory for playback of a waveform sequence, and as a search location for selecting waveforms using SCPI.

Key Path	Source, Modulation Setup, ARB, Select Waveform, Segments on Hard Disk
Remote Command	:SOURce:RADio:ARB:DEFault:DIRectory <string> :SOURce:RADio:ARB: DEFault:DIRectory?
Example	:SOUR:RAD:ARB:DEF:DIR "D:\ArbFiles" :SOUR:RAD:ARB:DEF:DIR?
State Saved	Persistent, survives a power cycle and a preset but not saved in the instrument state
Initial S/W Revision	A.05.00

Segments in ARB Memory

Allows you access to the sub-menus for managing the files within ARB memory.

Key Path	Source, Modulation Setup, ARB, Select Waveform
Initial S/W Revision	A.05.00

Delete Segment From ARB Mem

Allows you to remove a segment from ARB playback memory.

Key Path	Source, Modulation Setup, ARB, Select Waveform, Segments in ARB Memory
Remote Command	:SOURce:RADio:ARB:DELete <string>
Example	:SOUR:RAD:ARB:DEL "testwaveform.bin"
Notes	<string> - specifies the waveform to be deleted from the ARB playback memory. When in Sequence Analyzer mode and Include Source is Yes, an attempt to delete a file from ARB memory is rejected with an error. When Include Source is No and you specify a file that does not exist within ARB memory, an error is generated. It is possible to delete files from within the ARB memory when the ARB is ON. However, if you attempt to delete the file that is currently playing an error is generated. It is possible to delete a file from within the ARB memory when the sequencer state is ON and the file is not being used by the List Sequencer. If you attempt to delete a file which is being used by the list

sequencer, an error is generated.

When sequencer state is On, even if ARB state is On, the selected waveform will not be played. In this case, if the selected waveform is not used in List Sequence, it can be deleted and the ARB state is turned Off.

If the ARB is ON and you load a file to ARB memory or delete a file from ARB memory, the playing waveform segment may not keep phase continuity during the ARB memory operation. The waveform will be replayed after the ARB operation is finished.

Initial S/W Revision	A.05.00
----------------------	---------

Delete All From ARB Memory

Allows you to remove all segments from ARB playback memory.

Key Path	Source, Modulation Setup, ARB, Select Waveform, Segments in ARB Memory
Remote Command	:SOURce:RADio:ARB:DELeTe:ALL
Example	:SOUR:RAD:ARB:DELeTe:ALL
Notes	<p>When in Sequence Analyzer mode and Include Source is Yes, an attempt to delete all files from ARB memory is rejected with an error.</p> <p>When Include Source is No and you attempt to delete all files from ARB memory when the ARB is currently playing a file, all files except the one playing are deleted and an error is generated.</p> <p>If you attempt to delete all files from ARB memory when there are waveform files used in "List Sequencer" on page 2168 and "Sequencer" on page 2168 state is ON, all files except the files currently being used in list sequencer are deleted, and an error is generated.</p> <p>If the ARB is ON and you load a file to ARB memory or delete a file from ARB memory, the playing waveform segment may not keep phase continuity during the ARB memory operation. The waveform will be replayed after the ARB operation is finished.</p>

Initial S/W Revision	A.05.00
----------------------	---------

Edit Selected Waveform

Allows access to the sub-menus for editing the details of the currently selected waveform segment.

Key Path	Source, Modulation Setup, ARB, Waveform Sequences, Build New Sequence
Notes	No remote command, front panel only.
Initial S/W Revision	A.05.00

Repetitions

Allows you to specify the number of times the currently selected waveform is played within the sequence.

Key Path	Source, Modulation Setup, ARB, Waveform Sequences, Build New Sequence, Edit Selected Waveform
----------	---

Notes	No remote command, SCPI front panel only.
Preset	1
Min	1
Max	65535
Initial S/W Revision	A.05.00

Marker 1

Allows you to enable or disable marker 1 for the currently selected waveform. For a waveform sequence, you can enable and disable markers on a per-segment basis, allowing you to output markers from some waveform segments within the sequence, but not for others.

Key Path	Source, Modulation Setup, ARB, Waveform Sequences, Build New Sequence, Edit Selected Waveform
Notes	No remote command, front panel only.
Preset	Enabled
Range	Enabled Disabled
Initial S/W Revision	A.05.00

Marker 2

Allows you to enable or disable marker 2 for the currently selected waveform. For a waveform sequence, you can enable and disable markers on a per-segment basis, allowing you to output markers from some waveform segments within the sequence, but not for others.

Key Path	Source, Modulation Setup, ARB, Waveform Sequences, Build New Sequence, Edit Selected Waveform
Notes	No remote command, front panel only.
Preset	Enabled
Range	Enabled Disabled
Initial S/W Revision	A.05.00

Marker 3

Allows you to enable or disable marker 3 for the currently selected waveform. For a waveform sequence, you can enable and disable markers on a per-segment basis, allowing you to output markers from some waveform segments within the sequence, but not for others.

Key Path	Source, Modulation Setup, ARB, Waveform Sequences, Build New Sequence, Edit Selected Waveform
----------	---

Notes	No remote command, front panel only.
Preset	Enabled
Range	Enabled Disabled
Initial S/W Revision	A.05.00

Marker 4

Allows you to enable or disable marker 4 for the currently selected waveform. For a waveform sequence, you can enable and disable markers on a per-segment basis, allowing you to output markers from some waveform segments within the sequence, but not for others.

Key Path	Source, Modulation Setup, ARB, Waveform Sequences, Build New Sequence, Edit Selected Waveform
Notes	No remote command, front panel only.
Preset	Enabled
Range	Enabled Disabled
Initial S/W Revision	A.05.00

Delete Segment

Allows you to delete the selected segment from the waveform sequence.

Key Path	Source, Modulation Setup, ARB, Waveform Sequences, Build New Sequence
Notes	No remote command, front panel only.
Initial S/W Revision	A.05.00

Save Sequence...

Pressing this key displays the “Save As” dialog. The sequence name is passed to the save as dialog to use as the filename for saving, and the directory the save as dialog will open into is the default waveform directory.

Key Path	Source, Modulation Setup, ARB, Waveform Sequences, Build New Sequence
Initial S/W Revision	A.05.00

Edit Selected Sequence

Allows access to the sub-menus for editing the sequence currently selected within the Waveform Sequence List view. Pressing this key changes the central view area to display the Waveform Sequence Creation and Editing view.

Key Path	Source, Modulation Setup, ARB, Waveform Sequences
Notes	No remote command, front panel only.
Initial S/W Revision	A.05.00

Current Directory...

Allows you to change the currently selected directory on the hard disk. Pressing this key opens a standard windows change directory dialog and allows you to select the new directory of interest.

Key Path	Source, Modulation Setup, ARB, Waveform Sequences
Notes	No remote command, front panel only.
Initial S/W Revision	A.05.00

Waveform Utilities

Allows you access to the waveform utilities sub-menus.

Key Path	Source, Modulation Setup, ARB
Initial S/W Revision	A.05.00

Multi-Pack Licenses

Allows you access to the Multi - Pack License sub-menus. Pressing this key also changes the central view area to display the Multi -Pack License Management view.

On modular instrument like E6630A or E6640A, multi-pack license operations are only allowed on the default module, i.e. “Left” module for E6630A or “TRX1” module for E6640A.

Key Path	Source, Modulation Setup, ARB, Waveform Utilities
Dependencies	This key is only available if there is at least one Multi-pack license installed on the instrument.
Initial S/W Revision	A.05.00

Add Waveform

Pressing this key accesses the Add Waveform sub-menu. It also changes the central display area to display the Multi-Pack License Waveform Add view.

Key Path	Source, Modulation Setup, ARB, Waveform Utilities, Multi-Pack Licenses
Dependencies	This key is only available if there is at least one slot available within at least one multi-pack license.
Initial S/W Revision	A.05.00

Add Waveform

Allows you to add the currently selected waveform segment to a multi-pack license. The new waveform is added to the next available slot regardless of which slot was selected on the Multi-Pack License Management view.

Key Path	Source, Modulation Setup, ARB, Waveform Utilities, Multi-Pack Licenses, Add Waveform
Remote Command	:SYSTem:LKEY:WAVeform:ADD <string> or :SYSTem:LICense[:FPACK]:WAVeform:ADD <string>
Example	SYST:LKEY:WAV:ADD "mywaveform.wfm" or SYST:LIC:WAV:ADD "mywaveform.wfm"
Notes	The second SCPI :SYSTem:LICense[:FPACK]:WAVeform:ADD is provided to be consistent with the style of Keysight signal sources. You can use either one of them. Since adding a waveform segment to a Multi-Pack license causes the license slot to enter the trial period of only 48 hours, pressing this key causes a confirmation dialog to be displayed to ensure you do want to add the waveform segment to the Multi-Pack. If you attempt to license a waveform that is already licensed using another slot an error is generated. .
Dependencies	This key is only available if the currently selected file is a secure waveform requiring a license, and there is at least one slot available within at least one multi-pack license. If the waveform highlighted is a secure waveform, but is already licensed, this key will be unavailable.
Initial S/W Revision	A.05.00

Segments on Hard Disk

Allows you access to the sub-menus for loading waveform segments from the hard disk into ARB memory. The default directory is: D: varb.

Pressing this key changes the current view to the Waveform Management View.

Key Path	Source, Modulation Setup, ARB, Select Waveform
Initial S/W Revision	A.05.00

Load Segment To ARB Memory

Allows you to load the selected file into ARB memory. On the front panel you select the file for loading to the ARB memory by highlighting the desired file in the list. Using the SCPI command, you specify the file name on the HDD.

"NVWFM" (none-volatile storage) MSUS (Mass Storage Unit Specifier) is supported in the memory subsystem because the ARB memory cannot be accessed directly. Therefore, files must be downloaded to the instrument hard disk and then loaded into the ARB memory. "NVWFM" MSUS will be mapped to the

default directory D: VARB. The SCPI command supports using either “NVWFM” MSUS or specifying a full path. For more information, see Memory Subsystem (Remote Command Only).

If a file of the same name already exists within ARB memory, it is overwritten. If you wish to load two segments of the same name, you must rename one of the segments before loading it into ARB memory. To rename a segment, you can either use Windows File Explorer, or the :MMEMory:COPY command.

NOTE: When a waveform file is loaded to ARB memory, burst timing adjustments are made automatically, based on whether or not a Multiport Adapter is connected to the test set and powered on. If the connection/power status of the Multiport Adapter is changed after a waveform file has been loaded, it needs to be loaded again.

Key Path	Source, Modulation Setup, ARB, Select Waveform, Segments on Hard Disk
Remote Command	:SOURce:RADio:ARB:LOAD <string>
Example	:SOUR:RAD:ARB:LOAD “D: VARB\testwaveform.bin” or :SOUR:RAD:ARB:LOAD “NVWFM:testwaveform.bin”
Notes	<p>Because loading the file involves a delay of unpredictable length, this command should be followed by the query *OPC?, which holds off subsequent commands until the loading operating is complete.</p> <p><string> – specifies the path name of the file to load from the HDD into ARB memory. It could be a <full path + filename>, or <“NVWFM” MSUS + colon + filename>.</p> <p>When in Sequence Analyzer mode, and Include Source is Yes, an attempt to load a file to ARB memory will be rejected with an error.</p> <p>When Include Source is Noand if there is insufficient free ARB memory to load the selected waveform, an error is generated. .</p> <p>If you specify a file over SCPI, but the file is not at the specified location, an error is generated.</p> <p>If you try to load a waveform file but the file contains less than 500 IQ sampes, an error is generated.</p> <p>If you try to load a Signal Studio waveform “*.wfm” which contains invalid waveform header, an error is generated.</p> <p>If the ARB is ON when you load afile to ARB memory or delete a file from ARB memory, the playing waveform segment may not keep phase continuity during the ARB memory operation. The waveform will be replayed after the ARB operation is finished.</p> <p>ARB can be loaded into ARB memory even required licenses do not present on the instrument. In this case, a GUI only warning message -800, “Operation complete; Loaded <filename> successfully, but no license <required licenses> installed”. User can install required licenses according to <required licenses> string to license it, or multi-pack license it.</p>
Initial S/W Revision	A.05.00

Load All To ARB Memory

Allows you to load all the segment files within the currently selected directory into ARB memory. If a file of the same name already exists within ARB memory, it is overwritten. If you wish to load two segments of the same name, you must rename one of the segments before loading it into ARB memory. To rename a segment, you can either use Windows File Explorer, or the :MEMory:COPY command.

NOTE: When a waveform file is loaded to ARB memory, burst timing adjustments are made automatically, based on whether or not a Multiport Adapter is connected to the test set and powered on. If the

connection/power status of the Multiport Adapter is changed after a waveform file has been loaded, it needs to be loaded again.

Key Path	Source, Modulation Setup, ARB, Select Waveform, Segments on Hard Disk
Remote Command	:SOURce:RADio:ARB:LOAD:ALL <string>
Example	:SOUR:RAD:ARB:LOAD:ALL "D: varb"
Notes	<p><string> - specifies the directory on the HDD to load the files into ARB memory from.</p> <p>When in Sequence Analyzer mode, and Include Source is Yes, an attempt to load all files from a directory to ARB memory is rejected with an error.</p> <p>When Include Source is No and there is insufficient free ARB memory to load all the waveforms, when the ARB memory is full, the copy ceases, and an error is generated.</p> <p>If you specify a directory over SCPI, but the directory does not exist, an error is generated.</p> <p>If the ARB is ON, a user then loads or deletes file to ARB memory, the playing waveform segment may not keep phase continuity during the ARB memory operation. The waveform will be replayed after the ARB operation is finished.</p>
Initial S/W Revision	A.05.00

Change Directory...

Allows you to change the currently selected directory on the hard disk. Pressing this key opens a standard windows change directory dialog allowing you to select the new directory of interest.

The current directory is used for manually loading waveform segments into ARB memory for playback, and as a search location for waveform segments that are required to be loaded into ARB memory for playback of a waveform sequence or a list sequence.

Key Path	Source, Modulation Setup, ARB, Select Waveform, Segments on Hard Disk
Notes	No remote command, SCPIfront panel only.
Initial S/W Revision	A.05.00

Default Directory...

Allows you to change the default directory. It is used as a search location for waveform segments that are required to be loaded into ARB memory for playback of a waveform sequence, and as a search location for selecting waveforms using SCPI.

Key Path	Source, Modulation Setup, ARB, Select Waveform, Segments on Hard Disk
Remote Command	:SOURce:RADio:ARB:DEFault:DIRectory <string> :SOURce:RADio:ARB: DEFault:DIRectory?
Example	:SOUR:RAD:ARB:DEF:DIR "D:\ArbFiles" :SOUR:RAD:ARB:DEF:DIR?
State Saved	Persistent, survives a power cycle and a preset but not saved in the instrument state
Initial S/W Revision	A.05.00

Replace Waveform

Pressing this key accesses the Replace Waveform submenu. It also changes the central display area to display the Multi-Pack License Waveform Add view.

Key Path	Source, Modulation Setup, ARB, Waveform Utilities, Multi-Pack Licenses
Dependencies	This key is only available if the currently selected slot is in the trial state.
Initial S/W Revision	A.05.00

Replace Waveform

Allows you to replace the waveform in the currently selected slot with the waveform currently selected in the Multi-Pack License Waveform Add view.

Key Path	Source, Modulation Setup, ARB, Waveform Utilities, Multi-Pack Licenses, Replace Waveform
Remote Command	:SYSTem:LKEY:WAVeform:REPLace <int>, <string> or :SYSTem:LICense[:FPACK]:WAVeform:REPLace <int>, <string>
Example	SYST:LKEY:WAV:REPL 1, "myotherwaveform.wfm" or :SYST:LIC:WAV:REPL 1, "myotherwaveform.wfm"
Notes	The second SCPI :SYSTem:LICense[:FPACK]:WAVeform:REPLace is provided to be consistent with the style of Keysight signal sources. You can use either one of them. If you attempt to license a waveform that is already licensed using another slot an error is generated. Waveform slot number <int> is positive. If you attempt to input a slot number less than or equals 0, an error is generated.
Initial S/W Revision	A.05.00

Clear Waveform from Slot

Allows you to clear the waveform from the selected slot.

Key Path	Source, Modulation Setup, ARB, Waveform Utilities, Multi-Pack Licenses
Remote Command	:SYSTem:LKEY:WAVeform:CLEar <int> or :SYSTem:LICense[:FPACK]:WAVeform:CLEar <int>
Example	SYST:LKEY:WAV:CLE 1 or :SYST:LIC:WAV:CLE 1
Notes	The second SCPI :SYSTem:LICense[:FPACK]:WAVeform:CLEar is provided to be consistent with the style of Keysight signal sources. You can use either one of them. Waveform slot number <int> is positive. If you attempt to input a slot number less than or equals 0, an error is generated.

error is generated.

Dependencies	This key is only available if the currently selected slot is in the trial state.
Initial S/W Revision	A.05.00

Lock Waveform in Slot

If the selected slot is in the trial state or the lock required state, the waveform that occupies the slot is locked and permanently licensed.

Key Path	Source, Modulation Setup, ARB, Waveform Utilities, Multi-Pack Licenses
Remote Command	:SYSTem:LKEY:WAVeform:LOCK <int> or :SYSTem:LICense[:FPACK]:WAVeform:LOCK <int>
Example	SYST:LKEY:WAV:LOCK 1 or SYST:LIC:WAV:LOCK 1
Notes	The second SCPI :SYSTem:LICense[:FPACK]:WAVeform:LOCK is provided to be consistent with the style of Keysight signal sources. You can use either one of them. Waveform slot number <int> is positive. If you attempt to input a slot number less than or equals 0, an error is generated.
Dependencies	This key is only available if the currently selected slot is in the trial state or the lock required state.
Initial S/W Revision	A.05.00

Marker Utilities

Allows access to the marker utilities sub-menus.

Key Path	Source, Modulation Setup, ARB
Initial S/W Revision	A.05.00

Marker Polarity

Allows access to the marker polarity sub-menu, which allows you to specify the polarity for the four markers. For a positive polarity, the marker signal is high during the marker points. For a negative marker polarity, the marker signal is high during the period of no marker points.

Key Path	Source, Modulation Setup, ARB, Marker Utilities
Initial S/W Revision	A.05.00

Mkr 1 Polarity

Allows you to set the polarity of marker 1.

Key Path	Source, Modulation Setup, ARB, Marker Utilities, Marker Polarity
Remote Command	:SOURce:RADio:ARB:MPOLarity:MARKer1 POSitive NEGative :SOURce:RADio:ARB:MPOLarity:MARKer1?
Example	:SOUR:RAD:ARB:MPOL:MARK1 NEG
Dependencies	When a new waveform is selected for playback the settings contained within the associated waveform header file are applied to the ARB. The marker polarity is one of the values stored within the header file. If the newly selected waveform file has an associated header file, the marker polarity is updated with the value from the header file. The marker polarity will remain unchanged if the newly selected waveform does not have an associated header file.
Preset	Pos
Range	Neg Pos
Initial S/W Revision	A.05.00

Mkr 2 Polarity

Allows you to set the polarity of marker 2.

Key Path	Source, Modulation Setup, ARB, Marker Utilities, Marker Polarity
Remote Command	:SOURce:RADio:ARB:MPOLarity:MARKer2 POSitive NEGative :SOURce:RADio:ARB:MPOLarity:MARKer2?
Example	:SOUR:RAD:ARB:MPOL:MARK2 NEG
Dependencies	When a new waveform is selected for playback the settings contained within the associated waveform header file are applied to the ARB. The marker polarity is one of the values stored within the header file. If the newly selected waveform file has an associated header file, the marker polarity is updated with the value from the header file. The marker polarity will remain unchanged if the newly selected waveform does not have an associated header file.
Preset	Pos
Range	Neg Pos
Initial S/W Revision	A.05.00

Mkr 3 Polarity

Allows you to set the polarity of marker 3.

Key Path	Source, Modulation Setup, ARB, Marker Utilities, Marker Polarity
Remote Command	:SOURce:RADio:ARB:MPOLarity:MARKer3 POSitive NEGative :SOURce:RADio:ARB:MPOLarity:MARKer3?
Example	:SOUR:RAD:ARB:MPOL:MARK3 NEG
Dependencies	When a new waveform is selected for playback the settings contained within the associated

	waveform header file are applied to the ARB. The marker polarity is one of the values stored within the header file. If the newly selected waveform file has an associated header file, the marker polarity is updated with the value from the header file. The marker polarity will remain unchanged if the newly selected waveform does not have an associated header file.
Preset	Pos
Range	Neg Pos
Initial S/W Revision	A.05.00

Mkr 4 Polarity

Allows you to set the polarity of marker 4.

Key Path	Source, Modulation Setup, ARB, Marker Utilities, Marker Polarity
Remote Command	:SOURce:RADio:ARB:MPOLarity:MARKer4 POSitive NEGative :SOURce:RADio:ARB:MPOLarity:MARKer4?
Example	:SOUR:RAD:ARB:MPOL:MARK4 NEG
Dependencies	When a new waveform is selected for playback the settings contained within the associated waveform header file are applied to the ARB. The marker polarity is one of the values stored within the header file. If the newly selected waveform file has an associated header file, the marker polarity is updated with the value from the header file. The marker polarity will remain unchanged if the newly selected waveform does not have an associated header file.
Preset	Pos
Range	Neg Pos
Initial S/W Revision	A.05.00

Marker Routing

Allows access to the marker routing sub-menus, which allow you to specify where the marker events are routed. It should be noted that the markers can also be routed to Trigger 1 Out and Trigger 2 Out, however this must be set up using the menus accessed by pressing the “Trigger” hard key.

Key Path	Source, Modulation Setup, ARB, Marker Utilities
Initial S/W Revision	A.05.00

Pulse/RF Blank

Allows you to select which marker is used for the pulse/RF blanking function. The pulse/RF blanking function blanks the RF when the marker signal goes low. The marker polarity determines when the marker signal is high. For a positive polarity, this is during the marker points. For a negative polarity, this is when there are no marker points.

Marker points should be set before using this function. Enabling this function without setting maker points may create a continuous low or high signal, dependant on the marker polarity. This causes either no RF output, or a continuous RF output.

Key Path	Source, Modulation Setup, ARB, Marker Utilities, Marker Routing
Remote Command	:SOURce:RADio:ARB:MDESTination:PULSe NONE M1 M2 M3 M4 :SOURce:RADio:ARB:MDESTination:PULSe?
Example	:SOUR:RAD:ARB:MDES:PULS NONE
Dependencies	When a new waveform is selected for playback the settings contained within the associated waveform header file are applied to the ARB. The pulse/RF blanking setting is one of the values stored within the header file. If the newly selected waveform file has an associated header file, the pulse/RF blanking setting is updated with the value from the header file. The pulse/RF blanking setting will remain unchanged if the newly selected waveform does not have an associated header file.
Range	None M1 M2 M3 M4
Initial S/W Revision	A.05.00

None

Sets no marker to be used for the pulse/RF blanking function, essentially turning the RF blanking function off.

Key Path	Source, Modulation Setup, ARB, Marker Utilities, Marker Routing, Pulse/RF Blank
Example	:SOUR:RAD:ARB:MDES:PULS NONE
Initial S/W Revision	A.05.00

Marker 1

Sets marker 1 to be used for the pulse/RF blanking function.

Key Path	Source, Modulation Setup, ARB, Marker Utilities, Marker Routing, Pulse/RF Blank
Example	:SOUR:RAD:ARB:MDES:PULS M1
Initial S/W Revision	A.05.00

Marker 2

Sets marker 2 to be used for the pulse/RF blanking function.

Key Path	Source, Modulation Setup, ARB, Marker Utilities, Marker Routing, Pulse/RF Blank
Example	:SOUR:RAD:ARB:MDES:PULS M2
Initial S/W Revision	A.05.00

Marker 3

Sets marker 3 to be used for the pulse/RF blanking function.

Key Path	Source, Modulation Setup, ARB, Marker Utilities, Marker Routing, Pulse/RF Blank
Example	:SOUR:RAD:ARB:MDES:PULS M3
Initial S/W Revision	A.05.00

Marker 4

Sets marker 4 to be used for the pulse/RF blanking function.

Key Path	Source, Modulation Setup, ARB, Marker Utilities, Marker Routing, Pulse/RF Blank
Example	:SOUR:RAD:ARB:MDES:PULS M4
Initial S/W Revision	A.05.00

ALC Hold

Allows you to specify which marker is routed for use within the ALC hold function. The ALC hold marker function holds the ALC circuitry at the average value of the sample points set by the marker.

The ALC hold function operates during the low periods of the marker signal. The marker polarity determines when the marker signal is high. For positive polarity, this is during the marker points. For a negative polarity, this is when there are no marker points.

Key Path	Source, Modulation Setup, ARB, Marker Utilities, Marker Routing
Remote Command	:SOURce:RADio:ARB:MDEStination:ALCHold NONE M1 M2 M3 M4 :SOURce:RADio:ARB:MDEStination:ALCHold?
Example	:SOUR:RAD:ARB:MDES:ALCH NONE
Dependencies	When a new waveform is selected for playback the settings contained within the associated waveform header file are applied to the ARB. The ALC hold setting is one of the values stored within the header file. If the newly selected waveform file has an associated header file, the ALC hold setting is updated with the value from the header file. The ALC hold setting will remain unchanged if the newly selected waveform does not have an associated header file.
Range	None M1 M2 M3 M4
Initial S/W Revision	A.05.00

None

Sets no marker to be used for the ALC hold function, essentially turning the ALC hold function off.

Key Path	Source, Modulation Setup, ARB, Marker Utilities, Marker Routing, ALC Hold
Example	:SOUR:RAD:ARB:MDES:PULS NONE
Initial S/W Revision	A.05.00

Marker 1

Sets marker 1 to be used for the ALC hold function.

Key Path	Source, Modulation Setup, ARB, Marker Utilities, Marker Routing, ALC Hold
Example	:SOUR:RAD:ARB:MDES:PULS M1
Initial S/W Revision	A.05.00

Marker 2

Sets marker 2 to be used for the ALC hold function.

Key Path	Source, Modulation Setup, ARB, Marker Utilities, Marker Routing, ALC Hold
Example	:SOUR:RAD:ARB:MDES:PULS M2
Initial S/W Revision	A.05.00

Marker 3

Sets marker 3 to be used for the ALC hold function.

Key Path	Source, Modulation Setup, ARB, Marker Utilities, Marker Routing, ALC Hold
Example	:SOUR:RAD:ARB:MDES:PULS M3
Initial S/W Revision	A.05.00

Marker 4

Sets marker 4 to be used for the ALC hold function.

Key Path	Source, Modulation Setup, ARB, Marker Utilities, Marker Routing, ALC Hold
Example	:SOUR:RAD:ARB:MDES:PULS M4
Initial S/W Revision	A.05.00

Header Utilities

Allows access to the header utilities sub-menu. Pressing this key also causes the central display area to change to display the File Header Information view.

Key Path	Source, Modulation Setup, ARB
Dependencies	This key is only available if there is currently a waveform selected for playback. If no waveform is selected, the key is grayed out.
Initial S/W Revision	A.05.00

Clear Header

Allows you to clear the header information from the file header associated with the currently selected waveform.

Key Path	Source, Modulation Setup, ARB, Header Utilities
Remote Command	:SOURce:RADio:ARB:HEADer:CLEar
Example	:SOUR:RAD:ARB:HEAD:CLE
Notes	Attempting to clear the header details via SCPI when no waveform was selected for playback will generate an error.
Initial S/W Revision	A.05.00

Save Setup To Header

Allows you to save new file header information details to the file.

Key Path	Source, Modulation Setup, ARB, Header Utilities
Remote Command	:SOURce:RADio:ARB:HEADer:SAVE
Example	:SOUR:RAD:ARB:HEAD:SAVE
Notes	Attempting to save the header details via SCPI when no waveform was selected for playback will generate an error.
Initial S/W Revision	A.05.00

AM

Allows access to the menu for configuring the Amplitude Modulation.

Key Path	Source, Modulation Setup
Initial S/W Revision	A.05.00

AM

Enables or disables the amplitude modulation.

Turning AM on when another modulation format is already on results in the previous modulation format being turned off and the generation of an error.

Key Path	Source, Modulation Setup, AM
Remote Command	:SOURce:AM:STATe :SOURce:AM:STATe?
Example	:SOUR:AM:STAT OFF

Preset	Off
Range	On Off
Initial S/W Revision	A.05.00

AM Depth

Allows you to set the amplitude modulation depth in percent.

Key Path	Source, Modulation Setup, AM
Remote Command	:SOURce:AM[:DEPTh] [:LINear] :SOURce:AM[:DEPTh] [:LINear]?
Example	:SOUR:AM 0.1
Preset	0.1 %
Min	0.1 %
Max	95.0 %
Initial S/W Revision	A.05.00

AM Rate

Allows you to set the internal amplitude modulation rate.

Key Path	Source, Modulation Setup, AM
Remote Command	:SOURce:AM:INTernal:FREQuency :SOURce:AM:INTernal:FREQuency?
Example	:SOUR:AM:INT:FREQ 40.0 Hz
Preset	400.0 Hz
Min	10 Hz
Max	40 kHz
Initial S/W Revision	A.05.00

FM

Allows access to the menu for configuring the frequency modulation.

Key Path	Source, Modulation Setup
Initial S/W Revision	A.05.00

FM

Enables or disables the frequency modulation.

Turning FM on when another modulation format is already on results in the previous modulation format being turned off and the generation of an error.

Key Path	Source, Modulation Setup, FM
Remote Command	:SOURce:FM:STATe :SOURce:FM:STATe?
Example	:SOUR:FM:STAT OFF
Preset	Off
Range	On Off
Initial S/W Revision	A.05.00

FM Deviation

Allows you to set the frequency modulation deviation.

Key Path	Source, Modulation Setup, FM
Remote Command	:SOURce:FM[:DEVIation] :SOURce:FM[:DEVIation]?
Example	:SOUR:FM 1.00 kHz
Preset	1.00 Hz
Min	1.00 Hz
Max	100.00 kHz
Initial S/W Revision	A.05.00

FM Rate

Allows you to set the internal frequency modulation rate.

Key Path	Source, Modulation Setup, FM
Remote Command	:SOURce:FM:INTernal:FREQuency :SOURce:FM:INTernal:FREQuency?
Example	:SOUR:FM:INT:FREQ 40.0 Hz
Preset	400.0 Hz
Min	10 Hz
Max	40 kHz
Initial S/W Revision	A.05.00

PM

Allows access to the menu for configuring the phase modulation.

Key Path	Source, Modulation Setup
Initial S/W Revision	A.05.00

PM

Enables or disables the phase modulation.

Turning PM on when another modulation format is already on results in the previous modulation format being turned off and the generation of an error.

Key Path	Source, Modulation Setup, PM
Remote Command	:SOURce:PM:STATe :SOURce:PM:STATe?
Example	:SOUR:PM:STAT OFF
Preset	Off
Range	On Off
Initial S/W Revision	A.05.00

PM Deviation

Allows you to set the phase modulation deviation.

Key Path	Source, Modulation Setup, PM
Remote Command	:SOURce:PM[:DEViation] :SOURce:PM[:DEViation]?
Example	:SOUR:PM 1.00 rad
Preset	0.1 rad
Min	0.1 rad
Max	20.0 rad
Initial S/W Revision	A.05.00

PM Rate

Allows you to set the internal phase modulation rate.

Key Path	Source, Modulation Setup, PM
Remote Command	:SOURce:PM:INTernal:FREQuency :SOURce:PM:INTernal:FREQuency?

Example	:SOUR:PM:INT:FREQ 40.0 Hz
Preset	400.0 Hz
Min	10 Hz
Max	40 kHz
Initial S/W Revision	A.05.00

List Sequencer

Allows you access to the sub-menus for configuring the list sequencer.

List sequences allows you to enter frequencies and amplitudes at unequal intervals in nonlinear ascending, descending or random order. Each step within the list can also include its own waveform file for playback, step duration, trigger event and trigger output.

The complexities involved in configuring the list sequencer do not lend itself to manual configuration; hence the manual configuration for this feature is limited. For easier configuration of the list sequencer, it is recommended that you use either SCPI or load a tab delimited file containing the setup parameters in a tabular form. The details of the SCPI for configuring the list sequencer can be found in Step Configuration (Remote Command Only).

Once the List Sequencer has been configured using the front panel, SCPI, or loading in a tab delimited file, the sequence must be initiated using the front panel Initiate Sequence key or the corresponding SCPI command.

Key Path	Source
Initial S/W Revision	A.05.00

Sequencer

Allows you to set the state of the list sequencer. When the list sequencer is on, the source is outputting the sequence defined by the sequencer. When the list sequencer is off, the source outputs a single waveform segment or sequence (independent mode) at a single frequency and amplitude.

Key Path	Source, List Sequencer
Remote Command	:SOURce:LIST[:STATe] ON OFF 1 0 :SOURce:LIST[:STATe]?
Example	:SOUR:LIST OFF
Notes	When the sequencer is set to ON, the list sequencer controls the output of the source.
Couplings	When in Sequence Analyzer mode and the list sequencer state is Off, Include Source is forced to No, and the Include Source key is grayed out. When in Sequence Analyzer mode and the list sequencer state is On, Include Source is available to set. And, an ARB memory related operation, like load or delete will be rejected.

Preset	Off
Range	On Off
Initial S/W Revision	A.05.00

Initiate Sequence

Pressing this key arms the sequence for single execution. Once the sequence is armed the source begins the sequence as soon as the trigger is received. If the trigger is set to Free Run, the sequence starts immediately.

Key Path	Source, List Sequencer
Remote Command	:SOURce:LIST:TRIGger[:IMMediate]
Example	:SOUR:LIST:TRIG
Notes	<p>When in Sequence Analyzer mode and Include Source is Yes, the Initiate list sequencer operation is rejected, and the key is grayed out, since source list sequence request is sent to physics via Parallel batch by sequence analyzer.</p> <p>If the file needed by the sequencer is not already in ARB memory, the sequence cannot be initiated and an error will be generated.</p> <p>There is a blocking SCPI query which can be used to query if source list sequence being initiated successfully or not. (see Query List Sequence Initiation Armed Status (Remote Command Only) Query Source List Sequence Armed Status)</p>
Dependencies	Under the Sequence Analyzer Mode, if Meas Setup->Include Source is set to YES, Source->List Sequencer->Initiate Sequence is disabled.
Initial S/W Revision	A.05.00

List Sequencer Setup

Allows you access to the list sequencer setup menus.

Key Path	Source, List Sequencer
----------	------------------------

Number of Steps

Allows you to specify the number of steps within the list sequence.

Key Path	Source, List Sequencer, List Sequencer Setup
Remote Command	:SOURce:LIST:NUMBer:STEPs <integer> :SOURce:LIST:NUMBer:STEPs?
Example	:SOUR:LIST:NUMB:STEP 1
Notes	Increasing the number of steps creates additional steps at the end of the list, with all the settings

	within the steps set to their default values. Decreasing the number of steps removes steps from the end of the list. The settings within the removed steps are not reset. This means that increasing the number of steps again would allow you to retrieve these steps.
Dependencies	The Step Count parameter is increased or decreased when you insert or delete a point from within the GUI interface to the sequencer.
Preset	1
Min	1
Max	1000
Initial S/W Revision	A.05.00

Current Step

Allows you to select the step number you wish to view or edit.

Key Path	Source, List Sequencer, List Sequencer Setup
Notes	No remote command, front panel only.
Preset	1
Min	1
Max	Step Count
Initial S/W Revision	A.05.00

Insert Step Before

Allows you to insert a new step, containing default values, before the currently selected step. Inserting a step will automatically increase the Step Count parameter by 1. If sequence already reaches upper limit of 1000 steps, then insert more step will be rejected and popup error –221, “Setting Conflict; Cannot insert more steps, maximum number of steps reached”

Key Path	Source, List Sequencer, List Sequencer Setup
Notes	No remote command, front panel only. If the list already contains the maximum limit of 1000 steps, no operation will be made after pressing this key.
Initial S/W Revision	A.05.00

Delete Step

Allows you to delete the current step. Deleting a step will automatically decrease the Step Count parameter by 1. If sequence only has one step left, delete step will be rejected and popup error –221, “Setting conflict; Cannot delete current step, minimum number of steps reached”

Key Path	Source, List Sequencer, List Sequencer Setup
Notes	No remote command, Front Panel key only. If the list already contains the minimum limit of 1 step, no operation will be made after pressing this key
Initial S/W Revision	A.05.00

Clear List

Allows you to clear the list. Clearing the list sets the number of steps to the default value of 1 and sets the parameters for the only step to their default values.

Key Path	Source, List Sequencer, List Sequencer Setup
Initial S/W Revision	A.05.00

Step Trigger

Allows access to the sub-menu for selecting the trigger input for the current step.

Key Path	Source, List Sequencer, List Sequencer Setup
Remote Command	:SOURce:LIST:STEP[1] 2 3...1000:SETup:INPut:TRIGger IMMEDIATE INTERNAL EXTERNAL2 KEY BUS EXTERNAL4 :SOURce:LIST:STEP[1] 2 3...1000:SETup:INPut:TRIGger?
Example	:SOUR:LIST:STEP2:SET:INP:TRIG BUS :SOUR:LIST:STEP2:SET:INP:TRIG?
Notes	SCPI is supported after A.09.40
Preset	Free Run
Range	Free Run Internal Manual (Trigger Key) Bus External 2 EXTERNAL4
Initial S/W Revision	A.05.00

Free Run

Sets the trigger input for the current step to Free Run.

Key Path	Source, List Sequencer, List Sequencer Setup, Step Trigger
Example	:SOUR:LIST:STEP2:SET:INP:TRIG IMM
Notes	SCPI is supported after A.09.40
Initial S/W Revision	A.05.00

Internal

Sets the trigger input for the current step to Internal.

Key Path	Source, List Sequencer, List Sequencer Setup, Step Trigger
Example	:SOUR:LIST:STEP2:SET:INP:TRIG INT
Notes	SCPI is supported after A.09.40
Initial S/W Revision	A.05.00

Manual (Trigger Key)

Sets the trigger input for the current step to Manual (Trigger Key). Any step in the sequence set to Manual will cause the sequence execution to stop until the manual trigger key is pressed. Sending the Bus Trigger SCPI command will have no effect. At any point in the sequence where the list sequencer is paused waiting for a software trigger, a pop up dialog is displayed until the trigger event occurs.

Key Path	Source, List Sequencer, List Sequencer Setup, Step Trigger
Example	:SOUR:LIST:STEP2:SET:INP:TRIG KEY
Notes	SCPI is supported after A.09.40
Initial S/W Revision	A.05.00

Bus

Sets the trigger input for the current step to Bus. Any step in the sequence set to Bus will cause the sequence execution to stop until the Bus Trigger SCPI command is sent. Pressing the manual trigger key has no effect. At any point in the sequence where the list sequencer is paused waiting for a software trigger, a pop up dialog is displayed until the trigger event occurs.

Key Path	Source, List Sequencer, List Sequencer Setup, Step Trigger
Example	:SOUR:LIST:STEP2:SET:INP:TRIG BUS
Notes	SCPI is supported after A.09.40
Initial S/W Revision	A.05.00

External 2

Sets the trigger input for the current step to External 2.

Key Path	Source, List Sequencer, List Sequencer Setup, Step Trigger
Example	:SOUR:LIST:STEP2:SET:INP:TRIG EXT2
Notes	SCPI is supported after A.09.40
Notes	Note: When on E6640A, trigger 2 is a bi-directional trigger port. So when trigger 2 has been configured as OUTPUT type, choosing External 2 as the input trigger for the current step will generate error.
Initial S/W Revision	A.05.00

Transition Time

Allows you to specify the transition time for the current step.

The transition time is the amount of time allowed for the source to settle at the current frequency or amplitude value.

Transition Time should not be taken as additional time before or inside the Step Duration. You can set a value for the settling time to allow the source output frequency or amplitude to become stable. Make sure that during this period of time, you do not use the source output signal.

The following table lists recommended values for appropriate settling times to allow for changes within the source.

Value Changed	Recommended Transition Time
Frequency	500 μ s
Amplitude	100 μ s to within 0.1 dB 20 μ s to within 1.0 dB

If the Transition Time value is shorter than the time necessary for the hardware to settle and a List Sequence is initiated, a **warning** is generated.

If the Transition Time value is longer than the Step Duration, an error is generated when initiating a source list sequence. For source list sequence, transition time is included in the step duration length. If the Transition Time value is longer than the Step Duration Time, the real step duration length is extended to equal the transition time and cause a timing shift.

Key Path	Source, List Sequencer, List Sequencer Setup
Remote Command	:SOURce:LIST:STEP[1] 2 3...1000:SETup:TRANSition:TIME <time> :SOURce:LIST:STEP[1] 2 3...1000:SETup:TRANSition:TIME?
Example	:SOUR:LIST:STEP2:SET:TRAN:TIME 1ms :SOUR:LIST:STEP2:SET:TRAN:TIME?
Notes	SCPI is supported after A.09.40
Preset	1.0 ms
Min	0.0 ms
Max	4.0 ks
Initial S/W Revision	A.05.00

Radio Setup

Allows you access to the sub-menus for setting up the radio standard, band, and radio band link direction for the current step.

Key Path	Source, List Sequencer, List Sequencer Setup
Notes	No remote command, front panel only.

Initial S/W Revision	A.05.00
----------------------	---------

Radio Standard

Allows access to the sub-menus for selecting the radio standard and the associated radio band for use in the current step.

Key Path	Source, List Sequencer, List Sequencer Setup, Radio Setup
Remote Command	:SOURce:LIST:STEP[1] 2 3...1000:SETup:RADio:BAND NONE PGSM EGSM RGSM DCS1800 PCS1900 TGSM810 GSM450 GSM480 GSM700 GSM850 BANDI BANDII BANDIII BANDIV BANDV BANDVI BANDVII BANDVIII BANDIX BANDX BANDXI BANDXII BANDXIII BANDXIV BANDXIX USCELL USPCS JAPAN KOREAN NMT IMT2K UPPER SECOND PAMR400 PAMR800 IMTEXT PCS1DOT9G AWS US2DOT5G PUBLIC LOWER NONE BAND1 BAND2 BAND3 BAND4 BAND5 BAND6 BAND7 BAND8 BAND10 BAND11 BAND12 BAND13 BAND14 BAND17 BAND18 BAND19 BAND20 BAND21 BAND24 BAND25 BAND26 BAND27 BAND28 BAND29 BAND30 BAND31 BAND33 BAND34 BAND35 BAND36 BAND37 BAND38 BAND39 BAND40 BAND41 BAND42 BAND43 BAND44 BANDA BANDB BANDC BANDD BANDE BANDF :SOURce:LIST:STEP[1] 2 3...1000:SETup: RADio:BAND?

Example	:SOUR:LIST:STEP2:SET:RAD:BAND PGSM :SOUR:LIST:STEP2:SET:RAD:BAND?
----------------	--

Notes	SCPI is supported after A.09.40
-------	---------------------------------

Initial S/W Revision	A.05.00
----------------------	---------

None

Selects no radio standard for use on the current step.

Key Path	Source, List Sequencer, List Sequencer Setup, Radio Setup, Radio Standard
-----------------	---

Example	:SOUR:LIST:STEP2:SET:RAD:BAND NONE
----------------	------------------------------------

Notes	SCPI is supported after A.09.40
-------	---------------------------------

Initial S/W Revision	A.05.00
----------------------	---------

GSM/EDGE

Pressing this key once selects GSM/EDGE as the radio standard and the current GSM/EDGE band as the active channel band. Pressing this key again allows access to the sub-menus for selecting a different GSM/EDGE band.

Key Path	Source, List Sequencer, List Sequencer Setup, Radio Setup, Radio Standard
-----------------	---

Initial S/W Revision	A.05.00
----------------------	---------

P-GSM

Selects P-GSM as the band for the current step.

Key Path	Source, List Sequencer, List Sequencer Setup, Radio Setup, Radio Standard, GSM/EDGE
Initial S/W Revision	A.05.00

E-GSM

Selects E-GSM as the band for the current step.

Key Path	Source, List Sequencer, List Sequencer Setup, Radio Setup, Radio Standard, GSM/EDGE
Initial S/W Revision	A.05.00

R-GSM

Selects R-GSM as the band for the current step.

Key Path	Source, List Sequencer, List Sequencer Setup, Radio Setup, Radio Standard, GSM/EDGE
Initial S/W Revision	A.05.00

DCS 1800

Selects DCS 1800 as the band for the current step.

Key Path	Source, List Sequencer, List Sequencer Setup, Radio Setup, Radio Standard, GSM/EDGE
Initial S/W Revision	A.05.00

PCS 1900

Selects PCS 1900 as the band for the current step.

Key Path	Source, List Sequencer, List Sequencer Setup, Radio Setup, Radio Standard, GSM/EDGE
Initial S/W Revision	A.05.00

GSM 450

Selects GSM 450 as the band for the current step.

Key Path	Source, List Sequencer, List Sequencer Setup, Radio Setup, Radio Standard, GSM/EDGE
Initial S/W Revision	A.05.00

GSM 480

Selects GSM 480 as the band for the current step.

Key Path	Source, List Sequencer, List Sequencer Setup, Radio Setup, Radio Standard, GSM/EDGE
Initial S/W Revision	A.05.00

GSM 850

Selects GSM 850 as the band for the current step.

Key Path	Source, List Sequencer, List Sequencer Setup, Radio Setup, Radio Standard, GSM/EDGE
Initial S/W Revision	A.05.00

GSM 700

Selects GSM 700 as the band for the current step.

Key Path	Source, List Sequencer, List Sequencer Setup, Radio Setup, Radio Standard, GSM/EDGE
Initial S/W Revision	A.05.00

T-GSM 810

Selects T-GSM 810 as the band for the current step.

Key Path	Source, List Sequencer, List Sequencer Setup, Radio Setup, Radio Standard, GSM/EDGE
Initial S/W Revision	A.05.00

WCDMA

Pressing this key once selects WCDMA as the radio standard and the current WCDMA band as the active channel band. Pressing this key again allows access to the sub-menus for selecting a different WCDMA band.

Key Path	Source, List Sequencer, List Sequencer Setup, Radio Setup, Radio Standard
Initial S/W Revision	A.05.00

Band I

Selects Band I as the band for the current step.

Key Path	Source, List Sequencer, List Sequencer Setup, Radio Setup, Radio Standard, WCDMA
Initial S/W Revision	A.05.00

Band II

Selects Band II as the band for the current step.

Key Path	Source, List Sequencer, List Sequencer Setup, Radio Setup, Radio Standard, WCDMA
Initial S/W Revision	A.05.00

Band III

Selects Band III as the band for the current step.

Key Path	Source, List Sequencer, List Sequencer Setup, Radio Setup, Radio Standard, WCDMA
Initial S/W Revision	A.05.00

Band IV

Selects Band IV as the band for the current step.

Key Path	Source, List Sequencer, List Sequencer Setup, Radio Setup, Radio Standard, WCDMA
Initial S/W Revision	A.05.00

Band V

Selects Band V as the band for the current step.

Key Path	Source, List Sequencer, List Sequencer Setup, Radio Setup, Radio Standard, WCDMA
Initial S/W Revision	A.05.00

Band VI

Selects Band VI as the band for the current step.

Key Path	Source, List Sequencer, List Sequencer Setup, Radio Setup, Radio Standard, WCDMA
Initial S/W Revision	A.05.00

Band VII

Selects Band VII as the band for the current step.

Key Path	Source, List Sequencer, List Sequencer Setup, Radio Setup, Radio Standard, WCDMA
Initial S/W Revision	A.05.00

Band VIII

Selects Band VIII as the band for the current step.

Key Path	Source, List Sequencer, List Sequencer Setup, Radio Setup, Radio Standard, WCDMA
Initial S/W Revision	A.05.00

Band IX

Selects Band IX as the band for the current step.

Key Path	Source, List Sequencer, List Sequencer Setup, Radio Setup, Radio Standard, WCDMA
Initial S/W Revision	A.05.00

Band X

Selects Band X as the band for the current step.

Key Path	Source, List Sequencer, List Sequencer Setup, Radio Setup, Radio Standard, WCDMA
Initial S/W Revision	A.05.00

Band XI

Selects Band XI as the band for the current step.

Key Path	Source, List Sequencer, List Sequencer Setup, Radio Setup, Radio Standard, WCDMA
Initial S/W Revision	A.05.00

Band XII

Selects Band XII as the band for the current step.

Key Path	Source, List Sequencer, List Sequencer Setup, Radio Setup, Radio Standard, WCDMA
Initial S/W Revision	A.05.00

Band XIII

Selects Band XIII as the band for the current step.

Key Path	Source, List Sequencer, List Sequencer Setup, Radio Setup, Radio Standard, WCDMA
Initial S/W Revision	A.05.00

Band XIV

Selects Band XIV as the band for the current step.

Key Path	Source, List Sequencer, List Sequencer Setup, Radio Setup, Radio Standard, WCDMA
Initial S/W Revision	A.05.00

LTE

Pressing this key once selects LTE FDD as the radio standard and the current LTE FDD band as the active channel band. Pressing this key again allows access to the sub-menus for selecting a different LTE FDD band.

Key Path	Source, List Sequencer, List Sequencer Setup, Radio Setup, Radio Standard
Initial S/W Revision	A.09.50

BAND 1

Selects BAND 1 as the band for the current step.

Key Path	Source, List Sequencer, List Sequencer Setup, Radio Setup, Radio Standard, LTE
Initial S/W Revision	A.09.50

BAND 2

Selects BAND 2 as the band for the current step.

Key Path	Source, List Sequencer, List Sequencer Setup, Radio Setup, Radio Standard, LTE
Initial S/W Revision	A.09.50

BAND 3

Selects BAND 3 as the band for the current step.

Key Path	Source, List Sequencer, List Sequencer Setup, Radio Setup, Radio Standard, LTE
Initial S/W Revision	A.09.50

BAND 4

Selects BAND 4 as the band for the current step.

Key Path	Source, List Sequencer, List Sequencer Setup, Radio Setup, Radio Standard, LTE
Initial S/W Revision	A.09.50

BAND 5

Selects BAND 5 as the band for the current step.

Key Path	Source, List Sequencer, List Sequencer Setup, Radio Setup, Radio Standard, LTE
Initial S/W Revision	A.09.50

BAND 6

Selects BAND 6 as the band for the current step.

Key Path	Source, List Sequencer, List Sequencer Setup, Radio Setup, Radio Standard, LTE
Initial S/W Revision	A.09.50

BAND 7

Selects BAND 7 as the band for the current step.

Key Path	Source, List Sequencer, List Sequencer Setup, Radio Setup, Radio Standard, LTE
Initial S/W Revision	A.09.50

BAND 8

Selects BAND 8 as the band for the current step.

Key Path	Source, List Sequencer, List Sequencer Setup, Radio Setup, Radio Standard, LTE
Initial S/W Revision	A.09.50

BAND 9

Selects BAND 9 as the band for the current step.

Key Path	Source, List Sequencer, List Sequencer Setup, Radio Setup, Radio Standard, LTE
Initial S/W Revision	A.09.50

BAND 10

Selects BAND 10 as the band for the current step.

Key Path	Source, List Sequencer, List Sequencer Setup, Radio Setup, Radio Standard, LTE
Initial S/W Revision	A.09.50

BAND 11

Selects BAND 11 as the band for the current step.

Key Path	Source, List Sequencer, List Sequencer Setup, Radio Setup, Radio Standard, LTE
Initial S/W Revision	A.09.50

BAND 12

Selects BAND 12 as the band for the current step.

Key Path	Source, List Sequencer, List Sequencer Setup, Radio Setup, Radio Standard, LTE
Initial S/W Revision	A.09.50

BAND 13

Selects BAND 13 as the band for the current step.

Key Path	Source, List Sequencer, List Sequencer Setup, Radio Setup, Radio Standard, LTE
Initial S/W Revision	A.09.50

BAND 14

Selects BAND 14 as the band for the current step.

Key Path	Source, List Sequencer, List Sequencer Setup, Radio Setup, Radio Standard, LTE
Initial S/W Revision	A.09.50

BAND 17

Selects BAND 17 as the band for the current step.

Key Path	Source, List Sequencer, List Sequencer Setup, Radio Setup, Radio Standard, LTE
Initial S/W Revision	A.09.50

BAND 18

Selects BAND 18 as the band for the current step.

Key Path	Source, List Sequencer, List Sequencer Setup, Radio Setup, Radio Standard, LTE
Initial S/W Revision	A.09.50

BAND 19

Selects BAND 19 as the band for the current step.

Key Path	Source, List Sequencer, List Sequencer Setup, Radio Setup, Radio Standard, LTE
Initial S/W Revision	A.09.50

BAND 20

Selects BAND 20 as the band for the current step.

Key Path	Source, List Sequencer, List Sequencer Setup, Radio Setup, Radio Standard, LTE
Initial S/W Revision	A.09.50

BAND 21

Selects BAND 21 as the band for the current step.

Key Path	Source, List Sequencer, List Sequencer Setup, Radio Setup, Radio Standard, LTE
Initial S/W Revision	A.09.50

BAND 24

Selects BAND 24 as the band for the current step.

Key Path	Source, List Sequencer, List Sequencer Setup, Radio Setup, Radio Standard, LTE
Initial S/W Revision	A.09.50

BAND 25

Selects BAND 25 as the band for the current step.

Key Path	Source, List Sequencer, List Sequencer Setup, Radio Setup, Radio Standard, LTE
Initial S/W Revision	A.09.50

BAND 26

Selects BAND 26 as the band for the current step.

Key Path	Source, List Sequencer, List Sequencer Setup, Radio Setup, Radio Standard, LTE
Initial S/W Revision	A.12.53

BAND 27

Selects BAND 27 as the band for the current step.

Key Path	Source, List Sequencer, List Sequencer Setup, Radio Setup, Radio Standard, LTE
Initial S/W Revision	A.14.00

BAND 28

Selects BAND 28 as the band for the current step.

Key Path	Source, List Sequencer, List Sequencer Setup, Radio Setup, Radio Standard, LTE
Initial S/W Revision	A.14.00

BAND 31

Selects BAND 31 as the band for the current step.

Key Path	Source, List Sequencer, List Sequencer Setup, Radio Setup, Radio Standard, LTE
Initial S/W Revision	A.14.00

LTE TDD

Sets LTE TDD as the radio standard for use and accesses the LTE TDD specific channel band sub-menus..

Key Path	Source, Frequency, Radio Setup, Radio Standard
Initial S/W Revision	A.11.50

BAND 33

Selects BAND 33 as the band for the current step.

Key Path	Source, Frequency, Radio Setup, Radio Standard, LTE TDD
Example	:SOUR:FREQ:CHAN:BAND BAND33
Initial S/W Revision	A.11.50

BAND 34

Selects BAND 34 as the band for the current step.

Key Path	Source, Frequency, Radio Setup, Radio Standard, LTE TDD
Example	:SOUR:FREQ:CHAN:BAND BAND34
Initial S/W Revision	A.11.50

BAND 35

Selects BAND 35 as the band for the current step.

Key Path	Source, Frequency, Radio Setup, Radio Standard, LTE TDD
Example	:SOUR:FREQ:CHAN:BAND BAND35
Initial S/W Revision	A.11.50

BAND 36

Selects BAND 36 as the band for the current step.

Key Path	Source, Frequency, Radio Setup, Radio Standard, LTE TDD
Example	:SOUR:FREQ:CHAN:BAND BAND36
Initial S/W Revision	A.11.50

BAND 37

Selects BAND 37 as the band for the current step.

Key Path	Source, Frequency, Radio Setup, Radio Standard, LTE TDD
Example	:SOUR:FREQ:CHAN:BAND BAND37
Initial S/W Revision	A.11.50

BAND 38

Selects BAND 38 as the band for the current step.

Key Path	Source, Frequency, Radio Setup, Radio Standard, LTE TDD
Example	:SOUR:FREQ:CHAN:BAND BAND38
Initial S/W Revision	A.11.50

BAND 39

Selects BAND 39 as the band for the current step.

Key Path	Source, Frequency, Radio Setup, Radio Standard, LTE TDD
Example	:SOUR:FREQ:CHAN:BAND BAND39
Initial S/W Revision	A.11.50

BAND 40

Selects BAND 40 as the band for the current step.

Key Path	Source, Frequency, Radio Setup, Radio Standard, LTE TDD
Example	:SOUR:FREQ:CHAN:BAND BAND40
Initial S/W Revision	A.11.50

BAND 41

Selects BAND 41 as the band for the current step.

Key Path	Source, Frequency, Radio Setup, Radio Standard, LTE TDD
Example	:SOUR:FREQ:CHAN:BAND BAND41
Initial S/W Revision	A.11.50

BAND 42

Selects BAND 42 as the band for the current step.

Key Path	Source, Frequency, Radio Setup, Radio Standard, LTE TDD
Example	:SOUR:FREQ:CHAN:BAND BAND42
Initial S/W Revision	A.11.50

BAND 43

Selects BAND 43 as the band for the current step.

Key Path	Source, Frequency, Radio Setup, Radio Standard, LTE TDD
Example	:SOUR:FREQ:CHAN:BAND BAND43
Initial S/W Revision	A.11.50

BAND 44

Selects BAND 44 as the band for the current step.

Key Path	Source, List Sequencer, List Sequencer Setup, Radio Setup, Radio Standard, LTE TDD
Initial S/W Revision	A.14.00

TDSCDMA

Sets TDSCDMA as the radio standard for use and accesses the TDSCDMA specific channel band sub-menus..

Key Path	Source, Frequency, Radio Setup, Radio Standard
Initial S/W Revision	A.11.50

BAND A

Selects BAND A as the band for the current step.

Key Path	Source, Frequency, Radio Setup, Radio Standard, TDSCDMA
Example	:SOUR:FREQ:CHAN:BAND BANDA
Initial S/W Revision	A.11.50

BAND B

Selects BAND B as the band for the current step.

Key Path	Source, Frequency, Radio Setup, Radio Standard, TDSCDMA
Example	:SOUR:FREQ:CHAN:BAND BANDB
Initial S/W Revision	A.11.50

BAND C

Selects BAND C as the band for the current step.

Key Path	Source, Frequency, Radio Setup, Radio Standard, TDSCDMA
Example	:SOUR:FREQ:CHAN:BAND BANDC
Initial S/W Revision	A.11.50

BAND D

Selects BAND D as the band for the current step.

Key Path	Source, Frequency, Radio Setup, Radio Standard, TDSCDMA
Example	:SOUR:FREQ:CHAN:BAND BANDD
Initial S/W Revision	A.11.50

BAND E

Selects BAND E as the band for the current step.

Key Path	Source, Frequency, Radio Setup, Radio Standard, TDSCDMA
Example	:SOUR:FREQ:CHAN:BAND BANDE
Initial S/W Revision	A.11.50

BAND F

Selects BAND F as the band for the current step.

Key Path	Source, Frequency, Radio Setup, Radio Standard, TDSCDMA
Example	:SOUR:FREQ:CHAN:BAND BANDF
Initial S/W Revision	A.11.50

Radio Band Link

Allows you to specify the radio band link direction for the steps within the list sequence. The link is used in conjunction with the channel band and channel number to determine the output frequency.

When set to “Uplink”, the source will calculate the uplink frequency according to an uplink formula together with selected channel band and channel number. When set to “Downlink”, the source will calculate the downlink frequency according to a downlink formula together with selected channel band and channel number.

Key Path	Source, List Sequencer, List Sequencer Setup, Radio Setup
Remote Command	:SOURce:LIST:STEP[1] 2 3...1000:SETup:RADio:BAND:LINK DOWN UP :SOURce:LIST:STEP[1] 2 3...1000:SETup:RADio:BAND:LINK?
Example	:SOUR:LIST:STEP2:SET:RAD:BAND:LINK UP :SOUR:LIST:STEP2:SET:RAD:BAND:LINK?
Notes	SCPI is supported after A.09.40
Preset	DOWN
Range	DOWN UP
Initial S/W Revision	A.05.00

Channel

Allows you to specify the frequency of the current step via a channel number.

Key Path	Source, List Sequencer, List Sequencer Setup
Remote Command	:SOURce:LIST:STEP[1] 2 3...1000:SETup:CNFRrequency <double> :SOURce:LIST:STEP[1] 2 3...1000:SETup:CNFRrequency?
Example	:SOUR:LIST:STEP2:SET:CNFR 124 :SOUR:LIST:STEP2:SET:CNFR?
Notes	SCPI is supported after A.09.40. This SCPI is used to setup channel number or frequency setting, according to current Radio Band setting. If Radio Band is "NONE", then it's frequency. If Radio Band is not "NONE", then it's channel number.
Couplings	The channel number is coupled to the step frequency value. When the step frequency value is changed, the channel number will increase or decrease to match the new step frequency. If the step frequency is not at an exact match for a channel number, the nearest channel number is displayed, along with a greater than, or less than sign to indicate the frequency is above or below the channel number.
Preset	1
Min	0 (Please refer to for valid ranges.)
Max	10838 (Please refer to for valid ranges.)
Initial S/W Revision	A.05.00

Frequency

Allows you to specify a frequency value for the current step.

Key Path	Source, List Sequencer, List Sequencer Setup
Remote Command	:SOURce:LIST:STEP[1] 2 3...1000:SETup:CNFRrequency <double> :SOURce:LIST:STEP[1] 2 3...1000:SETup:CNFRrequency?
Example	:SOUR:LIST:STEP2:SET:CNFR 1GHz :SOUR:LIST:STEP2:SET:CNFR?
Notes	SCPI is supported after A.09.40. This SCPI is used to setup channel number or frequency setting, according to current Radio Band setting. If Radio Band is "NONE", then it's frequency. If Radio Band is not "NONE", then it's channel number.
Couplings	The frequency value is coupled to the channel band and number for the step, such that updates to the radio band and channel number will update the frequency value to the corresponding absolute frequency. The reverse is also true, changing the frequency value causes the value of the channel number to be updated.
Preset	1.00 GHz
Min	10.00 MHz
Max	Hardware Dependant:

	Option 503 = 3.6 GHz Option 504 = 3.9 GHz Option 506 = 6.00 GHz
Initial S/W Revision	A.05.00

Power

Allows you to specify a power value for the current step.

Key Path	Source, List Sequencer, List Sequencer Setup
Remote Command	:SOURce:LIST:STEP[1] 2 3...1000:SETup:AMPLitude <double> :SOURce:LIST:STEP[1] 2 3...1000:SETup:AMPLitude?
Example	:SOUR:LIST:STEP2:SET:AMPL -50dBm :SOUR:LIST:STEP2:SET:AMPL?
Notes	SCPI is supported after A.09.40
Notes	Amplitude corrections can be specified for use with the source. In the event of amplitude corrections being applied, the valid ranges for the RF power do not change dependant on the current amplitude correction setting. Instead, if the combination of RF power + amplitude correction is higher or lower than the source output range, the Source Unleveled bit is set and the "Source Unleveled" indicator will appear on status panel to indicate that the source cannot maintain the output power that has been requested. The multiport adapter RFIO TX ports and GPS ports cannot ensure power accuracy when power setting is lower than -130dBm, this power setting value is defined by the sum of RF Power setting and related amplitude correction value. But user settable value could be lower than this limit. When application detected there exists power setting lower than -130dBm on MPA RFIO TX ports, then popup warning message . When application detected there exists power setting lower than -130dBm on MPA GPS ports, then popup warning message . These are only warning messages, and check is performed when RF is ON.
Notes	The Min and Max value here defined UI settable amplitude range. This range is larger than actual amplitude range with level accuracy defined in spec.
Dependencies	The RF power is dependent on the RF output port and frequency, such that the current frequency and selected output port determine the valid range of power values.
Preset	-100 dBm
Min	The range of values depends on the current frequency and selected RF output port. Please refer to "RF Power" on page 2098 and the table RF Power Range for the valid ranges.
Max	The range of values depends on the current frequency and selected RF output port. Please refer to "RF Power" on page 2098 and the table RF Power Range for the valid ranges.
Initial S/W Revision	A.05.00

Waveform

Allows you access to the sub-menus for selecting the waveform to be played back during the current step. Pressing this key also changes the central display area to show the Waveform File Selection view.

Key Path	Source, List Sequencer, List Sequencer Setup
Remote Command	:SOURce:LIST:STEP[1] 2 3...1000:SETup:WAVeform <string> :SOURce:LIST:STEP[1] 2 3...1000:SETup:WAVeform?
Example	:SOUR:LIST:STEP2:SET:WAV "CW" :SOUR:LIST:STEP2:SET:WAV?
Notes	SCPI is supported after A.09.40
Remote Command Notes	String type, takes "Off" "CW" "Cont" "waveform name"
Preset	CW
Range	Waveform Continue Previous CW Off
Initial S/W Revision	A.05.00

CW

Sets the current step to output a CW tone.

Key Path	Source, List Sequencer, List Sequencer Setup, Waveform
Example	:SOUR:LIST:STEP2:SET:WAV "CW"
Notes	SCPI is supported after A.09.40
Initial S/W Revision	A.05.00

Selected Waveform

Inserts the currently selected waveform in the waveform selection view as the waveform for playback during the current step.

Key Path	Source, List Sequencer, List Sequencer Setup, Waveform
Example	:SOUR:LIST:STEP2:SET:WAV "waveform name"
Notes	SCPI is supported after A.09.40 If the selected waveform contains header (which contains ARB play parameters), source list sequence will automatically apply header settings of the selected waveform in that step.
Initial S/W Revision	A.05.00

Continue Previous

Sets the current step to continue with playback of the waveform from the previous step. When continuing the previous waveform, the ARB playback will not pause while the source retunes to the new frequency or amplitude that may be defined for the new step.

Key Path	Source, List Sequencer, List Sequencer Setup, Waveform
----------	--

Example	:SOUR:LIST:STEP2:SET:WAV "Cont"
Notes	SCPI is supported after A.09.40
Initial S/W Revision	A.05.00

Off

Disable RF output of the current step.

Key Path	Source, List Sequencer, List Sequencer Setup, Waveform
Example	:SOUR:LIST:STEP2:SET:WAV "Off"
Notes	SCPI is supported after A.09.40
Initial S/W Revision	A.05.00

Segments on Hard Disk

Allows you access to the sub-menus for loading waveform segments from the hard disk into ARB memory. The default directory is: D: varb.

Pressing this key changes the current view to the Waveform Management View.

Key Path	Source, Modulation Setup, ARB, Select Waveform
Initial S/W Revision	A.05.00

Load Segment To ARB Memory

Allows you to load the selected file into ARB memory. On the front panel you select the file for loading to the ARB memory by highlighting the desired file in the list. Using the SCPI command, you specify the file name on the HDD.

"NVWFM" (none-volatile storage) MSUS (Mass Storage Unit Specifier) is supported in the memory subsystem because the ARB memory cannot be accessed directly. Therefore, files must be downloaded to the instrument hard disk and then loaded into the ARB memory. "NVWFM" MSUS will be mapped to the default directory D: VARB. The SCPI command supports using either "NVWFM" MSUS or specifying a full path. For more information, see Memory Subsystem (Remote Command Only).

If a file of the same name already exists within ARB memory, it is overwritten. If you wish to load two segments of the same name, you must rename one of the segments before loading it into ARB memory. To rename a segment, you can either use Windows File Explorer, or the :MMEMory:COPY command.

NOTE: When a waveform file is loaded to ARB memory, burst timing adjustments are made automatically, based on whether or not a Multiport Adapter is connected to the test set and powered on. If the connection/power status of the Multiport Adapter is changed after a waveform file has been loaded, it needs to be loaded again.

Key Path	Source, Modulation Setup, ARB, Select Waveform, Segments on Hard Disk
Remote Command	:SOURce:RADio:ARB:LOAD <string>
Example	:SOUR:RAD:ARB:LOAD "D: VARB\testwaveform.bin" or :SOUR:RAD:ARB:LOAD "NVWFM:testwaveform.bin"
Notes	<p>Because loading the file involves a delay of unpredictable length, this command should be followed by the query *OPC?, which holds off subsequent commands until the loading operating is complete.</p> <p><string> – specifies the path name of the file to load from the HDD into ARB memory. It could be a <full path + filename>, or <"NVWFM" MSUS + colon + filename>.</p> <p>When in Sequence Analyzer mode, and Include Source is Yes, an attempt to load a file to ARB memory will be rejected with an error.</p> <p>When Include Source is No and if there is insufficient free ARB memory to load the selected waveform, an error is generated. .</p> <p>If you specify a file over SCPI, but the file is not at the specified location, an error is generated.</p> <p>If you try to load a waveform file but the file contains less than 500 IQ samples, an error is generated.</p> <p>If you try to load a Signal Studio waveform "*.wfm" which contains invalid waveform header, an error is generated.</p> <p>If the ARB is ON when you load a file to ARB memory or delete a file from ARB memory, the playing waveform segment may not keep phase continuity during the ARB memory operation. The waveform will be replayed after the ARB operation is finished.</p> <p>ARB can be loaded into ARB memory even required licenses do not present on the instrument. In this case, a GUI only warning message -800, "Operation complete; Loaded <filename> successfully, but no license <required licenses> installed". User can install required licenses according to <required licenses> string to license it, or multi-pack license it.</p>
Initial S/W Revision	A.05.00

Load All To ARB Memory

Allows you to load all the segment files within the currently selected directory into ARB memory. If a file of the same name already exists within ARB memory, it is overwritten. If you wish to load two segments of the same name, you must rename one of the segments before loading it into ARB memory. To rename a segment, you can either use Windows File Explorer, or the :MEMory:COpy command.

NOTE: When a waveform file is loaded to ARB memory, burst timing adjustments are made automatically, based on whether or not a Multiport Adapter is connected to the test set and powered on. If the connection/power status of the Multiport Adapter is changed after a waveform file has been loaded, it needs to be loaded again.

Key Path	Source, Modulation Setup, ARB, Select Waveform, Segments on Hard Disk
Remote Command	:SOURce:RADio:ARB:LOAD:ALL <string>
Example	:SOUR:RAD:ARB:LOAD:ALL "D: varb"
Notes	<p><string> - specifies the directory on the HDD to load the files into ARB memory from.</p> <p>When in Sequence Analyzer mode, and Include Source is Yes, an attempt to load all files from a directory to ARB memory is rejected with an error.</p>

When Include Source is No and there is insufficient free ARB memory to load all the waveforms, when the ARB memory is full, the copy ceases, and an error is generated.

If you specify a directory over SCPI, but the directory does not exist, an error is generated.

If the ARB is ON, a user then loads or deletes file to ARB memory, the playing waveform segment may not keep phase continuity during the ARB memory operation. The waveform will be replayed after the ARB operation is finished.

Initial S/W Revision	A.05.00
----------------------	---------

Change Directory...

Allows you to change the currently selected directory on the hard disk. Pressing this key opens a standard windows change directory dialog allowing you to select the new directory of interest.

The current directory is used for manually loading waveform segments into ARB memory for playback, and as a search location for waveform segments that are required to be loaded into ARB memory for playback of a waveform sequence or a list sequence.

Key Path	Source, Modulation Setup, ARB, Select Waveform, Segments on Hard Disk
Notes	No remote command, SCPI front panel only.
Initial S/W Revision	A.05.00

Default Directory...

Allows you to change the default directory. It is used as a search location for waveform segments that are required to be loaded into ARB memory for playback of a waveform sequence, and as a search location for selecting waveforms using SCPI.

Key Path	Source, Modulation Setup, ARB, Select Waveform, Segments on Hard Disk
Remote Command	:SOURce:RADio:ARB:DEFault:DIRectory <string> :SOURce:RADio:ARB: DEFault:DIRectory?
Example	:SOUR:RAD:ARB:DEF:DIR "D:\ArbFiles" :SOUR:RAD:ARB:DEF:DIR?
State Saved	Persistent, survives a power cycle and a preset but not saved in the instrument state
Initial S/W Revision	A.05.00

Segments in ARB Memory

Allows you access to the sub-menus for managing the files within ARB memory.

Key Path	Source, Modulation Setup, ARB, Select Waveform
Initial S/W Revision	A.05.00

Delete Segment From ARB Mem

Allows you to remove a segment from ARB playback memory.

Key Path	Source, Modulation Setup, ARB, Select Waveform, Segments in ARB Memory
Remote Command	:SOURce:RADio:ARB:DELeTe <string>
Example	:SOUR:RAD:ARB:DEL "testwaveform.bin"
Notes	<p><string> - specifies the waveform to be deleted from the ARB playback memory.</p> <p>When in Sequence Analyzer mode and Include Source is Yes, an attempt to delete a file from ARB memory is rejected with an error.</p> <p>When Include Source is No and you specify a file that does not exist within ARB memory, an error is generated.</p> <p>It is possible to delete files from within the ARB memory when the ARB is ON. However, if you attempt to delete the file that is currently playing an error is generated.</p> <p>It is possible to delete a file from within the ARB memory when the sequencer state is ON and the file is not being used by the List Sequencer. If you attempt to delete a file which is being used by the list sequencer, an error is generated.</p> <p>When sequencer state is On, even if ARB state is On, the selected waveform will not be played. In this case, if the selected waveform is not used in List Sequence, it can be deleted and the ARB state is turned Off.</p> <p>If the ARB is ON and you load a file to ARB memory or delete a file from ARB memory, the playing waveform segment may not keep phase continuity during the ARB memory operation. The waveform will be replayed after the ARB operation is finished.</p>
Initial S/W Revision	A.05.00

Delete All From ARB Memory

Allows you to remove all segments from ARB playback memory.

Key Path	Source, Modulation Setup, ARB, Select Waveform, Segments in ARB Memory
Remote Command	:SOURce:RADio:ARB:DELeTe:ALL
Example	:SOUR:RAD:ARB:DELeTe:ALL
Notes	<p>When in Sequence Analyzer mode and Include Source is Yes, an attempt to delete all files from ARB memory is rejected with an error.</p> <p>When Include Source is No and you attempt to delete all files from ARB memory when the ARB is currently playing a file, all files except the one playing are deleted and an error is generated.</p> <p>If you attempt to delete all files from ARB memory when there are waveform files used in "List Sequencer" on page 2168 and "Sequencer" on page 2168 state is ON, all files except the files currently being used in list sequencer are deleted, and an error is generated.</p> <p>If the ARB is ON and you load a file to ARB memory or delete a file from ARB memory, the playing waveform segment may not keep phase continuity during the ARB memory operation. The waveform will be replayed after the ARB operation is finished.</p>
Initial S/W Revision	A.05.00

Step Duration

Allows access to the sub-menus for setting up the duration of play for the current step.

The duration can be set to be either the number of times for the ARB file associated with the sequence to play, or a specific time value, or continuous. If the step is set to play a CW tone, the step duration cannot be set to a play count.

Key Path	Source, List Sequencer, List Sequencer Setup
Remote Command	:SOURce:LIST:STEP[1] 2 3...1000:SETup:DURation:TYPE TIME COUNT CONTInuous CABort :SOURce:LIST:STEP[1] 2 3...1000:SETup:DURation:TYPE?
Example	:SOUR:LIST:STEP2:SET:DUR:TYPE TIME :SOUR:LIST:STEP2:SET:DUR:TYPE?
Notes	SCPI is supported after A.09.40
Notes	If “Step Duration” is set to “Time” or “Play Count” for the last step, the last step of ARB keeps playing as if set to “Continuous”, until the set “Time” has expired or until the “Play Count” setting is reached. However, you can query Error! Reference source not found. Source Sweeping Condition Message to find out if the current list sequence is complete or not.
Range	Time Play Count Continuous Continuous Abort
Initial S/W Revision	A.05.00

Time

Sets the duration of the current step to be a time value for the length of time the step will play. Pressing this key again opens another menu which allows you to set the time value for the step duration.

Key Path	Source, List Sequencer, List Sequencer Setup, Step Duration
Example	:SOUR:LIST:STEP2:SET:DUR:TYPE TIME
Notes	SCPI is supported after A.09.40
Initial S/W Revision	A.05.00

Duration Time

Allows you to specify the length of time the current step will play.

If the Transition Time value is longer than the Step Duration Time, an error is generated when initiating a source list sequence. For source list sequence, transition time is included in the step duration length (not occupy additional time). If the Transition Time value is longer than the Step Duration Time, the real step duration length is extended to equal the transition time and cause a timing shift. This check is also described in section **Error! Reference source not found.** List Sequence Step Validation.

Key Path	Source, List Sequencer, List Sequencer Setup, Step Duration, Time
Remote Command	:SOURce:LIST:STEP[1] 2 3...1000:SETup:DURation:TCOUNT <double> :SOURce:LIST:STEP[1] 2 3...1000:SETup:DURation:TCOUNT?

Example	:SOUR:LIST:STEP2:SET:DUR:TCO 1s :SOUR:LIST:STEP2:SET:DUR:TCO?
Notes	SCPI is supported after A.09.40 This SCPI is reused by "Play Count", "Duration Time" and "Continuous Abort" according to current Duration Type setting is "Play Count" or "Duration Time" or "Continuous Abort". If current "Duration Type" is "Continuous", then popup error -221, "Settings conflict; Cannot accept time or count input when step duration type is Continuous on step #"
Notes	If "Duration Time" is set for the last step, the last step of ARB keeps playing as if set to "Continuous" after set time expires. However, you can query Source Sweeping Condition Message (:STAT:OPER:COND?) to find out if the current list sequence is complete or not.
Preset	1.00 ms
Min	100 µs
Max	1800 s
Initial S/W Revision	A.05.00

Play Count

Sets the duration of the current step to be an integer value for the number of times (play count) the ARB file is selected for playback during this step. For example, a 5 second ARB will be set to play 5 times during the step.

Key Path	Source, List Sequencer, List Sequencer Setup, Step Duration
Example	:SOUR:LIST:STEP2:SET:DUR:TYPE COUN
Notes	SCPI is supported after A.09.40 This key is unavailable and is grayed out if the current step is configured to CW tone rather than an ARB waveform.
Initial S/W Revision	A.05.00

Header Utilities

Allows access to the header utilities sub-menu. Pressing this key also causes the central display area to change to display the File Header Information view.

Key Path	Source, Modulation Setup, ARB
Dependencies	This key is only available if there is currently a waveform selected for playback. If no waveform is selected, the key is grayed out.
Initial S/W Revision	A.05.00

Continuous

Sets the current step to be played continuously until the next step starts. The waveform will always play completely before transitioning to the next step.

Key Path	Source, List Sequencer, List Sequencer Setup, Step Duration
Example	:SOUR:LIST:STEP2:SET:DUR:TYPE CONT
Notes	SCPI is supported after A.09.40
Initial S/W Revision	A.05.00

Output Trigger

Allows you to specify the trigger output for the current step. The trigger output signal is sent at the start of the step.

When select “On”, trigger event will occur on both Internal and External2 paths. Select “Off” will turn off trigger output.

Key Path	Source, List Sequencer, List Sequencer Setup
Remote Command	:SOURce:LIST:STEP[1] 2 3...1000:SETup:OUTPut:TRIGger ON OFF 1 0 :SOURce:LIST:STEP[1] 2 3...1000:SETup:OUTPut:TRIGger
Example	:SOUR:LIST:STEP2:SET:OUTP:TRIG ON :SOUR:LIST:STEP2:SET:OUTP:TRIG?
Notes	SCPI is supported after A.09.40
Preset	Off
Range	On Off
Initial S/W Revision	A.05.00

Repetition

Allows access to the sub-menu for selecting the repetition type for the list sequencer globally. It cannot be changed between different sequence steps.

Key Path	Source, List Sequencer
Remote Command	:SOURce:LIST:REPetition:TYPE SINGLE CONTInuous
Example	:SOUR:LIST:REP:TYPE SING :SOUR:LIST:REP:TYPE?
Preset	SINGle
Range	SINGle CONTInuous
Initial S/W Revision	A.14.50

Single

Sets the repetition type as single for the whole source sequence. Source list will play one time after initiation.

Key Path	Source, List Sequencer, Repetition
Example	:SOUR:LIST:REP:TYPE SINGLE
Initial S/W Revision	A.14.50

Continuous

Sets the repetition type as continuous for the whole source sequence. Source list will play continuously after initiation.

Key Path	Source, List Sequencer, Repetition
Example	:SOUR:LIST:REP:TYPE CONTInuous
Initial S/W Revision	A.14.50

Trigger Type

Allows access to the sub-menu for selecting the output trigger type for the list sequencer globally. It cannot be changed between different sequence steps.

Key Path	Source, List Sequencer
Remote Command	:SOURce:LIST:TRIGgerout:TYPe BEGInningofstep DATamarker
Example	:SOUR:LIST:TRIG:TYP BEG :SOUR:LIST:TRIG:TYP?
Notes	SCPI is supported after A.14.00
Preset	BEGInningofstep
Range	BEGInningofstep DATamarker
Initial S/W Revision	A.14.00

BeginningOfStep

Sets the output trigger type as BeginningOfStep for the whole source sequence.

Key Path	Source, List Sequencer, Trigger Type
Example	:SOUR:LIST:TRIG:TYP BEG
Notes	SCPI is supported after A.14.00
Initial S/W Revision	A.14.00

DataMarker

Sets the output trigger type as DataMarker for the whole source sequence. When DataMarker is selected, which marker to route is also needed to be set.

Key Path	Source, List Sequencer, Trigger Type
Example	:SOUR:LIST:TRIG:TYP DAT
Notes	SCPI is supported after A.14.00
Initial S/W Revision	A.14.00

Marker 1

Sets the output trigger maker routing to Marker 1 for DataMarker in the whole source sequence.

Key Path	Source, List Sequencer, Trigger Type, DataMarker
Example	:SOUR:LIST:TRIG:TYPE:MARK M1
Notes	SCPI is supported after A.14.00
Initial S/W Revision	A.14.00

Marker 2

Sets the output trigger maker routing to Marker 2 for DataMarker in the whole source sequence.

Key Path	Source, List Sequencer, Trigger Type, DataMarker
Example	:SOUR:LIST:TRIG:TYPE:MARK M2
Notes	SCPI is supported after A.14.00
Initial S/W Revision	A.14.00

Marker 3

Sets the output trigger maker routing to Marker 3 for DataMarker in the whole source sequence.

Key Path	Source, List Sequencer, Trigger Type, DataMarker
Example	:SOUR:LIST:TRIG:TYPE:MARK M3
Notes	SCPI is supported after A.14.00
Initial S/W Revision	A.14.00

Marker 4

Sets the output trigger maker routing to Marker 4 for DataMarker in the whole source sequence.

Key Path	Source, List Sequencer, Trigger Type, DataMarker
Example	:SOUR:LIST:TRIG:TYPE:MARK M4
Notes	SCPI is supported after A.14.00
Initial S/W Revision	A.14.00

Manual Trigger Now

Pressing this key provides a software trigger event to the list sequencer. During execution of sequence, if the sequencer is halted on any step that has been configured with a “Manual” step trigger, then this key press will cause the sequencer to continue and execute the step.

Key Path	Source, List Sequencer
Remote Command	No remote command, front panel only.
Initial S/W Revision	A.05.00

Source Preset

Allows you to preset the source settings to their default values.

Key Path	Source
Remote Command	:SOURce:PRESet
Example	:SOUR:PRES

Span X Scale

Accesses a menu of functions that enable you to set the horizontal scale parameters.

Key Path	Front-panel key
Initial S/W Revision	A.11.00

Ref Value

Sets the X reference value.

Key Path	SPAN X Scale
Mode	BASIC, PNOISE, WCDMA, C2K, GSM, WIMAXOFDMA, TDSCDMA, 1XEVDO, DVB, DTMB, ISDBT, CMMB, LTE, LTETDD, DCTV, WLAN, MSR, LTEAFDD, LTEATDD
Remote Command	:DISPlay:SEMask:VIEW[1]:WINDow[1]:TRACe:X[:SCALE]:RLEVel <freq> :DISPlay:SEMask:VIEW[1]:WINDow[1]:TRACe:X[:SCALE]:RLEVel?
Example	DISP:SEM:VIEW:WIND:TRAC:X:RLEV 10 DISP:SEM:VIEW:WIND:TRAC:X:RLEV?
Notes	You must be in the mode that includes SEM measurement to use this command. Use :INSTrument:SElect to set the mode.
Couplings	If Auto Scaling is set to On, this value is automatically determined by the measurement result. When you set this value manually, Auto Scaling automatically changes to Off.
Preset	1.0 GHz
State Saved	Saved in instrument state.
Min	-1000 GHz
Max	1000 GHz
Default Unit	Hz
Initial S/W Revision	A.11.00

Scale/Div

Sets the horizontal scale.

Key Path	SPAN X Scale
Mode	BASIC, PNOISE, WCDMA, C2K, GSM, WIMAXOFDMA, TDSCDMA, 1XEVDO, DVB, DTMB, ISDBT, CMMB, LTE, LTETDD, DCTV, WLAN, MSR, LTEAFDD, LTEATDD
Remote Command	:DISPlay:SEMask:VIEW[1]:WINDow[1]:TRACe:X[:SCALE]:PDIVision <freq> :DISPlay:SEMask:VIEW[1]:WINDow[1]:TRACe:X[:SCALE]:PDIVision ?
Example	DISP:SEM:VIEW:WIND:TRAC:X:PDIV 500 DISP:SEM:VIEW:WIND:TRAC:X:PDIV?

Notes	You must be in a mode that includes the SEM measurement to use this command. Use INSTRUMENT:SElect to set the mode.
Couplings	If Auto Scaling is set to On, this value is automatically determined by the measurement result. When you set this value manually, Auto Scaling automatically changes to Off.
Preset	Automatically Calculated
State Saved	Yes Saved in instrument state.
Min	1 Hz
Max	10.0 GHz
Initial S/W Revision	A.11.00

Ref Position

Sets the reference position for the X axis to Left, Center or Right.

Key Path	SPAN X Scale
Mode	BASIC, PNOISE, WCDMA, C2K, GSM, WIMAXOFDMA, TDSCDMA, 1XEVD0, DVB, DTMB, ISDBT, CMMB, LTE, LTETDD, DCTV, WLAN, MSR, LTEAFDD, LTEATDD
Remote Command	:DISPlay:SEMAsk:VIEW[1]:WINDow[1]:TRACe:X[:SCALe]:RPOStion LEFT CENTER RIGHT :DISPlay:SEMAsk:VIEW[1]:WINDow[1]:TRACe:X[:SCALe]:RPOStion?
Example	DISP:SEM:VIEW:WIND:TRAC:X:RPOS LEFT DISP:SEM:VIEW:WIND:TRAC:X:RPOS?
Notes	You must be in a mode that includes the SEM measurement to use this command. Use INSTRUMENT:SElect to set the mode.
Preset	CENTER
State Saved	Yes Saved in instrument state.
Range	Left Ctr Right
Initial S/W Revision	A.11.00

Auto Scaling

Toggles the scale coupling function between On and Off.

Key Path	SPAN X Scale
Mode	BASIC, PNOISE, WCDMA, C2K, GSM, WIMAXOFDMA, TDSCDMA, 1XEVD0, DVB, DTMB, ISDBT, CMMB, LTE, LTETDD, DCTV, WLAN, MSR, LTEAFDD, LTEATDD
Remote Command	:DISPlay:SEMAsk:VIEW[1]:WINDow[1]:TRACe:X[:SCALe]:COUPlE 0 1 OFF ON :DISPlay:SEMAsk:VIEW[1]:WINDow[1]:TRACe:X[:SCALe]:COUPlE?
Example	DISP:SEM:VIEW:WIND:TRAC:X:COUP ON

DISP:SEM:VIEW:WIND:TRAC:X:COUP?	
Notes	You must be in a mode that includes the SEM measurement to use this command. Use INSTRument:SElect to set the mode.
Couplings	When Auto Scaling is On and the Restart front-panel key is pressed, this function automatically determines the scale per division and reference values based on the measurement results. When you set a value to either Scale/Div or Ref Value manually, Auto Scaling automatically changes to Off.
Preset	1
State Saved	Yes Saved in instrument state.
Range	On Off
Initial S/W Revision	A.11.00

Sweep/Control

Displays a menu that enables you to set up and control the sweep time, gate method, and source of the current measurement. See Sweep/Control for more information.

Key Path	Front-panel key
Initial S/W Revision	Prior to A.02.00

Pause

Pauses a measurement after the current data acquisition is complete. When Paused, the label on the key changes to Resume. Pressing the Resume key resumes the measurement at the point it was at when paused. See Pause/Resume for more details.

Key Path	Sweep/Control
Initial S/W Revision	Prior to A.02.00

Gate

Accesses a menu that enables you to control the gating function. The Gate functionality is used to view signals best viewed by qualifying them with other events.

Gate setup parameters are the same for all measurements – they do not change as you change measurements. Settings like these are called “Meas Global” and are unaffected by Meas Preset.

Key Path	Sweep/Control
Scope	Meas Global
Readback	The state and method of Gate, as [Off, FFT] or [On, FFT]. Note that for measurements that only support gated FFT, the method is nonetheless read back, but always as FFT.
Initial S/W Revision	Prior to A.02.00

Gate On/Off

Turns the gate function on and off.

When the Gate Function is on, the selected Gate Method is used along with the gate settings and the signal at the gate source to control the sweep system with the gate signal. Not all measurements allow every type of Gate Methods.

When Gate is on, the annunciation in the measurement bar reflects that it is on and what method is used, as seen in the following "Gate: FFT" annunciator graphic.

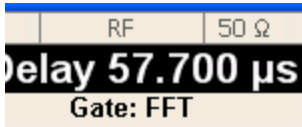

Key Path	Sweep/Control, Gate
Remote Command	[:SENSe] :SWEep:EGATe [:STATe] OFF ON 0 1 [:SENSe] :SWEep:EGATe [:STATe] ?
Example	SWE:EGAT ON SWE:EGAT?
Dependencies	<p>When in the ACP measurement:</p> <ul style="list-style-type: none"> • When Meas Method is RBW or FAST, this function is unavailable and the key is grayed out. • Whenever Gate is on, Meas Method, RBW or FAST is unavailable and keys for those are grayed out. • When Gate is on, Offset Res BW and Offset Video BW are ignored (if you set these values) and the measurement works as if all Offset Res BW and all Offset Video BW are coupled with the Res BW and the Video BW under the BW menu. When Gate is on, the Offset BW key in the Offset/Limit menu is grayed out.
Preset	Off LTETDD: On
State Saved	Saved in instrument state
Range	On Off
Backwards Compatibility SCPI	[:SENSe] :SWEep:TIME:GATE [:STATe] ESA compatibility
Backwards Compatibility Notes	In ESA, Trig Delay (On) and Gate (On) could not be active at the same time.. This dependency does not exist in PSA or in the X-Series.
Initial S/W Revision	Prior to A.02.00

Gate View On/Off

Turning on Gate View in the Swept SA measurement provides a single-window gate view display..

Turning on Gate View in other measurements shows the split-screen Gate View. In these measurements, when the Gate View is on, the regular view of the current measurement traces and results are reduced vertically to about 70% of the regular height. The Zero Span window, showing the positions of the Gate, is shown between the Measurement Bar and the reduced measurement window. By reducing the height of the measurement window, some of the annotation on the Data Display may not fit and is not shown.

Key Path	Sweep/Control, Gate
Remote Command	[:SENSe] :SWEep:EGATe:VIEW ON OFF 1 0 [:SENSe] :SWEep:EGATe:VIEW?
Example	SWE:EGAT:VIEW ON turns on the gate view.

Dependencies	<p>In the Swept SA measurement:</p> <p>In Gate View, the regular Acq Time key is grayed out . When pressed, the grayed out key puts up the informational message "Use Gate View Sweep Time in the Gate menu."</p> <p>In the other measurements:</p> <p>When you turn Gate View on, the lower window takes on the current state of the instrument. Upon leaving Gate View, the instrument takes on the state of the lower window.</p> <p>When you turn Gate View on, the upper window Acquisition Time is set to the gate view acquisition time.</p>
Couplings	<p>These couplings apply to the Swept SA measurement:</p> <ul style="list-style-type: none">• When Gate View is turned on, the instrument is set to Zero Span.• Gate View automatically turns off whenever a Span other than Zero is selected.• Gate View automatically turns off if you press the Last Span key while in Gate View, and the instrument returns to the Span it was in before entering Gate View (even if that is Zero Span).• When Gate View is turned on, the sweep time used is the gate view sweep time. This is set according to the rules in section "Gate View Setup " on page 1437• When Gate View is turned off, Sweep Time is set to the normal Swept SA measurement sweep time.• If Gate View is on and Gate is off, then turning on Gate turns off Gate View.
Preset	OFF
State Saved	Saved in instrument state
Range	On Off
Initial S/W Revision	Prior to A.02.00

A sample of the Gate View screen in the Swept SA measurement is shown in the following graphic :

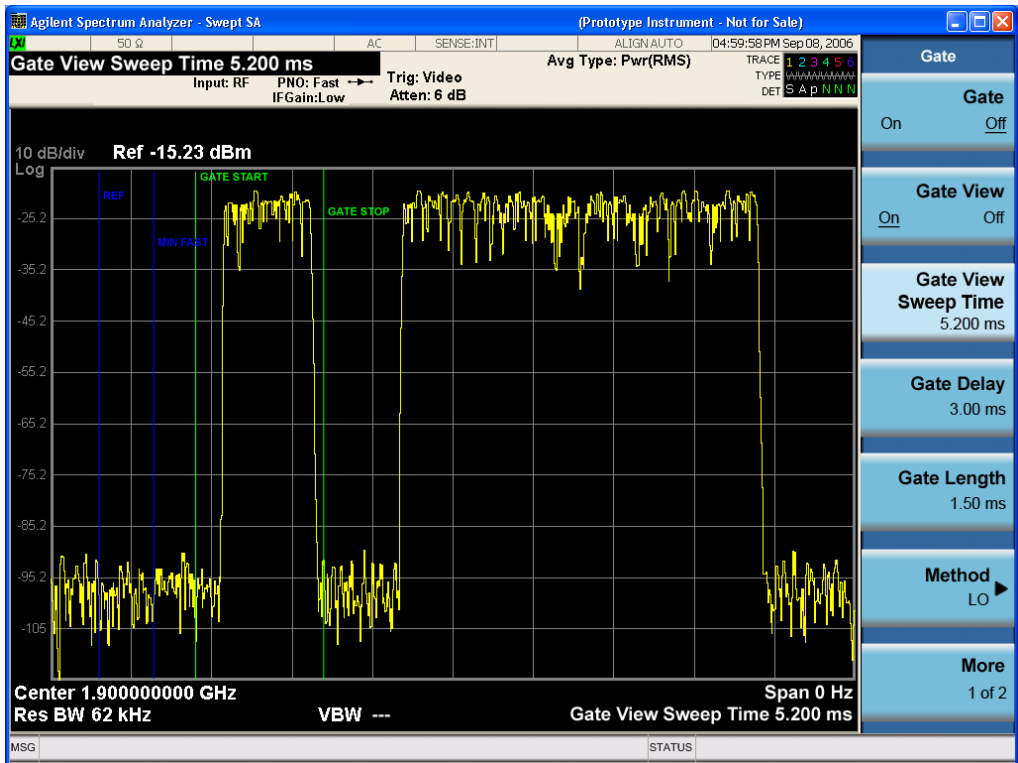

A sample of the Gate View screen in other measurements is shown in the following graphic. This example is for the ACP measurement:

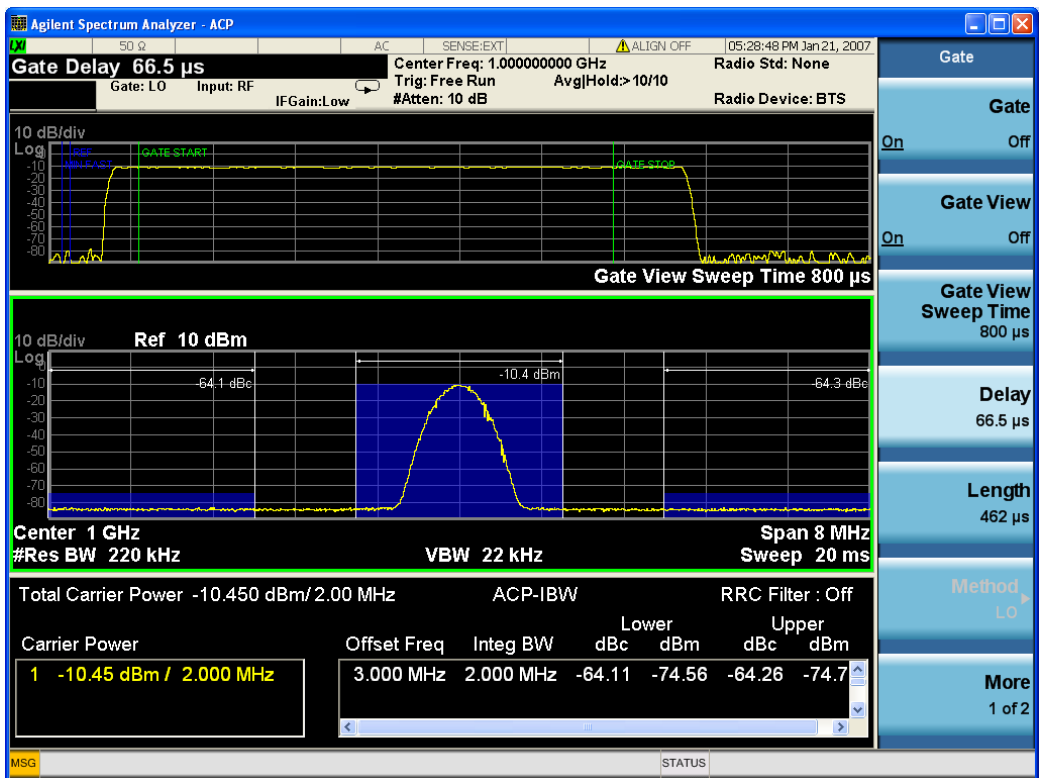

Turning Gate View off returns the analyzer to the Normal measurement view.

In the Swept SA, the normal measurement view is the single-window Swept SA view. When returning to this view, the Swept SA measurement returns to the Span it was in before entering **Gate View** (even if that is Zero Span).

The **Gate View** window is triggered from the Gate Source, with zero trigger delay. Also, when updating the **Gate View** window, the Gate itself must not operate. So it is internally shut off while the gate view window is being updated. For the Swept SA measurement, this means that the Gate is internally shut off whenever the gate view window is displayed. The measurement bar and softkeys continue to show the Trigger source for the main sweep window and give no indication that the Gate is shut off or that the Gate View window is triggered from the Gate Source.

When in **Gate View**, vertical lines are displayed in the Gate View window as follows:

- Green lines are displayed at the gate edges as follows: in Edge Gate, a line is shown for Delay and one for the end of the Gate period, defined by Length. You can adjust the position of the green lines by adjusting the gate length and the gate delay. These lines update in the Gate View window as the active function changes, even if the window is not being updated. In Gated FFT, their location is relative to the left edge of the screen.
- A blue line is displayed showing the delay reference, that is, the reference point for the Gate Delay within the Zero Span window. The blue line represents where (in time) the effective location of the gate start would be if the gate were programmed to zero delay.

-

Gate View Setup

Accesses a menu that enables you to setup parameters relevant to the Gate View

Key Path	Sweep/Control, Gate
Scope	Meas Global
Initial S/W Revision	A.10.00

Gate View Acquisition Time

Controls the acquisition time in the Gate View window. To provide an optimal view of the gate signal, the analyzer initializes Gate View Acq Time based on the current settings of Gate Delay and Gate Length.

Key Path	Sweep/Control, Gate, Gate View Setup
Remote Command	[:SENSe] :SWEep:EGATe:TIME <time> [:SENSe] :SWEep:EGATe:TIME?
Example	SWE:EGAT:TIME 500 ms
Dependencies	Gate View Acquisition Time is initialized: <ul style="list-style-type: none"> • On Preset (after initializing delay and length). • Every time the Gate Method is set/changed. <ol style="list-style-type: none"> 1. Compute the location of the "gate stop" line, which you know is at time $t = t_{min} + GateDelay +$

GateLength.	
Preset	519.3 μ s WiMAX OFDMA: 5 ms GSM/EDGE: 1 ms
State Saved	Saved in instrument state
Min	100 ns
Max	6000 s
Initial S/W Revision	Prior to A.02.00

Gate View Start Time

Controls the time at the left edge of the Gate View.

Key Path	Sweep/Control, Gate, Gate View Setup
Remote Command	[:SENSe] :SWEep:EGATe:VIEW:STARt <time> [:SENSe] :SWEep:EGATe:VIEW:STARt?
Example	SWE:EGAT:VIEW:STAR 10ms
Notes	Units of time are required or no units; otherwise an invalid suffix error message will be generated. See error -131.
Preset	0 ms
State Saved	Saved in instrument state
Min	0
Max	500 ms
Initial S/W Revision	A.10.00

Gate Delay

Controls the length of time from the time the gate condition goes True until the gate is turned on.

Key Path	Sweep/Control, Gate
Remote Command	[:SENSe] :SWEep:EGATe:DELay <time> [:SENSe] :SWEep:EGATe:DELay?
Example	SWE:EGAT:DELay 500ms SWE:EGAT:DELay?
Notes	Units of time are required or no units; otherwise an invalid suffix error message will be generated.
Preset	57.7 us WiMAX OFDMA: 71 us GSM/EDGE: 600 us

	WLAN: 500 us WLAN: 36 us
State Saved	Saved in instrument state
Min	0.0 us
Max	100 s
Backwards Compatibility SCPI	[:SENSe]:SWEep:TIME:GATE:DELay ESA compatibility
Initial S/W Revision	Prior to A.02.00

Gate Length

Controls the length of time that the gate is on after it opens.

Key Path	Sweep/Control, Gate
Remote Command	[:SENSe]:SWEep:EGATe:LENGth <time> [:SENSe]:SWEep:EGATe:LENGth?
Example	SWE:EGAT:LENG 1 SWE:EGAT:LENG?
Notes	Units of time are required or no units; otherwise an invalid suffix error message will be generated.
Preset	461.6 us WiMAX OFDMA: 50 us GSM/EDGE: 200 us WLAN: 1.54 ms WLAN: 32 us
State Saved	Saved in instrument state
Min	100 ns
Max	5 s
Backwards Compatibility SCPI	[:SENSe]:SWEep:TIME:GATE:LENGth ESA compatibility
Initial S/W Revision	Prior to A.02.00

Gate Source

The menus under the Gate Source key are the same as those under the Trigger key, with the exception that neither Free Run nor Video are available as Gate Source selections. However, a different SCPI command is used to select the Gate Source (see table below) because you may independently set the Gate Source and the Trigger Source.

Any changes to the settings in the setup menus under each Gate Source selection key (for example: Trigger Level, Trigger Delay, etc.) also affect the corresponding settings under the Trigger menu keys. The SCPI commands used for these are the same for Trigger and Gate, since there is only one setting which affects both Gate and Trigger. Example: to set the Trigger Level for External 1 you use the command :TRIG:EXT1:LEV regardless of whether you are using External 1 as a Trigger Source or a Gate Source.

Key Path	Sweep/Control, Gate
Remote Command	[:SENSe] :SWEep:EGATe:SOURce EXTernal1 EXTernal2 LINE FRAMe RFBurst [:SENSe] :SWEep:EGATe:SOURce?
Dependencies	In some models, there is no second External input. In these models, the External 2 key is blanked and the EXTernal2 parameter will generate a "Hardware missing; Not available for this model number" error.
Preset	EXTernal 1 GSM/EDGE, MSR: FRAMe LTETDD: EXTernal 1When Direction is Downlink, FRAMe when Direction is Uplink.
Initial S/W Revision	Prior to A.02.00
Modified at S/W Revision	A.03.00, A.14.00

Video (IF Envelope)

Pressing this key, when it is not selected, selects the video signal as the trigger. The Video trigger condition is met when the video signal (the filtered and detected version of the input signal, including both RBW and VBW filtering) crosses the video trigger level.

NOTE

When the detector selected for all active traces is the average detector, the video signal for triggering does not include any VBW filtering.

The video trigger level is shown as a labeled line on the display. The line is displayed as long as video is the selected trigger source.

Pressing this key, when it is already selected, accesses the video trigger setup functions.

Key Path	Trigger
Example	TRIG:SOUR VID Swept SA measurement TRIG:<meas>:SOUR VID Measurements other than Swept SA
Notes	Log Plot and Spot Frequency measurements do not support Video Trigger
Dependencies	Video trigger is allowed in average detector mode.
State Saved	Saved in instrument state
Status Bits/OPC dependencies	The Status Operation Register bit 5 "Waiting for Trigger" is set at the same time as the Sweeping or Measuring bit is set. It is cleared when the trigger actually occurs (that is, after the trigger event occurs and all the applicable trigger criteria have been met). A corresponding pop-up message ("Waiting for trigger") is generated if no trigger signal appears after approximately 2 sec. This message goes away when a trigger signal appears.

Backwards Compatibility Notes	In the past, the Average detector was not available when Video triggering was on, and consequently, functions that set the detector to average (such as Marker Noise or Band/Intvl Power) were not available when the video trigger was on. Similarly, Video triggering was not available when the detector was Average. In the X-Series, these restrictions are removed.
Initial S/W Revision	Prior to A.02.00

Trigger Level

Sets a level for the video signal trigger. When the video signal crosses this level, with the chosen slope, the trigger occurs. This level is displayed with a horizontal line only if **Video** is the selected trigger source.

Key Path	Trigger, Video
Remote Command	:TRIGger[:SEquence]:VIDeo:LEVel <ampl> :TRIGger[:SEquence]:VIDeo:LEVel?
Example	TRIG:VID:LEV -40 dBm
Notes	<p>When sweep type = FFT, the video trigger uses the amplitude envelope in a bandwidth wider than the FFT width as a trigger source. This might often be useful, but does not have the same relationship between the displayed trace and the trigger level as in swept triggering.</p> <p>Amplitude Corrections are not taken into account by the Video Trig Level. For example, if you have given yourself effective gain with an amplitude correction factor, the Video Trigger will not fire until you have dropped the trigger line that far below the displayed signal level, rather than simply dropping it down to the displayed signal level.</p> <p>Note that other corrections, specifically External Gain and Ref Level Offset, modify the actual trace data as it is taken and therefore ARE taken into account by Trig Level.</p>
Couplings	This same level is used for the Video trigger source in the Trigger menu and for the Video selection in the Gate Source menu.
Preset	Set the Video Trigger Level -25 dBm on Preset. When the Video Trigger Level becomes the active function, if the value is off screen, set it to either the top or bottom of screen, depending on which direction off screen it was.
State Saved	Saved in instrument state
Min	-170 dBm
Max	+30 dBm
Default Unit	Depends on the current selected Y axis unit
Backwards Compatibility SCPI	:TRIGger[:SEquence]:IF:LEVel :TRIGger[:SEquence]:IF:LEVel?
Backwards Compatibility Notes	This alias is provided for backward compatibility with VSA/PSA comms apps.
Initial S/W Revision	Prior to A.02.00

Trig Slope

Controls the trigger polarity. It is set positive to trigger on a rising edge and negative to trigger on a falling edge.

Key Path	Trigger, Video
Remote Command	:TRIGger[:SEquence]:VIDeo:SLOPe POSitive NEGative :TRIGger[:SEquence]:VIDeo:SLOPe?
Example	TRIG:VID:SLOP NEG
Preset	POSitive
State Saved	Saved in instrument state
Backwards Compatibility SCPI	:TRIGger[:SEquence]:IF:SLOPe NEGative POSitive :TRIGger[:SEquence]:IF:SLOPe? For backward compatibility with VSA/PSA comms apps
Backwards Compatibility Notes	The legacy :TRIGger[:SEquence]:SLOPe command affects the slopes for the VID, LINE, EXT1, EXT2, and RFB triggers.
Initial S/W Revision	Prior to A.02.00

Remote Command	:TRIGger[:SEquence]:SLOPe POSitive NEGative :TRIGger[:SEquence]:SLOPe?
Example	TRIG:SLOP NEG
Preset	POSitive
State Saved	Saved in instrument state
Backwards Compatibility Notes	In ESA/PSA, the Trigger Slope was global to all triggers. In the X-Series, the slope can be set individually for each Trigger Source. For backward compatibility, the global SLOPe command updates all instances of trigger slope (VID, LINE, EXT1, EXT2, TV, RFB). The query returns the trigger slope setting of the currently selected trigger source.
Initial S/W Revision	Prior to A.02.00

External 1

Pressing this key, when it is not selected, selects an external input signal as the trigger. A new sweep/measurement will start when the external trigger condition is met using the external 1 input connector on the rear panel.

Pressing this key, when it is already selected, accesses the external 1 trigger setup menu.

Key Path	Trigger
Example	TRIG:SOUR EXT1 Swept SA measurement TRIG:<meas>:SOUR EXT1 Measurements other than Swept SA
Dependencies	Grayed out if in use by Point Trigger in the Source Setup menu. Forced to Free Run if already selected and Point Trigger is set to External 1.

State Saved	Saved in instrument state
Status Bits/OPC dependencies	The Status Operation Register bit 5 "Waiting for Trigger" is set at the same time as the Sweeping or Measuring bit is set. It is cleared when the trigger actually occurs (that is, after the trigger event occurs and all the applicable trigger criteria have been met). A corresponding pop-up message ("Waiting for trigger") is generated if no trigger signal appears after approximately 2 sec. This message goes away when a trigger signal appears.
Initial S/W Revision	Prior to A.02.00

Trigger Level

Sets the value where the external 1 trigger input will trigger a new sweep/measurement.

Key Path	Trigger, External 1
Remote Command	:TRIGger[:SEquence]:EXTernal1:LEVel <level> :TRIGger[:SEquence]:EXTernal1:LEVel?
Example	TRIG:EXT1:LEV 0.4 V
Couplings	This same level is used for the Ext1 trigger source in the Trigger menu, for the Ext1 selection in the Periodic Timer sync source (in the Trigger menu and in the Gate Source menu), and also for the Ext1 selection in the Gate Source menu.
Preset	1.2 V
State Saved	Saved in instrument state
Min	-3.5V
Max	3.5V
Default Unit	V
Backwards Compatibility SCPI	:TRIGger[:SEquence]:EXTernal:LEVel For backward compatibility, the parameter EXTernal is mapped to EXTernal1
Backwards Compatibility SCPI	:TRIGger[:SEquence]:FRAMe:EXTernal1:LEVel
Initial S/W Revision	Prior to A.02.00

Trig Slope

Controls the trigger polarity. It is set positive to trigger on a rising edge and negative to trigger on a falling edge.

Key Path	Trigger, External 1
Remote Command	:TRIGger[:SEquence]:EXTernal1:SLOPe POSitive NEGative :TRIGger[:SEquence]:EXTernal1:SLOPe?

Example	TRIG:EXT1:SLOP NEG
Couplings	This same slope is used in the Ext1 selection for the trigger source in the Trigger menu and for the period timer sync source (in the Trigger menu and in the Gate Source menu).
Preset	POSitive
State Saved	Saved in instrument state
Backwards Compatibility SCPI	:TRIGger[:SEQuence]:EXTernal:SLOPe For backward compatibility, the parameter EXTernal is mapped to EXTernal1
Backwards Compatibility SCPI	:TRIGger[:SEQuence]:FRAMe:EXTernal1:SLOPe
Backwards Compatibility Notes	The legacy :TRIGger[:SEQuence]:SLOPe command affects the slopes for the VID, LINE, EXT1, EXT2, and RFB triggers.
Initial S/W Revision	Prior to A.02.00

Zero Span Delay Comp On/Off

In zero span, there is a natural delay in the signal path, which comes from the RBW filter. This is usually desirable, as it allows you to trigger on events and also see those events, because the signal is delayed from the trigger event. However, in some cases it is desirable to eliminate this delay, so that trigger events line up exactly with the zero time point in zero span. You can use the Zero Span Delay Comp On/Off feature to enable or disable zero span delay compensation.

Key Path	Trigger, External 1
Remote Command	:TRIGger[:SEQuence]:EXTernal1:DELAy:COMPensation OFF ON 0 1 :TRIGger[:SEQuence]:EXTernal1:DELAy:COMPensation?
Example	TRIG:EXT1:DEL:COMP ON
Dependencies	No effect except in zero-span, but not locked out in nonzero spans. Blanked in modes that do not support zero-span measurements. If the SCPI command is sent when the key is blanked, an error is returned: -221, "Settings conflict; Feature not supported for this measurement" In analyzers shipping N9060A, this feature requires N9060A-7FP.
Preset	OFF
State Saved	Saved in instrument state
Initial S/W Revision	A.11.00

External 2

Pressing this key, when it is not selected, selects an external input signal as the trigger. A new sweep/measurement will start when the external trigger condition is met using the external 2 input connector. The external trigger 2 input connector is on the rear panel.

Pressing this key, when it is already selected, accesses the external 2 trigger setup menu.

Key Path	Trigger
Example	TRIG:SOUR EXT2 Swept SA measurement TRIG:<meas>:SOUR EXT2 Measurements other than Swept SA
Dependencies	In some models, there is no second External input. In these models, the External 2 key is blanked and the EXTERNAL2 parameter will generate a "Hardware missing; Not available for this model number" message. Grayed out if in use by Point Trigger in the Source Setup menu. Forced to Free Run if already selected and Point Trigger is set to External 2.
State Saved	Saved in instrument state
Status Bits/OPC dependencies	The Status Operation Register bit 5 "Waiting for Trigger" is set at the same time as the Sweeping or Measuring bit is set. It is cleared when the trigger actually occurs (that is, after the trigger event occurs and all the applicable trigger criteria have been met). A corresponding pop-up message ("Waiting for trigger") is generated if no trigger signal appears after approximately 2 sec. This message goes away when a trigger signal appears.
Initial S/W Revision	Prior to A.02.00
Modified at S/W Revision	A.03.00

Trigger Level

Sets the value where the external 2 trigger input will trigger a new sweep/measurement.

Key Path	Trigger, External 2
Remote Command	:TRIGger[:SEquence]:EXTernal2:LEVel :TRIGger[:SEquence]:EXTernal2:LEVel?
Example	TRIG:EXT2:LEV 1.1 V
Couplings	This same level is used for the Ext2 trigger source in the Trigger menu, for the Ext2 selection in the Periodic Timer sync source (in the Trigger menu and in the Gate Source menu), and also for the Ext2 selection in the Gate Source menu.
Preset	1.2 V
State Saved	Saved in instrument state
Min	-3.5V
Max	3.5V
Default Unit	V
Backwards Compatibility SCPI	:TRIGger[:SEquence]:FRAME:EXTernal2:LEVel
Initial S/W Revision	Prior to A.02.00

Trig Slope

Controls the trigger polarity. It is set positive to trigger on a rising edge and negative to trigger on a falling edge.

Key Path	Trigger, External 2
Remote Command	:TRIGger[:SEquence]:EXTernal2:SLOPe POSitive NEGative :TRIGger[:SEquence]:EXTernal2:SLOPe?
Example	TRIG:EXT2:SLOP NEG
Couplings	This same slope is used in the Ext2 selection for the trigger source in the Trigger menu and for the period timer sync source (in the Trigger menu and in the Gate Source menu).
Preset	POSitive
State Saved	Saved in instrument state
Backwards Compatibility SCPI	:TRIGger[:SEquence]:FRAMe:EXTernal2:SLOPe
Backwards Compatibility Notes	The legacy :TRIGger[:SEquence]:SLOPe command affects the slopes for the VID, LINE, EXT1, EXT2, and RFB triggers.
Initial S/W Revision	Prior to A.02.00

Zero Span Delay Comp On/Off

In zero span, there is a natural delay in the signal path, which comes from the RBW filter. This is usually desirable, as it allows you to trigger on events and also see those events, because the signal is delayed from the trigger event. However, in some cases it is desirable to eliminate this delay, so that trigger events line up exactly with the zero time point in zero span. You can use the Zero Span Delay Comp On/Off feature to enable or disable zero span delay compensation.

Key Path	Trigger, External 2
Remote Command	:TRIGger[:SEquence]:EXTernal2:DELAy:COMPensation OFF ON 0 1 :TRIGger[:SEquence]:EXTernal2:DELAy:COMPensation?
Example	TRIG:EXT2:DEL:COMP ON
Dependencies	No effect except in zero-span, but not locked out in nonzero spans. Blanked in modes that do not support zero-span measurements. If the SCPI command is sent when the key is blanked, an error is returned: -221, "Settings conflict; Feature not supported for this measurement" In analyzers shipping N9060A, this feature requires N9060A-7FP.
Preset	OFF
State Saved	Saved in instrument state
Initial S/W Revision	A.11.00

RF Burst

Pressing this key, when it is not selected, selects the RF Burst as the trigger. A new sweep/measurement will start when an RF burst envelope signal is identified from the signal at the RF Input connector. Pressing this key, when it is already selected, accesses the RF Burst trigger setup menu.

In some models, a variety of burst trigger circuitry is available, resulting in various available burst trigger bandwidths. The analyzer automatically chooses the appropriate trigger path based on the hardware configuration and other settings of the analyzer.

Key Path	Trigger
Example	TRIG:SOUR RFB Swept SA measurement TRIG:< meas>:SOUR RFB Measurements other than Swept SA
State Saved	Saved in instrument state
Status Bits/OPC dependencies	The Status Operation Register bit 5 "Waiting for Trigger" is set at the same time as the Sweeping or Measuring bit is set. It is cleared when the trigger actually occurs (that is, after the trigger event occurs and all the applicable trigger criteria have been met). A corresponding pop-up message ("Waiting for trigger") is generated if no trigger signal appears after approximately 2 sec. This message goes away when a trigger signal appears.
Backwards Compatibility Notes	The legacy command: :TRIGger[:SEQuence]:RFBurst:FSElectivity[:STATe] OFF ON 0 1 is not supported in the X-Series, as the hardware to do Frequency Selective burst triggers does not exist in X-Series.
Initial S/W Revision	Prior to A.02.00
Modified at S/W Revision	A.04.00

Absolute Trigger Level

Sets the absolute trigger level for the RF burst envelope.

When using the External Mixing path, the Absolute Trigger Level is uncalibrated because the factory default was set to accommodate the expected IF levels for the RF path.

Key Path	Trigger, RF Burst
Scope	Meas Global
Remote Command	:TRIGger[:SEQuence]:RFBurst:LEVel:ABSolute <ampl> :TRIGger[:SEQuence]:RFBurst:LEVel:ABSolute?
Example	TRIG:RFB:LEV:ABS 10 dBm sets the trigger level of the RF burst envelope signal to the absolute level of 10 dBm
Notes	Sending this command does not switch the setting from relative to absolute; to switch it you need to send the :TRIGger[:SEQuence]:RFBurst:LEVel:TYPE command, below. Amplitude Corrections are not taken into account by the Absolute Trigger Level. For example, if you have given yourself effective gain with an amplitude correction factor, the Absolute Trigger will not fire until you have set the trigger level that far below the displayed signal level, rather than simply to

	the displayed signal level. This is only true for Amplitude Corrections, not External Gain or Ref Level Offset functions. If mode is Bluetooth, the default value is -50 dBm.
Couplings	This same level is used for the RF Burst trigger source in the Trigger menu, for the RF Burst selection in the Periodic Timer sync source (in the Trigger menu and in the Gate Source menu), and also for the RF Burst selection in the Gate Source menu
Preset	-20 dBm
State Saved	Saved in instrument state
Min	-200 dBm
Max	100 dBm
Default Unit	depends on the current selected Y-Axis unit
Backwards Compatibility SCPI	:TRIGger[:SEquence]:FRAMe:RFBurst:LEVel:ABSolute
Initial S/W Revision	Prior to A.02.00
Modified at S/W Revision	A.04.00

Key Path	Trigger, RF Burst
Remote Command	:TRIGger[:SEquence]:RFBurst:LEVel:TYPE ABSolute RELative :TRIGger[:SEquence]:RFBurst:LEVel:TYPE?
Example	TRIG:RFB:LEV:TYPE REL sets the trigger level type of the RF burst trigger to Relative.
Preset	ABSolute
State Saved	Saved in instrument state
Initial S/W Revision	Prior to A.02.00
Modified at S/W Revision	A.04.00

Relative Trigger Level

Sets the relative trigger level for the RF burst envelope.

In some models, the relative burst trigger function is implemented in hardware. In other models, without the advanced triggering hardware required, the relative burst trigger function is implemented in software in some measurements, and is unavailable in other measurements.

When implemented in software, the relative RF Burst trigger function is implemented as follows:

1. The measurement starts with the absolute RF Burst trigger setting. If it cannot get a trigger with that level, auto trigger fires and the acquisition starts anyway. After the acquisition, the measurement searches for the peak in the acquired waveform and saves it.

2. Now, in the next cycle of the measurement, the measurement determines a new absolute RF Burst level based on the peak value from the first measurement and the Relative RF Burst Trigger Level (always 0 or negative dB) set by the user. The following formula is used:
 3. absolute RF Burst level = peak level of the previous acquisition + relative RF Burst level
 4. If the new absolute RF Burst level differs from the previous by more than 0.5 dB, the new level is sent to the hardware; otherwise it is not updated (to avoid slowing down the acquisition)
- Steps 2 and 3 repeat for subsequent measurements.

Key Path	Trigger, RF Burst
Scope	Meas Global
Remote Command	:TRIGger[:SEquence]:RFBurst:LEVel:RELative <rel_ampl> :TRIGger[:SEquence]:RFBurst:LEVel:RELative?
Example	TRIG:RFB:LEV:REL -10 dB sets the trigger level of the RF burst envelope signal to the relative level of -10 dB
Notes	Sending this command does not switch the setting from absolute to relative; to switch it you need to send the :TRIGger[:SEquence]:RFBurst:LEVel:TYPE command, above. The relative trigger level is not available in some measurements. In those measurements the RELative parameter, and the :TRIGger[:SEquence]:RFBurst:LEVel:TYPE command (above), will generate an error if sent.
Dependencies	This key is grayed out and Absolute Trigger Level selected if the required hardware is not present in your analyzer and the current measurement does not support Relative triggering.
Preset	-6 dB GSM: -25 dB
State Saved	Saved in instrument state
Min	-45 dB
Max	0 dB
Default Unit	dB or dBc
Backwards Compatibility SCPI	:TRIGger[:SEquence]:RFBurst:LEVel This legacy command is aliased to :TRIGger[:SEquence]:RFBurst:LEVel:RELative because the PSA had ONLY relative burst triggering
Initial S/W Revision	Prior to A.02.00
Modified at S/W Revision	A.04.00

Trigger Slope

It is set positive to trigger on a rising edge and negative to trigger on a falling edge.

Key Path	Trigger, RF Burst
Remote Command	:TRIGger[:SEquence]:RFBurst:SLOPe POSitive NEGative :TRIGger[:SEquence]:RFBurst:SLOPe?

Example	TRIG:RFB:SLOP NEG
Couplings	This same slope is used in the RF Burst selection for the trigger source in the Trigger menu and for the period timer sync source (in the Trigger menu and in the Gate Source menu).
Preset	POSitive
State Saved	Saved in instrument state
Backwards Compatibility SCPI	:TRIGger[:SEQuence]:FRAMe:RFBurst:SLOPe
Backwards Compatibility Notes	The legacy :TRIGger[:SEQuence]:SLOPe command affects the slopes for the VID, LINE, EXT1, EXT2, and RFB triggers.
Initial S/W Revision	Prior to A.02.00

Periodic Timer (Frame Trigger)

Pressing this key, when it is not selected, selects the internal periodic timer signal as the trigger. Triggering occurrences are set by the **Period** parameter, which is modified by the **Sync Source** and **Offset**. Pressing this key, when it is already selected, accesses the periodic timer trigger setup functions.

If you do not have a sync source selected (it is Off), then the internal timer will not be synchronized with any external timing events.

Key Path	Trigger
Example	TRIG:SOUR FRAM Swept SA measurement TRIG:<meas>:SOUR FRAM Measurements other than Swept SA
State Saved	Saved in instrument state
Readback	[Sync: <value of Sync Source>], for example, [Sync: External 1]
Status Bits/OPC dependencies	The Status Operation Register bit 5 "Waiting for Trigger" is set at the same time as the Sweeping or Measuring bit is set. It is cleared when the trigger actually occurs (that is, after the trigger event occurs and all the applicable trigger criteria have been met). A corresponding pop-up message ("Waiting for trigger") is generated if no trigger signal appears after approximately 2 sec. This message goes away when a trigger signal appears.
Initial S/W Revision	Prior to A.02.00

Periodic Timer Triggering:

This feature selects the internal periodic timer signal as the trigger. Trigger occurrences are set by the **Periodic Timer** parameter, which is modified by the **Sync Source** and **Offset**.

The figure below shows the action of the periodic timer trigger. Before reviewing the figure, we'll explain some uses for the periodic trigger.

A common application is measuring periodic burst RF signals for which a trigger signal is not easily available. For example, we might be measuring a TDMA radio which bursts every 20 ms. Let's assume that the 20 ms period is very consistent. Let's also assume that we do not have an external trigger source

available that is synchronized with the period, and that the signal-to-noise ratio of the signal is not high enough to provide a clean RF burst trigger at all of the analysis frequencies. For example, we might want to measure spurious transmissions at an offset from the carrier that is larger than the bandwidth of the RF burst trigger. In this application, we can set the Periodic Timer to a 20.00 ms period and adjust the offset from that timer to position our trigger just where we want it. If we find that the 20.00 ms is not exactly right, we can adjust the period slightly to minimize the drift between the period timer and the signal to be measured.

A second way to use this feature would be to use **Sync Source** temporarily, instead of **Offset**. In this case, we might tune to the signal in a narrow span and use the RF Burst trigger to synchronize the periodic timer. Then we would turn the sync source off so that it would not miss-trigger. Miss-triggering can occur when we are tuned so far away from the RF burst trigger that it is no longer reliable.

A third example would be to synchronize to a signal that has a reference time element of much longer period than the period of interest. In some CDMA applications, it is useful to look at signals with a short periodicity, by synchronizing that periodicity to the "even-second clock" edge that happens every two seconds. Thus, we could connect the even-second clock trigger to Ext1 and use then Ext1 as the sync source for the periodic timer.

The figure below illustrates this third example. The top trace represents the even-second clock. It causes the periodic timer to synchronize with the leading edge shown. The analyzer trigger occurs at a time delayed by the accumulated offset from the period trigger event. The periodic timer continues to run, and triggers continue to occur, with a periodicity determined by the analyzer time base. The timer output (labeled "late event") will drift away from its ideal time due to imperfect matching between the time base of the signal being measured and the time base of the analyzer, and also because of imperfect setting of the period parameter. But the synchronization is restored on the next even-second clock event. ("Accumulated offset" is described in the in the **Offset** function section.)

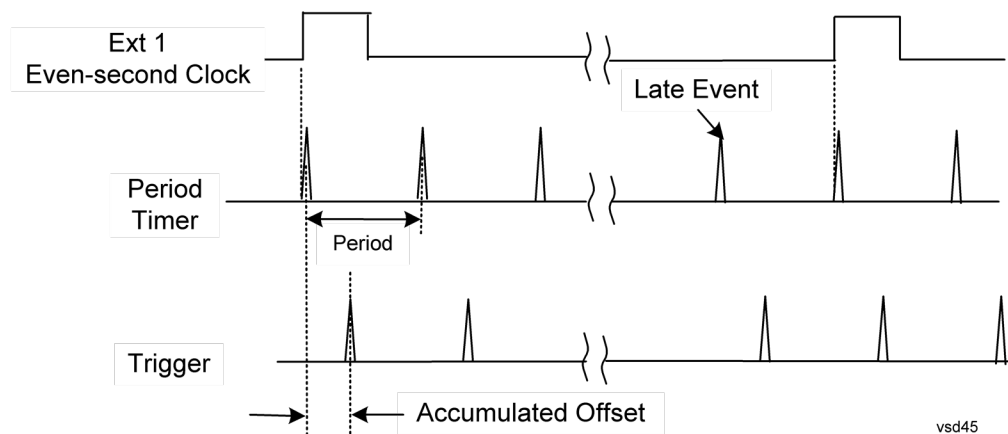

Period

Sets the period of the internal periodic timer clock. For digital communications signals, this is usually set to the frame period of your current input signal. In the case that sync source is not set to OFF, and the external sync source rate is changed for some reason, the periodic timer is synchronized at the every external synchronization pulse by resetting the internal state of the timer circuit.

Key Path	Trigger, Periodic Timer
Remote Command	:TRIGger[:SEquence]:FRAMe:PERIod <time>

	:TRIGger[:SEquence]:FRAMe:PERiod?
Example	TRIG:FRAM:PER 100 ms
Dependencies	The invalid data indicator turns on when the period is changed, until the next sweep/measurement completes.
Couplings	The same period is used in the Gate Source selection of the period timer.
Preset	20 ms GSM: 4.615383
State Saved	Saved in instrument state
Min	100.000 ns
Max	559.0000 ms
Default Unit	S
Initial S/W Revision	Prior to A.02.00

Offset

Adjusts the accumulated offset between the periodic timer events and the trigger event. Adjusting the accumulated offset is different than setting an offset, and requires explanation.

The periodic timer is usually not synchronized with any external events, so the timing of its output events has no absolute meaning. Since the timing relative to external events (RF signals) is important, you need to be able to adjust (offset) it. However, you have no direct way to see when the periodic timer events occur. All that you can see is the trigger timing. When you want to adjust the trigger timing, you will be changing the internal offset between the periodic timer events and the trigger event. Because the absolute value of that internal offset is unknown, we will just call that the accumulated offset. Whenever the Offset parameter is changed, you are changing that accumulated offset. You can reset the displayed offset using Reset Offset Display. Changing the display does not change the value of the accumulated offset, and you can still make additional changes to accumulated offset.

To avoid ambiguity, we define that an increase in the "offset" parameter, either from the knob or the SCPI adjust command, serves to delay the timing of the trigger event.

Key Path	Trigger, Periodic Timer
Remote Command	:TRIGger[:SEquence]:FRAMe:OFFSet <time> :TRIGger[:SEquence]:FRAMe:OFFSet?
Example	TRIG:FRAM:OFFS 1.2 ms
Notes	The front panel interface (for example, the knob), and this command, adjust the accumulated offset, which is shown on the active function display. However, the actual amount sent to the hardware each time the offset is updated is the delta value, that is, the current accumulated offset value minus the previous accumulated offset value. Note that the accumulated offset value is essentially arbitrary; it represents the accumulated offset from the last time the offset was zeroed (with the Reset Offset Display key). Note that this command does not change the period of the trigger waveform. Note also that Offset is used only when the sync source is set to OFF, otherwise delay is used, see section "Trig Delay" on page 280.

	An increase in the "offset" parameter, either from the knob or the SCPI adjust command, serves to delay the timing of the trigger event.
Notes	When the SCPI command is sent the value shown on the key (and the Active Function, if this happens to be the active function) is updated with the new value. However, the actual amount sent to the hardware is the delta value, that is, the current accumulated offset value minus the previous accumulated offset value. The SCPI query simply returns the value currently showing on the key.
Dependencies	The invalid data indicator turns on when the offset is changed, until the next sweep/measurement completes.
Couplings	The same offset is used in the Gate Source selection of the period timer.
Preset	0 s
State Saved	Saved in instrument state
Min	-10.000 s
Max	10.000 s
Default Unit	S
Initial S/W Revision	Prior to A.02.00

Offset Adjust (Remote Command Only)

This remote command does not work at all like the related front panel keys. This command lets you advance the phase of the frame trigger by the amount you specify.

It does not change the period of the trigger waveform. If the command is sent multiple times, it advances the phase of the frame trigger an additional amount each time it is sent. Negative numbers are permitted.

Remote Command	:TRIGger[:SEquence]:FRAMe:ADJust <time>
Example	TRIG:FRAM:ADJ 1.2 ms
Notes	Note also that Offset is used only when the sync source is set to OFF, otherwise delay is used, see section " Trig Delay " on page 280 An increase in the "offset" parameter, either from the knob or the SCPI adjust command, serves to delay the timing of the trigger event.
Notes	The front panel interface (for example, the knob) and the :TRIG:FRAM:OFFS command adjust the accumulated offset, which is shown on the active function display. However, the actual amount sent to the hardware is the delta value, that is, the current offset value minus the previous offset value. When the SCPI command is sent the value shown on the key (and the Active Function, if this happens to be the active function) is updated by increasing it (or decreasing it if the value sent is negative) by the amount specified in the SCPI command. This is a "command only" SCPI command, with no query.
Dependencies	The invalid data indicator turns on when the offset is changed, until the next sweep/measurement completes.
Couplings	The same offset is used in the Gate Source selection of the period timer.
Preset	0 s

State Saved	Saved in instrument state
Min	-10.000 s
Max	10.000 s
Default Unit	S
Initial S/W Revision	Prior to A.02.00

Reset Offset Display

Resets the value of the periodic trigger offset display setting to 0.0 seconds. The current displayed trigger location may include an offset value defined with the Offset key. Pressing this key redefines the currently displayed trigger location as the new trigger point that is 0.0 s offset. The Offset key can then be used to add offset relative to this new timing.

Key Path	Trigger, Periodic Timer
Remote Command	:TRIGger[:SEquence]:FRAMe:OFFSet:DISPlay:RESet
Example	TRIG:FRAM:OFFS:DISP:RES
Initial S/W Revision	Prior to A.02.00

Sync Source

Selects a signal source for you to synchronize your periodic timer trigger to, otherwise you are triggering at some arbitrary location in the frame. Synchronization reduces the precision requirements on the setting of the period.

For convenience you may adjust the level and slope of the selected sync source in a conditional branch setup menu accessed from the Sync Source menu. Note that these settings match those in the **Trigger** and **Gate Source** menus; that is, each trigger source has only one value of level and slope, regardless of which menu it is accessed from.

Key Path	Trigger, Periodic Timer
Remote Command	:TRIGger[:SEquence]:FRAMe:SYNC EXTernal1 EXTernal2 RFBurst OFF :TRIGger[:SEquence]:FRAMe:SYNC?
Example	TRIG:FRAM:SYNC EXT2
Dependencies	In some models, there is no second External input. In these models, the External 2 key is blanked and the EXTernal2 parameter will generate a "Hardware missing; Not available for this model number" message.
Preset	Off GSM/EDGE, MSR,LTE,LTETDD: RFBurst
State Saved	Saved in instrument state
Readback	The current setting is read back to this key and it is also Readback to the previous Periodic Timer trigger key.

Backwards Compatibility SCPI	:TRIGger[:SEquence]:FRAMe:SYNC EXTernal
Initial S/W Revision	Prior to A.02.00
Modified at S/W Revision	A.03.00, A.14.00

Off

Turns off the sync source for your periodic trigger. With the sync source off, the timing will drift unless the signal source frequency is locked to the analyzer frequency reference.

Key Path	Trigger, Periodic Timer, Sync Source
Example	TRIG:FRAM:SYNC OFF
Readback	Off
Initial S/W Revision	Prior to A.02.00

External 1

Pressing this key, when it is not selected, selects an external input signal as the trigger. A new sweep/measurement will start when the external trigger condition is met using the external 1 input connector on the rear panel.

Pressing this key, when it is already selected, accesses the external 1 trigger setup menu.

Key Path	Trigger
Example	TRIG:SOUR EXT1 Swept SA measurement TRIG:<meas>:SOUR EXT1 Measurements other than Swept SA
Dependencies	Grayed out if in use by Point Trigger in the Source Setup menu. Forced to Free Run if already selected and Point Trigger is set to External 1.
State Saved	Saved in instrument state
Status Bits/OPC dependencies	The Status Operation Register bit 5 "Waiting for Trigger" is set at the same time as the Sweeping or Measuring bit is set. It is cleared when the trigger actually occurs (that is, after the trigger event occurs and all the applicable trigger criteria have been met). A corresponding pop-up message ("Waiting for trigger") is generated if no trigger signal appears after approximately 2 sec. This message goes away when a trigger signal appears.
Initial S/W Revision	Prior to A.02.00

Trigger Level

Sets the value where the external 1 trigger input will trigger a new sweep/measurement.

Key Path	Trigger, External 1
Remote Command	:TRIGger[:SEquence]:EXTernal1:LEVel <level> :TRIGger[:SEquence]:EXTernal1:LEVel?
Example	TRIG:EXT1:LEV 0.4 V
Couplings	This same level is used for the Ext1 trigger source in the Trigger menu, for the Ext1 selection in the Periodic Timer sync source (in the Trigger menu and in the Gate Source menu), and also for the Ext1 selection in the Gate Source menu.
Preset	1.2 V
State Saved	Saved in instrument state
Min	-3.5V
Max	3.5V
Default Unit	V
Backwards Compatibility SCPI	:TRIGger[:SEquence]:EXTernal:LEVel For backward compatibility, the parameter EXTernal is mapped to EXTernal1
Backwards Compatibility SCPI	:TRIGger[:SEquence]:FRAMe:EXTernal1:LEVel
Initial S/W Revision	Prior to A.02.00

Trig Slope

Controls the trigger polarity. It is set positive to trigger on a rising edge and negative to trigger on a falling edge.

Key Path	Trigger, External 1
Remote Command	:TRIGger[:SEquence]:EXTernal1:SLOPe POSitive NEGative :TRIGger[:SEquence]:EXTernal1:SLOPe?
Example	TRIG:EXT1:SLOP NEG
Couplings	This same slope is used in the Ext1 selection for the trigger source in the Trigger menu and for the period timer sync source (in the Trigger menu and in the Gate Source menu).
Preset	POSitive
State Saved	Saved in instrument state
Backwards Compatibility SCPI	:TRIGger[:SEquence]:EXTernal:SLOPe For backward compatibility, the parameter EXTernal is mapped to EXTernal1
Backwards Compatibility SCPI	:TRIGger[:SEquence]:FRAMe:EXTernal1:SLOPe
Backwards Compatibility Notes	The legacy :TRIGger[:SEquence]:SLOPe command affects the slopes for the VID, LINE, EXT1, EXT2, and RFB triggers.
Initial S/W Revision	Prior to A.02.00

External 2

Pressing this key, when it is not selected, selects an external input signal as the trigger. A new sweep/measurement will start when the external trigger condition is met using the external 2 input connector. The external trigger 2 input connector is on the rear panel.

Pressing this key, when it is already selected, accesses the external 2 trigger setup menu.

Key Path	Trigger
Example	TRIG:SOUR EXT2 Swept SA measurement TRIG:<meas>:SOUR EXT2 Measurements other than Swept SA
Dependencies	In some models, there is no second External input. In these models, the External 2 key is blanked and the EXTernal2 parameter will generate a "Hardware missing; Not available for this model number" message. Grayed out if in use by Point Trigger in the Source Setup menu. Forced to Free Run if already selected and Point Trigger is set to External 2.
State Saved	Saved in instrument state
Status Bits/OPC dependencies	The Status Operation Register bit 5 "Waiting for Trigger" is set at the same time as the Sweeping or Measuring bit is set. It is cleared when the trigger actually occurs (that is, after the trigger event occurs and all the applicable trigger criteria have been met). A corresponding pop-up message ("Waiting for trigger") is generated if no trigger signal appears after approximately 2 sec. This message goes away when a trigger signal appears.
Initial S/W Revision	Prior to A.02.00
Modified at S/W Revision	A.03.00

Trigger Level

Sets the value where the external 2 trigger input will trigger a new sweep/measurement.

Key Path	Trigger, External 2
Remote Command	:TRIGger[:SEquence]:EXTernal2:LEVel :TRIGger[:SEquence]:EXTernal2:LEVel?
Example	TRIG:EXT2:LEV 1.1 V
Couplings	This same level is used for the Ext2 trigger source in the Trigger menu, for the Ext2 selection in the Periodic Timer sync source (in the Trigger menu and in the Gate Source menu), and also for the Ext2 selection in the Gate Source menu.
Preset	1.2 V
State Saved	Saved in instrument state
Min	-3.5V
Max	

	3.5V
Default Unit	V
Backwards Compatibility SCPI	:TRIGger[:SEQuence]:FRAMe:EXTernal2:LEVel
Initial S/W Revision	Prior to A.02.00

Trig Slope

Controls the trigger polarity. It is set positive to trigger on a rising edge and negative to trigger on a falling edge.

Key Path	Trigger, External 2
Remote Command	:TRIGger[:SEQuence]:EXTernal2:SLOPe POSitive NEGative :TRIGger[:SEQuence]:EXTernal2:SLOPe?
Example	TRIG:EXT2:SLOP NEG
Couplings	This same slope is used in the Ext2 selection for the trigger source in the Trigger menu and for the period timer sync source (in the Trigger menu and in the Gate Source menu).
Preset	POSitive
State Saved	Saved in instrument state
Backwards Compatibility SCPI	:TRIGger[:SEQuence]:FRAMe:EXTernal2:SLOPe
Backwards Compatibility Notes	The legacy :TRIGger[:SEQuence]:SLOPe command affects the slopes for the VID, LINE, EXT1, EXT2, and RFB triggers.
Initial S/W Revision	Prior to A.02.00

RF Burst

Pressing this key, when it is not selected, selects the RF Burst as the trigger. A new sweep/measurement will start when an RF burst envelope signal is identified from the signal at the RF Input connector. Pressing this key, when it is already selected, accesses the RF Burst trigger setup menu.

In some models, a variety of burst trigger circuitry is available, resulting in various available burst trigger bandwidths. The analyzer automatically chooses the appropriate trigger path based on the hardware configuration and other settings of the analyzer.

Key Path	Trigger
Example	TRIG:SOUR RFB Swept SA measurement TRIG:<meas>:SOUR RFB Measurements other than Swept SA
State Saved	Saved in instrument state
Status Bits/OPC dependencies	The Status Operation Register bit 5 "Waiting for Trigger" is set at the same time as the Sweeping or Measuring bit is set. It is cleared when the trigger actually occurs (that is, after the trigger event)

	occurs and all the applicable trigger criteria have been met). A corresponding pop-up message ("Waiting for trigger") is generated if no trigger signal appears after approximately 2 sec. This message goes away when a trigger signal appears.
Backwards Compatibility Notes	The legacy command: :TRIGger[:SEquence]:RFBurst:FSElectivity[:STATe] OFF ON 0 1 is not supported in the X-Series, as the hardware to do Frequency Selective burst triggers does not exist in X-Series.
Initial S/W Revision	Prior to A.02.00
Modified at S/W Revision	A.04.00

Absolute Trigger Level

Sets the absolute trigger level for the RF burst envelope.

When using the External Mixing path, the Absolute Trigger Level is uncalibrated because the factory default was set to accommodate the expected IF levels for the RF path.

Key Path	Trigger, RF Burst
Scope	Meas Global
Remote Command	:TRIGger[:SEquence]:RFBurst:LEVel:ABSolute <ampl> :TRIGger[:SEquence]:RFBurst:LEVel:ABSolute?
Example	TRIG:RFB:LEV:ABS 10 dBm sets the trigger level of the RF burst envelope signal to the absolute level of 10 dBm
Notes	Sending this command does not switch the setting from relative to absolute; to switch it you need to send the :TRIGger[:SEquence]:RFBurst:LEVel:TYPE command, below. Amplitude Corrections are not taken into account by the Absolute Trigger Level. For example, if you have given yourself effective gain with an amplitude correction factor, the Absolute Trigger will not fire until you have set the trigger level that far below the displayed signal level, rather than simply to the displayed signal level. This is only true for Amplitude Corrections, not External Gain or Ref Level Offset functions. If mode is Bluetooth, the default value is -50 dBm.
Couplings	This same level is used for the RF Burst trigger source in the Trigger menu, for the RF Burst selection in the Periodic Timer sync source (in the Trigger menu and in the Gate Source menu), and also for the RF Burst selection in the Gate Source menu
Preset	-20 dBm
State Saved	Saved in instrument state
Min	-200 dBm
Max	100 dBm
Default Unit	depends on the current selected Y-Axis unit
Backwards Compatibility SCPI	:TRIGger[:SEquence]:FRAME:RFBurst:LEVel:ABSolute
Initial S/W Revision	Prior to A.02.00
Modified at S/W Revision	A.04.00

Key Path	Trigger, RF Burst
Remote Command	:TRIGger[:SEquence]:RFBurst:LEVel:TYPE ABSolute RELative :TRIGger[:SEquence]:RFBurst:LEVel:TYPE?
Example	TRIG:RFB:LEV:TYPE REL sets the trigger level type of the RF burst trigger to Relative.
Preset	ABSolute
State Saved	Saved in instrument state
Initial S/W Revision	Prior to A.02.00
Modified at S/W Revision	A.04.00

Trigger Slope

It is set positive to trigger on a rising edge and negative to trigger on a falling edge.

Key Path	Trigger, RF Burst
Remote Command	:TRIGger[:SEquence]:RFBurst:SLOPe POSitive NEGative :TRIGger[:SEquence]:RFBurst:SLOPe?
Example	TRIG:RFB:SLOP NEG
Couplings	This same slope is used in the RF Burst selection for the trigger source in the Trigger menu and for the period timer sync source (in the Trigger menu and in the Gate Source menu).
Preset	POSitive
State Saved	Saved in instrument state
Backwards Compatibility SCPI	:TRIGger[:SEquence]:FRAMe:RFBurst:SLOPe
Backwards Compatibility Notes	The legacy :TRIGger[:SEquence]:SLOPe command affects the slopes for the VID, LINE, EXT1, EXT2, and RFB triggers.
Initial S/W Revision	Prior to A.02.00

Sync Holdoff

Sync Holdoff specifies the duration that the sync source signal must be kept false before the transition to true to be recognized as the sync timing. The periodic timer phase is aligned when the sync source signal becomes true, after the Holdoff time is satisfied.

A holdoff of 2 ms will work with most WiMAX signals, but there may be cases where the burst off duration is less than 1 ms and this value will need to be changed.

Key Path	Trigger, Periodic Timer
Remote Command	:TRIGger[:SEquence]:FRAMe:SYNC:HOLDoFF <time> :TRIGger[:SEquence]:FRAMe:SYNC:HOLDoFF?

	<code>:TRIGger[:SEquence]:FRAMe:SYNC:HOLDoff:STATe OFF ON 0 1</code>
	<code>:TRIGger[:SEquence]:FRAMe:SYNC:HOLDoff:STATe?</code>
Preset	On, 1.000 ms
State Saved	Saved in instrument state
Min	0 ms
Max	+500 ms
Default Unit	s
Initial S/W Revision	Prior to A.02.00

Auto/Holdoff

Opens up a menu that lets you adjust Auto Trigger and Trigger Holdoff parameters

Key Path	Trigger
Readback line	Displays a summary of the Auto Trig and Holdoff settings, in square brackets First line: Auto Off or Auto On Second Line: "Hldf" followed by: <ul style="list-style-type: none"> • If Holdoff is Off, readback Off • If Holdoff On and Type = Normal, readback value • If Holdoff On and Type = Above, readback value followed by AL • If Holdoff On and Type = Below, readback value followed by BL • If Holdoff Type selection is not supported by the current measurement, Holdoff Type is always Normal
Initial S/W Revision	A.02.00

Auto Trig

Sets the time that the analyzer will wait for the trigger conditions to be met. If they are not met after that much time, then the analyzer is triggered anyway.

Key Path	Trigger, Auto/Holdoff
Remote Command	<code>:TRIGger[:SEquence]:ATRigger <time></code> <code>:TRIGger[:SEquence]:ATRigger?</code> <code>:TRIGger[:SEquence]:ATRigger:STATe OFF ON 0 1</code> <code>:TRIGger[:SEquence]:ATRigger:STATe?</code>
Example	TRIG:ATR:STAT ON TRIG:ATR 100 ms
Notes	The "time that the analyzer will wait" starts when the analyzer is ready for a trigger, which may be hundreds of ms after the data acquisition for a sweep is done. The "time" ends when the trigger condition is satisfied, not when the delay ends.

Preset	Off, 100 ms
State Saved	Saved in instrument state
Min	1 ms
Max	100 s
Default Unit	s
Initial S/W Revision	Prior to A.02.00

Trig Holdoff

Sets the holdoff time between triggers. When the trigger condition is satisfied, the trigger occurs, the delay begins, and the holdoff time begins. New trigger conditions will be ignored until the holdoff time expires. For a free-running trigger, the holdoff value is the minimum time between triggers.

Key Path	Trigger, Auto/Holdoff
Remote Command	:TRIGger[:SEquence]:HOLDoff <time> :TRIGger[:SEquence]:HOLDoff? :TRIGger[:SEquence]:HOLDoff:STATe OFF ON 0 1 :TRIGger[:SEquence]:HOLDoff:STATe?
Example	TRIG:HOLD:STAT ON TRIG:HOLD 100 ms
Dependencies	Unavailable if the selected Input is BBIQ. If this is the case, the key is grayed out if it is pressed the informational message "Feature not supported for this Input" is displayed. If the SCPI command is sent, the error "Settings conflict; Feature not supported for this Input" is generated.
Preset	Off, 100 ms
State Saved	Saved in instrument state
Min	0 s
Max	0.5 s
Default Unit	s
Initial S/W Revision	Prior to A.02.00

Gate Preset (Remote Command Only)

Presets the time-gated spectrum analysis capability.

This command sets gate parameter values to the ESA preset values, as follows:

Gate delay = 1 us

Gate length = 1 us

Remote Command	[:SENSe]:SWEep:TIME:GATE:PRESet ESA Compatibility
Initial S/W Revision	Prior to A.02.00

Gate Level (Remote Command Only)

Sets the gate input transition point level for the external TRIGGER inputs on the front and rear panel. This is a legacy command for PSA compatibility. It is simply an alias to the equivalent trigger level command.

Remote Command	<code>[:SENSe] :SWEep:EGATe:EXTeRnal [1] 2 :LEVe1 <voltage></code> <code>[:SENSe] :SWEep:EGATe:EXTeRnal [1] 2 :LEVe1 ?</code>
Notes	This command is simply an alias to <code>:TRIGger[:SEQuence]:EXTeRnal[1] 2:LEVe1</code> For details refer
Initial S/W Revision	Prior to A.02.00

Gate Polarity (Remote Command Only)

Sets the polarity for the gate signal. This setup is now done using the gate trigger's slope setting.

When Positive (Pos) is selected, a positive-going edge (Edge) or a high voltage (Level) will satisfy the gate condition, after the delay set with the Gate Delay key. When Negative (Neg) is selected, a negative-going edge (Edge) or a low voltage (Level) will satisfy the gate condition after the delay.

Remote Command	<code>[:SENSe] :SWEep:EGATe:POLarity NEGative POSitive</code> <code>[:SENSe] :SWEep:EGATe:POLarity ?</code>
Example	<code>SWE:EGAT:POL NEG</code> <code>SWE:EGAT:POL ?</code>
Preset	POSitive
State Saved	Saved in instrument state
Backwards Compatibility SCPI	<code>[:SENSe] :SWEep:TIME:GATE:POLarity</code> ESA compatibility
Initial S/W Revision	Prior to A.02.00

Remote Command	<code>[:SENSe] :SWEep:TIME:GATE:LEVe1 HIGH LOW</code> <code>[:SENSe] :SWEep:TIME:GATE:LEVe1 ?</code> ESA compatibility
Preset	HIGH
Initial S/W Revision	Prior to A.02.00

System

See "System" on page 189

Trace/Detector

Accesses a menu of functions that enable you to control trace and detector for the current measurement.

Key Path	Front-panel key
Initial S/W Revision	Prior to A.02.00

Trace Type

Allows you to select the type of trace for the current measurement. The menu contains a 1-of-N selection of the trace type (Clear Write, Average, Max Hold, Min Hold).

Key Path	Trace/Detector
Mode	SA, WCDMA, C2K, WIMAX OFDMA, TD-SCDMA, 1xEVDO, DTMB (CTTB), DVB-T/H, ISDB-T, CMMB, LTE, LTEFDD, Digital Cable TV, WLAN, MSR, LTEAFDD, LTEATDD
Remote Command	:TRACe:SEMask:TYPE WRITe AVERAge MAXHold MINHold :TRACe:SEMask:TYPE?
Example	TRAC:SEM:TYPE MINH TRAC:SEM:TYPE?
Notes	WRITe = Clear Write AVERAge = Average MAXHold = Maximum Hold MINHold = Minimum Hold
Couplings	When Detector setting is "Auto" ([:SENSe]:SEMask:DETECTOR:AUTO?), Detector ([:SENSe]:SEMask:DETECTOR[:FUNCTION]?) switches aligning with the switch of this parameter: "NORMal" with WRITe (Clear Write), "AVERAge" with AVERAge, "POSitive (peak)" with MAXHold, and "NEGative (peak)" with MINHold.
Preset	AVERAge
State Saved	Saved in instrument state.
Range	WRITe AVERAge MAXHold MINHold
Initial S/W Revision	Prior to A.02.00
Modified at S/W Revision	A.02.00, A.03.00

Chan Detector

Accesses a menu of functions that enable you to control the detectors for reference channel. The following choices are available:

- Auto—the detector selected depends on marker functions, trace functions, average type, and the trace averaging function.
- Normal—the detector determines the peak of the CW-like signals, and it yields alternating maximums and minimums of noise-like signals. This is also referred to as Rosenfell detection.

- Average—the detector determines the average of the signal within the sweep points. The averaging method depends upon the Average Type selection (voltage, power or log scales).
- Peak—the detector determines the maximum of the signal within the sweep points.
- Sample—the detector indicates the instantaneous level of the signal at the center of the sweep points represented by each display point.
- Negative Peak—the detector determines the minimum of the signal within the sweep points.

Key Path	Trace/Detector
Initial S/W Revision	Prior to A.02.00

Chan Detector Auto

Sets the detector to the default detection mode for the reference channel. This mode is dependent upon the current reference channel conditions.

Key Path	Trace/Detector
Mode	SA, WCDMA, C2K, WIMAX OFDMA, TD-SCDMA, 1xEVDO, DTMB (CTTB), DVB-T/H, ISDB-T, CMMB, LTE, LTE-TDD, Digital Cable TV, WLAN, MSR, LTEAFDD, LTEATDD
Remote Command	[:SENSe] :SEMAsk:DETEctor:CARRier:AUTO ON OFF 1 0 [:SENSe] :SEMAsk:DETEctor:CARRier:AUTO?
Example	SEM:DET:CARR:AUTO OFF SEM:DET:CARR:AUTO?
Notes	See Couplings in the Trace Type section. You must be in the mode that includes SEM measurement to use this command. Use :INSTrument:SElect to set the mode.
Preset	ON
State Saved	Saved in instrument state
Range	On Off
Initial S/W Revision	Prior to A.02.00
Modified at S/W Revision	A.02.00, A.03.00

Chan Detector Selection

Selects the detector mode for the reference channel.

Key Path	Trace/Detector
Mode	SA, WCDMA, C2K, WIMAX OFDMA, TD-SCDMA, 1xEVDO, DTMB (CTTB), DVB-T/H, ISDB-T, CMMB, LTE, LTE-TDD, Digital Cable TV, WLAN, MSR, LTEAFDD, LTEATDD
Remote Command	[:SENSe] :SEMAsk:DETEctor:CARRier[:FUNction] AVERAge NEGative NORMal POSitive SAMPlE [:SENSe] :SEMAsk:DETEctor:CARRier[:FUNction]?

Example	SEM:DET:CARR NEG SEM:DET:CARR?
Notes	When you manually select a detector (instead of selecting Auto), that detector is used regardless of other analyzer settings. Note: This detector setting affects the reference channel. There is not a per trace detector. You must be in the mode that includes SEM measurement to use this command. Use :INSTrument:SElect to set the mode.
Couplings	See Couplings in the Trace Type section.
Preset	AVERage
State Saved	Saved in instrument state.
Range	Normal Average Peak Sample Negative Peak
Initial S/W Revision	Prior to A.02.00
Modified at S/W Revision	A.02.00, A.03.00

Offset Detector

Accesses a menu of functions that enable you to control the detector for offsets. The following choices are available.

- Auto– the detector selected depends on marker functions, trace functions, average type, and the trace averaging function.
- Normal–the detector determines the peak of the CW-like signals, and it yields alternating maximums and minimums of noise-like signals. This is also referred to as Rosenfell detection.
- Average–the detector determines the average of the signal within the sweep points. The averaging method depends upon the Average Type selection (voltage, power or log scales).
- Peak–the detector determines the maximum of the signal within the sweep points.
- Sample–the detector indicates the instantaneous level of the signal at the center of the sweep points represented by each display point.
- Negative Peak–the detector determines the minimum of the signal within the sweep points.

Key Path	Trace/Detector
Initial S/W Revision	Prior to A.02.00

Offset Detector Auto

Sets the detector to the default detection mode for the offsets. This mode is dependent upon the current signal conditions of the offsets.

Key Path	Trace/Detector
Mode	SA, WCDMA, C2K, WIMAX OFDMA, TD-SCDMA, 1xEVDO, DTMB (CTTB), DVB-T/H, ISDB-T, CMMB,

	LTE, LTE-TDD, Digital Cable TV, WLAN, MSR, LTEAFDD, LTEATDD
Remote Command	[:SENSe] :SEMAsk:DETEctor:OFFSet:AUTO ON OFF 1 0 [:SENSe] :SEMAsk:DETEctor:OFFSet:AUTO?
Example	SEM:DET:OFFS:AUTO OFF SEM:DET:OFFS:AUTO?
Notes	See Couplings in the Trace Type section. You must be in the mode that includes SEM measurement to use this command. Use :INSTrument:SElect to set the mode.
Preset	ON
State Saved	Saved in instrument state.
Range	On Off
Initial S/W Revision	Prior to A.02.00
Modified at S/W Revision	A.02.00, A.03.00

Offset Detector Selection

Selects the detector mode for the offsets.

Key Path	Trace/Detector
Mode	SA, WCDMA, C2K, WIMAX OFDMA, TD-SCDMA, 1xEVDO, DTMB (CTTB), DVB-T/H, ISDB-T, CMMB, LTE, LTE-TDD, Digital Cable TV, WLAN, MSR, LTEAFDD, LTEATDD
Remote Command	[:SENSe] :SEMAsk:DETEctor:OFFSet[:FUNctIon] AVERAge NEGAtive NORMAl POSitive SAMPlE [:SENSe] :SEMAsk:DETEctor:OFFSet[:FUNctIon]?
Example	SEM:DET:OFFS AVER SEM:DET:OFFS?
Notes	When you manually select a detector (instead of selecting Auto), that detector is used regardless of other analyzer settings. Note: This detector setting has effects all offsets. There is not a per trace detector. You must be in the mode that includes SEM measurement to use this command. Use :INSTrument:SElect to set the mode.
Couplings	See Couplings in the Trace Type section.
Preset	POSitive
State Saved	Saved in instrument state.
Range	Normal Average Peak Sample Negative Peak
Initial S/W Revision	Prior to A.02.00
Modified at S/W Revision	A.02.00, A.03.00

Trigger

See ["Trigger" on page 248](#)

Free Run

See ["Free Run " on page 255](#)

Video

See ["Video \(IF Envelope\) " on page 1440](#)

Trigger Level

See ["Trigger Level " on page 1440](#)

Trig Slope

See ["Trig Slope " on page 1441](#)

Trig Delay

See ["Trig Delay " on page 258](#)

External 1

See ["External 1 " on page 1454](#)

Trigger Level

See ["Trigger Level " on page 1455](#)

Trig Slope

See ["Trig Slope " on page 1455](#)

Trig Delay

See ["Trig Delay " on page 261](#)

Zero Span Delay Comp

See ["Zero Span Delay Comp On/Off " on page 1443](#)

External 2

See ["External 2 " on page 1456](#)

Trigger Level

See ["Trigger Level " on page 1457](#)

Trig Slope

See ["Trig Slope " on page 1457](#)

Trig Delay

See "Trig Delay " on page 264

Zero Span Delay Comp

See "Zero Span Delay Comp On/Off" on page 1446

RF Burst

See "RF Burst " on page 1458

Absolute Trigger

See "Absolute Trigger Level" on page 1458

Relative Trigger

See "Relative Trigger Level" on page 1448

Trig Slope

See "Trigger Slope " on page 1459

Trig Delay

See "Trig Delay " on page 268

Periodic Timer

See "Periodic Timer (Frame Trigger) " on page 1449

Period

See "Period " on page 1451

Offset

See "Offset " on page 1451

Offset Adjust (Remote Command Only)

See "Offset Adjust (Remote Command Only)" on page 1452

Reset Offset Display

See "Reset Offset Display " on page 1453

Sync Source

See "Sync Source " on page 1453

Off

See "Off " on page 1454

External 1

See ["External 1 "](#) on page 1454

Trigger Level

See ["Trigger Level "](#) on page 1455

Trig Slope

See ["Trig Slope "](#) on page 1455

External 2

See ["External 2 "](#) on page 1456

Trigger Level

See ["Trigger Level "](#) on page 1457

Trig Slope

See ["Trig Slope "](#) on page 1457

RF Burst

See ["RF Burst "](#) on page 1458

Absolute Trigger

See ["Absolute Trigger Level"](#) on page 1458

Trig Slope

See ["Trigger Slope "](#) on page 1459

Trig Delay

See ["Trig Delay"](#) on page 280

Auto/Holdoff

See ["Auto/Holdoff "](#) on page 1460

Auto Trig

See ["Auto Trig "](#) on page 1461

Trig Holdoff

See ["Trig Holdoff "](#) on page 1461

Internal

See ["Internal"](#) on page 282

User Preset

Accesses a menu that gives you the following three choices:

- User Preset – recalls a state previously saved using the Save User Preset function.
- User Preset All Modes – presets all of the modes in the analyzer
- Save User Preset– saves the current state for the current mode

NOTE

In products that run multiple instances of the X-Series Application, all instances use the same location to save User Preset state. So Save User Preset of one instance will overwrite the Save User Preset of another instance.

Key Path	Front-panel key
Backwards Compatibility Notes	<p>User Preset is actually loading a state, and in legacy analyzers, it was possible to load a state without affecting the trace data, limit lines or correction data. Similarly it was possible to do a User Preset without affecting the trace data, limit lines or correction data.</p> <p>In the X-Series, “state” always includes all of this data; so whenever state is loaded, or User Preset is executed, all of the traces, limit lines and corrections are affected. Although this differs from previous behavior, it is desirable behavior, and should not cause adverse issues for users.</p> <p>On ESA and PSA, User Preset affected the entire instrument’s state. In the X-Series, User Preset only recalls the state for the active mode. There is a User Preset file for each mode. User Preset can never cause a mode switch as it can in legacy analyzers. If you want to recall all modes to their user preset file state, you will need to do a User Preset after mode switching into each mode.</p> <p>User Preset recalls mode state which can now include data like traces; whereas on ESA and PSA, User Preset did not affect data.</p>
Initial S/W Revision	Prior to A.02.00

User Preset

User Preset sets the state of the currently active mode back to the state that was previously saved for this mode using the Save User Preset menu key or the SCPI command, SYST:PRES:USER:SAV. It not only recalls the Mode Preset settings, but it also recalls all of the mode persistent settings, and the Input/Output system setting that existed at the time Save User Preset was executed.

If a Save User Preset has not been done at any time, User Preset recalls the default user preset file for the currently active mode. The default user preset files are created if, at power-on, a mode detects there is no user preset file. There will never be a scenario when there is no user preset file to restore. For each mode, the default user preset state is the same state that would be saved if a Save User Preset is performed in each mode right after doing a Restore Mode Default and after a Restore Input/Output Defaults.

The User Preset function does the following:

- Aborts the currently running measurement.
- Sets the mode State to the values defined by Save User Preset.
- Makes the saved measurement for the currently running mode the active measurement.
- Brings up the saved menu for the power-on mode.

- Clears the input and output buffers.
- Sets the Status Byte to 0.

Key Path	User Preset
Remote Command	:SYSTem:PRESet:USER
Example	:SYST:PRES:USER:SAVE:SYST:PRES:USER
Notes	:SYST:PRES:USER:SAVE is used to save the current state as the user preset state. Clears all pending OPC bits. The Status Byte is set to 0. Pressing the User Preset front-panel key while already in the User Preset menu will cause the User Preset to get executed
Couplings	A user preset will cause the currently running measurement to be aborted and cause the saved measurement to be active. Recalling a User Preset file has the same issues that recalling a Save State file has. Some settings may need to be limited and therefore re-coupled, since the capabilities of the mode may have changes when the User Preset file was last saved.
Initial S/W Revision	Prior to A.02.00

User Preset All Modes

Recalls all of the User Preset files for each mode, switches to the power-on mode, and activates the saved measurement from the power-on mode User Preset file.

NOTE

When the instrument is secured, all of the user preset files are converted back to their default user preset files.

The User Preset function does the following:

- Aborts the currently running measurement.
- Switches the Mode to the power-on mode.
- Restores the User Preset files for each mode.
- Makes the saved measurement for the power-on mode the active measurement.
- Brings up the saved menu for the power-on mode.
- Clears the input and output buffers.
- Sets the Status Byte to 0.

Key Path	User Preset
Remote Command	:SYSTem:PRESet:USER:ALL
Example	:SYST:PRES:USER:SAVE:SYST:PRES:USER:ALL
Notes	Clears all pending OPC bits. The Status Byte is set to 0. :SYST:PRES:USER:SAVE is used to save the current state as the user preset state.
Couplings	A user preset will cause the currently running measurement to be aborted, cause a mode switch to the power-on mode, and cause the saved measurement to be active in the power-on mode.

Recalling a User Preset file has the same issues that recalling a Save State file has. Some settings may need to be limited and therefore re-coupled, since the capabilities of the mode may have changes when the User Preset file was last saved.

Initial S/W Revision Prior to A.02.00

Save User Preset

Saves the currently active mode and its State. You can recall this User Preset file by pressing the User Preset menu key or sending the SYST:PRES:USER remote command. This same state is also saved by the Save State function.

Key Path	User Preset
Remote Command	:SYSTem:PRESet:USER:SAVE
Example	:SYST:PRES:USER:SAVE
Notes	:SYST:PRES:SAVE creates the same file as if the user requested a *SAV or a MMEM:STOR:STAT, except User Preset Save does not allow the user to specify the filename or the location of the file.
Initial S/W Revision	Prior to A.02.00

View/Display

Accesses a menu of functions that enable you to control the instrument display.

The following keys select how the results are displayed:

- **Abs Pwr Freq**—displays the absolute power levels in dBm and the corresponding frequencies in the text window.
- **Rel Pwr Freq**—displays the relative power levels in dBc and the corresponding frequencies in the text window.
- **Integrated Power**—displays the absolute and relative power levels integrated throughout the bandwidths between the start and stop frequencies in the text window.
- **Carrier Info**—displays the carrier configuration information with measure powers. (Only available in MSR and LTE-Advanced FDD/TDD)

["View Selection by Name \(Remote Command Only\)" on page 1180](#)

["Views Selection by Number \(Remote Command only\)" on page 1181](#)

View Selection by Name (Remote Command Only)

Key Path	View/Display
Mode	SA, WCDMA, C2K, WIMAX OFDMA, TD-SCDMA, 1xEVDO, DTMB (CTTB), DVB-T/H, ISDB-T, CMMB, LTE, LTETDD, Digital Cable TV, WLAN, MSR, LTEAFDD, LTEATDD
Remote Command	:DISPlay:SEMask:VIEW[:SElect] APFReq RPFReq IPOWer CINformation :DISPlay:SEMask:VIEW[:SElect]?
Example	DISP:SEM:VIEW IPOW DISP:SEM:VIEW?
Notes	You must be in the mode that includes SEM measurement to use this command. Use :INSTrument:SElect to set the mode.
Dependencies	In the SA mode, when "Radio Standard" is set to WLAN, IPOWer is not available and the key is grayed out. CINformation is available only in MSR and LTE-Advanced FDD/TDD mode, otherwise the key is blank.
Preset	SA, , WCDMA, , C2K, , TD-SCDMA, , 1xEVDO, , DTMB (CTTB), , DVB-T/H, , ISDB-T, , CMMB, , LTE, , LTETDD, , Digital Cable TV, , MSR, , LTEAFDD, , LTEATDD: APFReq WIMAX OFDMA, WLAN: RPFReq
State Saved	Saved in instrument state.
Range	Abs Pwr & Freq Rel Pwr & Freq Integrated Power Carrier Info
Initial S/W Revision	Prior to A.02.00
Modified at S/W Revision	A.02.00, A.03.00, A.10.00

Views Selection by Number (Remote Command only)

The following numerical selections determine how the results are displayed:

1. displays the absolute power levels in dBm and the corresponding frequencies in the text window.
2. displays the relative power levels in dBc and the corresponding frequencies in the text window.
3. displays the absolute and relative power levels integrated throughout the bandwidths between the start and stop frequencies in the text window.
4. displays the carrier info table. (Only available in MSR and LTE-Advanced FDD/TDD)

Mode	SA, WCDMA, C2K, WIMAX OFDMA, TD-SCDMA, 1xEVDO, DTMB (CTTB), DVB-T/H, ISDB-T, CMMB, LTE, LTE-TDD, Digital Cable TV, WLAN, MSR, LTEAFDD, LTEATDD
Remote Command	:DISPlay:SEMask:VIEW:NSElect <integer> :DISPlay:SEMask:VIEW:NSElect?
Example	DISP:SEM:VIEW:NSEL 2 DISP:SEM:VIEW:NSEL?
Notes	In the SA mode, when "Radio Standard" is set to WLAN, Option 3 is not available. Option 4 is available only in MSR and LTE-Advanced FDD/TDD mode. You must be in the mode that includes SEM measurement to use this command. Use :INSTrument:SElect to set the mode.
Preset	SA, , WCDMA, , C2K, , TD-SCDMA, , 1xEVDO, , DTMB (CTTB), , DVB-T/H, , ISDB-T, , CMMB, , LTE, , LTE-TDD, , Digital Cable TV, , MSR, , LTEAFDD, , LTEATDD: 1 WIMAX OFDMA, WLAN: 2
State Saved	Saved in instrument state.
Min	1
Max	MSR, LTEAFDD, LTEATDD: 4 Other modes: 3
Initial S/W Revision	Prior to A.02.00
Modified at S/W Revision	A.02.00, A.03.00, A.10.00

Key Path	Front-panel key
Initial S/W Revision	Prior to A.02.00

Display

The Display menu is common to most measurements, and is used for configuring items on the display. Some Display menu settings apply to all the measurements in a mode, and some only to the current measurement. Those under the System Display Settings key apply to all measurements in all modes.

Key Path	Display
-----------------	---------

Key Path	View/Display
Initial S/W Revision	Prior to A.02.00

Annotation

Turns on and off various parts of the display annotation. The annotation is divided up into four categories:

1. Meas Bar: This is the measurement bar at the top of the screen. It does not include the settings panel or the Active Function. Turning off the Meas Bar turns off the settings panel and the Active Function. When the Meas Bar is off, the graticule area expands to fill the area formerly occupied by the Meas Bar.
2. Screen Annotation: this is the annotation and annunciation around the graticule, including any annotation on lines (such as the display line, the threshold line, etc.) This does NOT include the marker number or the N dB result. When off, the graticule expands to fill the entire graticule area.
3. Trace annotation: these are the labels on the traces, showing their detector (or their math mode).
4. Active Function annotation: this is the active function display in the meas bar, and all of the active function values displayed on softkeys.

See the figure below. Each type of annotation can be turned on and off individually.

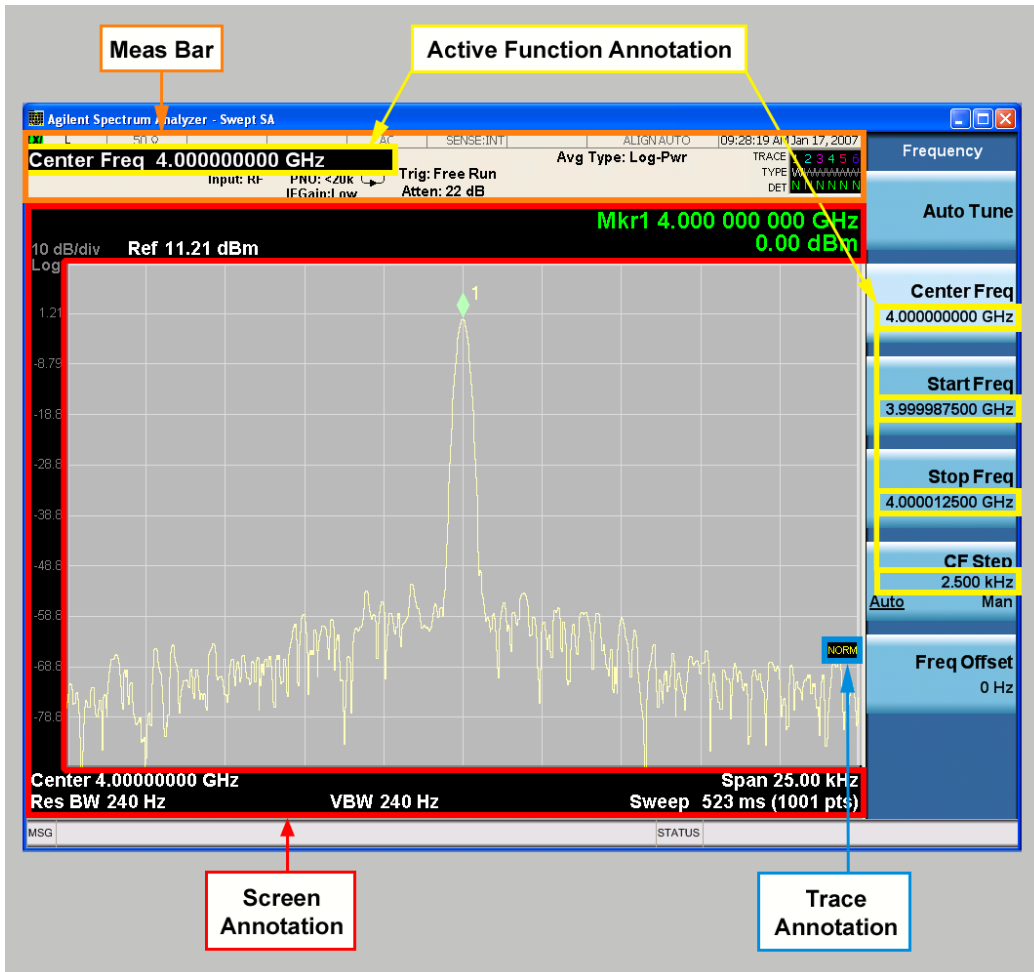

Key Path	View/Display, Display
Initial S/W Revision	Prior to A.02.00

Meas Bar On/Off

This function turns the Measurement Bar on and off, including the settings panel. When off, the graticule area expands to fill the area formerly occupied by the Measurement Bar.

Key Path	View/Display, Display, Annotation
Remote Command	:DISPlay:ANNotation:MBAR[:STATE] OFF ON 0 1 :DISPlay:ANNotation:MBAR[:STATE]?
Example	DISP:ANN:MBAR OFF
Dependencies	Grayed out and forced to OFF when System Display Settings, Annotation is set to Off.
Preset	On This should remain Off through a Preset when System DisplaySettings, Annotation is set to Off.

State Saved	Saved in instrument state.
Initial S/W Revision	Prior to A.02.00

Screen

This controls the display of the annunciation and annotation around the graticule, including any annotation on lines (such as the display line, the threshold line, etc.) and the y-axis annotation. This does NOT include marker annotation (or the N dB result). When off, the graticule expands to fill the entire graticule area, leaving only the 1.5% gap above the graticule as described in the Trace/Detector chapter.

Key Path	View/Display, Display, Annotation
Remote Command	:DISPlay:ANNotation:SCReen[:STATe] OFF ON 0 1 :DISPlay:ANNotation:SCReen[:STATe]?
Example	DISP:ANN:SCR OFF
Dependencies	Grayed-out and forced to OFF when System Display Settings, Annotation is set to Off.
Preset	On This should remain Off through a Preset when System DisplaySettings, Annotation is set to Off
State Saved	Saved in instrument state.
Initial S/W Revision	Prior to A.02.00

Active Function Values On/Off

Turns on and off the active function display in the Meas Bar, and all of the active function values displayed on the softkeys.

Note that all of the softkeys that have active functions have these numeric values blanked when this function is on. This is a security feature..

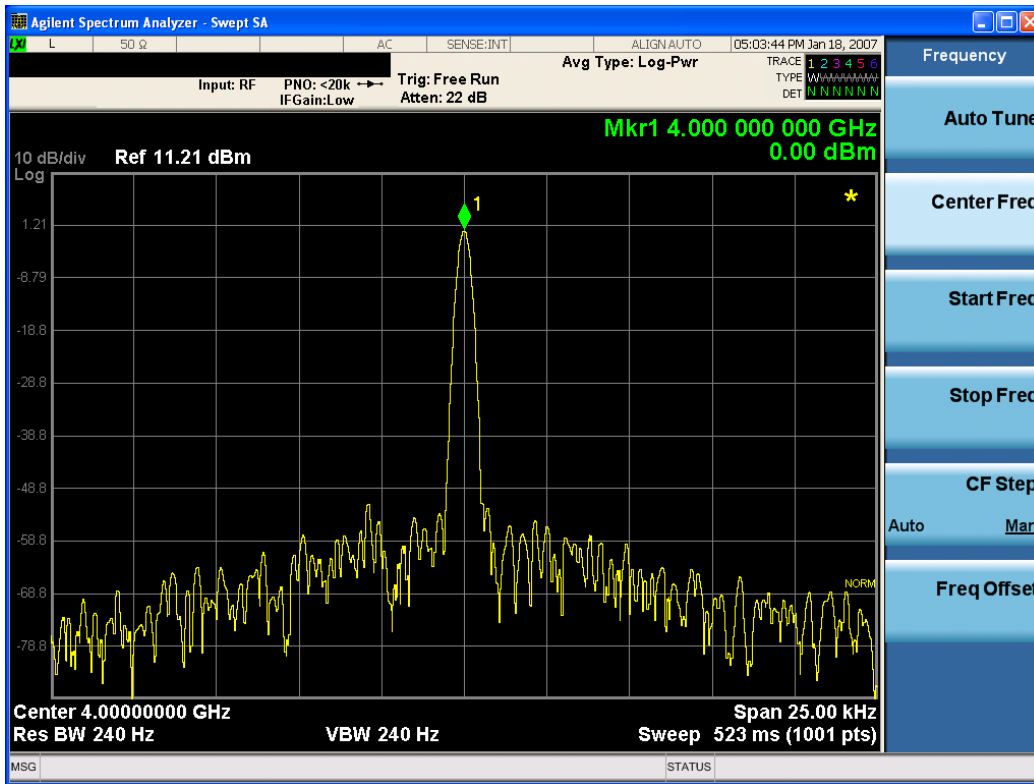

Key Path	View/Display, Display, Annotation
Remote Command	:DISPlay:ACTivefunc[:STATE] ON OFF 1 0 :DISPlay:ACTivefunc[:STATE]?
Example	DISP:ACT OFF
Dependencies	Grayed out and forced to OFF when System Display Settings, Annotation is set to Off.
Preset	On This should remain Off through a Preset when System DisplaySettings, Annotation is set to Off
State Saved	Saved in instrument state.
Initial S/W Revision	Prior to A.02.00

Title

Displays menu keys that enable you to change or clear a title on your display.

Key Path	View/Display, Display
Initial S/W Revision	Prior to A.02.00

Change Title

Writes a title into the "measurement name" field in the banner, for example, "Swept SA".

Press Change Title to enter a new title through the alpha editor. Press Enter or Return to complete the entry. Press ESC to cancel the entry and preserve your existing title.

The display title will replace the measurement name. It remains for this measurement until you press Change Title again, or you recall a state, or a Preset is performed. A title can also be cleared by pressing Title, Clear Title.

NOTE

Notice the inclusion of the <measurement> parameter in the command below. Because each measurement remembers the Display Title, the command must be qualified with the measurement name. For the Swept SA measurement this is not the case; no <measurement> parameter is used when changing the Display Title for the Swept SA measurement.

Key Path	View/Display, Display, Title
Mode	All
Remote Command	:DISPlay:<measurement>:ANNotation:TITLe:DATA <string> :DISPlay:<measurement>:ANNotation:TITLe:DATA?
Example	DISP:ANN:TITL:DATA "This Is My Title" This example is for the Swept SA measurement in the Spectrum Analyzer mode. The SANalyzer <measurement> name is not used. DISP:ACP:ANN:TITL:DATA "This Is My Title" This example is for Measurements other than Swept SA. Both set the title to: This Is My Title
Notes	Pressing this key cancels any active function. When a title is edited the previous title remains intact (it is not cleared) and the cursor goes at the end so that characters can be added or BKSP can be used to go back over previous characters.
Preset	No title (measurement name instead)
State Saved	Saved in instrument state.
Initial S/W Revision	Prior to A.02.00

Clear Title

Clears a title from the front-panel display. Once cleared, the title cannot be retrieved. After the title is cleared, the current Measurement Name replaces it in the title bar.

Key Path	View/Display, Display, Title
Example	The following commands clear the title and restore the measurement's original title: DISP:ANN:TITL:DATA "" This example is for the Swept SA measurement in the Spectrum Analyzer mode. The SANalyzer <measurement> name is not used. DISP:ACP:ANN:TITL:DATA "" This example is for ACP; in measurements other than Swept SA the measurement name is required.
Notes	Uses the :DISPlay:<measurement>:ANNotation:TITLe:DATA <string> command with an empty string (in the Swept SA, the <measurement> is omitted).

Preset	Performed on Preset.
Initial S/W Revision	Prior to A.02.00

Graticule

Pressing Graticule turns the display graticule On or Off. It also turns the graticule y-axis annotation on and off.

Key Path	View/Display, Display
Remote Command	:DISPlay:WINDow[1]:TRACe:GRATicule:GRID[:STATe] OFF ON 0 1 :DISPlay:WINDow[1]:TRACe:GRATicule:GRID[:STATe]?
Example	DISP:WIND:TRAC:GRAT:GRID OFF
Notes	The graticule is the set of horizontal and vertical lines that make up the grid/divisions for the x-axis and y-axis.
Preset	On
State Saved	Saved in instrument state
Initial S/W Revision	Prior to A.02.00

System Display Settings

These settings are "Mode Global" – they affect all modes and measurements and are reset only by Restore Misc Defaults or Restore System Defaults under System.

Key Path	View/Display, Display
Initial S/W Revision	Prior to A.02.00

Annotation Local Settings

This is a Mode Global override of the meas local annotation settings. When it is All Off, it forces ScreenAnnotation, Meas Bar, Trace, and Active Function Values settings to be OFF for all measurements in all modes. This provides the security based "annotation off" function of previous analyzers; hence it uses the legacy SCPI command.

When it is All Off, the Screen, Meas Bar, Trace, and Active Function Values keys under the Display, Annotation menu are grayed out and forced to Off. When Local Settings is selected, you are able to set the local annotation settings on a measurement by measurement basis.

Key Path	View/Display, Display, System Display Settings
Remote Command	:DISPlay:WINDow[1]:ANNOtation[:ALL] OFF ON 0 1 :DISPlay:WINDow[1]:ANNOtation[:ALL]?
Example	:DISP:WIND:ANN OFF

Preset	On (Set by Restore Misc Defaults)
State Saved	Not saved in instrument state.
Backwards Compatibility Notes	The WINDow parameter and optional subopcode is included for backwards compatibility but ignored – all windows are equally affected.
Initial S/W Revision	Prior to A.02.00

Themes

Accesses a menu of functions that enable you to choose the theme to be used when saving the screen image.

The **Themes** option is the same as the **Themes** option under the **Display** and **Page Setup** dialogs. It allows you to choose between themes to be used when saving the screen image.

Key Path	Save, Screen Image
Remote Command	:MMEMory:STORe:SCReen:THEMe TDColor TDMonochrome FCOLor FMONochrome :MMEMory:STORe:SCReen:THEMe?
Example	:MMEM:STOR:SCR:THEM TDM
Preset	3D Color; Is not part of Preset, but is reset by Restore Misc Defaults or Restore System Defaults All and survives subsequent running of the modes.
Readback	3D Color 3D Mono Flat Color Flat Mono
Backwards Compatibility Notes	In ESA and PSA we offer the choice of "Reverse Bitmap" or "Reverse Metafile" when saving screen images. This is much like the "Flat Color" theme available in X-Series. Also, if you selected Reverse Bitmap AND a black & white screen image, that would be much like "Flat Monochrome". In other words, each of the X-Series themes has a similar screen image type in ESA/PSA. But they are not identical.
Initial S/W Revision	Prior to A.02.00

3D Color

Selects a standard color theme with each object filled, shaded and colored as designed.

Key Path	Save, Screen Image, Themes
Example	MMEM:STOR:SCR:THEM TDC
Readback	3D Color
Initial S/W Revision	Prior to A.02.00

3D Monochrome

Selects a format that is like 3D color but shades of gray are used instead of colors.

Key Path	Save, Screen Image, Themes
Example	MMEM:STOR:SCR:THEM TDM
Readback	3D Mono
Initial S/W Revision	Prior to A.02.00

Flat Color

Selects a format that is best when the screen is to be printed on an ink printer.

Key Path	Save, Screen Image, Themes
Example	MMEM:STOR:SCR:THEM FCOL
Readback	Flat Color
Initial S/W Revision	Prior to A.02.00

Flat Monochrome

Selects a format that is like Flat Color. But only black is used (no colors, not even gray), and no fill.

Key Path	Save, Screen Image, Themes
Example	MMEM:STOR:SCR:THEM FMON
Readback	Flat Mono
Initial S/W Revision	Prior to A.02.00

Abs Pwr Freq

Sets the display to the Absolute Peak Power and Frequency view. The views differ depending on the setting of the measurement type (Meas Type) under the Measurement Setup menu.

"Abs Peak Pwr & Freq (Total Pwr Ref)" on page 1189

"Abs Peak Pwr & Freq (PSD Ref)" on page 1191

"Abs Peak Pwr & Freq (Spectrum Pk Ref)" on page 1193

Abs Peak Pwr & Freq (Total Pwr Ref)

This view consists of the following two windows:

"Trace Window" on page 1191

"Results Window " on page 1191

10 Spectrum Emission Mask Measurement
View/Display

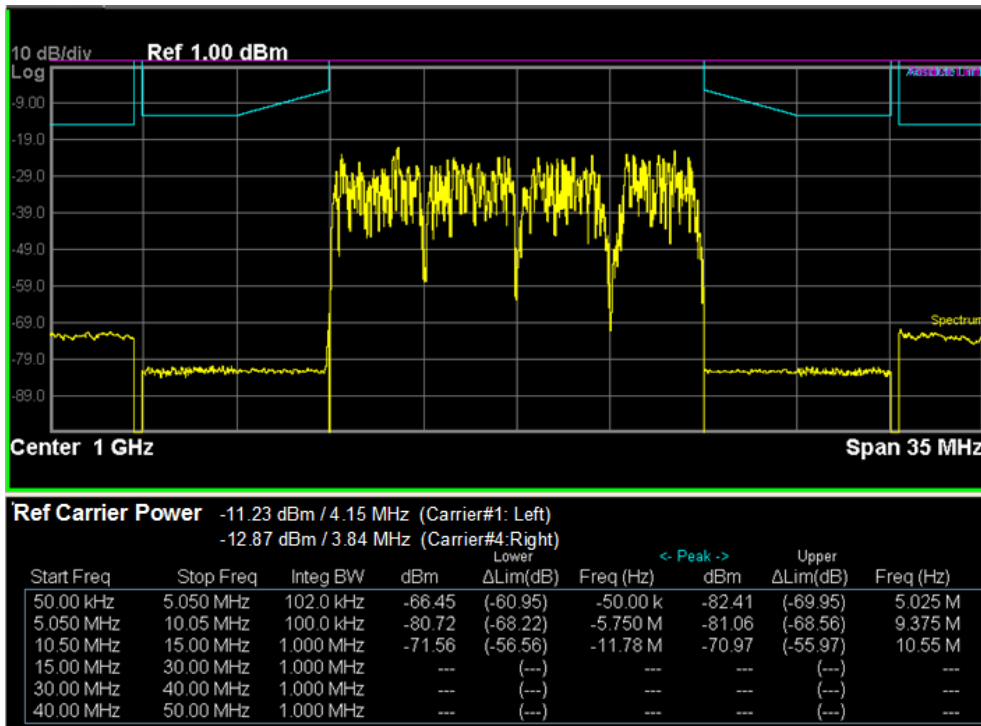
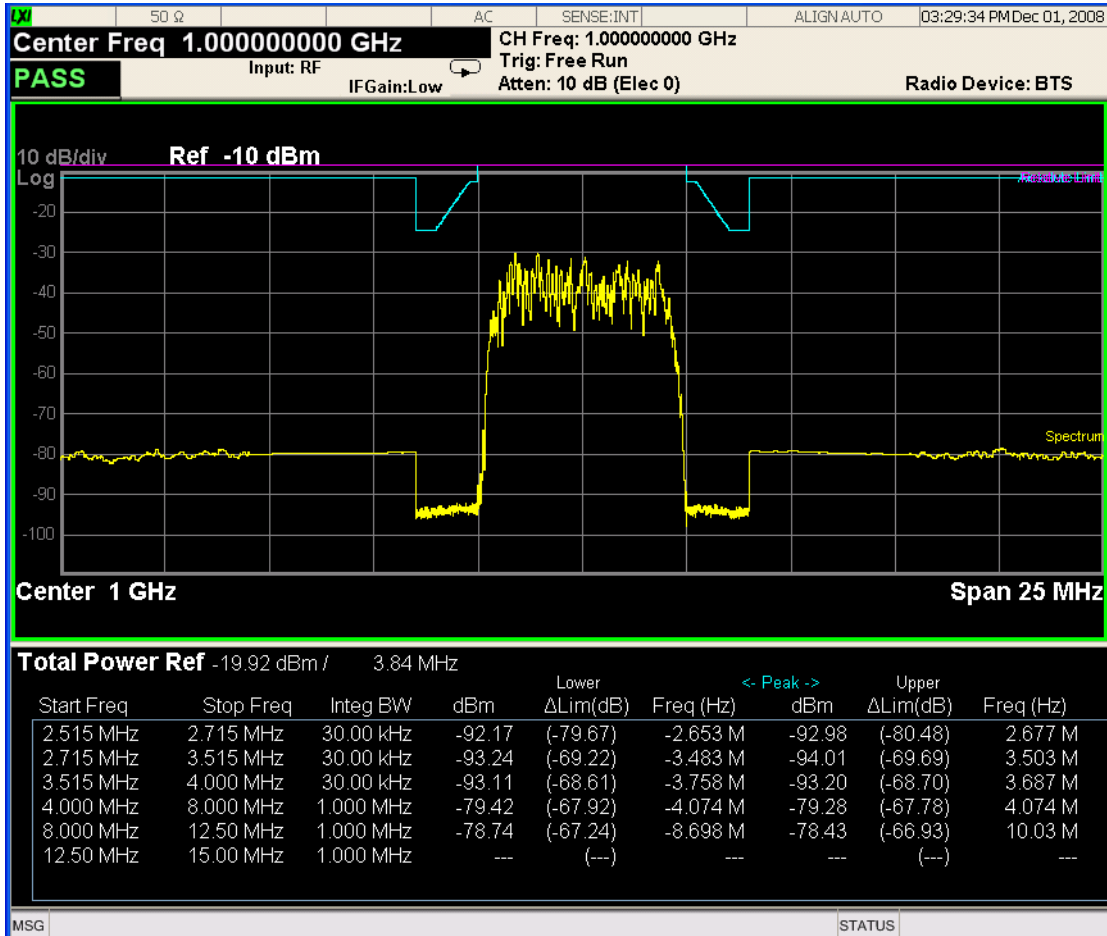

Trace Window

Corresponding Trace	yellow - Combined trace from carrier and each offset
---------------------	--

Results Window

Name	Corresponding Results
Total Pwr Ref	n=1 2nd element Absolute power at the reference area. Channel Integration Bandwidth
Start (Hz)	Start frequency for offset
Stop (Hz)	Stop frequency for offset
Meas BW (Hz)	Measurement bandwidth for offset
Lower Peak (dBm)	Absolute peak power on minimum margin point of the negative offset
Lower Δ lim (dB)	Minimum margin from limit line which is decided by Fail Mask setting on the negative offset
Lower Freq (Hz)	Frequency on minimum margin point of the negative offset
Upper Peak (dBm)	Absolute peak power on minimum margin point of the positive offset
Upper Δ lim (dB)	Minimum margin from limit line which is decided by Fail Mask setting on the positive offset
Upper Freq (Hz)	Frequency on minimum margin point of the positive offset

Abs Peak Pwr & Freq (PSD Ref)

This view consists of the following two windows:

"Trace Window" on page 1193

"Results Window " on page 1193

10 Spectrum Emission Mask Measurement
View/Display

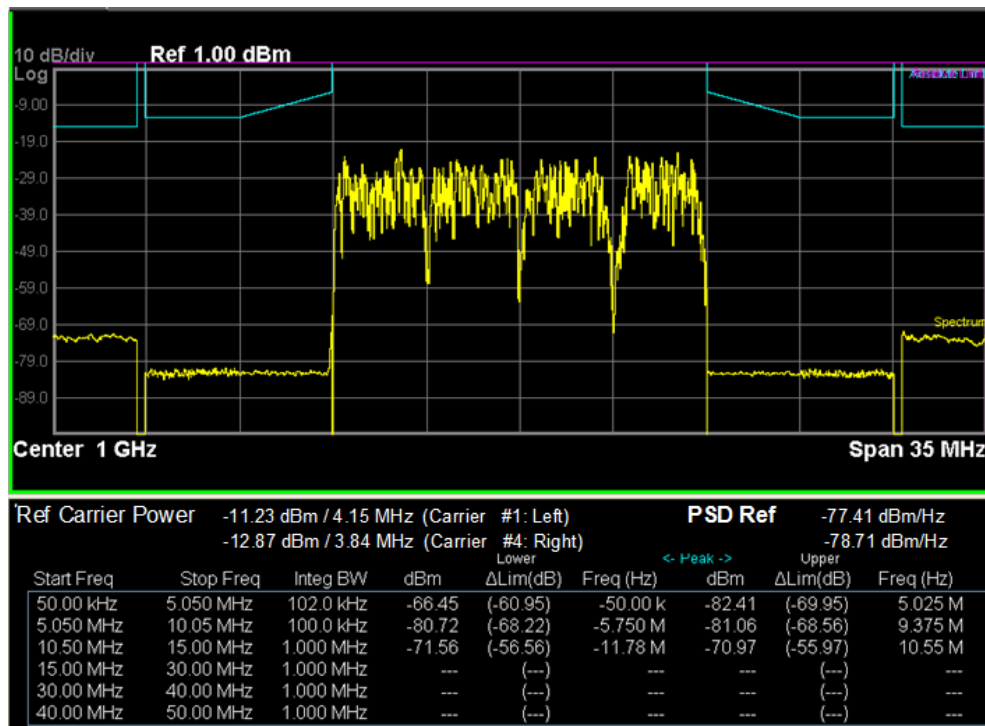
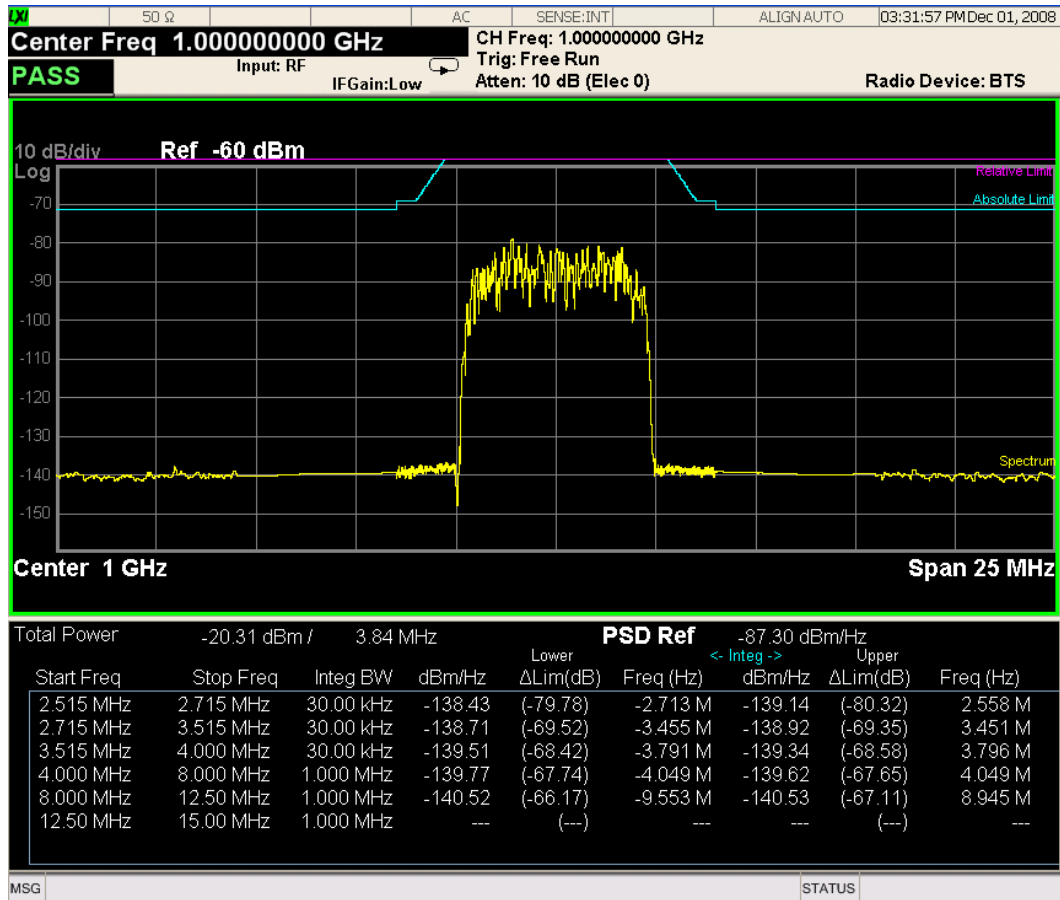

Trace Window

Corresponding Trace	yellow - Combined trace from carrier and each offset
---------------------	--

Results Window

Name	Corresponding Results
Total Pwr	n=1 2nd element Absolute power at the reference area.
	Channel Integration Bandwidth
PSD Ref	n=5 1st element Power spectral density reference at the reference area
Start (Hz)	Start frequency for offset
Stop (Hz)	Stop frequency for offset
Meas BW (Hz)	Measurement bandwidth for offset
Lower (dBm/Hz)	Absolute power spectrum density of the negative offset
Lower Δ lim (dB)	Minimum margin from limit line which is decided by Fail Mask setting on the negative offset
Lower Freq (Hz)	Frequency on minimum margin point of the negative offset
Upper (dBm/Hz)	Absolute power spectrum density of the positive offset
Upper Δ lim (dB)	Minimum margin from limit line which is decided by Fail Mask setting on the positive offset
Upper Freq (Hz)	Frequency on minimum margin point of the positive offset

Abs Peak Pwr & Freq (Spectrum Pk Ref)

This view consists of the following two windows:

"Trace Window" on page 1193

"Results Window " on page 1193

10 Spectrum Emission Mask Measurement
View/Display

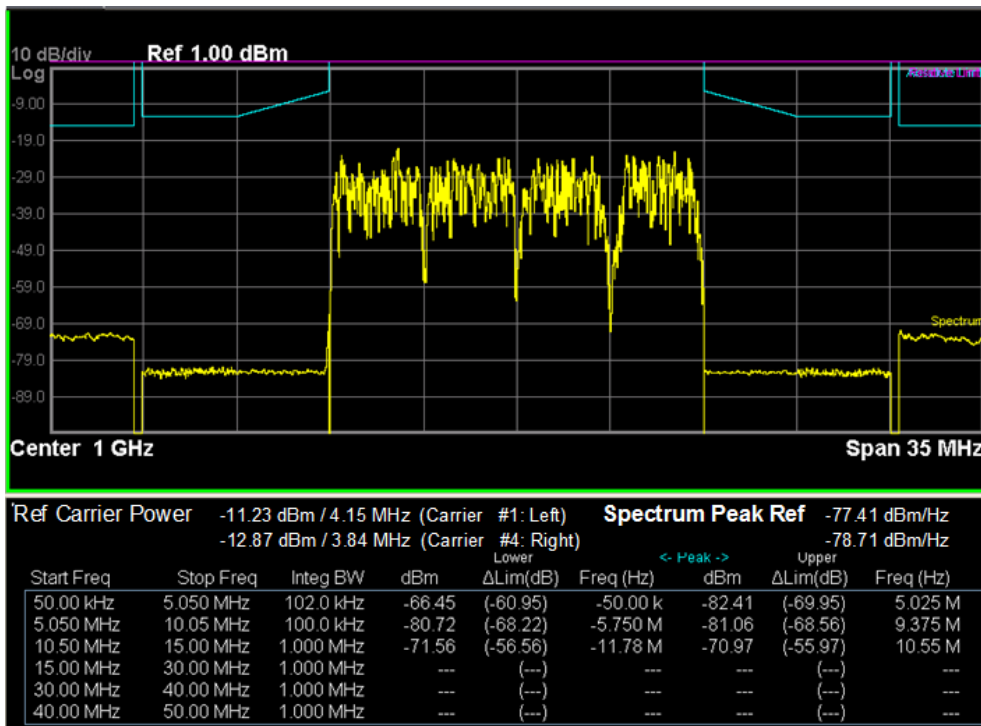
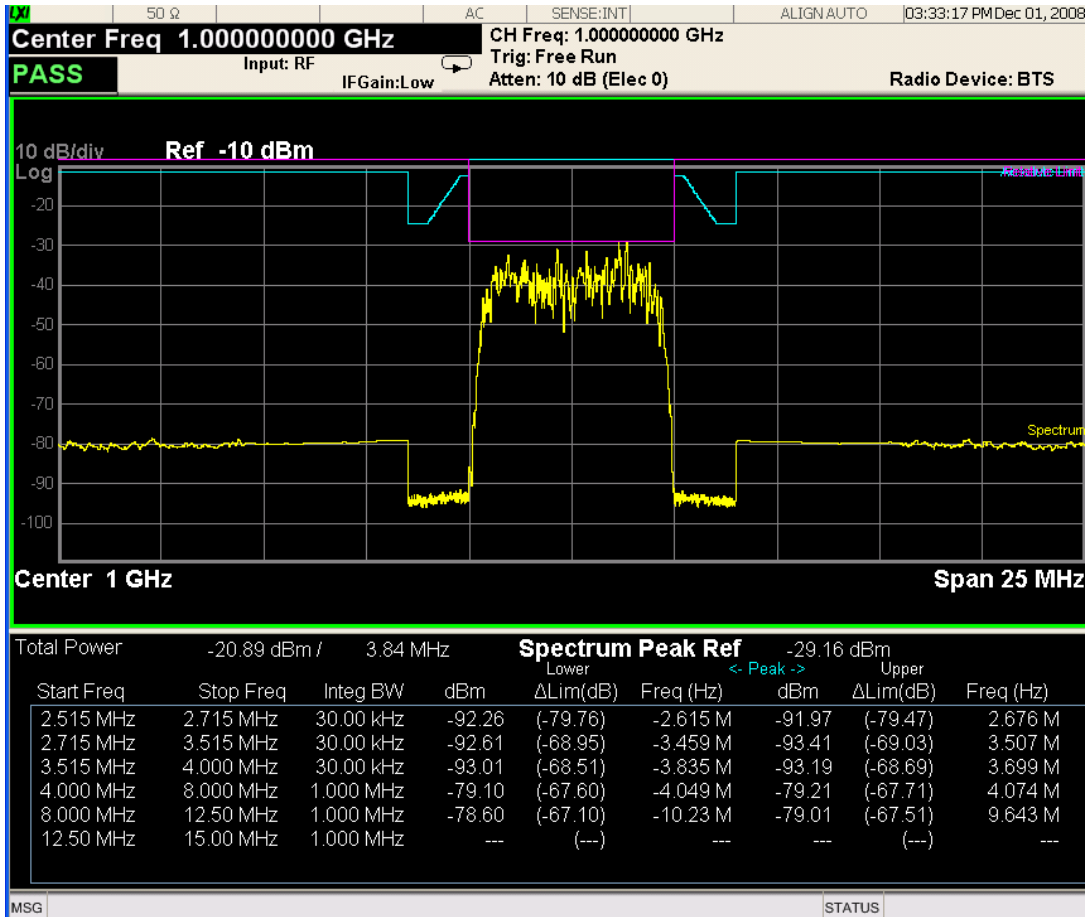

Trace Window

Corresponding Trace	yellow - Combined trace from carrier and each offset
---------------------	--

Results Window

Name	Corresponding Results
Total Pwr	Absolute power at the reference area. Channel Integration Bandwidth
Spectrum Peak Ref	n=5 1st element Spectrum peak power reference at the reference area
Start (Hz)	Start frequency for offset
Stop (Hz)	Stop frequency for offset
Meas BW (Hz)	Measurement bandwidth for offset
Lower(dBm)	Absolute peak power on minimum margin point of the negative offset
Lower Δ lim (dB)	Minimum margin from limit line which is decided by Fail Mask setting on the negative offset
Lower Freq (Hz)	Frequency on minimum margin point of the negative offset
Upper (dBm)	Absolute peak power on minimum margin point of the positive offset
Upper Δ lim (dB)	Minimum margin from limit line which is decided by Fail Mask setting on the positive offset
Upper Freq (Hz)	Frequency on minimum margin point of the positive offset

Key Path	View/Display
Initial S/W Revision	Prior to A.02.00

Rel Pwr Freq

Sets the display to the Relative Peak Power and Frequency view. The views differ depending on the setting of the measurement type (Meas Type) under the Measurement Setup menu.

"Rel Peak Pwr & Freq (Total Pwr Ref)" on page 1195

"Rel Peak Pwr & Freq (PSD Ref)" on page 1197

"Rel Peak Pwr & Freq (Spectrum Pk Ref)" on page 1198

Rel Peak Pwr & Freq (Total Pwr Ref)

This view consists of the following two windows:

"Trace Window" on page 1196

"Results Window" on page 1196

10 Spectrum Emission Mask Measurement
View/Display

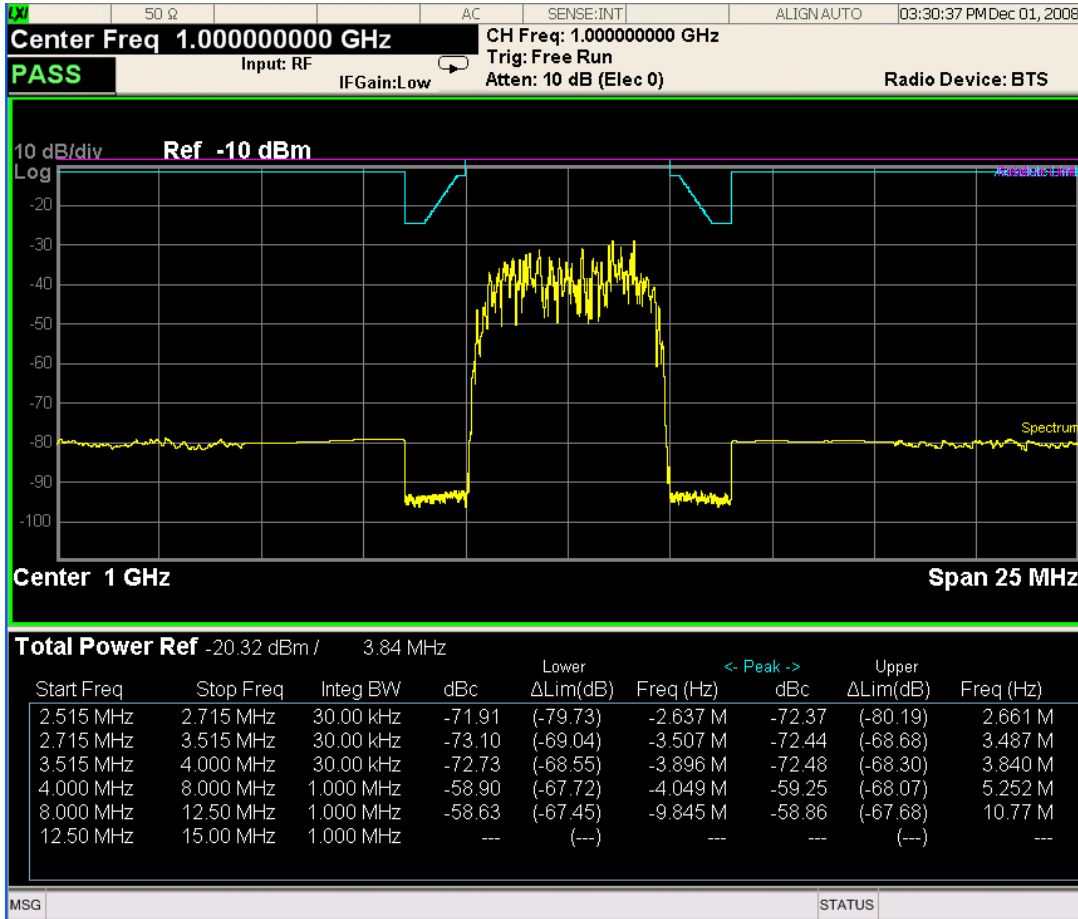

Trace Window

Corresponding Trace	yellow - Combined trace from carrier and each offset
---------------------	--

Results Window

Name	Corresponding Results
Total Pwr Ref	n=1 2nd element Absolute power at the reference area.
	Channel Integration Bandwidth
Start (Hz)	Start frequency for offset
Stop (Hz)	Stop frequency for offset
Meas BW (Hz)	Measurement bandwidth for offset
Lower Peak (dBc)	Relative peak power on minimum margin point of the negative offset
Lower ΔLim (dB)	Minimum margin from limit line which is decided by Fail Mask setting on the negative offset

Name	Corresponding Results
Lower Freq (Hz)	Frequency on minimum margin point of the negative offset
Upper Peak (dBc)	Relative peak power on minimum margin point of the positive offset
Upper ΔLim (dB)	Minimum margin from limit line which is decided by Fail Mask setting on the positive offset
Upper Freq (Hz)	Frequency on minimum margin point of the positive offset

Rel Peak Pwr & Freq (PSD Ref)

This view consists of the following two windows:

"Trace Window" on page 1197

"Results Window" on page 1198

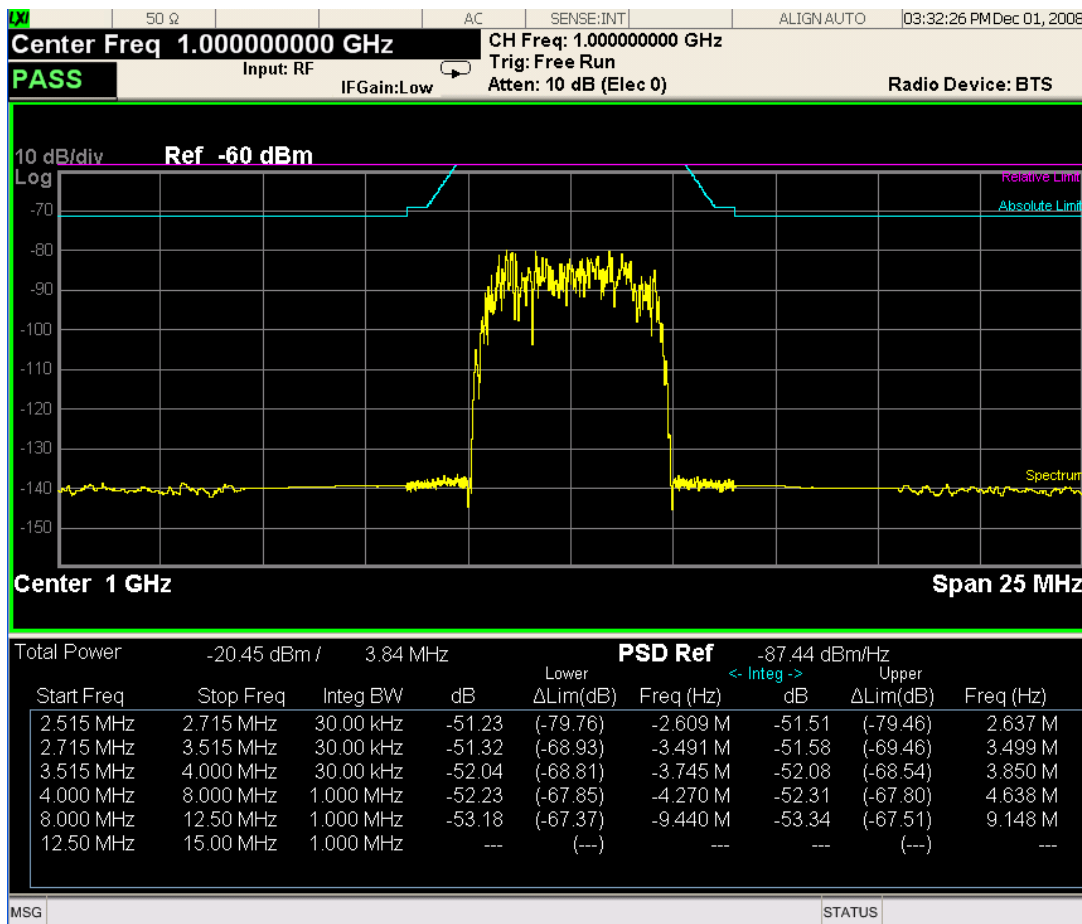

Trace Window

Corresponding Trace	yellow - Combined trace from carrier and each offset
---------------------	--

Results Window

Name	Corresponding Results
Total Pwr	n=1 2nd element Absolute power at the reference area.
	Channel Integration Bandwidth
PSD Ref	n=5 1st element Power spectral density reference at the reference area
Start (Hz)	Start frequency for offset
Stop (Hz)	Stop frequency for offset
Meas BW (Hz)	Measurement bandwidth for offset
Lower (dB)	Relative power spectrum density of the negative offset
Lower Δ Lim (dB)	Minimum margin from limit line which is decided by Fail Mask setting on the negative offset
Lower Freq (Hz)	Frequency on minimum margin point of the negative offset
Upper (dB)	Relative power spectrum density of the positive offset
Upper Δ Lim (dB)	Minimum margin from limit line which is decided by Fail Mask setting on the positive offset
Upper Freq (Hz)	Frequency on minimum margin point of the positive offset

Rel Peak Pwr & Freq (Spectrum Pk Ref)

This view consists of the following two windows:

"Trace Window" on page 1196

"Results Window" on page 1196

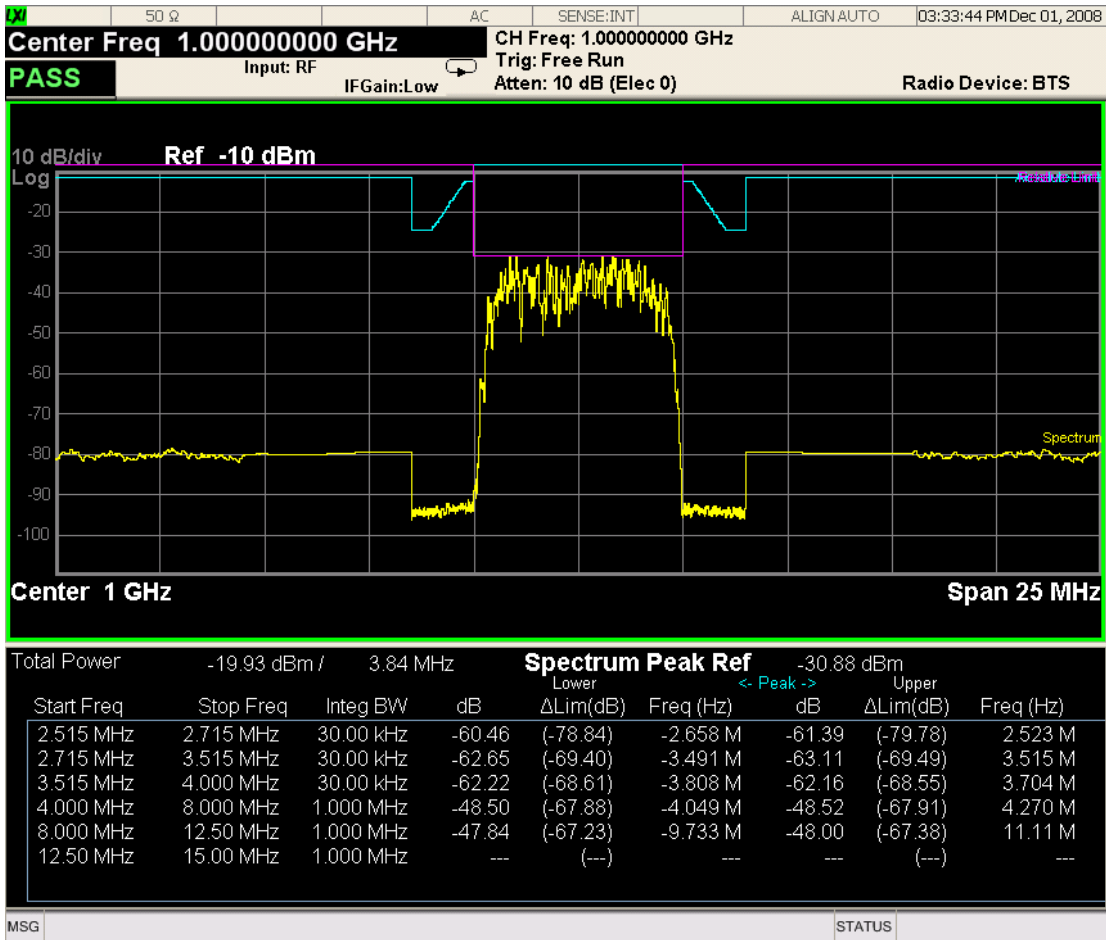

Trace Window

Corresponding Trace yellow - Combined trace from carrier and each offset

Results Window

Name	Corresponding Results
Total Pwr	Absolute power at the reference area.
	Channel Integration Bandwidth
Spectrum Peak Ref	n=5 1st element Spectrum peak power reference at the reference area
Start (Hz)	Start frequency for offset
Stop (Hz)	Stop frequency for offset
Meas BW (Hz)	Measurement bandwidth for offset
Lower Peak (dB)	Relative peak power on minimum margin point of the negative offset
Lower ΔLim (dB)	Minimum margin from limit line which is decided by Fail Mask setting

Name	Corresponding Results
	on the negative offset
Lower Freq (Hz)	Frequency on minimum margin point of the negative offset
Upper Peak (dB)	Relative peak power on minimum margin point of the positive offset
Upper Δ Lim (dB)	Minimum margin from limit line which is decided by Fail Mask setting on the positive offset
Upper Freq (Hz)	Frequency on minimum margin point of the positive offset

Key Path	View/Display
Initial S/W Revision	Prior to A.02.00

Integrated Power

Sets the display to the Integrated Power view. The views differ depending on the setting of the measurement type (Meas Type) under the Measurement Setup menu.

"Integrated Power (Total Pwr Ref)" on page 1200

"Integrated Power (PSD Ref)" on page 1203

"Integrated Power (Spectrum Pk Ref)" on page 1206

Integrated Power (Total Pwr Ref)

"Trace Window" on page 1202

"Results Window" on page 1202

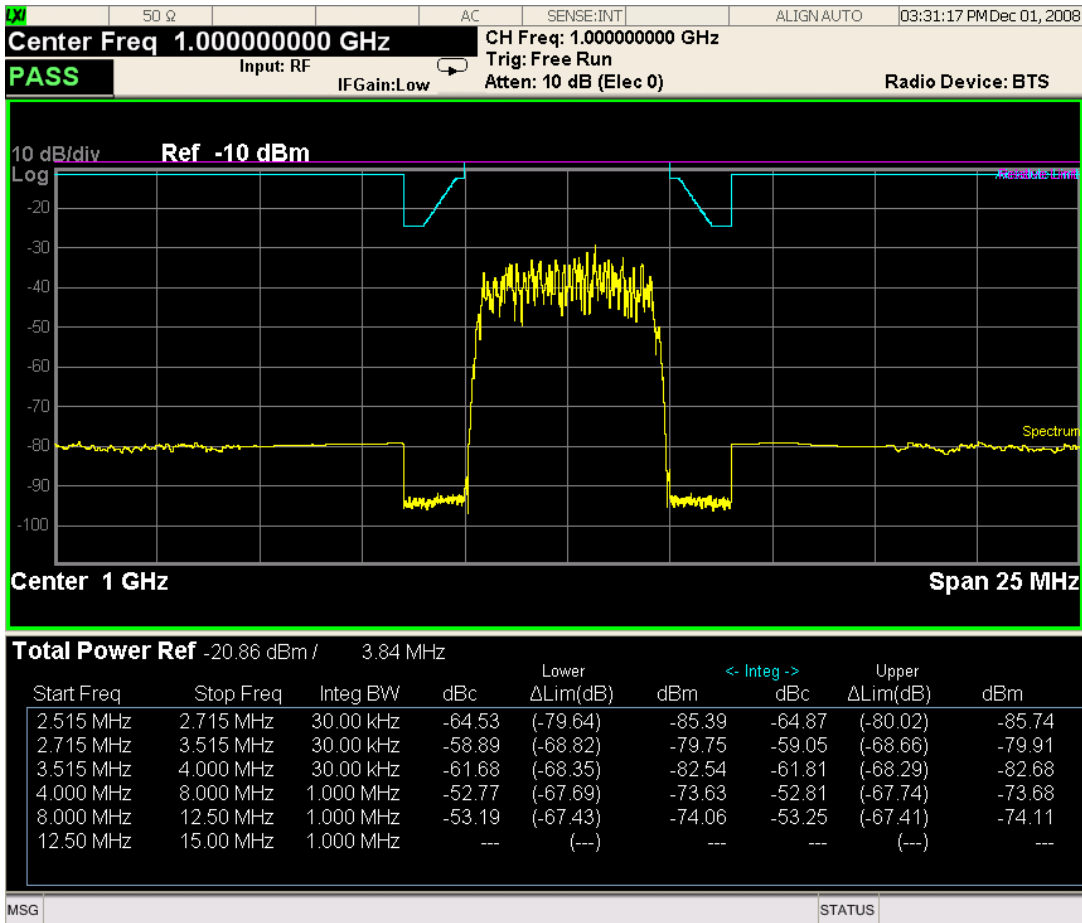

For WLAN 802.11 ac (80 + 80 MHz), power readouts of both of the carriers are displayed in the lower result window.

10 Spectrum Emission Mask Measurement
View/Display

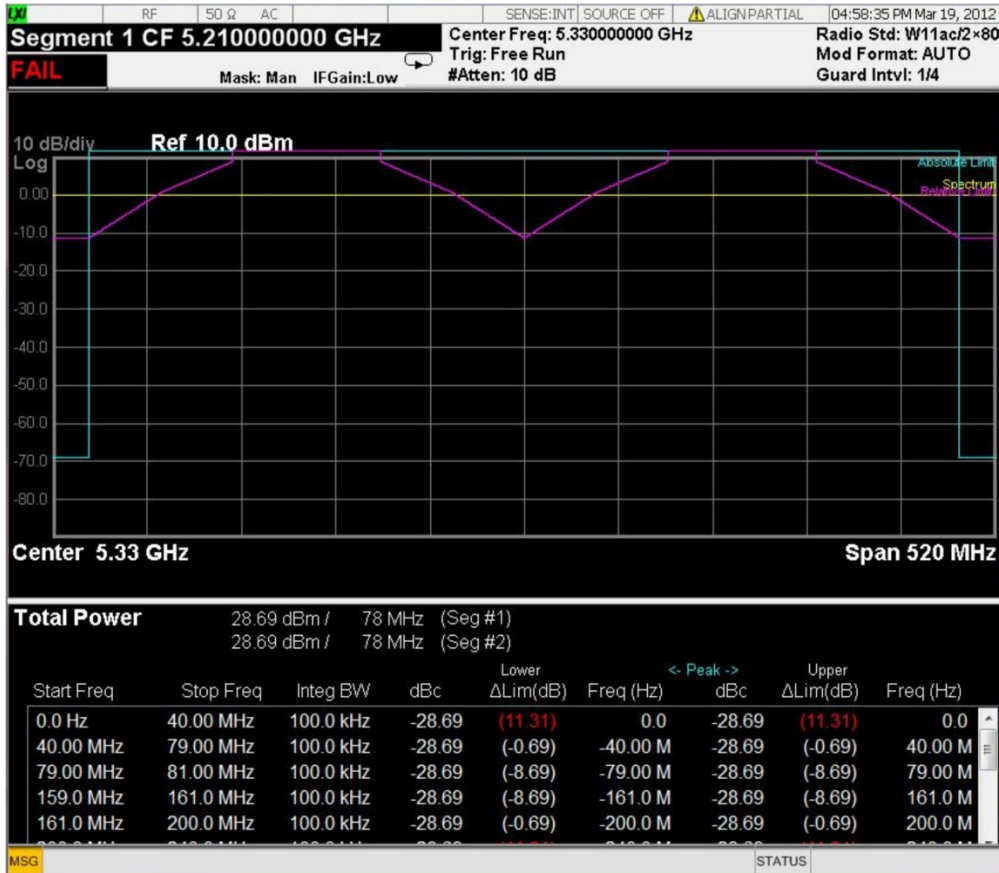

Trace Window

Corresponding Trace yellow - Combined trace from carrier and each offset

Results Window

Name	Corresponding Results
Total Pwr Ref	n=1 2nd element Absolute power at the reference area.
	Channel Integration Bandwidth
Start (Hz)	Start frequency for offset
Stop (Hz)	Stop frequency for offset
Meas BW (Hz)	Measurement bandwidth for offset
Lower Integ (dBc)	Relative integrated power on the negative offset
Lower ΔLim (dB)	Minimum margin from limit line which is decided by Fail Mask setting on the negative offset
Lower Integ (dBm)	Absolute integrated power on the negative offset

Name	Corresponding Results
Upper Integ (dBc)	Relative integrated power on the positive offset
Upper ΔLim (dB)	Minimum margin from limit line which is decided by Fail Mask setting on the positive offset
Upper Integ (dBm)	Absolute integrated power on the positive offset

Integrated Power (PSD Ref)

"Trace Window" on page 1205

"Results Window" on page 1205

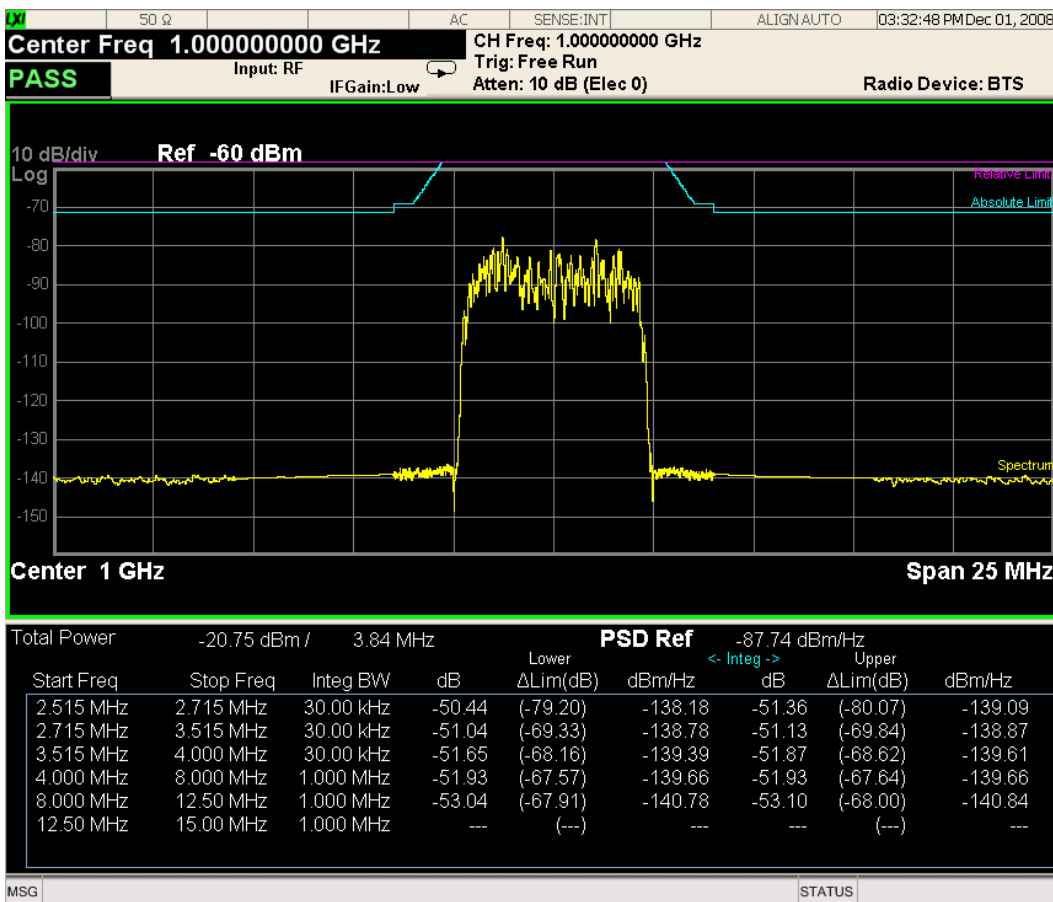

10 Spectrum Emission Mask Measurement View/Display

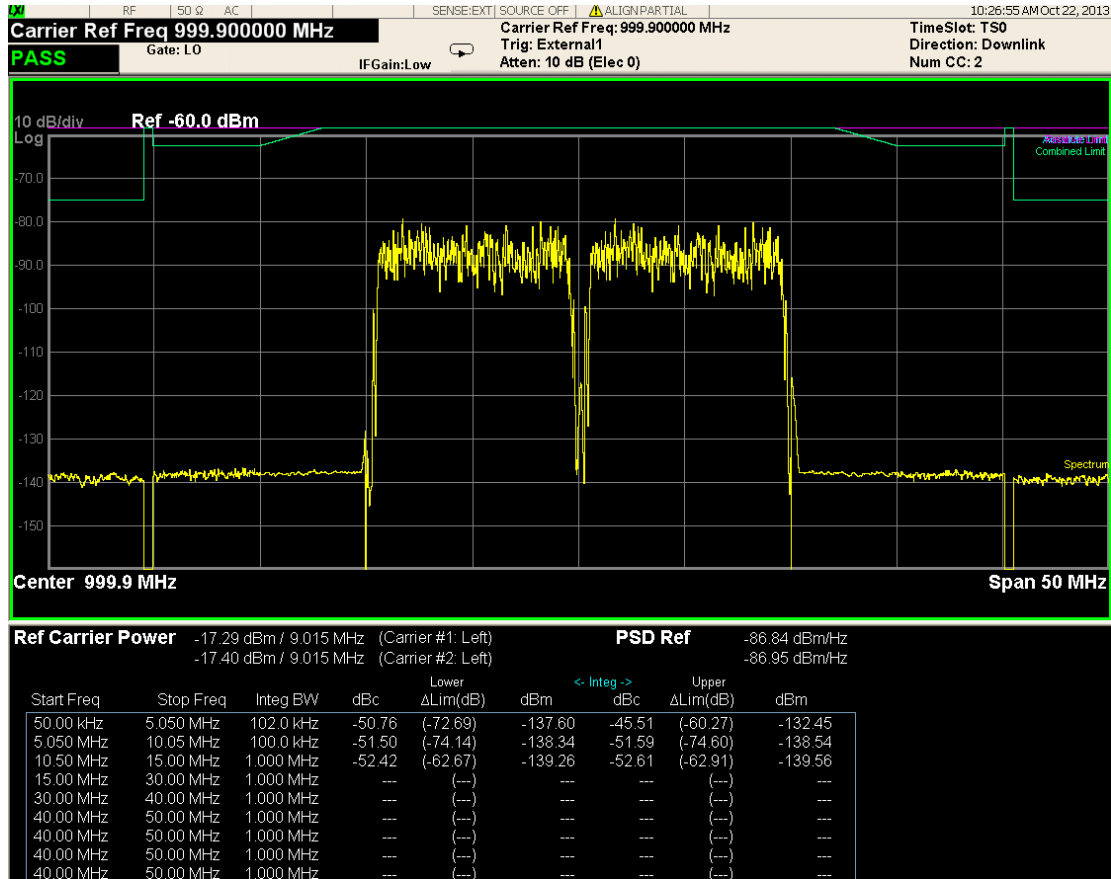

For WLAN 802.11ac (80 + 80 MHz), power readouts of both of the carriers are displayed in the lower result window.

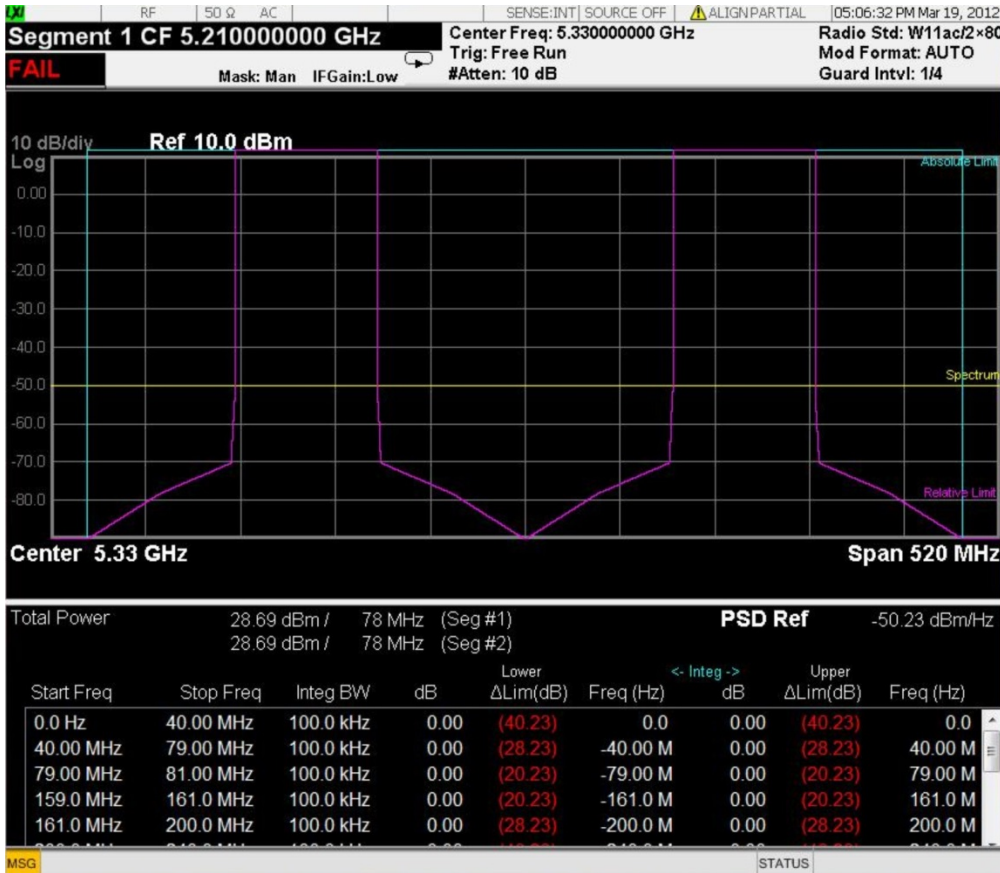

Trace Window

Corresponding Trace	yellow - Combined trace from carrier and each offset
---------------------	--

Results Window

Name	Corresponding Results
Total Pwr	n=1 2nd element Absolute power at the reference area. Channel Integration Bandwidth
PSD Ref	n=5 1st element Power spectral density reference at the reference area
Start (Hz)	Start frequency for offset
Stop (Hz)	Stop frequency for offset
Meas BW (Hz)	Measurement bandwidth for offset
Lower (dB)	Relative power spectrum density of the negative offset
Lower ΔLim (dB)	Minimum margin from limit line which is decided by Fail Mask setting on the negative offset

Name	Corresponding Results
Lower (dBm/Hz)	Absolute power spectrum density of the negative offset
Upper (dB)	Relative power spectrum density of the positive offset
Upper ΔLim (dB)	Minimum margin from limit line which is decided by Fail Mask setting on the positive offset
Upper (dBm/Hz)	Absolute power spectrum density of the negative offset

Integrated Power (Spectrum Pk Ref)

"Trace Window" on page 1202

"Results Window" on page 1202

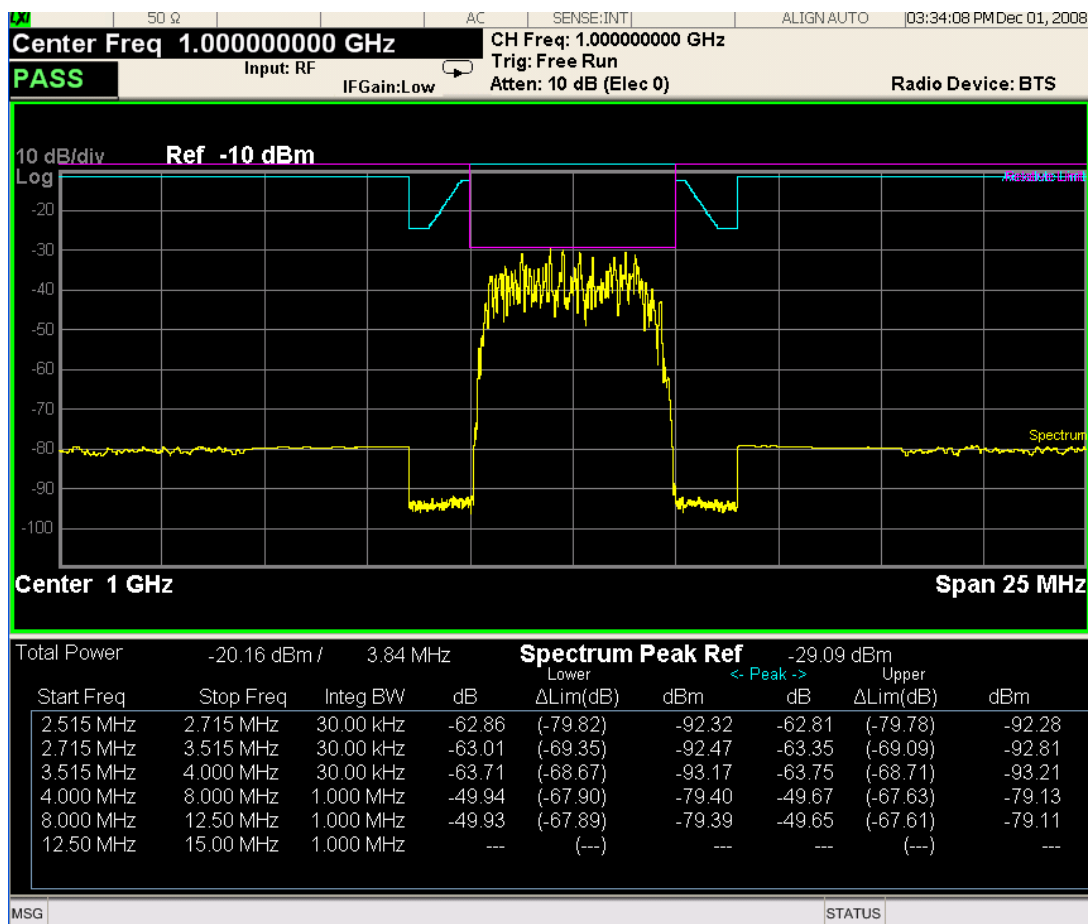

For WLAN 802.11ac (80 + 80 MHz), power readouts of both of the carriers are displayed in the lower result window.

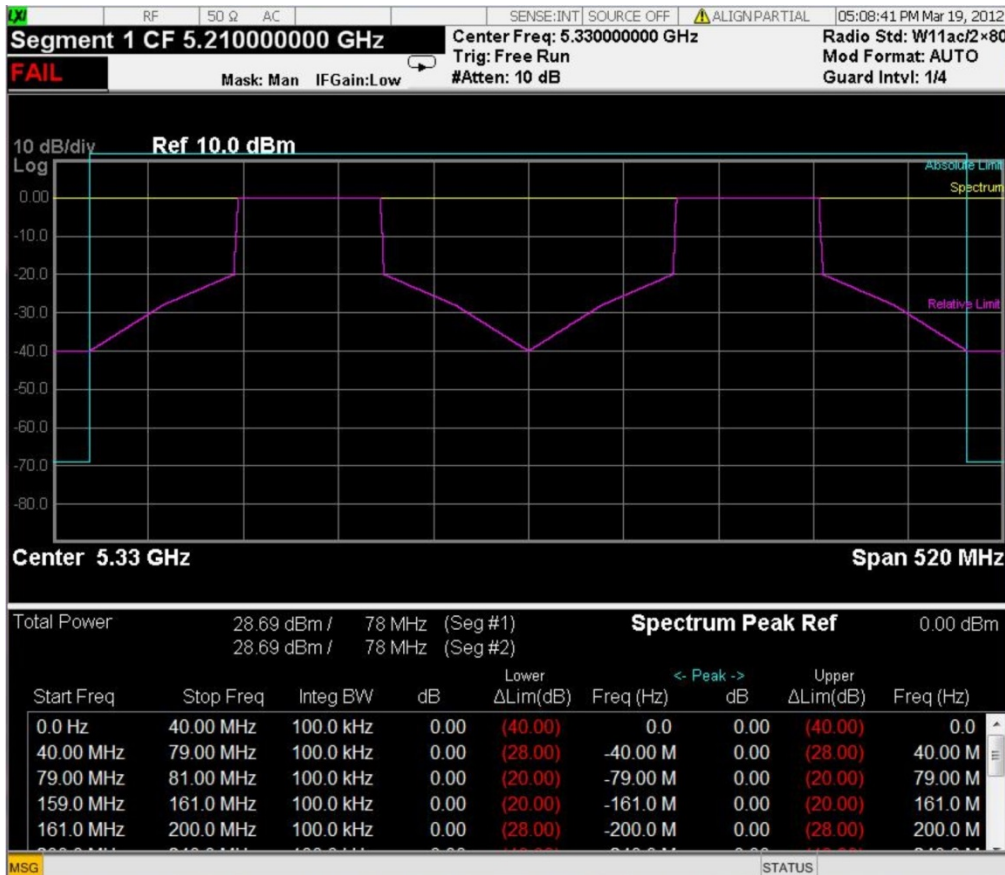

Trace Window

Corresponding Trace yellow - Combined trace from carrier and each offset

Results Window

Name	Corresponding Results
Total Pwr	Absolute power at the reference area. Channel Integration Bandwidth
Spectrum Peak Ref	n=5 1st element Peak power at the reference area
Start (Hz)	Start frequency for offset
Stop (Hz)	Stop frequency for offset
Meas BW (Hz)	Measurement bandwidth for offset
Lower Peak (dB)	Relative peak power on minimum margin point of the negative offset
Lower Δlim (dB)	Minimum margin from limit line which is decided by Fail Mask setting on the negative offset

Name	Corresponding Results
Lower Peak (dBm)	Absolute peak power on minimum margin point of the negative offset
Upper Peak (dB)	Relative peak power on minimum margin point of the positive offset
Upper Δ lim (dB)	Minimum margin from limit line which is decided by Fail Mask setting on the positive offset
Upper Peak (dBm)	Absolute peak power on minimum margin point of the positive offset

Key Path	View/Display
Initial S/W Revision	Prior to A.02.00

Limit Lines

Toggles the limit lines display function for the spectrum emission mask measurements On and Off.

Key Path	View/Display
Mode	SA, WCDMA, C2K, WIMAX OFDMA, TD-SCDMA, 1xEVDO, DTMB (CTTB), DVB-T/H, ISDB-T, CMMB, LTE, LTE-TDD, Digital Cable TV, WLAN, MSR, LTEAFDD, LTEATDD
Remote Command	:CALCulate:SEMask:LLINe:STATe ON OFF 1 0 :CALCulate:SEMask:LLINe:STATe?
Example	CALC:SEM:LLIN:STAT OFF CALC:SEM:LLIN:STAT?
Notes	You must be in the mode that includes SEM measurement to use this command. Use :INSTrument:SElect to set the mode.
Preset	ON
State Saved	Saved in instrument state.
Range	On Off
Initial S/W Revision	Prior to A.02.00
Modified at S/W Revision	A.02.00, A.03.00

11 Occupied Bandwidth Measurement

The Occupied Bandwidth measurement computes and displays the bandwidth occupied by a given percentage of the total mean power of a signal. For measurement results and views, see [View/Display](#).

This topic contains the following sections:

["Remote Commands for Occupied Bandwidth" on page 1210](#)

["Remote Command Results for Occupied Bandwidth Measurement" on page 1211](#)

Remote Commands for Occupied Bandwidth

The following commands and queries can be used to retrieve the measurement results:

```
:CONFigure:OBWidth  
:CONFigure:OBWidth:NDEFault  
:INITiate:OBWidth  
:FETCh:OBWidth[n]?  
:MEASure:OBWidth[n]?  
:READ:OBWidth[n]?  
:FETCh:OBWidth:OBWidth?  
:MEASure:OBWidth:OBWidth?  
:READ:OBWidth:OBWidth?  
:FETCh:OBWidth:FERRor?  
:MEASure:OBWidth:FERRor?  
:READ:OBWidth:FERRor?  
:FETCh:OBWidth:XDB?  
:MEASure:OBWidth:XDB?  
:READ:OBWidth:XDB?
```

See also the section, Remote Measurement Functions@29978.

Remote Command Results for Occupied Bandwidth Measurement

The following table describes the results returned by the FETCh:OBWidth[n]?, MEASure:OBWidth[n]?, and READ:OBWidth[n]? queries listed above, according to the index value n.

n	Results Returned
n=1 (or not specified)	Returns 7 scalar results, in the following order: 1. Occupied bandwidth - Hz 2. Total Power - dBm (Total Power will be obsolete in TD-SCDMA mode, this place will be replaced by NaN) 3. Span - Hz 4. Spectrum Trace Points - points 5. Res BW - Hz 6. Transmit Frequency Error Hz 7. x DB Bandwidth - Hz
2	Returns the frequency-domain spectrum trace (data array) for the entire frequency range being measured.
n = 3 (Mode = MSR, LTEAFDD, LTEATDD)	1. Number of active carriers Returns number of active carriers within Span in Auto detected mode, otherwise the command is out of scope

Key Path	Meas
Initial S/W Revision	Prior to A.02.00

AMPTD Y Scale (Amplitude/Y Scale)

Activates the Reference Value function and displays the Amplitude menu keys. These functions control how data on the vertical (Y) axis is displayed and control instrument settings that affect the vertical axis

See AMPTD Y Scale for more information.

Key Path	Front-panel key
Initial S/W Revision	Prior to A.02.00

Ref Value

Sets the absolute power reference value. However, since the Auto Scaling is defaulted to On, this value is automatically determined by the measurement result. When you set a value manually, Auto Scaling automatically changes to Off.

Key Path	AMPTD Y Scale
Mode	SA, WCDMA, C2K, WIMAX OFDMA, TD-SCDMA, 1xEVDO, ISDB-T, CMMB, LTE, LTETDD, BLUETOOTH, WLAN, MSR, LTEAFDD, LTEATDD
Remote Command	:DISPlay:OBWidth:VIEW[1]:WINDow[1]:TRACe:Y[:SCALe]:RLEVel <real> :DISPlay:OBWidth:VIEW[1]:WINDow[1]:TRACe:Y[:SCALe]:RLEVel?
Example	DISP:OBW:VIEW:WIND:TRAC:Y:RLEV 125 DISP:OBW:VIEW:WIND:TRAC:Y:RLEV?
Notes	You must be in the Spectrum Analysis mode, W-CDMA mode, cdma2000 mode, TD-SCDMA mode, ISDB-T mode, CMMB mode, BLUETOOTH mode, LTE mode, LTE TDD mode, WLAN mode, 1xEVDO mode, MSR, LTE-Advanced FDD/TDD or WIMAX OFDMA mode to use this command. Use:INSTrument:SElect to set the mode.
Couplings	When the Auto Scaling is On, this value is automatically determined by the measurement result. When you set a value manually, Auto Scaling automatically changes to Off.
Preset	10.00 dBm
State Saved	Saved in instrument state.
Min	-250.00 dBm
Max	250.00 dBm
Initial S/W Revision	Prior to A.02.00
Modified at S/W Revision	A.03.00

Range

The Range menu allows setting amplitude controls of the instrument.

Key Path	AMPTD Y Scale
----------	---------------

Scope	Meas Global
Initial S/W Revision	A.12.50

Range

Represents the amplitude of the largest sinusoidal signal that could be present within the IF without being clipped by the ADC. For signals with high peak-to-average ratios, the range may need to exceed the rms signal power by a fair amount to avoid clipping.

Key Path	Range
Mode	BASIC
Remote Command	<code>[:SENSe] :POWer [:RF] :RANGe <real></code> <code>[:SENSe] :POWer [:RF] :RANGe?</code>
Example	<code>:POW:RANG 10.0</code> <code>:POW:RANG?</code>
Notes	The MIN and MAX values are affected by the External Gain parameters, and by the Center Frequency. (The hardware compensates for frequency response and alters the Range setting.)
Preset	0
State Saved	Saved in instrument state.
Min	-100
Max	100
Initial S/W Revision	A.12.50

Adjust Range For Min Clip

Sets the combination of attenuation and gain based on the current measured signal level so that clipping will be at a minimum.

This is an "immediate action" function, that is, it executes once, when the key is pressed.

This key is grayed out in measurements that do not support this functionality.

Key Path	AMPTD Y Scale, Attenuation
Remote Command	<code>[:SENSe] :POWer [:RF] :RANGe:OPTimize IMMEDIATE</code>
Initial S/W Revision	Prior to A.02.00
Modified at S/W Revision	A.03.00

Pre-Adjust for Min Clip

If this function is on, it does the adjustment described under Adjust Range For Min Clip each time a measurement restarts. Therefore, in Continuous measurement mode, it only executes before the first

measurement.

Key Path	AMPTD Y Scale, Attenuation
Remote Command	<code>[:SENSE] :POWER [:RF] :RANGE:OPTimize:ATTenuation OFF ON ELECTRical COMBined</code> <code>[:SENSE] :POWER [:RF] :RANGE:OPTimize:ATTenuation?</code>
Notes	This parameter is shared with old XA platform which uses AutoAtten. To keep the backward compatibility, ELECTRical and COMBined still can be used. Then, upon receiving ELECTRical and COMBined, these enums will be interpreted as aliases of ON. Then, when queried, ON will be returned.
Preset	OFF for Swept SA measurement; ON for all other measurements that support Pre-Adjust for Min Clip
State Saved	Saved in instrument state
Initial S/W Revision	Prior to A.02.00
Modified at S/W Revision	A.03.00

Peak to Average

The Peak to Average Ratio is used with the Range setting to optimize the level control in the instrument. The value is the ratio, in dB, of the peak power to the average power of the signal to be measured. A ratio of 0 should be used for sinusoidal signals; for 802.11g OFDM signals use 9 dB.

All Applications (Modes) will show the current value of Peak to Average ratio on the softkey. However, some applications will not permit changing the value. In these situations the softkey will be grayed-out.

Key Path	AMPTD Y Scale, Range
Remote Command	<code>[:SENSE] :POWER [:RF] :RANGE:PARatio <real></code> <code>[:SENSE] :POWER [:RF] :RANGE:PARatio?</code>
Example	POW:RANG:PAR 12 dB
Notes	In some Applications (Modes) this parameter will be read-only; meaning the value will appear on the softkey and query via SCPI, but not changeable. In such applications the softkey will be grayed-out. Attempting to change the value via SCPI will be ignored and no error message will be generated.
Preset	10 dB
State Saved	Saved in instrument state
Min	0 dB
Max	20 dB
Initial S/W Revision	A.13.00

Mixer Level Offset

Mixer level offset is an advanced setting to adjust target Range at the input mixer which in turn affects the signal level in the instrument's IF. This setting can be used when additional optimization is needed after

setting Peak to Average ratio. Positive values of offset optimize noise performance over distortion, negative values optimize distortion performance over noise.

Key Path	AMPTD Y Scale, Range
Remote Command	[:SENSE] :POWER [:RF] :RANGE:MIXer:OFFSet <real> [:SENSE] :POWER [:RF] :RANGE:MIXer:OFFSet?
Example	POW:RANG:MIX:OFFS -5 dB
Preset	0 dB
State Saved	Saved in instrument state
Min	-35 dB
Max	30 dB
Initial S/W Revision	A.13.00

Scale/Div

Sets the logarithmic units per vertical graticule division on the display. When the Auto Scaling is On, the Scale/Div is automatically determined by the measurement result. When you set a value manually, Auto Scaling is automatically toggled to Off.

Key Path	AMPTD Y Scale
Mode	SA, WCDMA, C2K, WIMAX OFDMA, TD-SCDMA, 1xEVDO, ISDB-T, CMMB, LTE, LTETDD, BLUETOOTH, WLAN, MSR, LTEAFDD, LTEATDD
Remote Command	:DISPlay:OBWidth:VIEW[1]:WINDow[1]:TRACe:Y[:SCALE]:PDIVision <rel_ampl> :DISPlay:OBWidth:VIEW[1]:WINDow[1]:TRACe:Y[:SCALE]:PDIVision?
Example	DISP:OBW:VIEW:WIND:TRAC:Y:PDIV 5 DISP:OBW:VIEW:WIND:TRAC:Y:PDIV?
Notes	You must be in the Spectrum Analysis mode, W-CDMA mode, cdma2000 mode, TD-SCDMA mode, ISDB-T mode, CMMB mode, LTE mode, LTE TDD mode, BLUETOOTH mode, WLAN mode, 1xEVDO mode, MSR, LTE-Advanced FDD/TDD or WIMAX OFDMA mode to use this command. Use :INSTrument:SElect to set the mode.
Couplings	When the Auto Scaling is On, this value is automatically determined by the measurement result. When you set a value manually, Auto Scaling automatically changes to Off.
Preset	10.00 dB
State Saved	Saved in instrument state.
Min	0.10 dB
Max	20.00 dB
Initial S/W Revision	Prior to A.02.00
Modified at S/W Revision	A.03.00

Ref Position

Positions the reference level at the top, center or bottom of the Y Scale display. Changing the reference position does not change the reference level value.

Key Path	AMPTD Y Scale
Mode	SA, WCDMA, C2K, WIMAX OFDMA, TD-SCDMA, 1xEVDO, ISDB-T, CMMB, LTE, LTETDD, BLUETOOTH, WLAN, MSR, LTEAFDD, LTEATDD
Remote Command	:DISPlay:OBWidth:VIEW[1]:WINDow[1]:TRACe:Y[:SCALe]:RPOSition TOP CENTer BOTTom :DISPlay:OBWidth:VIEW[1]:WINDow[1]:TRACe:Y[:SCALe]:RPOSition?
Example	DISP:OBW:VIEW:WIND:TRAC:Y:RPOS BOTT DISP:OBW:VIEW:WIND:TRAC:Y:RPOS?
Notes	You must be in the Spectrum Analysis mode, W-CDMA mode, cdma2000 mode, TD-SCDMA mode, ISDB-T mode, CMMB mode, LTE mode, LTE TDD mode, BLUETOOTH mode, WLAN mode, 1xEVDO mode, MSR, LTE-Advanced FDD/TDD or WIMAX OFDMA mode to use this command. Use:INSTrument:SElect to set the mode.
Preset	TOP
State Saved	Saved in instrument state.
Range	Top Ctr Bot
Initial S/W Revision	Prior to A.02.00
Modified at S/W Revision	A.03.00

Auto Scaling

Allows you to toggle the Auto Scaling function between On and Off.

Key Path	AMPTD Y Scale
Mode	SA, WCDMA, C2K, WIMAX OFDMA, TD-SCDMA, 1xEVDO, ISDB-T, CMMB, LTE, LTETDD, BLUETOOTH, WLAN, MSR, LTEAFDD, LTEATDD
Remote Command	:DISPlay:OBWidth:VIEW[1]:WINDow[1]:TRACe:Y[:SCALe]:COUPle 0 1 OFF ON :DISPlay:OBWidth:VIEW[1]:WINDow[1]:TRACe:Y[:SCALe]:COUPle?
Example	DISP:OBW:VIEW:WIND:TRAC:Y:COUP ON DISP:OBW:VIEW:WIND:TRAC:Y:COUP?
Couplings	When Auto Scaling is On, upon pressing the Restart front-panel key, this function automatically sets the scale per division to 10 dB and determines reference values based on the measurement results. When you set a value to either Scale/Div or Ref Value manually, Auto Scaling automatically changes to Off.
Preset	1
State Saved	Saved in instrument state.
Range	On Off

Initial S/W Revision	Prior to A.02.00
Modified at S/W Revision	A.03.00

Auto Couple

The Auto Couple feature provides a quick and convenient way to automatically couple multiple instrument settings. This helps ensure accurate measurements and optimum dynamic range. When the Auto Couple feature is activated, either from the front panel or remotely, all parameters of the current measurement that have an Auto/Manual mode are set to Auto mode and all measurement settings dependent on (or coupled to) the Auto/Man parameters are automatically adjusted for optimal performance.

However, the Auto Couple keyactions are confined to the current measurement only. It does not affect other measurements in the mode, and it does not affect markers, marker functions, or trace or display attributes.

See "[More Information](#)" on page 1218

Key Path	Front-panel key
Remote Command	:COUPle ALL NONE
Example	:COUP ALL
Notes	:COUPle ALL puts all Auto/Man parameters in Auto mode (equivalent to pressing the Auto Couple key). :COUPLE NONE puts all Auto/Man parameters in manual mode. It decouples all the coupled instrument parameters and is not recommended for making measurements.
Initial S/W Revision	Prior to A.02.00

More Information

There are two types of functions that have Auto/Manual modes.

Auto/Man Active Function keys

An Auto/Man toggle key controls the binary state associated with an instrument parameter by toggling between Auto (where the parameter is automatically coupled to the other parameters it is dependent upon) and Man (where the parameter is controlled independent of the other parameters), as well as making the parameter the active function. The current mode is indicated on the softkey with either Auto or Man underlined as illustrated below.

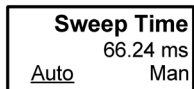

vsd07

Auto/Man 1-of-N keys

An Auto/Man 1-of-N key allows you to manually pick from a list of parameter values, or place the function in Auto, in which case the value is automatically selected (and indicated) as shown below. If in Auto, Auto is underlined on the calling key. If in manual operation, manual is indicated on the calling key. But the calling key does not actually toggle the function, it simply opens the menu.

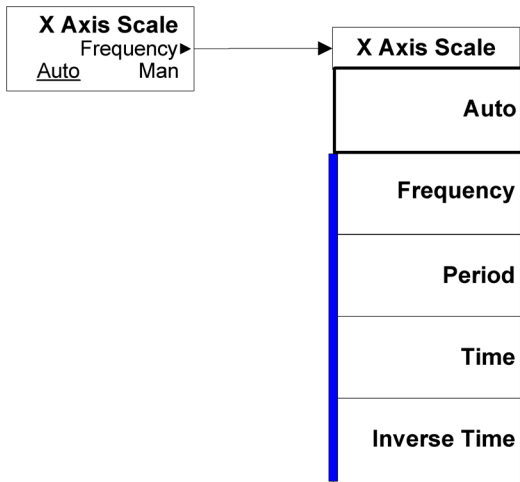

vsd08

BW

Accesses a menu of functions that enable you to specify and control the video and resolution bandwidths. You can also select the type of filter for the measurement.

Key Path	Front-panel key
Initial S/W Revision	Prior to A.02.00

Res BW

Sets the resolution bandwidth for the current measurement. If an unavailable bandwidth is entered with the numeric keypad, the closest available bandwidth is selected.

Key Path	BW
Mode	SA, WCDMA, C2K, WIMAX OFDMA, TD-SCDMA, 1xEVDO, ISDB-T, CMMB, LTE, LTETDD, BLUETOOTH, WLAN, MSR, LTEAFDD, LTEATDD
Remote Command	[:SENSE]:OBWidth:BANDwidth[:RESolution] <bandwidth> [:SENSE]:OBWidth:BANDwidth[:RESolution]? [:SENSE]:OBWidth:BANDwidth[:RESolution]:AUTO ON OFF 1 0 [:SENSE]:OBWidth:BANDwidth[:RESolution]:AUTO?
Example	OBW:BAND 250000 OBW:BAND? OBW:BAND:AUTO OFF OBW:BAND:AUTO?
Notes	You must be in the Spectrum Analysis mode, W-CDMA mode, cdma2000 mode, TD-SCDMA mode, ISDB-T mode, CMMB mode, LTE mode, LTE TDD mode, BLUETOOTH mode, WLAN mode, 1xEVDO mode, MSR, LTE-Advanced FDD/TDD or WIMAX OFDMA mode to use this command. Use:INSTrument:SElect to set the mode.
Couplings	Sweep time is coupled to RBW. As the RBW changes, the sweep time (if set to Auto) is changed to maintain amplitude calibration. Video bandwidth (VBW) is coupled to RBW. As the resolution bandwidth changes, the video bandwidth (if set to Auto) changes to maintain the ratio of VBW/RBW (10:1). When Res BW is set to Auto, the resolution bandwidth is auto-coupled to span. The ratio of Span/RBW is approximately 106:1 when auto coupled. When Res BW is set to Man, bandwidths are entered manually, and these bandwidths are used regardless of other analyzer settings.
Preset	SA: Auto WCDMA: 30 kHz CDMA2K: 12 kHz WIMAX OFDMA: 100 kHz TD-SCDMA: 30 kHz 1xEVDO: 30 kHz ISDB-T: 10 kHz

	CMMB: 3 kHz LTE: 30 kHz LTETDD: 30 kHz BLUETOOTH:10 kHz WLAN: 100kHz MSR: 30 kHz, LTEAFDD, LTEATDD: 30 kHz SA: ON WCDMA, C2K, TD-SCDMA, WIMAX OFDMA, 1xEVDO , ISDB-T, CMMB, LTE, LTETDD, WLAN, MSR, LTEAFDD, LTEATDD: OFF
State Saved	Saved in instrument state.
Min	1 Hz
Max	8 MHz
Backwards Compatibility SCPI	<code>[:SENSe] :OBWidth :BWIDth [:RESolution]</code>
Initial S/W Revision	Prior to A.02.00
Modified at S/W Revision	A.03.00

Video BW

Changes the analyzer post-detection filter.

Key Path	BW
Mode	SA, WCDMA, C2K, WIMAX OFDMA, TD-SCDMA, 1xEVDO, ISDB-T, CMMB, LTE, LTETDD, BLUETOOTH, WLAN, MSR, LTEAFDD, LTEATDD
Remote Command	<code>[:SENSe] :OBWidth :BANDwidth :VIDeo <bandwidth></code> <code>[:SENSe] :OBWidth :BANDwidth :VIDeo?</code> <code>[:SENSe] :OBWidth :BANDwidth :VIDeo :AUTO ON OFF 1 0</code> <code>[:SENSe] :OBWidth :BANDwidth :VIDeo :AUTO?</code>
Example	<code>OBW:BAND:VID 5 MHz</code> <code>OBW:BAND:VID?</code> <code>OBW:BAND:VID:AUTO ON</code> <code>OBW:BAND:VID:AUTO?</code>
Notes	You must be in the Spectrum Analysis mode, W-CDMA mode, cdma2000 mode, TD-SCDMA mode, ISDB-T mode, CMMB mode, LTE mode, LTE TDD mode, BLUETOOTH mode, WLAN mode, 1xEVDO mode, MSR, LTE-Advanced FDD/TDD or WIMAX OFDMA mode to use this command. Use: INSTRUMENT:SELEct to set the mode.
Dependencies	When using the average detector with either Sweep Time set to Man, or in zero span, the VBW setting has no effect and is disabled (grayed out).
Couplings	Video bandwidth (VBW) is coupled to RBW. As the resolution bandwidth changes, the video bandwidth (if set to Auto) changes to maintain the ratio set by VBW/RBW.

Sweep Time is coupled to Video Bandwidth (VBW). As the VBW is changed, the sweep time (when set to Auto) is changed to maintain amplitude calibration. This occurs because of common hardware between the two circuits, even though the Video BW filter is not actually “in-circuit” when the detector is set to Average. Because the purpose of the average detector and the VBW filter are the same, either can be used to reduce the variance of the result.

Although the VBW filter is not “in-circuit” when using the average detector, the Video BW key can have an effect on (Auto) sweep time, and is not disabled. In this case, reducing the VBW setting increases the sweep time, which increases the averaging time, producing a lower-variance trace.

When the video bandwidth is AUTO coupled, the video bandwidth value is set to:

Resolution Bandwidth * Video Bandwidth to Resolution Bandwidth Ratio

Preset	SA, LTE, LTETDD, WLAN, MSR, LTEAFDD, LTEATDD: Auto WCDMA: 300 kHz CDMA2K:120 kHz WIMAX OFDMA: 1 MHz TD-SCDMA: 300 kHz 1xEVDO: 300 kHz ISDB-T: 300 Hz CMMB: 3 kHz BLUETOOTH: 30 kHz ON ISDB-T, CMMB: OFF
State Saved	Saved in instrument state.
Min	1 Hz
Max	50 MHz
Backwards Compatibility SCPI	[:SENSe] :OBWidth :BWIDth :VIDeo
Initial S/W Revision	Prior to A.02.00
Modified at S/W Revision	A.03.00

Filter Type

Allows you to select the type of filter to be used for the current measurement. Besides the Gaussian filter shape, there are certain special filter types, such as Flat Top, that are desirable under certain conditions.

Key Path	BW
Mode	SA, WCDMA, C2K, WIMAX OFDMA, TD-SCDMA, 1xEVDO, ISDB-T, CMMB, LTE, LTETDD, BLUETOOTH, WLAN, MSR, LTEAFDD, LTEATDD
Remote Command	[:SENSe] :OBWidth :BANDwidth :SHAPE GAUSSian FLATtop [:SENSe] :OBWidth :BANDwidth :SHAPE?
Example	OBW:BAND:SHAP GAUS

	OBW:BAND:SHAP?
Preset	GAUSSian
State Saved	Saved in instrument state.
Range	Gaussian Flattop
Backwards Compatibility SCPI	[:SENSe] :OBwidth:BWIDth:SHApe
Initial S/W Revision	Prior to A.02.00
Modified at S/W Revision	A.03.00

Cont (Continuous Measurement/Sweep)

Sets the analyzer for Continuous measurement operation. The single/continuous state is Meas Global so the setting will affect all measurements. If you are Paused, pressing Cont does a Resume.

Key Path	Front-panel key
Remote Command	:INITiate:CONTinuous OFF ON 0 1 :INITiate:CONTinuous?
Example	:INIT:CONT 0 puts analyzer in Single measurement operation. :INIT:CONT 1 puts analyzer in Continuous measurement operation
Preset	ON (Note that SYST:PRESet sets INIT:CONT to ON but *RST sets INIT:CONT to OFF)
State Saved	Saved in instrument state
Backwards Compatibility Notes	For Spectrum Analysis mode in ESA and PSA, there is no Cont hardkey, instead there is a Sweep Single/Cont key. In these analyzers, switching the Sweep Single/Cont key from Single to Cont restarts averages (displayed average count reset to 1), but does not restart Max Hold and Min Hold. The X-Series has Single and Cont keys in place of the SweepSingleCont key. In the X-Series, if in single measurement, the Cont key (and INIT:CONT ON) switches to continuous measurement, but never restarts a measurement and never resets a sweep.
Initial S/W Revision	Prior to A.02.00

In Swept SA Measurement (Spectrum Analysis Mode):

The analyzer takes repetitive sweeps, averages, measurements, etc., when in Continuous mode. When the average count reaches the Average/Hold Number the count stops incrementing, but the analyzer keeps sweeping. See the Trace/Detector section for the averaging formula used both before and after the Average/Hold Number is reached. The trigger condition must be met prior to each sweep. The type of trace processing for multiple sweeps, is set under the Trace/Detector key, with choices of Trace Average, Max Hold, or Min Hold.

In Other Measurements/Modes:

With Avg/Hold Num (in the Meas Setup menu) set to Off or set to On with a value of 1, a sweep is taken after the trigger condition is met; and the analyzer continues to take new sweeps after the current sweep has completed and the trigger condition is again met. However, with Avg/Hold Num set to On with a value >1, multiple sweeps (data acquisitions) are taken for the measurement. The trigger condition must be met prior to each sweep. The sweep is not stopped when the average count k equals the number N set for Avg/Hold Num is reached, but the number k stops incrementing. A measurement average usually applies to all traces, marker results, and numeric results. But sometimes it only applies to the numeric results.

If the analyzer is in Single measurement, pressing the Cont key does not change k and does not cause the sweep to be reset; the only action is to put the analyzer into Continuous measurement operation.

If it is already in continuous sweep:

the INIT:CONT 1 command has no effect

the INIT:CONT 0 command will place the analyzer in Single Sweep but will have no effect on the current sequence until $k = N$, at which point the current sequence will stop and the instrument will go to the idle state.

Display

Accesses a menu of functions that enable you to set the display parameters.

See Display@3440 for more information.

Key Path	View/Display
Initial S/W Revision	Prior to A.02.00

Display

The Display menu is common to most measurements, and is used for configuring items on the display. Some Display menu settings apply to all the measurements in a mode, and some only to the current measurement. Those under the System Display Settings key apply to all measurements in all modes.

Key Path	Display
Key Path	View/Display
Initial S/W Revision	Prior to A.02.00

Annotation

Turns on and off various parts of the display annotation. The annotation is divided up into four categories:

1. Meas Bar: This is the measurement bar at the top of the screen. It does not include the settings panel or the Active Function. Turning off the Meas Bar turns off the settings panel and the Active Function. When the Meas Bar is off, the graticule area expands to fill the area formerly occupied by the Meas Bar.
2. Screen Annotation: this is the annotation and annunciation around the graticule, including any annotation on lines (such as the display line, the threshold line, etc.) This does NOT include the marker number or the N dB result. When off, the graticule expands to fill the entire graticule area.
3. Trace annotation: these are the labels on the traces, showing their detector (or their math mode).
4. Active Function annotation: this is the active function display in the meas bar, and all of the active function values displayed on softkeys.

See the figure below. Each type of annotation can be turned on and off individually.

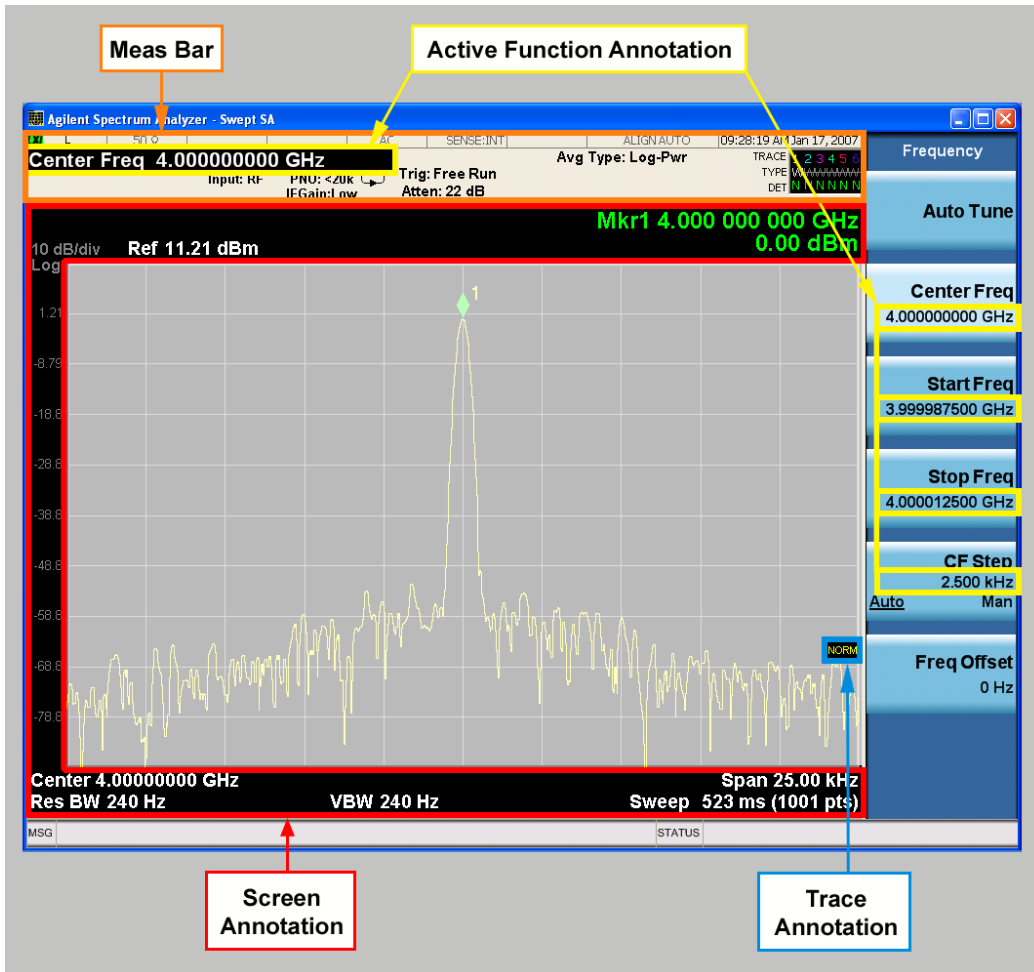

Key Path	View/Display, Display
Initial S/W Revision	Prior to A.02.00

Meas Bar On/Off

This function turns the Measurement Bar on and off, including the settings panel. When off, the graticule area expands to fill the area formerly occupied by the Measurement Bar.

Key Path	View/Display, Display, Annotation
Remote Command	:DISPlay:ANNotation:MBAR[:STATE] OFF ON 0 1 :DISPlay:ANNotation:MBAR[:STATE]?
Example	DISP:ANN:MBAR OFF
Dependencies	Grayed out and forced to OFF when System Display Settings, Annotation is set to Off.
Preset	On This should remain Off through a Preset when System DisplaySettings, Annotation is set to Off.

State Saved	Saved in instrument state.
Initial S/W Revision	Prior to A.02.00

Screen

This controls the display of the annunciation and annotation around the graticule, including any annotation on lines (such as the display line, the threshold line, etc.) and the y-axis annotation. This does NOT include marker annotation (or the N dB result). When off, the graticule expands to fill the entire graticule area, leaving only the 1.5% gap above the graticule as described in the Trace/Detector chapter.

Key Path	View/Display, Display, Annotation
Remote Command	:DISPlay:ANNotation:SCReen[:STATe] OFF ON 0 1 :DISPlay:ANNotation:SCReen[:STATe]?
Example	DISP:ANN:SCR OFF
Dependencies	Grayed-out and forced to OFF when System Display Settings, Annotation is set to Off.
Preset	On This should remain Off through a Preset when System DisplaySettings, Annotation is set to Off
State Saved	Saved in instrument state.
Initial S/W Revision	Prior to A.02.00

Active Function Values On/Off

Turns on and off the active function display in the Meas Bar, and all of the active function values displayed on the softkeys.

Note that all of the softkeys that have active functions have these numeric values blanked when this function is on. This is a security feature..

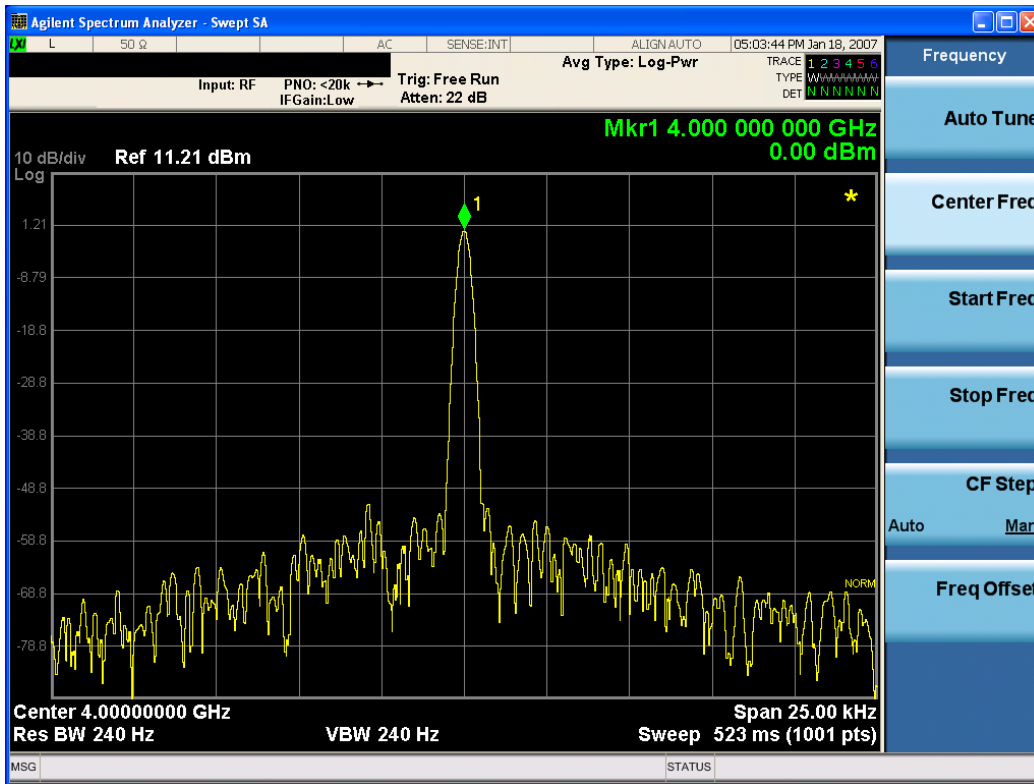

Key Path	View/Display, Display, Annotation
Remote Command	:DISPlay:ACTivefunc[:STATE] ON OFF 1 0 :DISPlay:ACTivefunc[:STATE]?
Example	DISP:ACT OFF
Dependencies	Grayed out and forced to OFF when System Display Settings, Annotation is set to Off.
Preset	On This should remain Off through a Preset when System DisplaySettings, Annotation is set to Off
State Saved	Saved in instrument state.
Initial S/W Revision	Prior to A.02.00

Title

Displays menu keys that enable you to change or clear a title on your display.

Key Path	View/Display, Display
Initial S/W Revision	Prior to A.02.00

Change Title

Writes a title into the "measurement name" field in the banner, for example, "Swept SA".

Press Change Title to enter a new title through the alpha editor. Press Enter or Return to complete the entry. Press ESC to cancel the entry and preserve your existing title.

The display title will replace the measurement name. It remains for this measurement until you press Change Title again, or you recall a state, or a Preset is performed. A title can also be cleared by pressing Title, Clear Title.

NOTE

Notice the inclusion of the <measurement> parameter in the command below. Because each measurement remembers the Display Title, the command must be qualified with the measurement name. For the Swept SA measurement this is not the case; no <measurement> parameter is used when changing the Display Title for the Swept SA measurement.

Key Path	View/Display, Display, Title
Mode	All
Remote Command	:DISPlay:<measurement>:ANNotation:TITLe:DATA <string> :DISPlay:<measurement>:ANNotation:TITLe:DATA?
Example	DISP:ANN:TITL:DATA "This Is My Title" This example is for the Swept SA measurement in the Spectrum Analyzer mode. The SANalyzer <measurement> name is not used. DISP:ACP:ANN:TITL:DATA "This Is My Title" This example is for Measurements other than Swept SA. Both set the title to: This Is My Title
Notes	Pressing this key cancels any active function. When a title is edited the previous title remains intact (it is not cleared) and the cursor goes at the end so that characters can be added or BKSP can be used to go back over previous characters.
Preset	No title (measurement name instead)
State Saved	Saved in instrument state.
Initial S/W Revision	Prior to A.02.00

Clear Title

Clears a title from the front-panel display. Once cleared, the title cannot be retrieved. After the title is cleared, the current Measurement Name replaces it in the title bar.

Key Path	View/Display, Display, Title
Example	The following commands clear the title and restore the measurement's original title: DISP:ANN:TITL:DATA "" This example is for the Swept SA measurement in the Spectrum Analyzer mode. The SANalyzer <measurement> name is not used. DISP:ACP:ANN:TITL:DATA "" This example is for ACP; in measurements other than Swept SA the measurement name is required.
Notes	Uses the :DISPlay:<measurement>:ANNotation:TITLe:DATA <string> command with an empty string (in the Swept SA, the <measurement> is omitted).

Preset	Performed on Preset.
Initial S/W Revision	Prior to A.02.00

Graticule

Pressing Graticule turns the display graticule On or Off. It also turns the graticule y-axis annotation on and off.

Key Path	View/Display, Display
Remote Command	:DISPlay:WINDow[1]:TRACe:GRATicule:GRID[:STATe] OFF ON 0 1 :DISPlay:WINDow[1]:TRACe:GRATicule:GRID[:STATe]?
Example	DISP:WIND:TRAC:GRAT:GRID OFF
Notes	The graticule is the set of horizontal and vertical lines that make up the grid/divisions for the x-axis and y-axis.
Preset	On
State Saved	Saved in instrument state
Initial S/W Revision	Prior to A.02.00

System Display Settings

These settings are "Mode Global" – they affect all modes and measurements and are reset only by Restore Misc Defaults or Restore System Defaults under System.

Key Path	View/Display, Display
Initial S/W Revision	Prior to A.02.00

Annotation Local Settings

This is a Mode Global override of the meas local annotation settings. When it is All Off, it forces ScreenAnnotation, Meas Bar, Trace, and Active Function Values settings to be OFF for all measurements in all modes. This provides the security based "annotation off" function of previous analyzers; hence it uses the legacy SCPI command.

When it is All Off, the Screen, Meas Bar, Trace, and Active Function Values keys under the Display, Annotation menu are grayed out and forced to Off. When Local Settings is selected, you are able to set the local annotation settings on a measurement by measurement basis.

Key Path	View/Display, Display, System Display Settings
Remote Command	:DISPlay:WINDow[1]:ANNOtation[:ALL] OFF ON 0 1 :DISPlay:WINDow[1]:ANNOtation[:ALL]?
Example	:DISP:WIND:ANN OFF

Preset	On (Set by Restore Misc Defaults)
State Saved	Not saved in instrument state.
Backwards Compatibility Notes	The WINDOW parameter and optional subopcode is included for backwards compatibility but ignored - all windows are equally affected.
Initial S/W Revision	Prior to A.02.00

Themes

Accesses a menu of functions that enable you to choose the theme to be used when saving the screen image.

The **Themes** option is the same as the **Themes** option under the **Display** and **Page Setup** dialogs. It allows you to choose between themes to be used when saving the screen image.

Key Path	Save, Screen Image
Remote Command	:MMEMory:STORe:SCReen:THEMe TDColor TDMonochrome FCOLor FMONochrome :MMEMory:STORe:SCReen:THEMe?
Example	:MMEM:STOR:SCR:THEM TDM
Preset	3D Color; Is not part of Preset, but is reset by Restore Misc Defaults or Restore System Defaults All and survives subsequent running of the modes.
Readback	3D Color 3D Mono Flat Color Flat Mono
Backwards Compatibility Notes	In ESA and PSA we offer the choice of "Reverse Bitmap" or "Reverse Metafile" when saving screen images. This is much like the "Flat Color" theme available in X-Series. Also, if you selected Reverse Bitmap AND a black & white screen image, that would be much like "Flat Monochrome". In other words, each of the X-Series themes has a similar screen image type in ESA/PSA. But they are not identical.
Initial S/W Revision	Prior to A.02.00

3D Color

Selects a standard color theme with each object filled, shaded and colored as designed.

Key Path	Save, Screen Image, Themes
Example	MMEM:STOR:SCR:THEM TDC
Readback	3D Color
Initial S/W Revision	Prior to A.02.00

3D Monochrome

Selects a format that is like 3D color but shades of gray are used instead of colors.

Key Path	Save, Screen Image, Themes
Example	MMEM:STOR:SCR:THEM TDM
Readback	3D Mono
Initial S/W Revision	Prior to A.02.00

Flat Color

Selects a format that is best when the screen is to be printed on an ink printer.

Key Path	Save, Screen Image, Themes
Example	MMEM:STOR:SCR:THEM FCOL
Readback	Flat Color
Initial S/W Revision	Prior to A.02.00

Flat Monochrome

Selects a format that is like Flat Color. But only black is used (no colors, not even gray), and no fill.

Key Path	Save, Screen Image, Themes
Example	MMEM:STOR:SCR:THEM FMON
Readback	Flat Mono
Initial S/W Revision	Prior to A.02.00

Boundary Frequency

Selects frequency display type from either Offset or Absolute:

- **OFFSet**: offsets from Center Freq to OBW boundary frequency are displayed.
- **ABSolute**: absolute frequencies are displayed.

Key Path	View/Display, OBW Boundaries
Remote Command	:DISPlay:OBwidth:VIEW2:WINDow2:BOUNdaries:FREQuency OFFSet ABSolute :DISPlay:OBwidth:VIEW2:WINDow2:BOUNdaries:FREQuency?
Example	DISP:OBW:VIEW2:WIND2:BOUN:FREQ ABS DISP:OBW:VIEW2:WIND2:BOUN:FREQ?
Preset	OFFSet
State Saved	Saved in instrument state
Range	Offset Absolute
Initial S/W Revision	A.16.00

x dB BW Boundaries

Turns the x dB BW Boundaries On and Off.

Key Path	View/Display
Remote Command	:DISPlay:OBWidth:VIEW:WINDow[1]:XDB 0 1 OFF ON :DISPlay:OBWidth:VIEW:WINDow[1]:XDB?
Example	DISP:OBW:VIEW:WIND:XDB 1 DISP:OBW:VIEW:WIND:XDB?
Preset	0
State Saved	Saved in instrument state
Range	On Off
Initial S/W Revision	A.16.00

File

See "File" on page 184

FREQ Channel

Accesses a menu of keys that allow you to control the Frequency and Channel parameters of the instrument.

Some features in the Frequency menu are the same for all measurements – they do not change as you change measurements. Settings like these are called “Meas Global” and are unaffected by Meas Preset. For example, the Center Freq setting is the same for all measurements - it does not change as you change measurements.

Key Path	Front-panel key
Initial S/W Revision	Prior to A.02.00

Center Freq

Sets the frequency that corresponds to the horizontal center of the graticule (when frequency Scale Type is set to linear). While adjusting the Center Frequency the Span is held constant, which means that both Start Frequency and Stop Frequency will change.

Pressing Center Freq also sets the frequency entry mode to Center/Span. In Center/Span mode, the center frequency and span values are displayed below the graticule, and the default active function in the Frequency menu is Center Freq.

The center frequency setting is the same for all measurements within a mode, that is, it is Meas Global. Some modes are also able to share a Mode Global center frequency value. If this is the case, the Mode will have a Global Settings key in its Mode Setup menu.

The Center Freq function sets (and queries) the Center Frequency for the currently selected input. If your analyzer has multiple inputs, and you select another input, the Center Freq changes to the value for that input. SCPI commands are available to directly set the Center Freq for a specific input.

Center Freq is remembered as you go from input to input. Thus you can set a Center Freq of 10 GHz with the RF Input selected, change to BBIQ and set a Center Freq of 20 MHz, then switch to External Mixing and set a Center Freq of 60 GHz, and when you go back to the RF Input the Center Freq will go back to 10 GHz; back to BBIQ and it is 20 MHz; back to External Mixing and it is 60 GHz.

See ["RF Center Freq" on page 1239](#)

See [Ext Mix Center Freq](#)

See ["I/Q Center Freq" on page 1241](#)

See ["Center Frequency Presets" on page 1237](#)

Key Path	FREQ Channel
Scope	Meas Global
Remote Command	<code>[:SENSe] :FREQuency:CENTer <freq></code> <code>[:SENSe] :FREQuency:CENTer?</code>
Example	<code>FREQ:CENT 50 MHz</code>

	FREQ:CENT UP changes the center frequency to 150 MHz if you use FREQ:CENT:STEP 100 MHz to set the center frequency step size to 100 MHz FREQ:CENT?
Notes	This command sets either the RF or I/Q Center Frequency depending on the selected input. For RF input it is equivalent to FREQ:RF:CENT For I/Q input it is equivalent to FREQ:IQ:CENT Preset and Max values are dependent on Hardware Options (5xx) If no terminator (e.g. MHz) is sent the terminator Hz is used. If a terminator with unit other than Frequency is used, an invalid suffix error message is generated.
Dependencies	The Center Frequency can be limited by Start or Stop Freq limits, if the Span is so large that Start or Stop reach their limit.
Couplings	When operating in "swept span", any value of the Center Frequency or Span that is within the frequency range of the analyzer is allowed when the value is being set through the front panel numeric key pad or the SCPI command. The other parameter is forced to a different value if needed, to keep the Start and the Stop Frequencies within the analyzer's frequency range
Preset	Depends on instrument maximum frequency, mode, measurement, and selected input. See "Center Frequency Presets" on page 1237 and "RF Center Freq" on page 1239 and Ext Mix Center Freq and "I/Q Center Freq" on page 1241.
State Saved	Saved in instrument state
Min	Depends on instrument maximum frequency, mode, measurement, and selected input.. See "Center Frequency Presets" on page 1237 and "RF Center Freq" on page 1239 and "I/Q Center Freq" on page 1241.
Max	Depends on instrument maximum frequency, mode, measurement, and selected input.. See "Center Frequency Presets" on page 1237 and "RF Center Freq" on page 1239 and "I/Q Center Freq" on page 1241.
Default Unit	Hz
Status Bits/OPC	Non-overlapped
Dependencies	
Initial S/W Revision	Prior to A.02.00

Center Frequency Presets

The following table provides the Center Frequency Presets for the Spectrum Analyzer mode, and the Max Freq, for the various frequency options:

Freq Option	CF after Mode Preset	Stop Freq after Mode Preset	Max Freq (can't tune above)

11 Occupied Bandwidth Measurement
FREQ Channel

503 (all but N9000A)	1.805 GHz	3.6 GHz	3.7 GHz
503 (N9000A)	1.505 GHz	3.0 GHz	3.08 GHz
504 (M9420A)	1 GHz	3.8GHz	3.88 GHz
506 (M9420A)	1 GHz	6.0GHz	6.08 GHz
507 (all but N9000A)	3.505 GHz	7.0 GHz	7.1 GHz
507 (N9000A)	3.755 GHz	7.5 GHz	7.58 GHz
508 (all but N9038A)	1.805 GHz	3.6 GHz	8.5 GHz
508 (N9038A)	4.205 GHz	8.4 GHz	8.5 GHz
513	6.805 GHz	13.6 GHz	13.8 GHz
526 (all but N9000A and N9038A)	13.255 GHz	26.5 GHz	27.0 GHz
526 (N9000A)	13.255 GHz	26.5 GHz	26.55 GHz
526 (N9038A)	1.805 GHz	3.6 GHz	27.0 GHz
532	16.005 GHz	32.0 GHz	32.5 GHz
543	21.505 GHz	43.0 GHz	TBD
544	22.005 GHz	44.0 GHz	44.5 GHz
550	25.005 GHz	50.0 GHz	51 GHz

Input 2:

Model	CF after Mode Preset	Stop Freq after Mode Preset	Max Freq (can't tune above)
N9000A opt C75	0.7505GHz	1.5 GHz	1.58 GHz
N9038A	505 MHz	1 GHz	1.000025 GHz

Tracking Generator Frequency Limits (N9000A only):

Tracking Generator Option	Min Freq (clips to this freq when turn TG on and can't tune below while TG on)	If above this Freq, Stop Freq clipped to this Freq when TG turned on	Max Freq (can't tune above) while TG on
T03	9 kHz	3.0 GHz	3.08 GHz
T06	9 kHz	6.0 GHz	6.05 GHz

The following table shows the Center Frequency Presets for modes other than Spectrum Analyzer:

Mode	CF Preset for RF
WCDMA	1 GHz
WIMAXOFDMA,	1 GHz
BASIC	1 GHz
ADEMOD	1 GHz
VSA	1 GHz
TDSCDMA	1 GHz
PNOISE	1 GHz
LTE	1 GHz
LTETDD	1 GHz
MSR	1 GHz
GSM	935.2 MHz
NFIGURE	1.505 GHz

RF Center Freq

SCPI command for specifying the RF Center Frequency. This command will set the Center Frequency to be used when the RF input is selected, even if the RF input is not the input that is selected at the time the command is sent. Note that the Center Freq function in the Frequency menu on the front panel always applies to the currently selected input.

Scope	Meas Global
Remote Command	<code>[:SENSe] :FREQuency:RF:CENTer <freq></code> <code>[:SENSe] :FREQuency:RF:CENTer?</code>
Example	FREQ:RF:CENT 30 MHz
Notes	This command is the same in all modes, but the parameter is Measurement Global. So the value is independent in each mode and common across all the measurements in the mode.
Dependencies	If the electronic/soft attenuator is enabled, any attempt to set Center Frequency such that the Stop Frequency would be >3.6 GHz fails and results in an advisory message. If the equivalent SCPI

	command is sent, this same message is generated as part of a “-221, Settings conflict” warning. If Source Mode is set to Tracking, and the Max or Min Center Freq is therefore limited by the limits of the source, a warning message is generated, “Data out of range;clipped to source max/min” if these limits are exceeded. Note that for an external source, these limits can be affected by the settings of Source Numerator, Source Denominator and Power Sweep.
Preset	See table above
State Saved	Saved in instrument state.
Min	-79.999995 MHz, unless Source Mode is set to Tracking, in which case it is limited by the minimum frequency of the Source
Max	See table above. Basically instrument maximum frequency – 5 Hz. Note that, if the Source Mode is set to Tracking, the effective instrument maximum frequency may be limited by the source maximum frequency. If the knob or step keys are being used, also depends on the value of the other three interdependent parameters Span, Start Frequency and Stop Frequency
Initial S/W Revision	Prior to A.02.00
Modified at S/W Revision	A.03.00

Ext Mix Center Freq

SCPI command for specifying the External Mixer Center Frequency. This command will set the Center Frequency to be used when the External Mixer is selected, even if the External Mixer input is not the input which is selected at the time the command is sent. Note that the Center Freq function in the Frequency menu on the front panel always applies to the currently selected input.

Scope	Meas Global
Remote Command	<code>[:SENSE] :FREQuency:EMIXer:CENTer <freq></code> <code>[:SENSE] :FREQuency:EMIXer:CENTer?</code>
Example	<code>:FREQ:EMIX:CENT 60 GHz</code> <code>:FREQ:EMIX:CENT?</code>
Notes	This command is the same in all modes, but the parameter is Measurement Global. So the value is independent in each mode and common across all the measurements in the mode.
Couplings	When returning to External Mixing after having been switched to one of the other inputs (e.g., RF), you will come back into the settings that you had when you left External Mixing. So you will come back to the band you were in with the Center Frequency that you had. However, Span is not an input-dependent parameter, therefore you will bring the span over from the other input. Therefore, the analyzer comes back with the span from the previous input, limited as necessary by the current mixer setup.
Preset	When a Mode Preset is performed while in External Mixing, the Start frequency of the current Mode is set to the nominal Min Freq of the lowest harmonic range in the Harmonic Table for the current mixer setup. Similarly, the Stop frequency of the current Mode is set to the nominal Max Freq of the highest harmonic range in the Harmonic Table. The Center Freq thus presets to the point arithmetically equidistant from these two frequencies.

	<p>If the current measurement has a limited Span available to it, and cannot achieve the Span shown in the table (Span=Stop Freq - Start Freq), the analyzer uses the maximum Span the measurement allows, and still sets the Center Freq to the midpoint of the Start and Stop Freq values in the Harmonic Table.</p> <p>When Restore Input/Output Defaults is performed, the mixer presets to the 11970A, whose Start and Stop frequencies are 26.5 and 40 GHz respectively. The center of these two frequencies is 33.25 GHz.</p> <p>Therefore, after a Restore Input/Output Defaults, if you go into External Mixing and do a Mode Preset while in the Spectrum Analyzer Mode, the resulting Center Freq is 33.25 GHz.</p>
State Saved	Saved in instrument state.
Min	The minimum frequency in the currently selected mixer band + 5 Hz
Max	The maximum frequency in the currently selected mixer band - 5 Hz If the knob or step keys are being used, also depends on the value of the other three interdependent parameters Span, Start Frequency and Stop Frequency
Initial S/W Revision	A.08.01

I/Q Center Freq

SCPI command for specifying the I/Q Center Frequency. This command will set the Center Frequency to be used when the I/Q input is selected, even if the I/Q input is not the input which is selected at the time the command is sent. Note that the Center Freq function in the Frequency menu on the front panel always applies to the currently selected input.

Scope	Meas Global
Remote Command	[:SENSe] :FREQuency:IQ:CENTer <freq> [:SENSe] :FREQuency:IQ:CENTer?
Example	FREQ:IQ:CEN: 30 MHz
Notes	This command is the same in all modes, but the parameter is Measurement Global. So the value is independent in each mode and common across all the measurements in the mode.
Preset	0 Hz
State Saved	Saved in instrument state.
Min	-40.049995 MHz
Max	40.049995 MHz
Initial S/W Revision	Prior to A.02.00

CF Step

Changes the step size for the center frequency and start and stop frequency functions. Once a step size has been selected and the center frequency function is active, the step keys (and the UP|DOWN parameters for Center Frequency from remote commands) change the center frequency by the step-size value. The step size function is useful for finding harmonics and sidebands beyond the current frequency span of the analyzer.

Note that the start and stop frequencies also step by the CF Step value.

Key Path	FREQ Channel
Remote Command	[:SENSe]:FREQuency:CENTer:STEP[:INCRement] <freq> [:SENSe]:FREQuency:CENTer:STEP[:INCRement]? [:SENSe]:FREQuency:CENTer:STEP:AUTO OFF ON 0 1 [:SENSe]:FREQuency:CENTer:STEP:AUTO?
Example	FREQ:CENt:STEP:AUTO ON FREQ:CENt:STEP 500 MHz FREQ:CENt UP increases the current center frequency value by 500 MHz FREQ:CENt:STEP? FREQ:CENt:STEP:AUTO?
Notes	Preset and Max values are depending on Hardware Options (503, 507, 508, 513, 526)
Notes	Preset and Max values are dependent on Hardware Options (5xx)
Dependencies	Freq Offset is not available in External Mixing. In this case the Freq Offset key is grayed out and shows a value of zero. It will once again be available, and show the previously set value, when you return to the RF Input.
Dependencies	Span, RBW, Center frequency If the electronic/soft attenuator is enabled, any attempt to change the value of the center frequency >3.6 GHz by pressing the Up-arrow key, fails and results in an advisory message. If the equivalent SCPI command is sent, this same message is generated as part of a “-221, Settings conflict” warning.
Couplings	When auto-coupled in a non-zero span, the center frequency step size is set to 10% of the span. When auto-coupled in zero span, the center frequency step size is set to the equivalent -3 dB RBW value.
Preset	Auto ADEMOD: 1 MHz ON
State Saved	Saved in instrument state
Min	– (the maximum frequency of the instrument). That is, 27 GHz max freq instrument has a CF step range of +/- 27 GHz. Note that this is the maximum frequency given the current settings of the instrument, so in External Mixing, for example, it is the maximum frequency of the current mixer band.
Max	The maximum frequency of the instrument. That is, 27 GHz max freq instrument has a CF step range of +/- 27 GHz. Note that this is the maximum frequency given the current settings of the instrument, so in External Mixing, for example, it is the maximum frequency of the current mixer band.
Default Unit	Hz
Status Bits/OPC dependencies	non-overlapped
Initial S/W Revision	Prior to A.02.00
Modified at S/W Revision	A.03.00

11 Occupied Bandwidth Measurement
Input/Output

Input/Output

See "[Input/Output](#)" on page 138

Marker

Accesses a menu that enables you to select, set up and control the markers for the current measurement.

Key Path	Front-panel key
Initial S/W Revision	Prior to A.02.00

Select Marker

Displays the menu keys that enable you to select, set up and control the markers for the current measurement

Key Path	Marker
Initial S/W Revision	Prior to A.02.00

Select Marker

Displays 12 markers available for selection.

Key Path	Marker, Properties
Initial S/W Revision	Prior to A.02.00

Marker Type

Sets the marker control mode to Normal, Delta or Off, If the selected marker is Off, pressing Marker sets it to Normal and places a single marker at the center of the display. At the same time, Marker X Axis Value appears on the Active Function area.

Key Path	Marker
Mode	SA, WCDMA, C2K, WIMAX OFDMA, TD-SCDMA, 1xEVDO, ISDB-T, CMMB, LTE, LTETDD, BLUETOOTH, WLAN, MSR, LTEAFDD, LTEATDD
Remote Command	:CALCulate:OBWidth:MARKer[1] 2 ... 12:MODE POSition DELTa OFF :CALCulate:OBWidth:MARKer[1] 2 ... 12:MODE?
Example	CALC:OBW:MARK:MODE POS CALC:OBW:MARK:MODE?
Notes	If the selected marker is Off, pressing Marker sets it to Normal and places it at the center of the screen on the trace determined by the Marker Trace rules. At the same time, Marker X Axis Value appears on the Active Function area. Default Active Function: the active function for the selected marker's current control mode. If the current control mode is Off, there is no active function and the active function is turned off. Active Function Display: the marker X axis value entered in the active function area displays the marker value to its full entered precision.

Preset	OFF
State Saved	Saved in instrument state.
Range	Normal Delta Off
Initial S/W Revision	Prior to A.02.00
Modified at S/W Revision	A.03.00

Properties

Accesses the marker properties menu.

Key Path	Marker
Initial S/W Revision	Prior to A.02.00

Select Marker

Displays the menu keys that enable you to select, set up and control the markers for the current measurement

Key Path	Marker
Initial S/W Revision	Prior to A.02.00

Select Marker

Displays 12 markers available for selection.

Key Path	Marker, Properties
Initial S/W Revision	Prior to A.02.00

Relative To

Selects the desired marker. The selected marker will be relative to its reference marker.

Key Path	Marker, Properties
Mode	SA, WCDMA, C2K, WIMAX OFDMA, TD-SCDMA, 1xEVDO, ISDB-T, CMMB, LTE, LTETDD, BLUETOOTH, WLAN, MSR, LTEAFDD, LTEATDD
Remote Command	:CALCulate:OBWidth:MARKer[1] 2 ... 12:REFerence <integer> :CALCulate:OBWidth:MARKer[1] 2 ... 12:REFerence?
Example	CALC:OBW:MARK:REF 2

	CALC:OBW:MARK:REF?
Notes	A marker cannot be relative to itself so that choice is grayed out, and if sent from SCPI generates error -221: "Settings conflict; marker cannot be relative to itself." When queried a single value is returned (the specified marker numbers relative marker). You must be in the Spectrum Analysis mode, WCDMA mode, TD-SCDMA mode, 1xEVDO mode, WIMAX OFDMA mode ISDB-T mode, WLAN mode, CMMB mode, LTE mode, LTETDD mode or BLUETOOTH mode to use this command. Use:INSTrument:SElect to set the mode.
Preset	2 3 4 5 6 7 8 9 10 11 12 1
State Saved	Saved in instrument state.
Min	1
Max	12
Readback	Current selected relative to marker number.
Initial S/W Revision	Prior to A.02.00
Modified at S/W Revision	A.03.00

All Markers Off

Turns off all markers.

Key Path	Marker
Mode	SA, WCDMA, C2K, WIMAX OFDMA, TD-SCDMA, 1xEVDO, ISDB-T, CMMB, LTE, LTETDD, BLUETOOTH, WLAN, MSR, LTEAFDD, LTEATDD
Remote Command	:CALCulate:OBWidth:MARKer:AOff
Example	CALC:OBW:MARK:AOff
Initial S/W Revision	Prior to A.02.00
Modified at S/W Revision	A.03.00

Marker X Axis Value (Remote Command Only)

Sets the marker X Axis value in the current marker X Axis Scale unit. It has no effect if the control mode is Off.

Key Path	SCPI only
Mode	SA, WCDMA, C2K, WIMAX OFDMA, TD-SCDMA, 1xEVDO, ISDB-T, CMMB, LTE, LTETDD, BLUETOOTH, WLAN, MSR, LTEAFDD, LTEATDD
Remote Command	:CALCulate:OBWidth:MARKer[1] 2 ... 12:X <freq> :CALCulate:OBWidth:MARKer[1] 2 ... 12:X?
Example	CALC:OBW:MARK3:X 0 CALC:OBW:MARK3:X?
Notes	The query returns the marker's absolute X Axis value if the control mode is Normal, or the offset from

	the marker's reference marker if the control mode is Delta. The query is returned in the fundamental units for the current marker X Axis scale: Hz for Frequency.
Preset	After a preset, all markers are turned OFF, so Marker X Axis Value query returns a not a number (NAN).
State Saved	No
Min	-9.9E+37
Max	9.9E+37
Initial S/W Revision	Prior to A.02.00
Modified at S/W Revision	A.03.00

Marker X Axis Position (Remote Command Only)

Sets the marker X position in trace points. It has no effect if the control mode is Off.

Key Path	SCPI only
Mode	SA, WCDMA, C2K, WIMAX OFDMA, TD-SCDMA, 1xEVDO, ISDB-T, CMMB, LTE, LTETDD, BLUETOOTH, WLAN, MSR, LTEAFDD, LTEATDD
Remote Command	:CALCulate:OBWidth:MARKer[1] 2 ... 12:X:POSition <real> :CALCulate:OBWidth:MARKer[1] 2 ... 12:X:POSition?
Example	CALC:OBW:MARK10:X:POS 0 CALC:OBW:MARK10:X:POS?
Notes	The query returns the marker's absolute X Axis value in trace points if the control mode is Normal, or the offset from the marker's reference marker in trace points if the control mode is Delta.
Preset	After a preset, all markers are turned OFF, so Marker X Axis Value query returns a not a number (NAN).
State Saved	No
Min	-9.9E+37
Max	9.9E+37
Initial S/W Revision	Prior to A.02.00
Modified at S/W Revision	A.03.00

Marker Y Axis Value (Remote Command Only)

Returns the marker Y Axis value in the current marker Y Axis unit.

Key Path	SCPI only
Mode	SA, WCDMA, C2K, WIMAX OFDMA, TD-SCDMA, 1xEVDO, ISDB-T, CMMB, LTE, LTETDD, BLUETOOTH, WLAN, MSR, LTEAFDD, LTEATDD
Remote Command	:CALCulate:OBWidth:MARKer[1] 2 ... 12:Y?

Example	CALC:OBW:MARK11:Y?
Preset	Result dependent on Markers setup and signal source.
State Saved	No
Min	-9.9E+37
Max	9.9E+37
Initial S/W Revision	Prior to A.02.00
Modified at S/W Revision	A.03.00

Backward Compatibility SCPI Commands

Sets or queries the state of a marker. Setting a marker which is OFF to state ON or 1 puts it in Normal mode and places it at the center of the screen.

Key Path	SCPI only
Mode	SA, WCDMA, C2K, WIMAX OFDMA, TD-SCDMA, 1xEVDO, ISDB-T, CMMB, LTE, LTETDD, BLUETOOTH, WLAN, MSR, LTEAFDD, LTEATDD
Remote Command	:CALCulate:OBWidth:MARKer[1] 2 ... 12:STATe OFF ON 0 1 :CALCulate:OBWidth:MARKer[1] 2 ... 12:STATe?
Example	CALC:OBW:MARK3:STAT ON CALC:OBW:MARK3:STAT?
Preset	OFF
State Saved	Saved in instrument state.
Initial S/W Revision	Prior to A.02.00
Modified at S/W Revision	A.03.00

Marker Function

There are no 'Marker Functions' supported in this measurement. When pressed, this key displays a blank menu.

Key Path	Front panel key
Initial S/W Revision	Prior to A.02.00

Marker To

There is no 'Marker To' functionality supported in this measurement. When pressed, this key displays a blank menu.

Key Path	Front panel key
Initial S/W Revision	Prior to A.02.00

Meas

The information in this section is common to all measurements. For key and remote command information for a specific measurement, refer to the section that describes the measurement of interest.

Measurements available under the Meas key are specific to the current Mode.

When viewing Help for measurements, note the following:

NOTE

Operation for some keys differs between measurements. The information displayed in Help pertains to the current measurement. To see how a key operates in a different measurement, exit Help (press the Cancel Esc key), select the measurement, then reenter Help (press the Help key) and press that key.

Key Path	Front-panel key
Initial S/W Revision	Prior to A.02.00

Remote Measurement Functions

This section contains the following topics:

["Measurement Group of Commands" on page 2016](#)

["Current Measurement Query \(Remote Command Only\)" on page 2018](#)

["Limit Test Current Results \(Remote Command Only\)" on page 2018](#)

["Data Query \(Remote Command Only\)" on page 2018](#)

["Calculate/Compress Trace Data Query \(Remote Command Only\)" on page 2019](#)

["Calculate Peaks of Trace Data \(Remote Command Only\)" on page 2024](#)

["Hardware-Accelerated Fast Power Measurement \(Remote Command Only\)" on page 2025](#)

["Format Data: Numeric Data \(Remote Command Only\)" on page 2039](#)

["Format Data: Byte Order \(Remote Command Only\)" on page 2040](#)

Initial S/W Revision	Prior to A.02.00
----------------------	------------------

Measurement Group of Commands

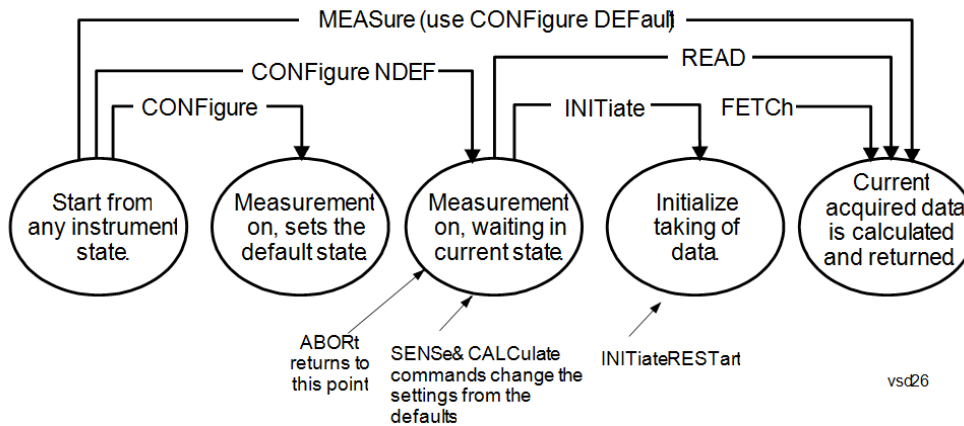

Measure Commands:

:MEASure:<measurement>[n]?

This is a fast single-command way to make a measurement using the factory default instrument settings. These are the settings and units that conform to the Mode Setup settings (e.g. radio standard) that you have currently selected.

- Stops the current measurement (if any) and sets up the instrument for the specified measurement using the factory defaults
- Initiates the data acquisition for the measurement
- Blocks other SCPI communication, waiting until the measurement is complete before returning results.
- If the function does averaging, it is turned on and the number of averages is set to 10.
- After the data is valid it returns the scalar results, or the trace data, for the specified measurement. The type of data returned may be defined by an [n] value that is sent with the command.
- The scalar measurement results will be returned if the optional [n] value is not included, or is set to 1. If the [n] value is set to a value other than 1, the selected trace data results will be returned. See each command for details of what types of scalar results or trace data results are available.
- ASCII is the default format for the data output. (Older versions of Spectrum Analysis and Phase Noise mode measurements only use ASCII.) The binary data formats should be used for handling large blocks of data since they are smaller and faster than the ASCII format. Refer to the FORMat:DATA command for more information.

If you need to change some of the measurement parameters from the factory default settings you can set up the measurement with the CONFIgure command. Use the commands in the SENSe:<measurement> and CALCulate:<measurement> subsystems to change the settings. Then you can use the READ? command to initiate the measurement and query the results.

If you need to repeatedly make a given measurement with settings other than the factory defaults, you can use the commands in the SENSe:<measurement> and CALCulate:<measurement> subsystems to set up the measurement. Then use the READ? command to initiate the measurement and query results.

Measurement settings persist if you initiate a different measurement and then return to a previous one. Use READ:<measurement>? if you want to use those persistent settings. If you want to go back to the default settings, use MEASure:<measurement>?.

Configure Commands:

:CONFIgure:<measurement>

This command stops the current measurement (if any) and sets up the instrument for the specified measurement using

the factory default instrument settings. It does not initiate the taking of measurement data unless INIT:CONTinuous is ON. If you change any measurement settings after using the CONFigure command, the READ command can be used to initiate a measurement without changing the settings back to their defaults.

In the Swept SA measurement in Spectrum Analyzer mode the CONFigure command also turns the averaging function on and sets the number of averages to 10 for all measurements.

:CONFigure: <measurement>: NDEFault stops the current measurement and changes to the specified measurement. It does not change the settings to the defaults. It does not initiate the taking of measurement data unless INIT:CONTinuous is ON.

The CONFigure? query returns the current measurement name.

The CONFigure:CATalog? query returns a quoted string of all licensed measurement names in the current mode. For example, "SAN, CHP, OBW, ACP, PST, TXP, SPUR, SEM, LIST".

Fetch Commands:

:FETCh:<measurement>[n]?

This command puts selected data from the most recent measurement into the output buffer. Use FETCh if you have already made a good measurement and you want to return several types of data (different [n] values, for example, both scalars and trace data) from a single measurement. FETCh saves you the time of re-making the measurement. You can only FETCh results from the measurement that is currently active, it will not change to a different measurement. An error message is reported if a measurement other than the current one is specified.

If you need to get new measurement data, use the READ command, which is equivalent to an INITiate followed by a FETCh.

The scalar measurement results will be returned if the optional [n] value is not included, or is set to 1. If the [n] value is set to a value other than 1, the selected trace data results will be returned. See each command for details of what types of scalar results or trace data results are available. The binary data formats should be used for handling large blocks of data since they are smaller and transfer faster than the ASCII format. (FORMat:DATA)

FETCh may be used to return results other than those specified with the original READ or MEASure command that you sent.

INITiate Commands:

:INITiate:<measurement>

This command is not available for measurements in all the instrument modes:

- Initiates a trigger cycle for the specified measurement, but does not output any data. You must then use the FETCh<meas> command to return data. If a measurement other than the current one is specified, the instrument will switch to that measurement and then initiate it.
 - For example, suppose you have previously initiated the ACP measurement, but now you are running the channel power measurement. If you send INIT:ACP? it will change from channel power to ACP and will initiate an ACP measurement.
 - Does not change any of the measurement settings. For example, if you have previously started the ACP measurement and you send INIT:ACP? it will initiate a new ACP measurement using the same instrument settings as the last time ACP was run.
 - If your selected measurement is currently active (in the idle state) it triggers the measurement, assuming the trigger conditions are met. Then it completes one trigger cycle. Depending upon the measurement and the number of averages, there may be multiple data acquisitions, with multiple trigger events, for one full trigger cycle. It also holds off additional commands on GPIB until the acquisition is complete.
-

READ Commands:

:READ:<measurement>[n]?

- Does not preset the measurement to the factory default settings. For example, if you have previously initiated the ACP
-

measurement and you send READ:ACP? it will initiate a new measurement using the same instrument settings.

- Initiates the measurement and puts valid data into the output buffer. If a measurement other than the current one is specified, the instrument will switch to that measurement before it initiates the measurement and returns results.
 - For example, suppose you have previously initiated the ACP measurement, but now you are running the channel power measurement. Then you send READ:ACP? It will change from channel power back to ACP and, using the previous ACP settings, will initiate the measurement and return results.
 - Blocks other SCPI communication, waiting until the measurement is complete before returning the results
 - If the optional [n] value is not included, or is set to 1, the scalar measurement results will be returned. If the [n] value is set to a value other than 1, the selected trace data results will be returned. See each command for details of what types of scalar results or trace data results are available. The binary data formats should be used when handling large blocks of data since they are smaller and faster than the ASCII format. (FORMat:DATA)
-

Initial S/W Revision	Prior to A.02.00
----------------------	------------------

Current Measurement Query (Remote Command Only)

This command returns the name of the measurement that is currently running.

Remote Command	:CONFigure?
-----------------------	-------------

Example	CONF?
----------------	-------

Initial S/W Revision	Prior to A.02.00
----------------------	------------------

Limit Test Current Results (Remote Command Only)

Queries the status of the current measurement limit testing. It returns a 0 if the measured results pass when compared with the current limits. It returns a 1 if the measured results fail any limit tests.

Remote Command	:CALCulate:CLIMits:FAIL?
-----------------------	--------------------------

Example	CALC:CLIM:FAIL? queries the current measurement to see if it fails the defined limits. Returns a 0 or 1: 0 it passes, 1 it fails.
----------------	--

Initial S/W Revision	Prior to A.02.00
----------------------	------------------

Data Query (Remote Command Only)

Returns the designated measurement data for the currently selected measurement and subopcode.

n = any valid subopcode for the current measurement. See the measurement command results table for your current measurement, for information about what data is returned for the subopcodes.

This command uses the data setting specified by the FORMat:BORDER and FORMat:DATA commands and can return real or ASCII data. (See the format command descriptions under Input/Output in the Analyzer Setup section.)

Remote Command	:CALCulate:DATA[n]?
Notes	The return trace depends on the measurement. In CALCulate:<meas>:DATA[n], n is any valid subopcode for the current measurement. It returns the same data as the FETCH:<measurement>? query where <measurement> is the current measurement.
Initial S/W Revision	Prior to A.02.00

Calculate/Compress Trace Data Query (Remote Command Only)

Returns compressed data for the currently selected measurement and sub-opcode [n].

n = any valid sub-opcode for that measurement. See the MEASure:<measurement>? command description of your specific measurement for information on the data that can be returned.

The data is returned in the current Y Axis Unit of the analyzer. The command is used with a sub-opcode <n> (default=1) to specify the trace. With trace queries, it is best if the analyzer is not sweeping during the query. Therefore, it is generally advisable to be in Single Sweep, or Update=Off.

This command is used to compress or decimate a long trace to extract and return only the desired data. A typical example would be to acquire N frames of GSM data and return the mean power of the first burst in each frame. The command can also be used to identify the best curve fit for the data.

Remote Command	:CALCulate:DATA<n>:COMPRESS? BLOCK CFIT MAXimum MINimum MEAN DMEan RMS RMSCubed SAMPLE SDEVIation PPHase [,<soffset> [,<length>[,<roffset>[,<rlimit>]]]]
Example	To query the mean power of a set of GSM bursts: Supply a signal that is a set of GSM bursts. Select the IQ Waveform measurement (in IQ Analyzer Mode). Set the sweep time to acquire at least one burst. Set the triggers such that acquisition happens at a known position relative to a burst. Then query the mean burst levels using, CALC:DATA2:COMP? MEAN, 24e-6, 526e-6 (These parameter values correspond to GSM signals, where 526e-6 is the length of the burst in the slot and you just want 1 burst.)
Notes	The command supports 5 parameters. Note that the last 4 (<soffset>, <length>, <roffset>, <rlimit>) are optional. But these optional parameters must be entered in the specified order. For example, if you want to specify <length>, then you must also specify <soffset>. See details below for a definition of each of these parameters. This command uses the data in the format specified by FORMat:DATA, returning either binary or ASCII data.
Initial S/W Revision	Prior to A.02.00

- BLOCK or block data - returns all the data points from the region of the trace data that you specify. For example, it could be used to return the data points of an input signal over several timeslots, excluding the portions of the trace data that you do not want. (This is x,y pairs for trace data and I,Q pairs for complex data.)

- CFIT or curve fit - applies curve fitting routines to the data. <soffset> and <length> are required to define the data that you want. <roffset> is an optional parameter for the desired order of the curve equation. The query will return the following values: the x-offset (in seconds) and the curve coefficients ((order + 1) values).

MIN, MAX, MEAN, DME, RMS, RMSC, SAMP, SDEV and PPH return one data value for each specified region (or <length>) of trace data, for as many regions as possible until you run out of trace data (using <roffset> to specify regions). Or they return the number of regions you specify (using <rlimit>) ignoring any data beyond that.

- MINimum - returns the minimum data point (y value) for the specified region(s) of trace data. For I/Q trace data, the minimum magnitude of the I/Q pairs is returned.
- MAXimum - returns the maximum data point (y value) for the specified region(s) of trace data. For I/Q trace data, the maximum magnitude of the I/Q pairs is returned.
- MEAN - returns a single value that is the arithmetic mean of the data point values (in dB/ dBm) for the specified region(s) of trace data. For I/Q trace data, the mean of the magnitudes of the I/Q pairs is returned. See the following equations.

-

NOTE

If the original trace data is in dB, this function returns the arithmetic mean of those log values, not log of the mean power which is a more useful value. The mean of the log is the better measurement technique when measuring CW signals in the presence of noise. The mean of the power, expressed in dB, is useful in power measurements such as Channel Power. To achieve the mean of the power, use the RMS option.

Equation 1

Mean Value of Data Points for Specified Region(s)

$$\text{MEAN} = \frac{1}{n} \sum_{X_i \in \text{region}(s)} X_i$$

where X_i is a data point value, and n is the number of data points in the specified region(s).

Equation 2

Mean Value of I/Q Data Pairs for Specified Region(s)

$$\text{MEAN} = \frac{1}{n} \sum_{X_i \in \text{region}(s)} |X_i|$$

where $|X_i|$ is the magnitude of an I/Q pair, and n is the number of I/Q pairs in the specified region(s).

- DMEan - returns a single value that is the mean power (in dB/ dBm) of the data point values for the specified region(s) of trace data. See the following equation:

Equation 3

DMEan Value of Data Points for Specified Region(s)

$$\text{DME} = 10 \times \log_{10} \left(\frac{1}{n} \sum_{X_i \in \text{region}(s)} 10^{\frac{X_i}{10}} \right)$$

- RMS - returns a single value that is the average power on a root-mean-squared voltage scale (arithmetic rms) of the data point values for the specified region(s) of trace data. See the following equation.

NOTE For I/Q trace data, the rms of the magnitudes of the I/Q pairs is returned. See the following equation. This function is very useful for I/Q trace data. However, if the original trace data is in dB, this function returns the rms of the log values which is not usually needed.

Equation 4

RMS Value of Data Points for Specified Region(s)

$$\text{RMS} = \sqrt{\frac{1}{n} \sum_{X_i \in \text{region}(s)} X_i^2}$$

where X_i is a data point value, and n is the number of data points in the specified region(s).

Equation 5

RMS Value of I/Q Data Pairs for Specified Region(s)

$$\text{RMS} = \sqrt{\frac{1}{n} \sum_{X_i \in \text{region}(s)} X_i X_i^*}$$

where X_i is the complex value representation of an I/Q pair, X_i^* its conjugate complex number, and n is the number of I/Q pairs in the specified region(s).

Once you have the rms value for a region of trace data (linear or I/Q), you may want to calculate the mean power. You must convert this rms value (peak volts) to power in dBm:

$$10 \times \log[10 \times (\text{rms value})^2]$$

- SAMPlE - returns the first data value (x,y pair) for the specified region(s) of trace data. For I/Q trace data, the first I/Q pair is returned.
- SDEViation - returns a single value that is the arithmetic standard deviation for the data point values for the specified region(s) of trace data. See the following equation.
- For I/Q trace data, the standard deviation of the magnitudes of the I/Q pairs is returned. See the following equation.

Equation 6

Standard Deviation of Data Point Values for Specified Region(s)

$$\text{SDEV} = \sqrt{\frac{1}{n} \sum_{X_i \in \text{region}(s)} (X_i - \bar{X})^2}$$

where X_i is a data point value, \bar{X} is the arithmetic mean of the data point values for the specified region (s), and n is the number of data points in the specified region(s).

$$\text{SDEV} = \sqrt{\frac{1}{n} \sum_{X_i \in \text{region}(s)} (|X_i| - \bar{X})^2}$$

where $|X_i|$ is the magnitude of an I/Q pair, \bar{X} is the mean of the magnitudes for the specified region(s), and n is the number of data points in the specified region(s).

- PPHase - returns the x,y pairs of both rms power (dBm) and arithmetic mean phase (radian) for every specified region and frequency offset (Hz). The number of pairs is defined by the specified number of regions. This parameter can be used for I/Q vector (n=0) in Waveform (time domain) measurement and all parameters are specified by data point in PPHase.

The rms power of the specified region may be expressed as:

$$\text{Power} = 10 \times \log [10 \times (\text{RMS I/Q value})] + 10.$$

The RMS I/Q value (peak volts) is:

$$\sqrt{\frac{1}{n} \sum_{X_i \in \text{region}} X_i X_i^*}$$

where X_i is the complex value representation of an I/Q pair, X_i^* its conjugate complex number, and n is the number of I/Q pairs in the specified region.

The arithmetic mean phase of the specified region may be expressed as:

$$\frac{1}{n} \sum_{Y_i \in \text{region}} Y_i$$

where Y_i is the unwrapped phase of I/Q pair with applying frequency correction and n is the number of I/Q pairs in the specified region.

The frequency correction is made by the frequency offset calculated by the arithmetic mean of every specified region's frequency offset. Each frequency offset is calculated by the least square method against the unwrapped phase of I/Q pair.

Sample Trace Data - Constant Envelope

(See below for explanation of variables.)

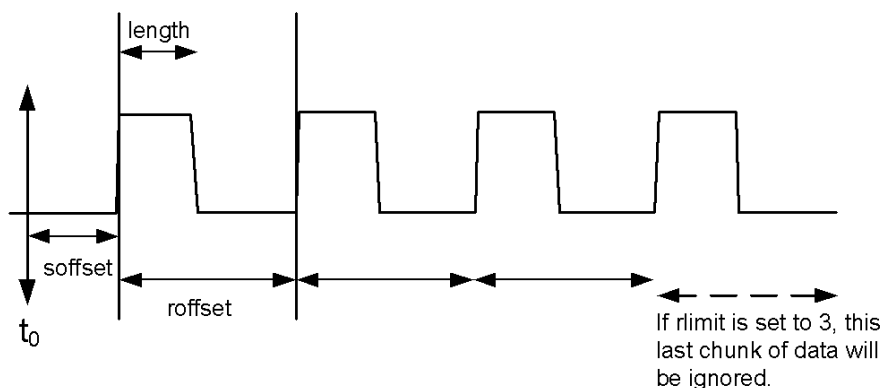

Sample Trace Data - Not Constant Envelope

(See below for explanation of variables.)

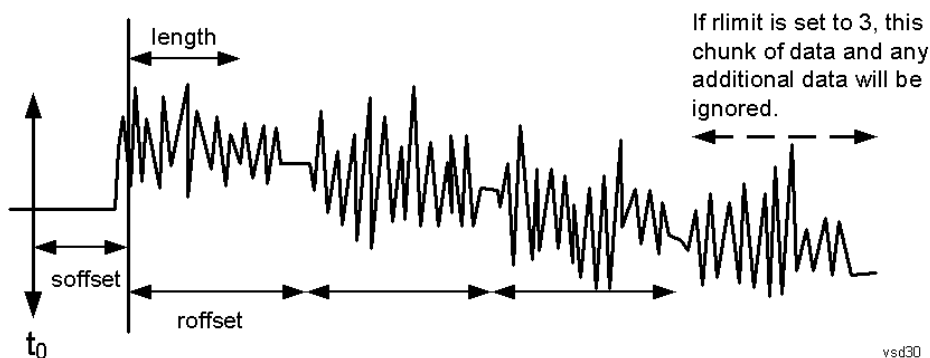

<soffset> - start offset is an optional real number. (It is in seconds for time-domain traces, and is a dimensionless index 0 to Npoints - 1, for frequency-domain traces). It specifies the amount of data at the beginning of the trace that will be ignored before the decimation process starts. It is the time or frequency change from the start of the trace to the point where you want to start using the data. The default value is zero.

<length> - is an optional real number. (It is in seconds for time-domain traces, and is a dimensionless index 0 to Npoints - 1, for frequency-domain traces). It defines how much data will be compressed into one value. This parameter has a default value equal to the current trace length.

<roffset> - repeat offset is an optional real number. (It is in seconds for time-domain traces, and is a dimensionless index 0 to Npoints - 1, for frequency-domain traces). It defines the beginning of the next field of trace elements to be compressed. This is relative to the beginning of the previous field. This parameter has a default value equal to the <length> variable. Note that this parameter is used for a completely different purpose when curve fitting (see CFIT above).

<rlimit> - repeat limit is an optional integer. It specifies the number of data items that you want returned. It will ignore any additional items beyond that number. You can use the Start offset and the Repeat limit to pick out exactly what part of the data you want to use. The default value is all the data.

Calculate Peaks of Trace Data (Remote Command Only)

Returns a list of all the peaks for the currently selected measurement and sub-opcode [n]. The peaks must meet the requirements of the peak threshold and excursion values.

n = any valid sub-opcode for the current measurement. See the MEASure:<measurement> command description of your specific measurement for information on the data that can be returned.

The command can only be used with specific sub-opcodes with measurement results that are trace data. Both real and complex traces can be searched, but complex traces are converted to magnitude in dBm. In many measurements the sub-opcode n=0, is the raw trace data which cannot be searched for peaks. And Sub-opcode n=1, is often calculated results values which also cannot be searched for peaks.

This command uses the data setting specified by the FORMat:BORDER and FORMat:DATA commands and can return real or ASCII data. If the format is set to INT,32, it returns REAL,32 data.

The command has four types of parameters:

- Threshold (in dBm)
- Excursion (in dB)
- Sorting order (amplitude, frequency, time)
- Optional in some measurements: Display line use (all, > display line, < display line)

Remote Command	<p>For Swept SA measurement:</p> <pre>:CALCulate:DATA[1] 2 ... 6:PEAKs? <threshold>,<excursion>[,AMPLitude FREQuency TIME[,ALL GTDLline LTDLine]]</pre> <p>For most other measurements:</p> <pre>:CALCulate:DATA[1] 2 ... 6:PEAKs? <threshold>,<excursion>[,AMPLitude FREQuency TIME]</pre>
Example	<p>Example for Swept SA measurement in Spectrum Analyzer Mode:</p> <p>CALC:DATA4:PEAK? -40, 10, FREQ, GTDL This will identify the peaks of trace 4 that are above -40 dBm, with excursions of at least 10 dB. The peaks are returned in order of increasing frequency, starting with the lowest frequency. Only the peaks that are above the display line are returned.</p> <p>Query Results 1:</p> <p>With FORMat:DATA REAL, 32 selected, it returns a list of floating-point numbers. The first value in the list is the number of peak points that are in the following list. A peak point consists of two values: a peak amplitude followed by its corresponding frequency (or time).</p> <p>If no peaks are found the peak list will consist of only the number of peaks, (0).</p>
Notes	<p><n> - is the trace that will be used</p> <p><threshold> - is the level below which trace data peaks are ignored. Note that the threshold value is required and is always used as a peak criterion. To effectively disable the threshold criterion for this command, provide a substantially low threshold value such as -200 dBm. Also note that the threshold value used in this command is independent of and has no effect on the threshold value stored under the Peak Criteria menu.</p> <p><excursion> - is the minimum amplitude variation (rise and fall) required for a signal to be identified as peak. Note that the excursion value is required and is always used as a peak criterion. To effectively disable the excursion criterion for this command, provide the minimum value of 0.0 dB. Also note that the excursion value used in this command is independent of and has no effect on the</p>

excursion value stored under the Peak Criteria menu.

Values must be provided for threshold and excursion. The sorting and display line parameters are optional (defaults are AMPLitude and ALL).

Note that there is always a Y-axis value for the display line, regardless of whether the display line state is on or off. It is the current Y-axis value of the display line which is used by this command to determine whether a peak should be reported. Sorting order:

AMPLitude - lists the peaks in order of descending amplitude, with the highest peak first (default if optional parameter not sent)

FREQuency - lists the peaks in order of occurrence, left to right across the x-axis.

TIME - lists the peaks in order of occurrence, left to right across the x-axis.

Peaks vs. Display Line:

ALL - lists all of the peaks found (default if optional parameter not sent).

GTDLine (greater than display line) - lists all of the peaks found above the display line.

LTDLine (less than display line) - lists all of the peaks found below the display line.

Initial S/W Revision	Prior to A.02.00
----------------------	------------------

Hardware-Accelerated Fast Power Measurement (Remote Command Only)

The Fast Power option (FP2) enables very fast channel power measurements for instruments with the prerequisite hardware (DP2 and/or B40). It accomplishes this by performing real-time overlapped FFTs at the hardware layer, using software for basic post-processing before returning the result to the user. The upshot of this approach is improved throughput for user applications that require many sequential power measurements.

The analysis bandwidth of FP2 is limited by the licenses in the instrument, but its maximum overall analysis bandwidth per acquisition is 40 MHz.

FP2 is remote-only, which means the instrument does not switch to any particular mode or measurement. FP2 commands can be sent while another application is in use on the front panel.

Each Fast Power measurement can be predefined using an array index, and up to 1,000 measurements can be stored. In the following documentation, instances of [1,2,...,999] can be substituted with a particular measurement index, e.g. CALC:FPOW:POW1?, CALC:FPOW:POW2?, CALC:FPOW:POW134?. In this way, power measurements can be defined one time in a batch, and then executed multiple times without having to redefine them, similar to “list mode” on other measurements.

In addition to basic channel power measurements, there are a number of other measurement “functions” for each channel, including peak power, peak frequency, and power spectral density. See the Function parameter for more information.

Reset Fast Power Measurement (Remote Command Only)

Resets the measurement configuration to the defaults.

Mode	All
Remote Command	:CALCulate:FPOWer:POWer [1, 2, ..., 999] :RESet
Example	:CALC:FPOW:POW1:RES

Notes	Option FP2 is required.
Initial S/W Revision	A.14.00

Define Fast Power Measurement (Remote Command Only)

Fast Power acquisitions are configured using the DEFine command. This command accepts a comma-delimited string of configuration parameters and their appropriate values, which are all specified in the subsection below.

Mode	All
Remote Command	:CALCulate:FPOWer:POWer[1,2,...,999]:DEFine "configuration string"
Example	:CALC:FPOW:POW1:DEF "CenterFrequency=2e9, AcquisitionTime=0.005"
Notes	See below for a list of measurement variables that can be defined in the configuration string.
Initial S/W Revision	A.14.00

Acquisition Time

Example	CALC:FPOW:POW1:DEF "AcquisitionTime=0.002"
Notes	The acquisition time parameter sets the time in which the entire spectrum is measured. An increase in the acquisition time yields an improvement in measurement repeatability.
Preset	0.001 s
Range	0 s to 1 s
Default Unit	Time (s)
Initial S/W Revision	A.14.00

Center Frequency

Example	CALC:FPOW:POW1:DEF "CenterFrequency=2e9"
Notes	The center frequency parameter sets the frequency in which the measurement is centered around. The OffsetFrequency parameter is calculated relative to the center frequency.
Preset	1 GHz
Range	0 Hz to maximum instrument frequency
Default Unit	Frequency (Hz)
Initial S/W Revision	A.14.00

DC Coupled

Example	CALC:FPOW:POW1:DEF "DCCoupled=True"
Notes	The DC coupled parameter allows the user to specify whether the DC blocking capacitor is utilized. Set parameter to true when measuring frequencies below 10 MHz.
Preset	False
Range	True (DC Coupled) or False (AC Coupled)
Default Unit	Boolean
Initial S/W Revision	A.14.00

DetectorType

Example	CALC:FPOW:POW1:DEF "DetectorType=Peak"
Notes	Option FP2 is required. The detector type parameter allows the user to choose whether a RMS average or peak value is used during the measurement.
Preset	RmsAverage
Range	RmsAverage, Peak
Initial S/W Revision	A.14.00

Do Noise Correction

Example	CALC:FPOW:POW1:DEF "DoNoiseCorrection=True"
Notes	When noise correction is enabled, the linear noise power contributed by the analyzer is subtracted from all measurements. This effectively lowers the noise floor of the analyzer. When noise correction is enabled, the first measurement for a given set of input parameters will take extra time. This is because the analyzer takes an extra acquisition with the RF input disconnected from the analyzer's front end to measure the noise of just the analyzer. The measured noise floor is stored in a cache so the noise acquisition will occur only once for the same state settings. In other words, if noise correction was turned on and the analyzer made an acquisition at frequency A, then frequency B, and back again to frequency A, the hidden initial noise floor acquisition would only occur for the first acquisition at frequency A and the cached noise floor would be used the second time frequency A was measured.
Preset	False
Range	True (enable noise correction) or False (disable noise correction)
Default Unit	Boolean
Initial S/W Revision	A.14.00

Do Spur Suppression

Example	CALC:FPOW:POW1:DEF "DoSpurSuppression=True"
Notes	<p>When measuring very low level signals, or when large out-of-band inputs are input into the analyzer, sometimes unwanted spurs and residuals can appear in the measured spectrum. Spur suppression is a method to help minimize the levels of these internally generated spurs and residuals.</p> <p>When spur suppression is enabled, the analyzer will automatically take two acquisitions using two different internal analog LO frequencies. The FFT spectrums from both acquisitions are combined by taking the minimum power between both traces on a per FFT bin basis. External signals will have the same amplitude for both traces and therefore will return the expected amplitudes. However, low level spurs and residuals generated internally to the analyzer tend to move to different FFT bins depending on the internal analog LO frequency used, and therefore tend to be suppressed using this spur suppression method.</p> <p>Because two acquisitions, rather than a single acquisition, are made when spur suppression is enabled, the measurement time will always be slower when spur suppression is enabled.</p>
Preset	False
Range	True (enable spur suppression) or False (disable spur suppression)
Default Unit	Boolean
Initial S/W Revision	A.14.00

Electronic Attenuator Bypass

Example	CALC:FPOW:POW1:DEF "ElecAttBypass =False"
Notes	The electronic attenuation bypass parameter allows the user to either utilize or bypass the electronic attenuator. The electronic attenuator is only available for frequencies up to 3.6 GHz. Set parameter to true when using frequencies above 3.6 GHz and set the parameter to false when using the preamp.
Preset	True
Range	True (bypass electronic attenuator) or False (use electronic attenuator)
Default Unit	Boolean
Initial S/W Revision	A.14.00

Electronic Attenuation

Example	CALC:FPOW:POW1:DEF "ElecAttenuation=10"
Notes	<p>Option EA3 is required.</p> <p>The electronic attenuation value parameter sets the amount of electrical attenuation from 0 to 24 dB (1 dB steps).</p> <p>Set "ElecAttBypass=False" to make sure the electronic attenuator path is enabled.</p>
Preset	0 dB
Range	0 - 24 dB (1 dB steps)

Default Unit	dB
Initial S/W Revision	A.14.00

IF Gain

Example	CALC:FPOW:POW1:DEF "IFGain=10"
Notes	The IF gain parameter allows the user to specify the gain at the IF stage anywhere from -6 to 16 dB (1 dB steps). This is an advanced feature, and for most cases this should remain at its default value of 0 dB.
Preset	0 dB
Range	-6 - 16 dB (1 dB steps)
Default Unit	dB
Initial S/W Revision	A.14.00

IF Type

Example	CALC:FPOW:POW1:DEF "IFType=B25M"
Notes	The IF type parameter allows the user to select between different IF paths. For example, if the signal is less than 25 MHz wide, then the user can select the B25M path to take advantage of additional filtering on this analog IF path.
Preset	B40M
Range	B10M, B25M, B40M
Initial S/W Revision	A.14.00

Include Power Spectrum

Example	CALC:FPOW:POW1:DEF "IncludePowerSpectrum=True"
Notes	The power spectrum parameter allows the user to read data on the entire spectrum for diagnostic purposes. It is not recommended for production use. See CALC:FPOW:POW[n]:READ2? for details on the binary format of the response.
Preset	False
Range	True (return both channel power and full power spectrum) or False (returns only channel power)
Default Unit	Boolean
Initial S/W Revision	A.14.00

Mechanical Attenuation

Example	CALC:FPOW:POW1:DEF "MechAttenuation=10"
Notes	The mechanical attenuation value parameter sets the amount of mechanical attenuation anywhere from 0 to 70 dB (2 dB steps).
Preset	0 dB
Range	0 – 70 dB (2 dB steps)
Default Unit	dB
Initial S/W Revision	A.14.00

Preamp Mode

Example	CALC:FPOW:POW1:DEF "PreAmpMode=Low"
Notes	The license for the appropriate preamp is required. The preamp mode parameter specifies whether the preamps are being utilized. Low allows any preamps up to 3.6 GHz, and Full allows all licensed preamps. Set "ElecAttBypass=True" in order to utilize any preamps.
Preset	Off
Range	Off, Low, Full
Initial S/W Revision	A.14.00

Resolution Bandwidth Mode

Example	CALC:FPOW:POW1:DEF "PreAmpMode=Low"
Notes	The resolution bandwidth mode parameter allows the user to choose whether the RBW filter is automatically or manually set. The BestSpeed value minimizes measurement time, while the Narrowest value minimizes RBW size (minimum of two FFT bins per RBW). To manually specify an RBW, set this parameter to Explicit, and set the ResolutionBW parameter to the desired value.
Preset	BestSpeed
Range	BestSpeed, Narrowest, Explicit
Initial S/W Revision	A.14.00

Resolution Bandwidth

Example	CALC:FPOW:POW1:DEF "ResolutionBW=25e3"
Notes	The resolution bandwidth parameter sets the 3-dB bandwidth of the RBW filter. The ResolutionBWMode parameter must be set to Explicit in order to manually set the RBW.

Preset	0 Hz
Default Unit	Hz
Initial S/W Revision	A.14.00

Trigger Delay

Example	CALC:FPOW:POW1:DEF "TriggerDelay=0.025"
Notes	The trigger delay parameter sets the time after an external trigger is detected until the measurement is performed.
Preset	0 s
Range	0 – 1 s
Default Unit	Seconds
Initial S/W Revision	A.14.00

Trigger Level

Example	CALC:FPOW:POW1:DEF "TriggerLevel=2"
Notes	The trigger level parameter sets the voltage value at which an external trigger is detected.
Preset	1.2 V
Range	-5 to 5 V
Default Unit	Volts
Initial S/W Revision	A.14.00

Trigger Slope

Example	CALC:FPOW:POW1:DEF "TriggerSlope=Negative"
Notes	The trigger slope parameter indicates the direction of the edge trigger voltage for detection.
Preset	Positive
Range	Positive, Negative
Initial S/W Revision	A.14.00

Trigger Source

Example	CALC:FPOW:POW1:DEF "TriggerSource=Ext1"
Notes	The trigger source parameter allows the user to choose between measurement's triggering freely or controlled by an external input. Ext1 and Ext2 correspond to Trigger 1 In and Trigger 2 In, respectively.
Preset	Free
Range	Free, Ext1, Ext2
Initial S/W Revision	A.14.00

Trigger Timeout

Example	CALC:FPOW:POW1:DEF "TriggerTimeout=0.1"
Notes	The trigger timeout parameter sets the time in which the analyzer will wait for a trigger before automatically performing the measurement.
Preset	1 s
Range	0 – 1 s
Default Unit	Seconds
Initial S/W Revision	A.14.00

Signal Input

Example	CALC:FPOW:POW1:DEF "SignalInput=Fp50MHzCW"
Notes	The signal input parameter allows the user to select between using the main RF input or the internal analyzer reference CW signal of 50 MHz.
Preset	FpMainRf
Range	FpMainRf, Fp50MHzCW
Initial S/W Revision	A.14.00

Use Preselector

Example	CALC:FPOW:POW1:DEF "UsePreSelector=True"
Notes	The preselector parameter allows the user to either utilize or bypass the front end tunable filter at frequencies above 3.6 GHz. For frequencies below 3.6 GHz, the preselector is automatically bypassed, so you do not need to set this parameter to False in those cases.
Preset	False
Range	True (use preselector above 3.6 GHz), or False (preselector bypassed)

Default Unit	Boolean
Initial S/W Revision	A.14.00

Channel Bandwidth Array

Example	CALC:FPOW:POW1:DEF "Bandwidth=[3.84e6, 5e6, 3.84e6]"
Notes	The bandwidth parameter array defines the bandwidth of each channel that will be measured. All array parameters should have the same number of elements. Alternatively, if all the elements are the same value, a single number with no square brackets can be used to define the parameter.
Preset	[1e6]
Range	0 to 40 MHz
Default Unit	Hz
Initial S/W Revision	A.14.00

Channel Filter Type Array

Example	CALC:FPOW:POW1:DEF "FilterType=[RRC, IBW, RRC]"
Notes	The filter type parameter allows the user to choose between an integration bandwidth (IBW) filter or a root-raised-cosine (RRC) filter. The integration bandwidth filter weighs all frequencies within the bandwidth equally. The root-raised-cosine filter has an associated shape parameter, defined by the FilterAlpha parameter. All array parameters should have the same number of elements. Alternatively, if all the elements are the same value, a single value with no square brackets can be used to define the parameter.
Preset	[IBW]
Range	IBW, RRC
Initial S/W Revision	A.14.00

Channel Filter Alpha Array

Example	CALC:FPOW:POW1:DEF "FilterAlpha=[0.5, 0.0, 0.5]"
Notes	The filter alpha parameter allows the user to adjust the alpha value associated with the root-raised-cosine (RRC) filter type. Set FilterType to RRC in order to utilize this parameter. All array parameters should have the same number of elements. Alternatively, if all the elements are the same value, a single number with no square brackets can be used to define the parameter.
Preset	[0.22]
Range	0.0 - 1.0

Initial S/W Revision	A.14.00
-------------------------	---------

Channel Measurement Function Array

Example	CALC:FPOW:POW1:DEF "Function=[BandPower, PeakPower, BandPower]"
Notes	<p>This parameter array defines what measurement is being made for each individually-specified channel:</p> <p>BandPower: Total power within the specified bandwidth of the channel (dBm)</p> <p>BandDensity: Total power density within the specified bandwidth of the channel (dBm/Hz)</p> <p>PeakPower: The peak power value within the specified bandwidth of the channel (dBm)</p> <p>PeakFrequency: The frequency which corresponds to the peak power value within the specified bandwidth of the channel. This frequency is relative to the center frequency (Hz)</p> <p>XdBBandwidth: The half power (-3.01 dB) bandwidth of the highest amplitude signal that resides within the channel (Hz), dB is configurable using XdBBandwidth parameter</p> <p>OccupiedBandwidth: The bandwidth at which 99% of the total power resides within the channel (Hz), percentage configurable using OccupiedBandwidthPercent parameter</p> <p>All array parameters should have the same number of elements. Alternatively, if all the elements are the same value, a single value with no square brackets can be used to define the parameter.</p>
Preset	[BandPower]
Range	BandPower, BandDensity, PeakPower, PeakFrequency, XdBBandwidth, OccupiedBandwidth
Initial S/W Revision	A.14.00

Channel Offset Frequency Array

Example	CALC:FPOW:POW1:DEF "OffsetFrequency=[-5e6, 0, 5e6]"
Notes	<p>The offset frequency parameter array defines the difference between the center frequency to the center frequency of each channel.</p> <p>All array parameters should have the same number of elements.</p>
Preset	[0]
Range	0 to 20 MHz
Default Unit	Hz
Initial S/W Revision	A.14.00

Channel Occupied Bandwidth Percent Array

Example	CALC:FPOW:POW1:DEF "OccupiedBandwidthPercent =[0.95, 0.95, 0.95]"
Notes	This parameter only applies for channels whose Function is set to OccupiedBandwidth. The occupied

	bandwidth percent parameter specifies the percent of total power in these channels. The valid range for this parameter is 0.0 to 1.0, where 1.0 represents 100%. The default for this parameter is 0.99, which will return the bandwidth that contains 99% of the total channel power.
Preset	[0.99]
Range	0 - 1.0
Initial S/W Revision	A.14.00

Channel x-dB Bandwidth Array

Example	CALC:FPOW:POW1:DEF " XdBBandwidth =[-6.02, -3.01, -1.0]"
Notes	This parameter only applies for channels whose Function is set to XdBBandwidth. The X dB bandwidth parameter is used to specify the power relative to the peak channel power over which the bandwidth is calculated. The parameter value must be a negative number.
Preset	[-3.01]
Range	-200 to 0 dB
Default Unit	dB
Initial S/W Revision	A.14.00

Define Fast Power Measurement Query (Remote Command Only)

The DEFine? command is used to retrieve a list of all defined parameters in an ASCII string format

M All
o
d
e

R :CALCulate:FPOWer:POWer[1,2,...,999]:DEFine?

e
m
o
t
e

C
o
m
m
a
n
d

E :CALC:FPOW:POW1:DEF?

x
a
m
p
l
e

N This command query is used to retrieve a list of all defined parameters in an ASCII format.

O The following is an example of the returned results:

S "DCCoupled=False,ElecAttBypass=True,ElecAttenuation=0,IFGain=0,MechAttenuation=0,PreAmpMode=Off,PreSelectorOffset=0,UsePreSelector=False,ExternalReferenceFrequency=1000000,FrequencyReferenceSource=AutoExternalFrequencyReference,IFType=B40M,LOMode=SLW,SignalInput=FpMainRf,AcquisitionTime=0.001,CenterFrequency=100000000,ResolutionBW=0,ResolutionBWMode=BestSpeed,DetectorType=RmsAverage,Bandwidth=[1000000],OffsetFrequency=[0],Function=[BandPower],FilterType=[IBW],FilterAlpha=[0.22],OccupiedBandwidthPercent=[0.99],XdBBandwidth=[-3.01],DoNoiseCorrection=False,DoSpurSuppression=False,MeasurementMethod=HardwareFFT,IncludePowerSpectrum=False,TriggerDelay=0,TriggerLevel=1.2,TriggerSlope=Positive,TriggerSource=Free,TriggerTimeout=1"

I A.14.00

n
i
t
i
a
l

S
/
W

R
e
v
i
s
i
o
n

Configure Fast Power Measurement (Remote Command Only)

The configure command begins hardware setup and returns immediately, with no acquisition made. This can be used in parallel with other hardware operations to effectively hide the hardware setup time.

Mode	All
Remote Command	:CALCulate:FPOWER:POWER[1,2,...,999]:CONFigure
Example	:CALC:FPOW:POW1:CONF
Notes	Option FP2 is required.
Initial S/W Revision	A.14.00

Initiate Fast Power Measurement (Remote Command Only)

The INITiate command begins an acquisition and returns immediately. The results of the measurement can be retrieved using FETCh.

Mode	All
Remote Command	:CALCulate:FPOWER:POWER[1,2,...,999]:INITiate
Example	:CALC:FPOW:POW1:INIT
Notes	Option FP2 is required.
Initial S/W Revision	A.14.00

Fetch Fast Power Measurement (Remote Command Only)

The FETCh command query is used to retrieve the results of an acquisition initiated by the INIT command. The returned results are in ASCII string format. The string begins and ends with quotation marks.

Mode	All
Remote Command	:CALCulate:FPOWER:POWER[1,2,...,999]:FETCh?
Example	:CALC:FPOW:POW1:FETC?
Notes	Option FP2 is required. Returns m comma-separated ASCII values, where m corresponds to the number of bandwidths defined. 1. Declared function return in the 1st specified channel 2. Declared function return in the 2nd specified channel ... m. Declared function return in the last specified channel The INIT and FETC? command sequence performs the same functionality of a single CALC:FPOW:POW[n]? query. Units of the returned values are dependent on the Function parameter for each channel.
Initial S/W Revision	A.14.00

Execute Fast Power Measurement (Remote Command Only)

This command query is used as shorthand for an INIT command immediately followed by a FETC? command. The returned results are in ASCII string format. The string begins and ends with quotation marks.

Mode	All
Remote Command	:CALCulate:FPOWER:POWER[1,2,...,999]?
Example	:CALC:FPOW:POW1?

Notes	Option FP2 is required. See notes for Fast Power Fetch for return format.
Initial S/W Revision	A.14.00

Binary Read Fast Power Measurement (Remote Command Only)

This command query is used as shorthand for an INIT command immediately followed by a FETC? command. The returned results are in a binary format.

Mode	All
Remote Command	:CALCulate:FPOWER:POWER[1,2,...,999]:READ? :CALCulate:FPOWER:POWER[1,2,...,999]:READ1?
Example	:CALC:FPOW:POW1:READ? :CALC:FPOW:POW1:READ1?
Notes	Option FP2 is required. Returns m 4 byte floating point binary values (Little-Endian), where m corresponds to the number of bandwidths defined.
Initial S/W Revision	A.14.00

Diagnostic Binary Read Fast Power Measurement (Remote Command Only)

This command query is used as shorthand for an INIT command immediately followed by a FETC? command. The returned results are in a binary format. This command is used primarily for diagnostic purposes to test for ADC overloads and to visibly inspect the spectrum.

Mode	All
Remote Command	:CALCulate:FPOWER:POWER[1,2,...,999]:READ2?
Example	:CALC:FPOW:POW1:READ2?
Notes	Option FP2 is required. Note: Spectrum data is only returned if the IncludePowerSpectrum parameter is set to True. If IncludePowerSpectrum is False, the number of spectrum points will be zero (0). Units of the returned values are dependent on the Function parameter per channel (e.g. dBm for BandPower, Hz for PeakFrequency). Returns binary data (Little-Endian) that contains information on m amount of channels, along with ADC over range and full spectrum data. The following is the binary format of the response. Bandwidth Return Value 1. Number of channels specified, m [4 byte int] 2. Declared function result for the 1st specified channel [4 byte float]

	3. Declared function result for the 2nd specified channel [4 byte float]
	...
	(m + 1). Declared function result for the last (mth) specified channel [4 byte float]
	ADC Over Range
	1. ADC over-range occurred (1: true, 0: false) [2 byte short]
	Spectrum Data
	1. Number of points in the spectrum data, k [4 byte int]
	2. Start frequency of spectrum data (Hz) [8 byte double]
	3. Step frequency of spectrum data (Hz) [8 byte double]
	4. FFT bin at 1st point (dBm) [4 byte float]
	5. FFT bin at 2nd point (dBm) [4 byte float]
	...
	(k + 3). FFT bin at last (kth) point (dBm) [4 byte float]

Initial S/W Revision	A.14.00
-------------------------	---------

Format Data: Numeric Data (Remote Command Only)

This command specifies the format of the trace data input and output. It specifies the formats used for trace data during data transfer across any remote port. It affects only the data format for setting and querying trace data for the :TRACe[:DATA], TRACe[:DATA]?, :CALCulate:DATA[n]? and FETCh:SANalyzer [n]? commands and queries.

Remote Command	:FORMat [:TRACe] [:DATA] ASCii INTeger, 32 REAL, 32 REAL, 64 :FORMat [:TRACe] [:DATA] ?
Notes	The query response is: ASCii: ASC,8 REAL,32: REAL,32 REAL,64: REAL,64 INTeger,32: INT,32 When the numeric data format is REAL or ASCii, data is output in the current Y Axis unit. When the data format is INTeger, data is output in units of m dBm (.001 dBm). The INT,32 format returns binary 32-bit integer values in internal units (m dBm), in a definite length block.
Dependencies	Sending a data format spec with an invalid number (for example, INT,48) generates no error. The analyzer simply uses the default (8 for ASCii, 32 for INTeger, 32 for REAL). Sending data to the analyzer which does not conform to the current FORMat specified, results in an error. Sending ASCII data when a definite block is expected generates message -161 "Invalid Block Data" and sending a definite block when ASCII data is expected generates message -121 "Invalid Character in Number".
Preset	ASCii
Backwards Compatibility	Note that the INT,32 format is only applicable to the command, TRACe:DATA. This preserves

Notes	backwards compatibility for the Swept SA measurement. For all other commands/queries which honor FORMat:DATA, if INT,32 is sent the analyzer will behave as though it were set to REAL,32.
Initial S/W Revision	Prior to A.02.00

The specs for each output type follow:

ASCIi - Amplitude values are in ASCII, in the current Y Axis Unit, one ASCII character per digit, values separated by commas, each value in the form:

SX.YYYYYEsZZ

Where:

S = sign (+ or -)

X = one digit to left of decimal point

Y = 5 digits to right of decimal point

E = E, exponent header

s = sign of exponent (+ or -)

ZZ = two digit exponent

REAL,32 - Binary 32-bit real values in the current Y Axis Unit, in a definite length block.

REAL,64 - Binary 64-bit real values in the current Y Axis Unit, in a definite length block.

Format Data: Byte Order (Remote Command Only)

This command selects the binary data byte order for data transfer and other queries. It controls whether binary data is transferred in normal or swapped mode. This command affects only the byte order for setting and querying trace data for the :TRACe[:DATA], TRACe[:DATA]? , :CALCulate:DATA[n]? and FETCh:SANalyzer[n]? commands and queries.

By definition any command that says it uses FORMat:DATA uses any format supported by FORMat:DATA.

The NORMAl order is a byte sequence that begins with the most significant byte (MSB) first, and ends with the least significant byte (LSB) last in the sequence: 1|2|3|4. SWAPped order is when the byte sequence begins with the LSB first, and ends with the MSB last in the sequence: 4|3|2|1.

Remote Command	:FORMat:BORDER NORMAl SWAPped :FORMat:BORDER?
Preset	NORMAl
Initial S/W Revision	Prior to A.02.00

Meas Setup

Displays the setup menu for the current measurement. The measurement setup parameters include the number of measurement averages used to calculate the measurement result and the averaging mode. The setup menu also includes the option to reset the measurement settings to their factory defaults.

Key Path	Front-panel key
Initial S/W Revision	Prior to A.02.00

Avg/Hold Num

Specifies the number of measurement averages used when calculating the measurement result. The average is displayed at the end of each sweep.

Initiates an averaging routine that averages the sweep points in a number of successive sweeps, resulting in trace smoothing.

After the specified number of average counts, the average mode (termination control) setting determines the average action.

Key Path	Meas Setup
Mode	SA, WCDMA, C2K, WIMAX OFDMA, TD-SCDMA, 1xEVDO, ISDB-T, CMMB, LTE, LTETDD, BLUETOOTH, WLAN, MSR, LTEAFDD, LTEATDD
Remote Command	[:SENSe] :OBWidth :AVERage :COUNt <integer> [:SENSe] :OBWidth :AVERage :COUNt ? [:SENSe] :OBWidth :AVERage [:STATe] ON OFF 1 0 [:SENSe] :OBWidth :AVERage [:STATe] ?
Example	OBW:AVER:COUN 1500 OBW:AVER:COUN? OBW:AVER ON OBW:AVER?
Notes	You must be in the Spectrum Analysis mode, W-CDMA mode, cdma2000 mode, TD-SCDMA mode, ISDB-T mode, CMMB mode, LTE mode, LTE TDD mode, BLUETOOTH mode, WLAN mode, 1xEVDO mode, MSR, LTE-Advanced FDD/TDD or WIMAX OFDMA mode to use this command. Use:INSTrument:SElect to set the mode.
Couplings	None Averaging state is coupled to Max Hold. If Max Hold is changed from Off to On, Averaging state is automatically set to On.
Preset	10 ON
State Saved	Saved in instrument state.
Min	1
Max	10000

Backwards Compatibility SCPI	<code>[:SENSe] :EBWidth :AVERage :COUNT</code>
Initial S/W Revision	Prior to A.02.00
Modified at S/W Revision	A.03.00

Avg Mode

Enables you to set the averaging mode.

- When set to Exponential (Exp) the measurement averaging continues using the specified number of averages to compute each averaged value. The average is displayed at the end of each sweep.
- When set to Repeat, the measurement resets the average counter each time the specified number of averages is reached.

Key Path	Meas Setup
Mode	SA, WCDMA, C2K, WIMAX OFDMA, TD-SCDMA, 1xEVDO, ISDB-T, CMMB, LTE, LTETDD, BLUETOOTH, WLAN, MSR, LTEAFDD, LTEATDD
Remote Command	<code>[:SENSe] :OBWidth :AVERage :TCONtrol EXPonential REPeat</code> <code>[:SENSe] :OBWidth :AVERage :TCONtrol ?</code>
Example	OBW:AVER:TCON REP OBW:AVER:TCON?
Notes	You must be in the Spectrum Analysis mode, W-CDMA mode, cdma2000 mode, TD-SCDMA mode, ISDB-T mode, CMMB mode, LTE mode, LTE TDD mode, BLUETOOTH mode, WLAN mode, 1xEVDO mode, MSR, LTE-Advanced FDD/TDD or WIMAX OFDMA mode to use this command. Use:INSTRument:SElect to set the mode.
Preset	EXP
State Saved	Saved in instrument state.
Range	Exp Repeat
Initial S/W Revision	Prior to A.02.00
Modified at S/W Revision	A.03.00

Occ BW % Pwr

Assigns the percentage of the total power that is measured within the Occupied Bandwidth for the current measurement. The resulting Occupied Bandwidth limits are displayed by markers placed on the frequencies of the specified percentage.

Key Path	Meas Setup
Mode	SA, WCDMA, C2K, WIMAX OFDMA, TD-SCDMA, 1xEVDO, ISDB-T, CMMB, LTE, LTETDD, BLUETOOTH, WLAN, MSR, LTEAFDD, LTEATDD
Remote Command	<code>[:SENSe] :OBWidth :PERCent <real></code>

	<code>[:SENSe] :OBWidth:PERCent?</code>
Example	OBW:PERC 75 OBW:PERC?
Notes	You must be in the Spectrum Analysis mode, W-CDMA mode, cdma2000 mode, TD-SCDMA mode, ISDB-T mode, CMMB mode, LTE mode, LTE TDD mode, BLUETOOTH mode, WLAN mode, 1xEVDO mode, MSR, LTE-Advanced FDD/TDD or WIMAX OFDMA mode to use this command. Use:INSTrument:SElect to set the mode. If Mode is BLUETOOTH, the key will be grayed out.
Preset	99.00
State Saved	Saved in instrument state.
Min	10
Max	99.99
Initial S/W Revision	Prior to A.02.00
Modified at S/W Revision	A.03.00

Power Ref

This key enables you to select Power Ref Type.

- Total Power – Total power in the current span is displayed.
- OBW Power – With the OBW percent power, occupied power is displayed.

When Power Ref type is changed, the annotation in the lower window and Remote Command SCPI Results also change.

Key Path	Meas Setup
Remote Command	<code>[:SENSe] :OBWidth:PREFerence TPOWer OBWPower</code> <code>[:SENSe] :OBWidth:PREFerence?</code>
Example	OBW:PREF TPOW OBW:PREF?
Preset	TPOWer
State Saved	Saved in instrument state
Range	TPOWer OBWPower
Initial S/W Revision	A.16.00

x dB

Sets the x dB value used for the "x dB bandwidth" result that measures the bandwidth between two points on the signal which is x dB down from the highest signal point within the OBW Span.

Key Path	Meas Setup
Mode	SA, WCDMA, C2K, WIMAX OFDMA, TD-SCDMA, 1xEVDO, ISDB-T, CMMB, LTE, LTETDD, BLUETOOTH, WLAN, MSR, LTEAFDD, LTEATDD
Remote Command	<code>[:SENSe]:OBWidth:XDB <rel_ampl></code> <code>[:SENSe]:OBWidth:XDB?</code>
Example	OBW:XDB -20 OBW:XDB?
Notes	You must be in the Spectrum Analysis mode, W-CDMA mode, cdma2000 mode, TD-SCDMA mode, ISDB-T mode, CMMB mode, LTE mode, LTE TDD mode, BLUETOOTH mode, WLAN mode, 1xEVDO mode, MSR, LTE-Advanced FDD/TDD or WIMAX OFDMA mode to use this command. Use:INSTRument:SElect to set the mode.
Preset	-26.0 dB BLUETOOTH: -20.0 dB.
State Saved	Saved in instrument state.
Min	-100.0 dB
Max	-0.1 dB
Backwards Compatibility SCPI	<code>[:SENSe]:EBWidth:XDB</code>
Initial S/W Revision	Prior to A.02.00
Modified at S/W Revision	A.03.00

Limit (for all modes except MSR and LTE-Advanced FDD/TDD)

Enables you to turn on or off limit checking at the specified frequency. For results that fail the limit test, a red FAIL appears in the measure bar.

Key Path	Meas Setup
Mode	SA, WCDMA, C2K, WIMAX OFDMA, TD-SCDMA, 1xEVDO, ISDB-T, CMMB, LTE, LTETDD, BLUETOOTH, WLAN
Remote Command	<code>:CALCulate:OBWidth:LIMit:FBLimit <freq></code> <code>:CALCulate:OBWidth:LIMit:FBLimit?</code> <code>:CALCulate:OBWidth:LIMit[:TEST] ON OFF 1 0</code> <code>:CALCulate:OBWidth:LIMit[:TEST]?</code>
Example	CALC:OBW:LIM:FBL 50 kHz CALC:OBW:LIM:FBL? CALC:OBW:LIM OFF CALC:OBW:LIM?
Notes	You must be in the Spectrum Analysis mode, W-CDMA mode, cdma2000 mode, TD-SCDMA mode, ISDB-T mode, CMMB mode, LTE mode, LTE TDD mode, BLUETOOTH mode, WLAN mode, 1xEVDO mode or WIMAX OFDMA mode to use this command. Use:INSTRument:SElect to set the mode.

Preset	SA, WCDMA: 5 MHz C2K: 1.48 MHz WIMAX OFDMA: 10 MHz TD-SCDMA: 1.6 MHz 1xEVDO: 1.48 MHz ISDB-T: 5.7 MHz CMMB: 7.512 MHz LTE, LTETDD: 5 MHz BLUETOOTH: 1 MHz WLAN: If Radio Std is 802.11a/g(OFDM/DSSS-OFDM): 20MHz If Radio Std is 802.11b: 25 MHz If Radio Std is 802.11n(20MHz): 20 MHz If Radio Std is 802.11n(40MHz): 40 MHz If Radio Std is 802.11ac(20MHz): 20 MHz If Radio Std is 802.11ac(40MHz): 40 MHz If Radio Std is 802.11ac(80MHz): 80 MHz If Radio Std is 802.11ac(160MHz): 160 MHz SA: OFF WCDMA, WIMAX OFDMA, TD-SCDMA, 1xEVDO, ISDB-T, CMMB, LTE, LTETDD: ON
State Saved	Saved in instrument state.
Min	1 kHz
Max	Depends on instrument maximum frequency.
Initial S/W Revision	Prior to A.02.00
Modified at S/W Revision	A.03.00

Meas Preset

Restores all measurement parameters to their default values.

Key Path	Meas Setup
Mode	SA, WCDMA, C2K, WIMAX OFDMA, TD-SCDMA, 1xEVDO, ISDB-T, CMMB, LTE, LTETDD, BLUETOOTH, WLAN, MSR, LTEAFDD, LTEATDD
Remote Command	:CONFigure:OBWidth
Example	CONF:OBW
Initial S/W Revision	Prior to A.02.00
Modified at S/W Revision	A.03.00

Max Hold (Remote Command Only)

When On, Max Hold displays and holds the maximum responses of the current measurement. Turn Max Hold to Off to disable the maximum hold feature.

Key Path	SCPI Only
Mode	SA, WCDMA, C2K, WIMAX OFDMA, TD-SCDMA, 1xEVDO, ISDB-T, CMMB, LTE, LTETDD, BLUETOOTH, WLAN, MSR, LTEAFDD, LTEATDD
Remote Command	<code>[:SENSe] :OBwidth:MAXHold ON OFF 1 0</code> <code>[:SENSe] :OBwidth:MAXHold?</code>
Example	OBW:MAXH ON OBW:MAXH?
Notes	You must be in the Spectrum Analysis mode, W-CDMA mode, cdma2000 mode, TD-SCDMA mode, ISDB-T mode, CMMB mode, LTE mode, LTE TDD mode, BLUETOOTH mode, WLAN mode, 1xEVDO mode, MSR, LTE-Advanced FDD/TDD or WIMAX OFDMA mode to use this command. Use:INSTrument:SElect to set the mode.
Couplings	Max Hold is coupled to Average/Hold state. The Max Hold function is activated only if Average state is On. If Max Hold is changed to On when Average state is Off, Average state is automatically set to On.
Preset	OFF
State Saved	Saved in instrument state.
Range	On Off
Backwards Compatibility SCPI	<code>[:SENSe] :EBwidth:MAXHold</code>
Initial S/W Revision	Prior to A.02.00
Modified at S/W Revision	A.03.00

11 Occupied Bandwidth Measurement
Mode

Mode

See "[Mode](#)" on page 162

Mode Preset

Returns the active mode to a known state.

Mode Preset does the following for the currently active mode:

- Aborts the currently running measurement.
- Brings up the default menu for the mode, with no active function.
- Sets measurement Global settings to their preset values for the active mode only.
- Activates the default measurement.
- Brings up the default menu for the mode.
- Clears the input and output buffers.
- Sets Status Byte to 0.

Mode Preset does not:

- Cause a mode switch
- Affect mode persistent settings
- Affect system settings
- See "[How-To Preset](#)" on page 1286 for more information.

Key Path	Front-panel key
Remote Command	:SYSTem:PRESet
Example	:SYST:PRES
Notes	*RST is preferred over :SYST:PRES for remote operation. *RST does a Mode Preset, as done by the :SYST:PRES command, and it sets the measurement mode to Single measurement rather than Continuous for optimal remote control throughput. Clears all pending OPC bits. The Status Byte is set to 0.
Couplings	A Mode Preset aborts the currently running measurement, activates the default measurement, and gets the mode to a consistent state with all of the default couplings set.
Backwards Compatibility Notes	In the X-Series, the legacy "Factory Preset" has been replaced with Mode Preset, which only presets the currently active mode, not the entire instrument. In the X-Series, the way to preset the entire instrument is by using System, Restore System Defaults All, which behaves essentially the same way as restore System Defaults does on ESA and PSA. There is also no "Preset Type" as there is on the PSA. There is a green Mode Preset front-panel key that does a Mode Preset and a white-with-green-letters User Preset front-panel key that does a User Preset. The old PRESet:TYPE command is ignored (without generating an error), and SYST:PRES without a parameter does a Mode Preset, which should cover most backward code compatibility issues. The settings and correction data under the Input/Output front-panel key (examples: Input Z Corr, Ext Amp Gain, etc.) are no longer part of any Mode, so they will not be preset by a Mode Preset. They are preset using Restore Input/Output Defaults, Restore System Defaults All. Note that because User Preset does a Recall State, and all of these settings are saved in State, they ARE recalled when using

	User Preset.
Initial S/W Revision	Prior to A.02.00

How-To Preset

The table below shows all possible presets, their corresponding SCPI commands and front-panel access (key paths). Instrument settings depend on the current measurement context. Some settings are local to the current measurement, some are global (common) across all the measurements in the current mode, and some are global to all the available modes. In a similar way, restoring the settings to their preset state can be done within the different contexts.

Auto Couple - is a measurement local key. It sets all Auto/Man parameter couplings in the measurement to Auto. Any Auto/Man selection that is local to other measurements in the mode will not be affected.

Meas Preset - is a measurement local key. Meas Preset resets all the variables local to the current measurement except the persistent ones.

Mode Preset - resets all the current mode's measurement local and measurement global variables except the persistent ones.

Restore Mode Defaults - resets ALL the Mode variables (and all the Meas global and Meas local variables), including the persistent ones.

Type Of Preset	SCPI Command	Front Panel Access
Auto Couple	:COUPle ALL	Auto Couple front-panel key
Meas Preset	:CONFigure:<Measurement>	Meas Setup Menu
Mode Preset	:SYSTem:PRESet	Mode Preset (green key)
Restore Mode Defaults	:INSTrument:DEFault	Mode Setup Menu
Restore All Mode Defaults	:SYSTem:DEFault MODes	System Menu; Restore System Default Menu
*RST	*RST	not possible (Mode Preset with Single)
Restore Input/Output Defaults	:SYSTem:DEFault INPUt	System Menu; Restore System Default Menu
Restore Power On Defaults	:SYSTem:DEFault PON	System Menu; Restore System Default Menu
Restore Alignment Defaults	:SYSTem:DEFault ALIGN	System Menu; Restore System Default Menu
Restore Miscellaneous Defaults	:SYSTem:DEFault MISC	System Menu; Restore System Default Menu
Restore All System Defaults	:SYSTem:DEFault [ALL] :SYSTem:PRESet:PERsistent	System Menu; Restore System Default Menu
User Preset	:SYSTem:PRESet:USER	User Preset Menu
User Preset All Modes	:SYSTem:PRESet:USER:ALL	User Preset Menu

Power On Mode Preset	:SYSTem:PON:TYPE MODE	System Menu
Power On User Preset	:SYSTem:PON:TYPE USER	System Menu
Power On Last State	:SYSTem:PON:TYPE LAST	System Menu

Mode Setup

See "[Mode Setup](#)" on page 181

Peak Search

Places the selected marker on the trace point with the maximum y-axis value for that marker's trace. Pressing Peak Search with the selected marker off causes the selected marker to be set to Normal, then a peak search is immediately performed.

Key Path	Front panel key
Mode	SA, WCDMA, C2K, WIMAX OFDMA, TD-SCDMA, 1xEVDO, ISDB-T, CMMB, LTE, LTETDD, BLUETOOTH, WLAN, MSR, LTEAFDD, LTEATDD
Remote Command	:CALCulate:OBWidth:MARKer[1] 2 ... 12:MAXimum
Example	CALC:OBW:MARK2:MAX
Initial S/W Revision	Prior to A.02.00
Modified at S/W Revision	A.03.00

11 Occupied Bandwidth Measurement
Print

Print

See "[Print](#) " on page 188

Quick Save

The Quick Save front-panel key repeats the most recent save that was performed from the Save menu, with the following exceptions:

- Register saves are not remembered as Saves for the purpose of the Quick Save function
- If the current measurement does not support the last non-register save that was performed, an informational message is generated, “File type not supported for this measurement”

Quick Save repeats the last type of qualified save (that is, a save qualified by the above criteria) in the last save directory by creating a unique filename using the Auto File Naming algorithm described below.

If Quick Save is pressed after startup and before any qualified Save has been performed, the Quick Save function performs a Screen Image save using the current settings for Screen Image saves (current theme, current directory), which then becomes the “last save” for the purpose of subsequent Quick Saves.

The Auto File Naming feature automatically generates a file name for use when saving a file. The filename consists of a prefix and suffix separated by a dot, as is standard for the Windows® file system. A default prefix exists for each of the available file types:

Type	Default Prefix	Menu
State	State_	(Save/Recall)
Trace + State	State_	(Save/Recall)
Screen	Screen_	(Save/Recall)
Amplitude Corrections	Ampcor_	(Import/Export)
Traces	Trace_	(Import/Export)
Limit Lines	LLine_	(Import/Export)
Measurement Result	MeasR_	(Import/Export)
Capture Buffer	CapBuf_	(Import/Export)

A four digit number is appended to the prefix to create a unique file name. The numbering sequence starts at 0000 within each Mode for each file type and updates incrementally to 9999, then wraps to 0000 again. It remembers where it was through a Mode Preset and when leaving and returning to the Mode. It is reset by Restore Misc Defaults and Restore System Defaults and subsequent running of the instrument application. So, for example, the first auto file name generated for State files is State_0000.state. The next is State_0001, and so forth.

One of the key features of Auto File Name is that we guarantee that the Auto File Name will never conflict with an existing file. The algorithm looks for the next available number. If it gets to 9999, then it looks for holes. If it find no holes, that is no more numbers are available, it gives an error.

For example, if when we get to State_0010.state there is already a State_0010.state file in the current directory, it advances the counter to State_0011.state to ensure that no conflict will exist (and then it verifies that State_0011.state also does not exist in the current directory and advances again if it does, and so forth).

If you enter a file name for a given file type, then the prefix becomes the filename you entered instead of the default prefix, followed by an underscore. The last four letters (the suffix) are the 4-digit number.

For example, if you save a measurement results file as “fred.csv”, then the next auto file name chosen for a measurement results save will be fred_0000.csv.

NOTE Although 0000 is used in the example above, the number that is used is actually the current number in the Meas Results sequence, that is, the number that would have been used if you had not entered your own file name.

NOTE If the filename you entered ends with _dddd, where d=any number, making it look just like an auto file name, then the next auto file name picks up where you left off with the suffix being dddd + 1.

Key Path	Front-panel key
Notes	No remote command for this key specifically.
Initial S/W Revision	Prior to A.02.00

Recall

The Recall menu lets you choose what you want to recall, and where you want to recall it from. Among the types of files you can recall are **States and Traces**. In addition, an Import (Data) option lets you recall a number of data types stored in CSV files (as used by Excel and other spreadsheet programs).

NOTE

In products that run multiple instances of the X-Series Application, all instances share the same register and file location where you want to recall from.

The default paths for Recall are data type dependent and are the same as for the Save key.

Key Path	Front-panel key
Notes	<p>No remote command for this key specifically, but the :MMEM:LOAD command is available for specific file types. An example is :MMEM:LOAD:STATE <filename>.</p> <p>If you try to recall a State file for a mode that is not licensed or not available in the instrument, an error message will occur and the state will not change.</p>
Backwards Compatibility Notes	<p>In legacy analyzers, it was possible to load a state without affecting the trace data, limit lines or correction data. Similarly (since User Preset is actually loading a state), it was possible to do a User Preset without affecting the trace data, limit lines or correction data.</p> <p>In the X-Series, “state” always includes all of this data; so whenever state is loaded, all of the traces, limit lines and corrections are affected. Although this differs from previous behavior, it is desirable behavior, and should not cause adverse issues for users.</p>
Backwards Compatibility Notes	<p>Recall for the X-Series supports backward compatibility in the sense that you can recall a state file from any X-Series model number and any version of X-Series software. This is only possible if part of the recalling process goes through a limiting step after recalling the mode settings, at least for settings that may vary with version number, model number, option and license differences. If you try to recall a state file onto an instrument with less capability than what was available on the instrument during the save, the recall will ignore the state it doesn't support and it will limit the recalled setting to what it allows.</p> <p>Example: if the saved state includes preamp ON, but the recalling instrument does not have a preamp; the preamp is limited to OFF. Conversely, if you save a state without a preamp, the preamp is OFF in the state file. When this saved file is recalled on an instrument with a licensed preamp, the preamp is changed to OFF. Another example is if the saved state has center frequency set to 20 GHz, but the instrument recalling the saved state is a different model and only supports 13.5 GHz. In this case, the center frequency is limited along with any other frequency based settings. Since the center frequency can't be preserved in this case, the recall limiting tries to at least preserve span to keep the measurement setup as intact as possible.</p> <p>It may be appropriate to issue a warning if the state is limited on the recall; warnings do not go out to SCPI so this would only affect the manual user.</p> <p>Note that there is no state file compatibility outside of the X-Series. For example, you cannot recall a state file from ESA or PSA.</p>
Initial S/W Revision	Prior to A.02.00

State

The Recall State menu lets you choose a register or file from which to recall the state.

The content of a state file includes all of the settings and data required to return the analyzer as closely as possible to the Mode it was in, with the exact settings that were in place, when the save occurred. The Mode settings in each state file include the settings that are affected by Mode Preset, as well as the additional settings affected by Restore Mode Defaults; all of the Mode's settings. In addition, all of the settings of the Input/Output system are included, even though they are outside of the Mode's state, because they are needed to restore the complete setup. Persistent System settings (for example, GPIB address) are not affected by either a Mode Preset or Restore Mode Defaults, nor are they included in a saved State file.

Since each state file is only for one Mode, the settings for other Modes are unaffected when it is loaded. Recall State will cause a mode switch if the state being recalled is not from the current active mode.

After the recall completes, the message "File <filename> recalled" or "Recalled State Register <register number>" is displayed.

For rapid recalls, the State menu lists 16 registers that you can choose from to recall. Pressing a Register key initiates the recall. You can also select a file from which to recall.

The default path for all State Files is:

My Documents\<mode name>\state

where <mode name> is the parameter used to select the mode with the INST:SEL command (for example, SA for the Spectrum Analyzer).

See ["More Information" on page 1295](#).

Key Path	Recall
Mode	All
Remote Command	:MMEMory:LOAD:STATe <filename>
Example	:MMEM:LOAD:STAT "myState.state" This recalls the file myState.state on the default path
Example	MMEM:LOAD:STAT "MyStateFile.state" This loads the state file data (on the default file directory path) into the instrument state.
Notes	<p>When you pick a file to recall, the analyzer first verifies that the file is recallable in the current instrument by checking the software version and model number of the instrument. If everything matches, a full recall proceeds by aborting the currently running measurement, clearing any pending operations, and then loading the State from the saved state file. You can open state files from any mode, so recalling a State file switches to the mode that was active when the save occurred. After switching to the mode of the saved state file, mode settings and data (if any for the mode) are loaded with values from the saved file. The saved measurement of the mode becomes the newly active measurement and the data relevant to the measurement (if there is any) is recalled.</p> <ul style="list-style-type: none"> • If there is a mismatch between file version or model number or instrument version or model number, the recall function tries to recall as much as possible and returns a warning message. It may limit settings that differ based on model number, licensing or version number. <p>After recalling the state, the Recall State function does the following:</p> <ul style="list-style-type: none"> • Makes the saved measurement for the mode the active measurement. • Clears the input and output buffers. • Status Byte is set to 0.

	<ul style="list-style-type: none"> • Executes a *CLS <p>If the file specified is empty an error is generated. If the specified file does not exist, another error is generated. If there is a mismatch between the file and the proper file type, an error is generated. If there is a mismatch between file version or model number or instrument version or model number, a warning is displayed. Then it returns to the State menu and File Open dialog goes away.</p> <p>After the Recall, the analyzer exits the Recall menu and returns to the previous menu.</p>
Backwards Compatibility SCPI	:MMEMory:LOAD:STATe 1,<filename>
Initial S/W Revision	Prior to A.02.00

More Information

In measurements that support saving Traces, for example, Swept SA, the Trace data is saved along with the State in the State file. When recalling the State, the Trace data is recalled as well. Traces are recalled exactly as they were stored, including the writing mode and update and display modes. If a Trace was updating and visible when the State was saved, it will come back updating and visible, and its data will be rewritten right away. When you use State to save and recall traces, any trace whose data must be preserved should be placed in View or Blank mode before saving.

The following table describes the Trace Save and Recall possibilities:

You want to recall state and one trace's data, leaving other traces unaffected.	Save Trace+State from 1 trace. Make sure that no other traces are updating (they should all be in View or Blank mode) when the save is performed.	On Recall, specify the trace you want to load the one trace's data into. This trace will load in View. All other traces' data will be unaffected, although their trace mode will be as it was when the state save was performed.
You want to recall all traces	Save Trace+State from ALL traces.	On Recall, all traces will come back in View (or Blank if they were in Blank or Background when saved)
You want all traces to load exactly as they were when saved.	Save State	On recall, all traces' mode and data will be exactly as they were when saved. Any traces that were updating will have their data immediately overwritten.

From File...

When you press "From File", the analyzer brings up a Windows dialog and a menu entitled "File Open." This menu allows you to navigate to the various fields in the Windows dialog without using a keyboard or mouse. The Tab and Arrow keys can also be used for dialog navigation.

11 Occupied Bandwidth Measurement Recall

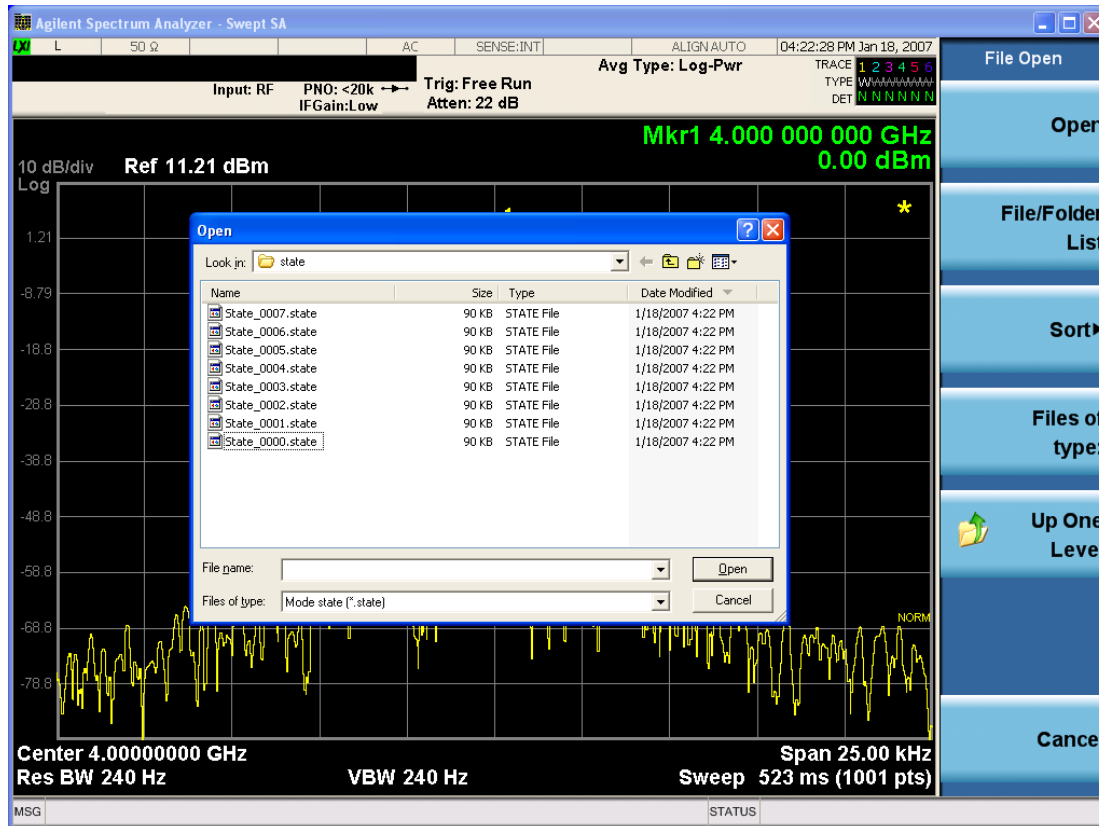

Listed below are the functions of the various fields in the dialog, and the corresponding softkeys:

Open

Performs the recall of the specified file. While the recall is being performed, the floppy icon appears briefly in the Meas bar.

File/Folder List

Enables you to navigate to the center of the dialog that contains the list of files and folders. Once here you can get information about the file and use the tab keys to navigate to the other fields in the dialog, such as Look In.

Look In

The Look In field shows the path from which the file will be recalled and allows you to change the path using the up and down arrow keys to navigate to other paths; the Enter key to open a directory; and the Backspace key to go back one directory. The **Look In field** first uses the last path from the Save As dialog **Save In:** path for that same file type. There is no softkey for directly navigating to the Look In field, but you can use the left tab to get here from the File/Folder List.

User specified paths are remembered when you leave and return to a Mode and are reset back to the default using Restore Mode Defaults.

Sort

Accesses a menu that enables you to sort the files within the File Open dialog. Only one sorting type can be selected at a time and the sorting happens immediately. The sorting types are By Date, By Name, By extension, and By Size.

Files of Type

This field shows the file suffix for the type of file you have selected to recall. For example, if you navigated here while recalling State, "Mode state (*.state)" is in the field. If you navigated here while recalling Trace, ""Mode state (*.trace)" is in the field. If you navigated here while importing a trace data file, "Trace Data (*.csv)" is in the field. For some file types, there is more than one choice in the dropdown menu, which you can select by using the up and down arrow keys and Enter.

Up One Level

This key corresponds to the icon of a folder with the up arrow that is in the tool bar of the dialog. When pressed, it causes the file and folder list to navigate up one level in the directory structure. The Backspace key does the same thing.

Cancel

This key corresponds to the Cancel selection in the dialog. It causes the current **Open** request to be cancelled. The ESC key does the same thing.

Key Path	Recall, State
Notes	Brings up the Open dialog for recalling a State Save Type
Initial S/W Revision	Prior to A.02.00

Edit Register Names

You may enter a custom name on any of the Register keys, to help you remember what you are using that state to save. To do this, press the Edit Register Names key, choose the register whose name you wish to edit, and then enter the desired label using the Alpha Editor or an external PC keyboard.

The maximum number of characters that can be added is 30. In most cases, 30 characters will fit on two lines of the key.

For more information and the SCPI command, see Edit Register Names under the Save, State function.

Key Path	Recall, State
Mode	All
Dependencies	N9060A-7FP or N9060B-2FP license required to edit the register names. When the feature is not licensed, sending the SCPI command generates an error, -221, "Settings conflict;Option not available"
Initial S/W Revision	A.11.00

Register 1 thru Register 16

Selecting any one of these register keys causes the State of the mode from the specified Register to be recalled. Each of the register keys annotates whether it is empty or at what date and time it was last

modified. In addition, you can use the Edit Register Names key under Save, State to enter custom names for each register.

NOTE In products that run multiple instances of the X-Series Application, recalling the same register name on each instance is a way to share setups between the instances.

Registers are shared by all modes, so recalling from any one of the registers will cause a mode switch to the mode that was active when the save to the Register occurred.

Although these 16 registers are the only registers available from the front panel, there are 128 state registers available in the instrument. Registers 17–128 are only available from the SCPI interface, using the *RCL command.

After the recall completes, the message "Register <register number> recalled" appears in the message bar. If you are in the Spectrum Analyzer Mode, and you are recalling a register that was saved in the Spectrum Analyzer Mode, then after the recall, you will still be in the Recall Register menu. If the Recall causes you to switch modes, then after the Recall, you will be in the Frequency menu.

If a requested register is empty an error is generated.

Key Path	Recall, State
Example	*RCL 1
Range	1–16 from front panel, 1–128 from SCPI
Readback	Date and time with seconds resolution are displayed on the key OR A custom name of up to 30 characters entered using the Save, State, Edit Register Names key OR “(empty)” if no prior save operation has been performed to this register.
Initial S/W Revision	Prior to A.02.00
Modified at S/W Revision	Prior to A.11.00

Register 1 thru Register 16

Selecting any one of these register keys causes the State of the mode from the specified Register to be recalled. Each of the register keys annotates whether it is empty or at what date and time it was last modified. In addition, you can use the Edit Register Names key under Save, State to enter custom names for each register.

NOTE In products that run multiple instances of the X-Series Application, recalling the same register name on each instance is a way to share setups between the instances.

Registers are shared by all modes, so recalling from any one of the registers will cause a mode switch to the mode that was active when the save to the Register occurred.

Although these 16 registers are the only registers available from the front panel, there are 128 state registers available in the instrument. Registers 17–128 are only available from the SCPI interface, using the *RCL command.

After the recall completes, the message "Register <register number> recalled" appears in the message bar. If you are in the Spectrum Analyzer Mode, and you are recalling a register that was saved in the Spectrum Analyzer Mode, then after the recall, you will still be in the Recall Register menu. If the Recall causes you to switch modes, then after the Recall, you will be in the Frequency menu.

If a requested register is empty an error is generated.

Key Path	Recall, State
Example	*RCL 1
Range	1-16 from front panel, 1-128 from SCPI
Readback	Date and time with seconds resolution are displayed on the key OR A custom name of up to 30 characters entered using the Save, State,Edit Register Names key OR “(empty)” if no prior save operation has been performed to this register.
Initial S/W Revision	Prior to A.02.00
Modified at S/W Revision	Prior to A.11.00

Sequences

These keys allow you to import a Tab separated or .txt file that will automatically setup all the parameters required for building a Sequence. The parameters will automatically be loaded into the Stated Sequencer.

Once selected, in order to import the selected Sequence Type you must select the Open key in the Source Sequence menu.

Key Path	Recall, Sequences
Mode	All
Remote Command	:MMEMory:LOAD:SEquences: SLIS ALIS SAALIS "MySequence.txt"
Example	:MMEM:LOAD:SEQ:SLIS "MySequence.txt"
Notes	Available file types are: –CSV (Comma delimited) (*.csv) –Text (Tab delimited) (*.txt)
Initial S/W Revision	A.05.00

Source Sequence

The list of parameters, that configure steps, that makes up a sequence for the Source.

The Source sequence is a sequence of flexible configurable steps that can be set anywhere in the instruments frequency range.

Key Path	Recall,Sequences
----------	------------------

Example	:MMEM:LOAD:SEQ:SLIS "MySequence.txt"
Dependencies	Only available in XOBT
Initial S/W Revision	A.05.00

Open...

When you press “Open”, the analyzer brings up a Windows dialog and a menu entitled “**File Open.**” This menu allows you to navigate to the various fields in the Windows dialog without using a keyboard or mouse. The Tab and Arrow keys can also be used for dialog navigation.

See "[From File...](#)" on page 2060 in Recall, State, for a full description of this dialog and menu.

Key Path	Recall, Data
Notes	The key location is mode-dependent and will vary. Brings up Open dialog for recalling a <mode specific> Save Type
Initial S/W Revision	Prior to A.02.00

Data (Import)

Importing a data file loads data that was previously saved from the current measurement or from other measurements and/or modes that produce compatible data files. The Import Menu only contains Data Types that are supported by the current measurement.

Since the commonly exported data files are in .csv format, the data can be edited by the user prior to importing. This allows you to export a data file, manipulate the data in Excel (the most common PC Application for manipulating .csv files) and then import it.

Importing Data loads measurement data from the specified file into the specified or default destination, depending on the data type selected. Selecting an Import Data menu key will not actually cause the importing to occur, since the analyzer still needs to know from where to get the data. Pressing the Open key in this menu brings up the Open dialog and Open menu that provides you with the options from where to recall the data. Once a filename has been selected or entered in the Open menu, the recall occurs as soon as the Open button is pressed.

Key Path	Recall
Mode	All
Notes	The menu is built from whatever data types are available for the mode. Some keys will be missing completely, so the key locations in the sub-menu will vary. No SCPI command directly controls the Data Type that this key controls. The Data Type is included in the MMEM:LOAD commands.
Dependencies	If a file type is not used by a certain measurement, it is grayed out for that measurement. The key for a file type will not show at all if there are no measurements in the Mode that support it.
Preset	Is not affected by Preset or shutdown, but is reset during Restore Mode Defaults

Readback	The data type that is currently selected
Initial S/W Revision	Prior to A.02.00

Capture Buffer

Capture buffer functionality is available only in Code Domain and Modulation Accuracy measurements. The captured data is raw data which is not processed.

Key Path	Recall, Data
Mode	CDMA2000
Example	MMEM:LOAD:CAPT "MyCaptureData.bin" This loads the file of capture data (on the default file directory path) into the instrument.
Dependencies	Capture buffer data is only available for Code Domain and Modulation Accuracy measurement. In other measurements, this key is grayed out.

Open...

When you press "Open", the analyzer brings up a Windows dialog and a menu entitled "**File Open.**" This menu allows you to navigate to the various fields in the Windows dialog without using a keyboard or mouse. The Tab and Arrow keys can also be used for dialog navigation.

See "[From File...](#)" on page 2060 in Recall, State, for a full description of this dialog and menu.

Key Path	Recall, Data
Notes	The key location is mode-dependent and will vary. Brings up Open dialog for recalling a <mode specific> Save Type
Initial S/W Revision	Prior to A.02.00

Restart

The Restart function restarts the current sweep, or measurement, or set of averaged/held sweeps or measurements. If you are Paused, pressing Restart does a Resume.

The Restart function is accessed in several ways:

- Pressing the Restart key
- Sending the remote command INIT:IMMediate
- Sending the remote command INIT:REStart

See "[More Information](#)" on page 1302

Key Path	Front-panel key
Remote Command	:INITiate[:IMMediate] :INITiate:REStart
Example	:INIT:IMM :INIT:REST
Notes	:INITiate:REStart and :INITiate:IMMediate perform exactly the same function.
Couplings	Resets average/hold count k. For the first sweep overwrites all active (update=on) traces with new current data. For application modes, it resets other parameters as required by the measurement.
Status Bits/OPC dependencies	This is an Overlapped command. The STATus:OPERation register bits 0 through 8 are cleared. The STATus:QUESTionable register bit 9 (INTegrity sum) is cleared. The SWEEPING bit is set. The MEASURING bit is set.
Backwards Compatibility Notes	For Spectrum Analysis mode in ESA and PSA, the Restart hardkey and the INITiate:REStart command restart trace averages (displayed average count reset to 1) for a trace in Clear Write, but did not restart Max Hold and Min Hold. In the X-Series, the Restart hardkey and the INITiate:REStart command restart not only Trace Average, but MaxHold and MinHold traces as well. For wireless comms modes in ESA and PSA, the Restart hardkey and the INITiate:REStart command restart every measurement, which includes all traces and numeric results. There is no change to this operation.
Initial S/W Revision	Prior to A.02.00

More Information

The **Restart** function first aborts the current sweep/measurement as quickly as possible. It then resets the sweep and trigger systems, sets up the measurement and initiates a new data measurement sequence with a new data acquisition (sweep) taken once the trigger condition is met.

If the analyzer is in the process of aligning when **Restart** is executed, the alignment finishes before the restart function is performed.

Even when set for Single operation, multiple sweeps may be taken when Restart is pressed (for example, when averaging/holding is on). Thus when we say that **Restart** "restarts a measurement," we may mean:

- It restarts the current sweep
- It restarts the current measurement
- It restarts the current set of sweeps if any trace is in Trace Average, Max Hold or Min Hold
- It restarts the current set of measurements if Averaging, or Max Hold, or Min Hold is on for the measurement
- depending on the current settings.

With **Average/Hold Number** (in **Meas Setup** menu) set to 1, or Averaging off, or no trace in Trace Average or Hold, a single sweep is equivalent to a single measurement. A single sweep is taken after the trigger condition is met; and the analyzer stops sweeping once that sweep has completed. However, with **Average/Hold Number** >1 and at least one trace set to **Trace Average, Max Hold, or Min Hold (SA Measurement)** or **Averaging on (most other measurements)**, multiple sweeps/data acquisitions are taken for a single measurement. The trigger condition must be met prior to each sweep. The sweep is stopped when the average count k equals the number N set for **Average/Hold Number**. A measurement average usually applies to all traces, marker results, and numeric results; but sometimes it only applies to the numeric results.

Once the full set of sweeps has been taken, the analyzer will go to idle state. To take one more sweep without resetting the average count, increment the average count by 1, by pressing the step up key while **Average/Hold Number** is the active function, or sending the remote command `CALC:AVER:TCON UP`.

Save

The Save menu lets you choose what you want to save and where you want to save it. Among the types of files you can save are **States**, **Traces**, and **Screen Images**. In addition, an Export (Data) option lets you save a number of data types as CSV files for easy import into Excel and other spreadsheet programs.

Key Path	Front-panel key
Mode	All
Notes	No remote command for this key specifically, but the :MMEM:STORe command is available for specific file types. An example is :MMEM:STOR:STATe <filename>.
Initial S/W Revision	Prior to A.02.00

State

The Save State menu lets you choose a register or file for saving the state.

NOTE In products that run multiple instances of the X-Series Application, all instances share the same register and file location where you want to save the state.

The content of a state file includes all of the settings and data required to return the analyzer as closely as possible to the Mode it was in, with the exact settings which were in place, when the save occurred. The Mode settings in each state file include the settings that are affected by Mode Preset, as well as the additional settings affected by Restore Mode Defaults; all of the Mode's settings. In addition, all of the settings of the Input/Output system are included, even though they are outside of the Mode's state, because they are needed to restore the complete setup. Persistent System settings (for example, Verbose SCPI) are not affected by either Mode Preset or Restore Mode Defaults, nor are they included in a saved State file.

After the save completes, the message "File <filename> saved" or "State Register <register number> saved" is displayed.

For rapid saving, the State menu lists 16 registers to save to. Pressing a Register key initiates the save. You can also select a file to save to.

The default path for all State Files is:

My Documents\<<mode name>\state

where <mode name> is the parameter used to select the mode with the INST:SEL command (for example, SA for the Spectrum Analyzer).

Key Path	Save
Mode	All
Remote Command	:MMEMory:STORe:STATe <filename>
Example	MMEM:STOR:STATe "MyStateFile.state" This stores the current instrument state data in the file MyStateFile.state in the default directory.
Notes	Both single and double quotes are supported for any filename parameter over remote.

After saving to a register, that register's menu key is updated with the date the time, unless a custom label has been entered for that key.

After saving to a register, you remain in the Save State menu, so that you can see the Register key update. After saving to a file, the analyzer automatically returns to the previous menu and any Save As dialog goes away.

Backwards Compatibility SCPI :MMEMory:STORe:STATe 1,<filename>

For backwards compatibility, the above syntax is supported. The "1" is simply ignored. The command is sequential.

Initial S/W Revision Prior to A.02.00

To File . . .

When you press "To File", the analyzer brings up a Windows dialog and a menu entitled "Save As." This menu allows you to navigate to the various fields in the Windows dialog without using a keyboard or mouse. The Tab and Arrow keys can also be used for dialog navigation.

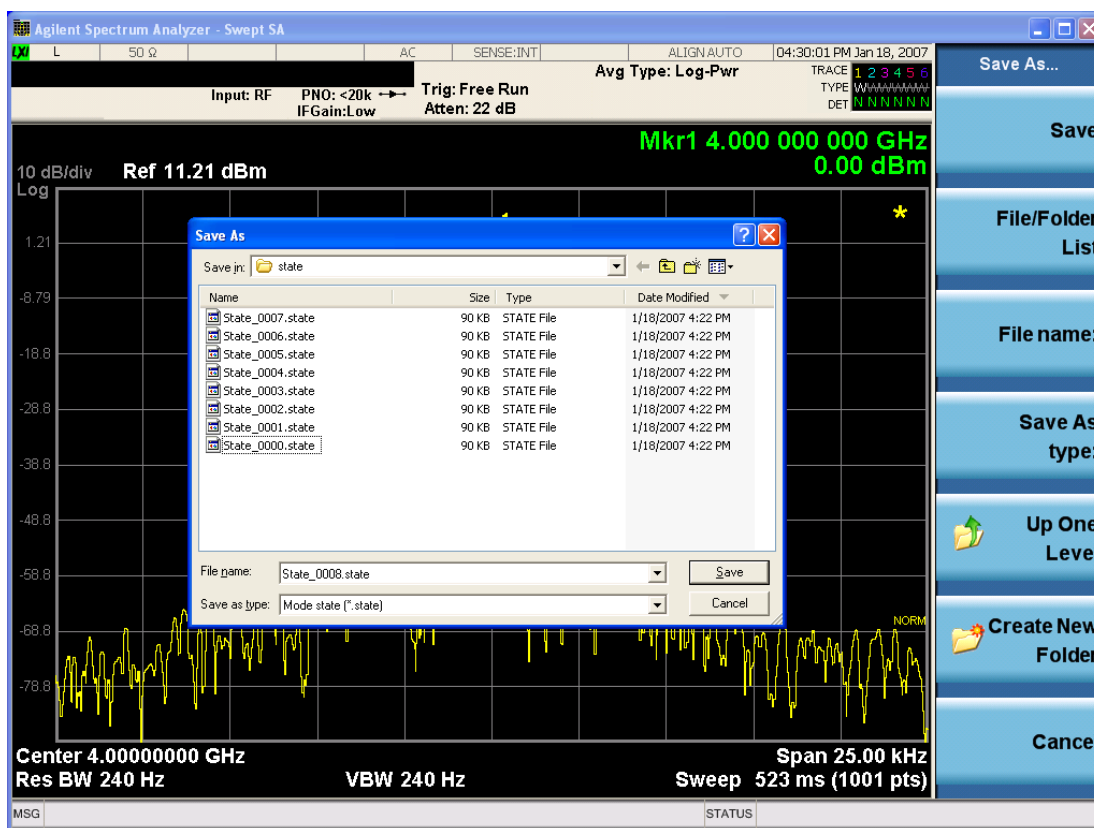

The Listed below

are the functions of the various fields in the dialog, and the corresponding softkeys:

Save

Performs the save to the specified file of the selected type. If the file already exists, a dialog will appear that allows you to replace the existing file by selecting OK, or you can Cancel the request. If you select OK,

the file will be overwritten. Using the C: drive is strongly discouraged, since it runs the risk of being overwritten during an instrument software upgrade.

While the save is being performed, the floppy icon appears briefly in the Meas bar.

File/Folder List

Enables you to navigate to the center of the dialog that contains the list of files and folders. Once here you can get information about the file and use the tab keys to navigate to the other fields in the dialog, such as Save In.

Save In

The Save In field shows the path to which the file will be saved and allows you to change the path using the up and down arrow keys to navigate to other paths; the Enter key to open a directory; and the Backspace key to go back one directory. The **Save In field** defaults to the default path for this type of file and remembers the last path you used to save this type of file. There is no softkey for directly navigating to the Save In field but you can use left tab to get here from the File/Folder List.

User specified paths are remembered when you leave and return to a Mode and are reset back to the default using Restore Mode Defaults.

File Name

The File Name field is initially loaded with an automatically generated filename specific to the appropriate Save Type. The automatically generated filename is guaranteed not to conflict with any filename currently in the directory. You may replace or modify this filename using the File Name key. See the ["Quick Save " on page 2056](#) documentation for more on the automatic file naming algorithm.

When you press the File Name key the analyzer displays the Alpha Editor. Use the knob to choose the letter to add and the front-panel Enter key to add the letter to the file name. The BK character moves you back and the FW character moves you forward in the filename. The Select key on the front panel generates a space character. When you are done entering the filename press the Done softkey. This returns back to the **File Open** dialog and menu, but does not cause the save to occur.

Save As Type

This field shows the file suffix for the type of file you have selected to save. For example, if you navigated here while saving State, "Mode state (*.state)" is in the field. If you navigated here from saving Trace, ""Mode state (*.trace)" is in the field. If you navigated here while exporting a trace data file, "Trace Data (*.csv)" is in the field. For some file types, there is more than one choice in the dropdown, which you can select by using the up and down arrow keys and Enter.

Up One Level

This key corresponds to the icon of a folder with the up arrow that is in the tool bar of the dialog. When pressed, it causes the file and folder list to navigate up one level in the directory structure. The Backspace key does the same thing.

Create New Folder

This key corresponds to the icon of a folder with the "*" that is in the tool bar of the dialog. When pressed, a new folder is created in the current directory with the name **New Folder** and you can enter a new folder name using the Alpha Editor.

Cancel

This key corresponds to the Cancel selection in the dialog. It causes the current **Save As** request to be cancelled. The ESC key does the same thing.

Key Path	Save, State
Mode	All
Notes	Brings up Save As dialog for saving a State Save Type
Initial S/W Revision	Prior to A.02.00

Edit Register Names

You may enter a custom name on any of the Register keys, to help you remember what you are using that state to save. To do this, press the Edit Register Names key, choose the register whose name you wish to edit, and then enter the desired label using the Alpha Editor or an external PC keyboard.

The maximum number of characters that can be added is 30. In most cases, 30 characters will fit on two lines of the key.

See ["More Information" on page 1307](#)

Key Path	Save, State
Mode	All
Remote Command	:MMEMory:REGister:STATe:LABel <reg number>,"label" :MMEMory:REGister:STATe:LABel? <reg number>
Example	:MMEM:REG:STAT:LAB 1,"my label"
Notes	<reg number> is an integer from 1 to 16. If the SCPI specifies an invalid register number an error message is generated, -222,"Data out of range;Invalid register label number" "label" is a string from 0 to 30 characters in length. If a label exceeds 30 characters, an error message is generated, -150,"String data error;Label clipped to 30 characters" "label" of length 0 erases the custom label and restores the default (time and date) label. E.g.: :MMEM:REG:STAT:LAB 1,""
Dependencies	N9060A-7FP or N9060B-2FP license required to edit the register names. When the feature is not licensed, sending this command generates an error, -221,"Settings conflict;Option not available"
Preset	The names are unaffected by Preset or power cycle but are set to the default label (time and date) on a "Restore System Defaults->Misc"
Initial S/W Revision	A.11.00

More Information

When you edit one of the register names, the time and date field will be replaced by the custom name.

If you delete all the characters in the custom name, it restores the default (time and date).

The register names are stored within the state files, but they are not part of the instrument state; that is, once you have edited a register name, loading a new state will not change that register name. Another

consequence of this is that the names will be persistent through a power cycle. Also, if a named state file is transferred to another analyzer, it will bring its custom name along with it.

If you try to edit the name of an empty register, the analyzer will first save the state to have a file to put the name in. If you load a named state file into an analyzer with older firmware it will ignore the metadata.

The *SAV and *RCL commands will not be affected by the custom register names, nor will the MMEM commands.

Register 1 thru Register 16

Selecting any one of these register menu keys causes the State of the currently active mode to be saved to the specified Register. The registers are provided for rapid saving and recalling, since you do not need to specify a filename or navigate to a file. Each of the register menu keys annotates whether it is empty or at what date and time it was last modified. In addition, you can use the Edit Register Names key to enter custom names for each register.

NOTE

In products that run multiple instances of the X-Series Application, save with different register name if you do not want to overwrite the register of another running instance.

Although these 16 registers are the only registers available from the front panel, there are 128 state registers available in the instrument. Registers 17–128 are only available from the SCPI interface, using the *SAV command.

There is one set of 128 state registers in the instrument, not one set for each Mode. When a state is saved, the Mode it was saved from is saved with it; then when it is recalled, the instrument switches to that Mode.

After the save completes, the corresponding register menu key annotation is updated with the date and time and the message "Register <register number> saved" is displayed.

Key Path	Save, State
Mode	All
Example	*SAV 1
Range	1–16 from front panel, 1–128 from SCPI
Readback	Date and time with seconds resolution are displayed on the key OR A custom name of up to 30 characters entered using the Edit Register Names key OR “(empty)” if no prior save operation has been performed to this register.
Initial S/W Revision	Prior to A.02.00
Modified at S/W Revision	A.11.00

Register 1 thru Register 16

Selecting any one of these register menu keys causes the State of the currently active mode to be saved to the specified Register. The registers are provided for rapid saving and recalling, since you do not need to specify a filename or navigate to a file. Each of the register menu keys annotates whether it is empty or at

what date and time it was last modified. In addition, you can use the Edit Register Names key to enter custom names for each register.

NOTE In products that run multiple instances of the X-Series Application, save with different register name if you do not want to overwrite the register of another running instance.

Although these 16 registers are the only registers available from the front panel, there are 128 state registers available in the instrument. Registers 17–128 are only available from the SCPI interface, using the *SAV command.

There is one set of 128 state registers in the instrument, not one set for each Mode. When a state is saved, the Mode it was saved from is saved with it; then when it is recalled, the instrument switches to that Mode.

After the save completes, the corresponding register menu key annotation is updated with the date and time and the message "Register <register number> saved" is displayed.

Key Path	Save, State
Mode	All
Example	*SAV 1
Range	1–16 from front panel, 1–128 from SCPI
Readback	Date and time with seconds resolution are displayed on the key OR A custom name of up to 30 characters entered using the Edit Register Names key OR “(empty)” if no prior save operation has been performed to this register.
Initial S/W Revision	Prior to A.02.00
Modified at S/W Revision	A.11.00

Mass Storage Catalog (Remote Command Only)

Key path	SCPI Only
Remote Command	:MMEMory:CATalog? [<directory_name>]
Notes	The string must be a valid logical path. Queries disk usage information (drive capacity, free space available) and obtains a list of files and directories in a specified directory in the following format: <numeric_value>,<numeric_value>,{<file_entry>} It returns two numeric parameters and as many strings as there are files and directories. The first parameter indicates the total amount of storage currently used in bytes. The second parameter indicates the total amount of storage available, also in bytes. The <file_entry> is a string. Each <file_entry> indicates the name, type, and size of one file in the directory list: <file_name>,<file_type>,<file_size> As the windows file system has an extension that indicates file type, <file_type> is always empty. <file_size> provides the size of the file in bytes. For directories, <file_entry> is surrounded by square brackets and both <file_type> and <file_size> are empty
Initial S/W Revision	Prior to A.02.00

Mass Storage Change Directory (Remote Command Only)

Key path	SCPI Only
Remote Command	:MMEMory:CDIRectory [<directory_name>] :MMEMory:CDIRectory?
Notes	The string must be a valid logical path. Changes the default directory for a mass memory file system. The <directory_name> parameter is a string. If no parameter is specified, the directory is set to the *RST value. At *RST, this value is set to the default user data storage area, that is defined as System.Environment.SpecialFolder.Personal. Query returns full path of the default directory.
Initial S/W Revision	Prior to A.02.00

Mass Storage Copy (Remote Command Only)

Key path	SCPI Only
Remote Command	:MMEMory:COPY <string>,<string>[,<string>,<string>]
Notes	The string must be a valid logical path. Copies an existing file to a new file or an existing directory to a new directory. Two forms of parameters are allowed. The first form has two parameters. In this form, the first parameter specifies the source, and the second parameter specifies the destination. The second form has four parameters. In this form, the first and third parameters specify the source. The second and fourth parameters specify the directories. The first pair of parameters specifies the source. The second pair specifies the destination. An error is generated if the source doesn't exist or the destination file already exists. This command will generate an "access denied" error if the destination is a restricted folder (e.g., C:\Windows) and the current user does not have Power User or Administrator privileges.

Mass Storage Device Copy (Remote Command Only)

This command transfers data to/from a file and a peripheral device.

Key path	SCPI Only
Remote Command	:MMEMory:COPY:DEvice <source_string>,<dest_string>
Notes	The strings must be a valid logical path or a valid device keyword. If the dest_string is a device keyword, the data is copied from the source file to the device. If the source_string is a device keyword, the data is copied to the source file from the device. Valid device keywords are: SNS (smart noise source) An error is generated if the file or device is not found.

Mass Storage Delete (Remote Command Only)

Key path	SCPI Only
Remote Command	:MMEMory:DELeTe <file_name>[,<directory_name>]
Notes	The string must be a valid logical path. Removes a file from the specified directory. The <file_name> parameter specifies the file name to be removed. This command will generate an “access denied” error if the file is in a restricted folder (e.g., C:\Windows) and the current user does not have Power User or Administrator privileges.
Initial S/W Revision	Prior to A.02.00

Mass Storage Data (Remote Command Only)

Creates a file containing the specified data OR queries the data from an existing file.

Key path	SCPI Only
Remote Command	:MMEMory:DATA <file_name>, <data> :MMEMory:DATA? <file_name>
Notes	The string must be a valid logical path. The command form is MMEMory:DATA <file_name>,<data>. It loads <data> into the file <file_name>. <data> is in 488.2 block format. <file_name> is string data. The query form is MMEMory:DATA? <file_name> with the response being the associated <data> in block format.
Initial S/W Revision	Prior to A.02.00

Mass Storage Make Directory (Remote Command Only)

Key path	SCPI Only
Remote Command	:MMEMory:MDIRectory <directory_name>
Notes	The string must be a valid logical path. Creates a new directory. The <directory_name> parameter specifies the name to be created. This command will generate an “access denied” error if the new directory would be in a restricted folder (e.g., C:\Windows) and the current user does not have Power User or Administrator privileges.
Initial S/W Revision	Prior to A.02.00

Mass Storage Move (Remote Command Only)

Key path	SCPI Only
Remote Command	:MMEMory:MOVE <string>,<string>[,<string>,<string>]
Notes	The string must be a valid logical path. Moves an existing file to a new file or an existing directory to a new directory.

Two forms of parameters are allowed. The first form has two parameters. In this form, the first parameter specifies the source, and the second parameter specifies the destination.

The second form has four parameters. In this form, the first and third parameters specify the source. The second and fourth parameters specify the directories. The first pair of parameters specifies the source. The second pair specifies the destination. An error is generated if the source doesn't exist or the destination file already exists.

This command will generate an "access denied" error if the destination is a restricted folder (e.g., C:\Windows) and the current user does not have Power User or Administrator privileges.

Initial S/W Revision Prior to A.02.00

Mass Storage Remove Directory (Remote Command Only)

Key path SCPI Only

Remote Command :MMEMory:RDIRECTory <directory_name>

Notes

The string must be a valid logical path.

Removes a directory. The <directory_name> parameter specifies the directory name to be removed. All files and directories under the specified directory shall also be removed.

This command will generate an "access denied" error if the folder is a restricted folder (e.g., C:\Windows) or is in a restricted folder and the current user does not have Power User or Administrator privileges.

Initial S/W Revision Prior to A.02.00

Mass Storage Determine Removable Media (Remote Command Only)

This command is used to determine if any removable media devices are connected to the instrument. Primarily, these are USB memory devices plugged-in to the front panel or rear panel USB ports. On instruments with PC6 or PC7 CPU's, one SD card slot is available for removable media. The instrument's primary disk drive is not a removable media device.

Key Path SCPI Only

Remote Command :MMEMory:RMEDIA:LIST?

Notes

The return value will be a string containing a list of partition identifiers which are removable media devices. Each identifier will be separated by a comma. If no removable media is present, an empty string will be returned.

Examples:

One removable device present will result in a return string of "F:".

Two removable devices present will result in a return string of "F:,G:".

No removable devices present will result in a return string of "".

Initial S/W Revision x.15.00

Mass Storage Determine Removable Media Label (Remote Command Only)

This command is used to set or query a removable media device's label.

Key Path	SCPI Only
Remote Command	:MMEMory:RMEDia:LABel <partition>,<string> :MMEMory:RMEDia:LABel? <partition>
Example	MMEM:RMED:LAB "F:","My Device"
Notes	If the <partition> specified does not exist or is not a removable media device the error -252,"Missing Media" will be generated. Setting the removable media label requires Administrative privileges. If the currently logged in user does not have appropriate privileges the error "-221.9900,Settings conflict;Administrator privileges required" is generated.
Initial S/W Revision	x.15.00

Mass Storage Determine Removable Media Write-protect status (Remote Command Only)

This command is used to query a removable media device's write-protect status.

Key Path	SCPI Only
Remote Command	:MMEMory:RMEDia:WPRotect? <partition>
Example	MMEM:RMED:WPR? "F:"
Notes	The return value is 1 if the device is write-protected, and 0 if the device is write-enabled. If the <partition> specified does not exist or is not a removable media device the error -252,"Missing Media" will be generated.
Preset	The return value will be depending on SD card installed.
Initial S/W Revision	x.15.00

Mass Storage Determine Removable Media size (Remote Command Only)

This command is used to query a removable media device's total memory size (not available memory size).

Key Path	SCPI Only
Remote Command	:MMEMory:RMEDia:SIZE? <partition>
Example	MMEM:RMED:SIZE? "F:"
Notes	The return value is integer value in GBytes. Any device which is less than 1 GB will return 0 GB. If the <partition> specified does not exist or is not a removable media device the error -252,"Missing Media" will be generated.
Initial S/W Revision	x.15.00

Sequences

These keys allow you to save a Tab separated or CSV file of the setup parameters required to build a Sequence.

In order to save you must select the Save As button and choose a destination folder.

Key Path	Save, Sequences
Mode	All
Remote Command	:MMEM:STOR:SEQ:Sequences: SLIST ALIST SAAList SSTep "MySequence.txt"
Example	:MMEM:STOR:SEQ:SLIST "MySequence.txt"
Notes	Available file types are: –CSV (Comma delimited) (*.csv) –Text (Tab delimited) (*.txt)
Initial S/W Revision	A.05.00

Source Sequence

The list of parameters, that configure steps, that makes up a sequence for the Source.

The Source sequence is a sequence of flexible configurable steps that can be set anywhere in the instruments frequency range.

Key Path	Save, Sequences
Example	:MMEM:STOR:SEQ:SLIS "MySequence.txt"
Dependencies	Only available in XOBT
Initial S/W Revision	A.05.00

Save As . . .

This menu lets you select the location where you can save the Sequence. This menu is a standard Windows® dialog with Save As menu keys. The "File Name" field in the Save As dialog is initially loaded with an automatically generated filename specific to the appropriate Save Type. The automatically generated filename is guaranteed not to conflict with any filename currently in the directory. You may replace or modify this filename using the File Name softkey. See the Quick Save key documentation for more on the automatic file naming algorithm.

The default path for all Sequence Files is:

My Documents\Sequences

Key Path	Save, Sequences
Mode	All

Notes	Brings up Save As dialog for saving a Sequence Save Type
Initial S/W Revision	A.05.00

Data (Export)

Exporting a data file stores data from the current measurement to mass storage files. The Export Menu only contains data types that are supported by the current measurement.

Since the commonly exported data files are in .csv format, the data can be edited by you prior to importing. This allows you to export a data file, manipulate the data in Excel (the most common PC Application for manipulating .csv files) and then import it.

Selecting an Export Data menu key will not actually cause the exporting to occur, since the analyzer still needs to know where you wish to save the data. Pressing the Save As key in this menu brings up the Save As dialog and Save As menu that allows you to specify the destination file and directory. Once a filename has been selected or entered in the Open menu, the export will occur as soon as the Save key is pressed.

Key Path	Save
Mode	All
Notes	The menu is built from whatever data types are available for the mode. So the key locations in the sub menu will vary. No SCPI command directly controls the Data Type that this key controls. The Data Type is included in the MMEM:STORe commands.
Dependencies	If a file type is not used by a certain measurement, that type is grayed out for that measurement. The key for a file type will not show at all if there are no measurements in the Mode that support it.
Preset	Is not affected by a Preset or shutdown, but is reset during Restore Mode Defaults
Readback	The data type that is currently selected
Initial S/W Revision	Prior to A.02.00

Measurement Results

Pressing this key selects Meas Results as the data type to be exported.

The Meas Results file contains measurement result sets, plus information describing the current state of the analyzer, as detailed in "[Meas Results File Definition](#)" on page 1316 and "[Meas Results File Example](#)" on page 1317 below.

Key Path	Save, Data
Remote Command	:MMEMory:STORe:RESults <string>
Example	:MMEM:STOR:RES "MeasR_0000.csv"
Notes	If the save is initiated via SCPI and the file already exists, the file will be overwritten. The SCPI command exports Occupied Bandwidth measurement results to the file specified as the parameter in the current path. The default path is My Documents\<current mode>\data\OBW\results.

	Using the C: drive is strongly discouraged, since it runs the risk of being overwritten during an instrument software upgrade. The SCPI parameter is a quoted string that specifies the filename. Both single and double quotes are supported for any filename parameter over SCPI.
Dependencies	The current active measurement must be the Occupied Bandwidth measurement to use this command.
Status Bits/OPC dependencies	Sequential – waits for the previous measurement to complete
Initial S/W Revision	Prior to A.02.00

Meas Results File Definition

The content of a Meas Results File is defined in this section.

The first lines in the file consist of identification and instrument configuration details, as follows.

- File ID string, which is “MeasResult”
- Measurement ID following Mode ID, which is “SA:OBW” for example.
- Firmware rev and model number
- Option string
- Auto Sweep Time Rules
- Average Mode
- Average Number
- Average State
- Center Frequency
- Detector
- Electrical Atten
- Electrical Atten State
- IFGain
- IFGainAuto
- Internal Preamp
- Internal Preamp Band
- Limit
- Limit State
- Max Hold
- Mechanical Atten

- MechanicalAttenStepEnum
- OBW Percent Pwr
- Resolution Band Width
- Resolution Bandwidth Shape
- Span
- Sweep Points
- Sweep Time
- Sweep Time Auto
- TriggerSource
- Video Bandwidth
- x DB

The data above is followed in the file by a line containing “MeasResult1” and “MeasResult2”. This line forms a header for each set of measurement results, which appear in subsequent lines. Each line of Measurement Results consists of two comma-separated values, for MeasResult1 and MeasResult2 respectively.

The MeasResult1 set in the file corresponds to the data returned by MEAS|READ|FETCh:OBWidth1, and the MeasResult2 set corresponds to the data returned by MEAS|READ|FETCh:OBWidth2.

The exported file is in CSV format, with a .csv extension.

Meas Results File Example

When imported into Microsoft Excel, a typical Meas Results CSV file appears as shown in the example below.

MeasResult	
SA:OBW	
A.10.53	N9030A
526 ALV ATP B1X B1Y B25 B40 BBA CR3 CRP DCF DDA DP2 DRD EA3 EDP EMC EP1 ERC ESC ESP EXM FSA LFE LNP MAT MPB NFE NUL P26 PFR PNC RTL RTS S40 SB1 SEC SM1 TVT YAS YAV	1
Auto Sweep Time Rules	Normal
Average Mode	Exponential
Average Number	10
Average State	TRUE
Center Frequency	1.33E+10
Detector	Average
IFGain	FALSE

IFGainAuto	FALSE
Internal Preamp	FALSE
Internal Preamp Band	Low
Limit	5000000
Limit State	FALSE
Max Hold	FALSE
OBW Percent Pwr	99
Resolution Band Width	27000
Resolution Bandwidth Shape	Gaussian
Span	3000000
Sweep Points	1001
Sweep Time	0.004933
Sweep Time Auto	TRUE
TriggerSource	Free
Video Bandwidth	270000
x DB	-26
MeasResult1	MeasResult2
2971020.10835045	-94.3702543927405
-74.9741251886604	-94.1447790390963

Capture Buffer

This function allows you to store captured data for reuse in demod measurements using 'Save/Recall' functionality for 'Capture Buffer'.(This function is enabled for 'Code Domain' and 'Modulation Accuracy' measurements ONLY)

'Cature Buffer' is saved and loaded as IQ Data with properties which show Sample Rate, Length, IF BW, etc.

Use-Case are as followings;

Use Capture Buffer to perform analysis of the same captured data using 'Code Domain' and 'Modulation Accuracy' measurements, or to playback previously saved captured data.

Key Path	Save, Data
Mode	CDMA2000
Example	MMEM:STOR:CAPT "MyCaptureData.bin" This stores the capture data in the file MyCaptureData.bin in the default directory.
Dependencies	Capture buffer functionality is only available for Code Domain and Modulation Accuracy measurement. In other measurements, this key is grayed out.
Initial S/W Revision	Prior to A.02.00

Save As . . .

When you press “Save As”, the analyzer brings up a Windows dialog and a menu entitled “**Save As.**” This menu allows you to navigate to the various fields in the Windows dialog without using a keyboard or mouse. The Tab and Arrow keys can also be used for dialog navigation.

See ["To File . . ." on page 2070](#) in Save, State for a full description of this dialog and menu.

The default path for saving files is:

For all of the Trace Data Files:

My Documents\`<mode name>`\data\traces

For all of the Limit Data Files:

My Documents\`<mode name>`\data\limits

For all of the Measurement Results Data Files:

My Documents\`<mode name>`\data\`<measurement name>`\results

For all of the Capture Buffer Data Files:

My Documents\`<mode name>`\data\captureBuffer

Key Path	Save, Data
Mode	All
Notes	The key location is mode-dependent and will vary. Brings up the Save As dialog for saving a <code><mode specific></code> Save Type. The save is performed immediately and does not wait until the measurement is complete.
Initial S/W Revision	Prior to A.02.00

Screen Image

Pressing Screen Image accesses a menu of functions that enable you to specify a format and location for the saved screen image. It brings up a menu that allows you to specify the color scheme of the Screen Image (Themes) or navigate to the Save As dialog to perform the actual save.

Screen Image files contain an exact representation of the analyzer display. They cannot be loaded back onto the analyzer, but they can be loaded into your PC for use in many popular applications.

The image to be saved is actually captured when the Save front panel key is pressed, and kept in temporary storage to be used if you ask for a Screen Image save. When the Screen Image key is pressed, a "thumbnail" of the captured image is displayed, as shown below:

11 Occupied Bandwidth Measurement

Save

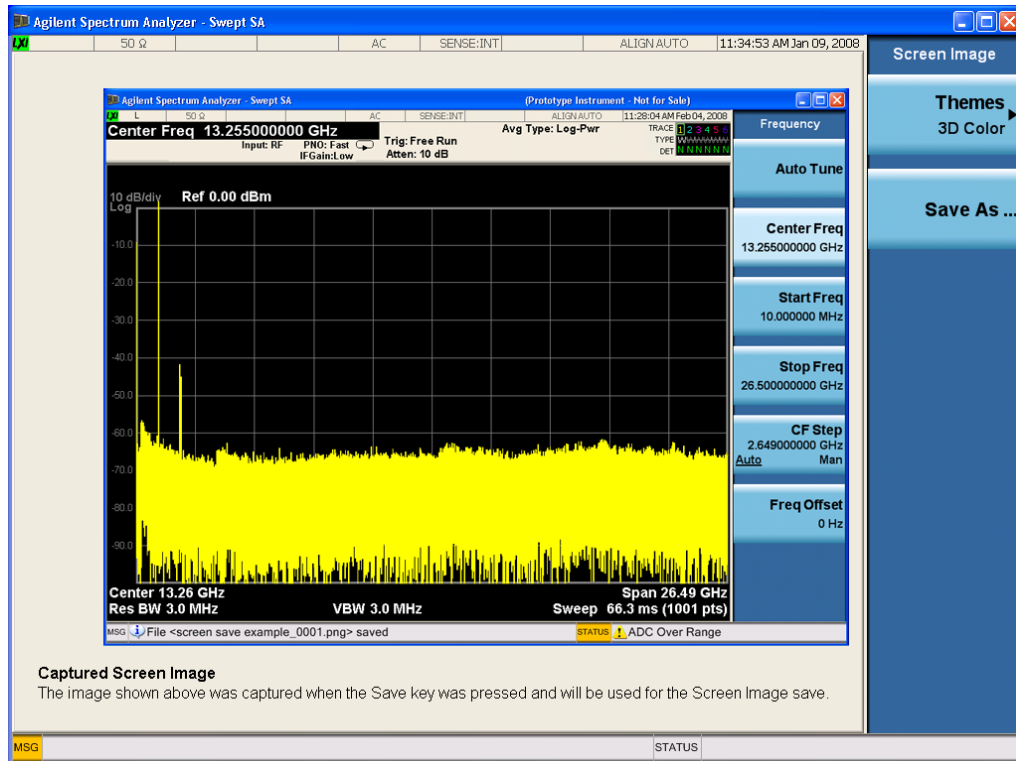

When you continue on into the Save As menu and complete the Screen Image save, the image depicted in the thumbnail is the one that gets saved, showing the menus that were on the screen before going into the Save menus. The save is performed immediately and does not wait until the measurement is complete.

After you have completed the save, the Quick Save front-panel key lets you quickly repeat the last save performed, using an auto-named file, with the current screen data.

NOTE

For versions previous to A.01.55, if you initiate a screen image save by navigating through the Save menus, the image that is saved will contain the Save menu softkeys, not the menus and the active function that were on the screen when you first pressed the Save front panel key.

Key Path	Save
Mode	All
Remote Command	:MMEMory:STORe:SCReen <filename>
Example	:MMEM:STOR:SCR "myScreen.png" This stores the current screen image in the file MyScreenFile.png in the default directory.
Initial S/W Revision	Prior to A.02.00

Themes

Accesses a menu of functions that enable you to choose the theme to be used when saving the screen image.

The **Themes** option is the same as the **Themes** option under the **Display** and **Page Setup** dialogs. It allows you to choose between themes to be used when saving the screen image.

Key Path	Save, Screen Image
Remote Command	:MMEMory:STORe:SCReen:THEMe TDColor TDMonochrome FCOLOR FMONochrome :MMEMory:STORe:SCReen:THEMe?
Example	:MMEM:STOR:SCR:THEM TDM
Preset	3D Color; Is not part of Preset, but is reset by Restore Misc Defaults or Restore System Defaults All and survives subsequent running of the modes.
Readback	3D Color 3D Mono Flat Color Flat Mono
Backwards Compatibility Notes	In ESA and PSA we offer the choice of "Reverse Bitmap" or "Reverse Metafile" when saving screen images. This is much like the "Flat Color" theme available in X-Series. Also, if you selected Reverse Bitmap AND a black & white screen image, that would be much like "Flat Monochrome". In other words, each of the X-Series themes has a similar screen image type in ESA/PSA. But they are not identical.
Initial S/W Revision	Prior to A.02.00

3D Color

Selects a standard color theme with each object filled, shaded and colored as designed.

Key Path	Save, Screen Image, Themes
Example	MMEM:STOR:SCR:THEM TDC
Readback	3D Color
Initial S/W Revision	Prior to A.02.00

3D Monochrome

Selects a format that is like 3D color but shades of gray are used instead of colors.

Key Path	Save, Screen Image, Themes
Example	MMEM:STOR:SCR:THEM TDM
Readback	3D Mono
Initial S/W Revision	Prior to A.02.00

Flat Color

Selects a format that is best when the screen is to be printed on an ink printer.

Key Path	Save, Screen Image, Themes
----------	----------------------------

Example	MMEM:STOR:SCR:THEM FCOL
Readback	Flat Color
Initial S/W Revision	Prior to A.02.00

Flat Monochrome

Selects a format that is like Flat Color. But only black is used (no colors, not even gray), and no fill.

Key Path	Save, Screen Image, Themes
Example	MMEM:STOR:SCR:THEM FMON
Readback	Flat Mono
Initial S/W Revision	Prior to A.02.00

Save As...

When you press "Save As", the analyzer brings up a Windows dialog and a menu entitled "**Save As.**" This menu allows you to navigate to the various fields in the Windows dialog without using a keyboard or mouse. The Tab and Arrow keys can also be used for dialog navigation.

See "[To File . . .](#)" on page 2070 in Save, State for a full description of this dialog and menu.

The default path for Screen Images is

My Documents\`<mode name>`\screen.

where `<mode name>` is the parameter used to select the mode with the INST:SEL command (for example, SA for the Spectrum Analyzer).

Key Path	Save, Screen Image
Notes	Brings up Save As dialog for saving a Screen Image Save Type
Initial S/W Revision	Prior to A.02.00

Single (Single Measurement/Sweep)

Sets the analyzer for Single measurement operation. The single/continuous state is Meas Global, so the setting will affect all the measurements. If you are Paused, pressing Single does a Resume.

See ["More Information" on page 1323](#)

Key Path	Front-panel key
Example	:INIT:CONT OFF
Notes	See Cont key description.
Backwards Compatibility Notes	<p>For Spectrum Analysis mode in ESA and PSA, the Single hardkey and the INITiate:IMM switched from continuous measurement to single measurement and restarted sweeps and averages (displayed average count reset to 1), but did not restart Max Hold and Min Hold. In the X-Series, the Single hardkey and the INITiate:IMM command initiate a sweep/ measurement/ average sequence/hold sequence including MaxHold and MinHold.</p> <p>For Spectrum Analysis mode in ESA and PSA, the Single hardkey restarted the sweep regardless of whether or not you were in an active sweep or sweep sequence. In the X-Series, Restart does this but Single only restarts the sweep or sweep sequence if you are in the idle state.</p> <p>INIT[:IMM] in ESA & PSA Spectrum Analysis Mode does an implied ABORT. In some other PSA Modes, INIT[:IMM] is ignored if not in the idle state. . The X-Series follows the ESA/PSA SA Mode model, which may cause some Modes to have compatibility problems.</p>
Initial S/W Revision	Prior to A.02.00

More Information

See ["Restart" on page 2067](#) for details on the INIT:IMMEDIATE (Restart) function.

If you are already in single sweep, the INIT:CONT OFF command has no effect.

If you are already in Single Sweep, then pressing the Single key in the middle of a sweep does not restart the sweep or sequence. Similarly, pressing the Single key does not restart the sweep or sequence if the sweep is not in the idle state (for example, if you are taking a very slow sweep, or the analyzer is waiting for a trigger). Instead, it results in a message. "Already in Single, press Restart to initiate a new sweep or sequence". Even though pressing the Single key in the middle of a sweep does not restart the sweep, sending INIT:IMMEDIATE does reset it.

To take one more sweep without resetting the average count, increment the average count by 1, by pressing the step up key while **Average/Hold Number** is the active function, or sending the remote command CALC:AVER:TCON UP.

Source

Opens a menu of keys that access various source configuration menus and settings. In the test set, pressing this key also causes the central view area to change and display the Source Control Main view.

Key Path	Front-panel key
----------	-----------------

RF Output

This parameter sets the source RF power output state.

Key Path	Source
Remote Command	:OUTPut[:EXTErnal][:STATe] ON OFF 1 0 :OUTPut[:EXTErnal][:STATe]?
Example	OUTP OFF OUTP?
Notes	<p>The EXTErnal node is shown in RD text so the SCPI remains the same between internal and external source control. However, for EXT we do not wish to document this node to the customer since we are controlling the internal source rather than the external source.</p> <p>This setting is for the independent mode and has no effect on the "List Sequencer" on page 2168. If the "Sequencer" on page 2168 is set to ON, the list sequencer controls the source output and this key will be grayed-out. And this setting will be none-forceful grey out on front panel to indicate out-of-scope. Non-forceful means user still can change this setting by SCPI but cannot change on front panel. When set to OFF will make source leave list sequencer and this setting will be black out and take effect immediately.</p> <p>When the RF Output is ON, an "RF" annunciator is displayed in the system settings panel. When the RF Output is turned Off, the RF annunciator is cleared. If the "Sequencer" on page 2168 is set to ON, the "RF" annunciator will be replaced by "SEQ" in the system settings panel, indicating that the output is controlled by the list sequencer.</p>
Preset	Off
Range	On Off
Initial S/W Revision	A.05.00

Amplitude

Allows you to access the Amplitude sub-menu.

Key Path	Source
Notes	<p>The sub-menu under this button is for independent mode and has no effect on "List Sequencer" on page 2168. If the "Sequencer" on page 2168 is set to ON, the list sequencer controls the source output and this key will be grayed-out on front panel to indicate out-of-scope. When you set "Sequencer" on page 2168 to Off will make source leave list sequencer and this button will be black out.</p>
Initial S/W Revision	A.05.00

RF Power

Allows you to adjust the power level of the source using the numeric keypad, step keys, or RPG. Pressing any digit, 0 through 9, on the numeric keypad brings up the unit terminator.

Please refer to the ["RF Power Range " on page 1326](#) table below for the valid ranges.

Key Path	Source, Amplitude
Remote Command	:SOURce:POWer[:LEVel][:IMMediate][:AMPLitude] <ampl> :SOURce:POWer[:LEVel][:IMMediate][:AMPLitude]?
Example	:SOUR:POW -100 dBm
Notes	<p>Amplitude corrections can be specified for use with the source. In the event of amplitude corrections being applied, the valid ranges for the RF power do not change dependant on the current amplitude correction setting. If the combination of RF power + amplitude correction is higher or lower than the source output range, the Source Unleveled bit is set and the "Source Unleveled" indicator will appear on status panel to indicate that the source cannot maintain the output power that has been requested.</p> <p>When signal generator is unable to maintain the requested output level, the "Source Unleveled" indicator will appear on status panel. When the source output setting is restored to the normal range, the "Source Unleveled" is removed from status panel.</p> <p>Internal source has list sequence mode, which comprises of several steps which contain separate output power, frequency and waveform etc. When the source list sequence playing is complete, the last step keeps playing, and user can use this command to change the list sequence last step's output power.</p> <p>The multiport adapter RFIO TX ports and GPS ports cannot ensure power accuracy when power setting is lower than -130dBm, this power setting value is defined by the sum of RF Power setting and related amplitude correction value. But user settable value could be lower than this limit. When application detected there exists power setting lower than -130dBm on MPA RFIO TX ports, then popup warning message . When application detected there exists power setting lower than -130dBm on MPA GPS ports, then popup warning message . This is only warning message, and check is performed when RF is ON.</p>
Notes	The Min and Max value here defined UI settable amplitude range. This range is larger than actual amplitude range with level accuracy defined in spec.
Dependencies	The RF power is dependent on the RF output port and frequency, such that the current frequency and selected output port determine the valid range of power values.
Preset	-100 dBm
Min	The range of values depends on the current frequency and selected RF output port. Please refer to the "RF Power Range " on page 1326 table below for the valid ranges.
Max	The range of values depends on the current frequency and selected RF output port. Please refer to the "RF Power Range " on page 1326 table below for the valid ranges.
Initial S/W Revision	A.05.00

All other models:

RF Power Range

RF Output Port	Frequency Range	Min Output Power	Max Output Power
High Power RF Out	10 MHz ≤ f ≤ 6 GHz	-150 dBm	20 dBm
RFIO 1 & RFIO 2	10 MHz ≤ f ≤ 6 GHz	-150 dBm	0 dBm
GPS (Note2)	10 MHz ≤ f ≤ 6 GHz	-150 dBm	0 dBm

Note: This is the UI power range, it's larger than actual spec.

Note2: GPS port is on the multiport adapter, or E6607C which has embedded MPA.

M9420A:

RF Power Range

RF Output Port	Frequency Range	Min Output Power	Max Output Power without Option "1EA"	Max Output Power with Option "1EA"
RF Output	60 MHz ≤ f ≤ 6 GHz	-150 dBm	10 dBm	18 dBm
RFHD	60 MHz ≤ f ≤ 6 GHz	-150 dBm	10 dBm	15 dBm
RFFD	60 MHz ≤ f ≤ 6 GHz	-150 dBm	0 dBm	0 dBm

Set Reference Power

This key allows you to set the power reference. Pressing this key turns the power reference state to ON, sets the reference power value to the current RF output power, maintains this power at the RF output, and sets the displayed power to 0.00 dB. All subsequent RF power values entered under Source>Amplitude>RF Power are interpreted as being relative to this reference power.

When you use a power reference, the signal generator outputs an RF power that is set relative to the reference power by the value entered under Source>Amplitude>RF Power as follows:

Output power = reference power – entered power

Where:

reference power equals the original RF Power entered under Source>Amplitude>RF Power and set as the reference power

entered power equals a new value entered under Source>Amplitude>Amptd Offset

In addition, the displayed power value is the same as a new value entered under Source>Amplitude>RF Power.

NOTE

If Power Ref is set to ON with a reference value set, entering a value under Source>Amplitude>RF Power and pressing Set Reference Power will add that value to the existing Power Ref value.

If you wish to change the reference power value to a new value entered under Source>Amplitude>RF Power, first you must set Power Ref to OFF and then press Set Reference Power.

Key Path	Source, Amplitude
Dependencies	This key is unavailable, and is grayed out when the "List Sequencer" on page 2168 is turned ON.
Initial S/W Revision	A.05.00

Power Ref

This key allows you to toggle the state of the power reference.

When you use a power reference, the signal generator outputs an RF power that is set relative to the reference power by the value entered under Source>Amplitude>RF Power as follows:

Output power = reference power + entered power

Where:

reference power equals the original RF Power entered under Source>Amplitude>RF Power and set as the reference power

entered power equals a new value entered under Source>Amplitude>Amptd Offset

For more information on Reference Frequency refer to ["Set Reference Power " on page 2099](#)

Key Path	Source, Amplitude
Remote Command	:SOURce:POWer:REFerence <ampl> :SOURce:POWer:REFerence? :SOURce:POWer:REFerence:STATe OFF ON 0 1 :SOURce:POWer:REFerence:STATe?
Example	:SOUR:POW:REF 0.00 dBm :SOUR:POW:REF:STATe ON
Dependencies	This setting is unavailable and is grayed out when the "List Sequencer" on page 2168 is turned ON.
Couplings	This value is coupled to the "Set Reference Power " on page 2099 key such that pressing the Set Reference Power key updates the reference power with the current output power.
Preset	0.00 dBm OFF
Min	-125.00 dBm
Max	10.00 dBm
Initial S/W Revision	A.05.00

Amptd Offset

Allows you to specify the RF output power offset value.

When the amplitude offset is set to zero (0) and you set a new offset value (positive or negative), the displayed amplitude value will change as follows and the RF output power will not change:

Displayed value = output power + offset value

Where:

output power equals the original RF Power entered under Source>Amplitude>RF Power

offset value equals the value entered under Source>Amplitude>Amptd Offset

When the amplitude offset is set to a value other than zero (0) and you enter a new RF power value under Source>Amplitude>RF Power, the displayed power will be the same as the value entered and the RF output power will be equal to the value entered minus the offset value as follows:

Output power = entered power – offset power

Displayed Power = output power + offset power

Displayed power = entered power

Where:

entered power equals the amplitude entered under Source>Amplitude>RF Power

offset power equals the value previously entered and set under Source>Amplitude>Amptd Offset

Key Path	Source, Amplitude
Remote Command	:SOURce:POWer[:LEVel][:IMMediate]:OFFSet <rel_ampl> :SOURce:POWer[:LEVel][:IMMediate]:OFFSet?
Example	:SOUR:POW:OFFS 0.00 dB
Dependencies	This setting is unavailable, and is grayed out when the List Sequencer is turned ON.
Preset	0.00 dB
Min	-200.00 dB
Max	200.00 dB
Initial S/W Revision	A.05.00

Modulation

Allows you to toggle the state of the modulation.

Key Path	Source
Remote Command	:OUTPut:MODulation[:STATe] ON OFF 1 0 :OUTPut:MODulation[:STATe]?
Example	:OUTP:MOD OFF
Notes	This setting is for independent mode and has no effect on "List Sequencer" on page 2168 . If the "Sequencer" on page 2168 is set to ON, the list sequencer controls the source output and this key will be grayed-out. And this setting will be none-forceful grey out on front panel to indicate out-of-scope. Non-forceful means user still can change this setting by SCPI but cannot change manually on front panel. When set to Off will make source leave list sequencer and this setting will be black out and take effect immediately. When the Modulation is ON, the "MOD" annunciator is displayed in the system settings panel. When the Modulation is turned Off, the "MOD" annunciator is cleared. If the

"Sequencer" on page 2168 is set to ON, the "MOD" annunciator will be replaced by "SEQ" in the system settings panel indicating that the output is controlled by list sequencer.

Preset	Off
Range	On Off
Initial S/W Revision	A.05.00

Frequency

Allows you to access the Frequency sub-menu.

Key Path	Source
Notes	The sub-menu under this button is for independent mode and has no effect on "List Sequencer" on page 2168. If the "Sequencer" on page 2168 is set to ON, the list sequencer controls the source output and this key will be grayed-out. And this button will be grey out on front panel to indicate out-of-scope. When set to Off will make source leave list sequencer and this button will be black out.
Initial S/W Revision	A.05.00

Frequency

Allows you to set the RF Output Frequency. You can adjust the frequency of the source using the numeric keypad, step keys, or RPG. Pressing any digit, 0 through 9, on the numeric keypad brings up the unit terminator.

Key Path	Source, Frequency
Remote Command	:SOURce:FREQuency[:CW] <freq> :SOURce:FREQuency[:CW]?
Example	:SOUR:FREQ 1.00 GHz
Notes	Internal source has list sequence mode, which comprises of several steps which contain separate output power, frequency and waveform etc. When the source list sequence playing is complete, the last step keeps playing, and user can use this command to change the list sequence last step's output frequency.
Couplings	The frequency value is coupled to the current channel band and number, such that updates to the band and number will update the frequency value to the corresponding absolute frequency.
Preset	1.00 GHz If license F1A or 5WC is present, the default Center Frequency should be 2.412GHz.
Min	10.00 MHz
Max	Hardware Dependant: Option 503 = 3.6 GHz Option 504 = 3.8 GHz Option 506 = 6.00 GHz For E6640A, if license 5WC is present, the frequency range should be limited to: 1.1GHz-1.7GHz,

2.4GHz–2.5GHz, 4.8GHz–6.0GHz. If the user-defined frequency is outside of range, UI will report an error message called “Settings conflict; Frequency is outside available range”.

Initial S/W Revision A.05.00

Channel

The frequency of the source can be specified by a channel number of a given frequency band. This key allows you to specify the current channel number. For the appropriate range of channel numbers for a given frequency band, refer to the following tables: ["GSM/EDGE Channel Number Ranges" on page 1330](#), ["W-CDMA Channel Number Ranges" on page 1331](#), ["CDMA 2000 / 1xEVDO Channel Number Ranges" on page 1333](#), and ["LTE FDD Channel Number Ranges" on page 1335](#).

Key Path	Source, Frequency
Remote Command	:SOURCE:FREQUENCY:CHANNELS:NUMBER <int> :SOURCE:FREQUENCY:CHANNELS:NUMBER?
Example	:SOUR:FREQ:CHAN:NUMB 1
Notes	This key is grayed out when the "Radio Standard" on page 2111 is set to NONE. This key is grayed out on E6630A.
Dependencies	This key is grayed out when the "Radio Standard" on page 2111 is set to NONE. This key is grayed out on E6630A.
Couplings	The channel number is coupled to the frequency value when the "Radio Standard" on page 2111 is not set to NONE. When the frequency value is changed, the channel number will increase or decrease to match the new frequency. If the frequency is not at an exact match for a channel number, the nearest channel number is displayed along with a greater than or less than sign to indicate the frequency is above or below the channel number.
Preset	1
Min	Please refer to the tables below for the valid ranges.
Max	Please refer to the tables below for the valid ranges.
Initial S/W Revision	A.05.00

GSM/EDGE Channel Number Ranges

Band	Link (Device)	Range	Frequency (MHz)
P-GSM	Uplink (MS)	$1 \leq n \leq 124$	$890.0 + 0.2*n$
	Downlink (BS)	$1 \leq n \leq 124$	$935.0 + 0.2*n$
E-GSM	Uplink (MS)	$0 \leq n \leq 124$	$890.0 + 0.2*n$
		$975 \leq n \leq 1023$	$890.0 + 0.2*(n-1024)$
	Downlink (BS)	$0 \leq n \leq 124$	$935.0 + 0.2*n$
		$975 \leq n \leq 1023$	$935.0 + 0.2*(n-1024)$

Band	Link (Device)	Range	Frequency (MHz)
DCS 1800	Uplink (MS)	$512 \leq n \leq 885$	$1710.200 + 0.20*(n-512)$
	Downlink (BS)	$512 \leq n \leq 885$	$1805.200 + 0.20*(n-512)$
PCS 1900	Uplink (MS)	$512 \leq n \leq 810$	$1850.200 + 0.2*(n-512)$
	Downlink (BS)	$512 \leq n \leq 810$	$1930.200 + 0.2*(n-512)$
R-GSM	Uplink (MS)	$0 \leq n \leq 124$	$890.0 + 0.2*n$
		$955 \leq n \leq 1023$	$890.0 + 0.2*(n-1024)$
	Downlink (BS)	$0 \leq n \leq 124$	$935.0 + 0.2*n$
		$955 \leq n \leq 1023$	$935.0 + 0.2*(n-1024)$
GSM 450	Uplink (MS)	$256 \leq n \leq 293$	$450.6 + 0.2*(n-259)$
	Downlink (BS)	$256 \leq n \leq 293$	$460.6 + 0.2*(n-259)$
GSM 480	Uplink (MS)	$306 \leq n \leq 340$	$479.000 + 0.20*(n-306)$
	Downlink (BS)	$306 \leq n \leq 340$	$489.000 + 0.20*(n-306)$
GSM 850	Uplink (MS)	$128 \leq n \leq 251$	$824.200 + 0.20*(n-128)$
	Downlink (BS)	$128 \leq n \leq 251$	$869.200 + 0.20*(n-128)$
GSM 700	Uplink (MS)	$438 \leq n \leq 516$	$777.200 + 0.20*(n-438)$
	Downlink (BS)	$438 \leq n \leq 516$	$747.200 + 0.20*(n-438)$
T-GSM810	Uplink (MS)	$350 \leq n \leq 425$	$806.0 + 0.20*(n-350)$
	Downlink (BS)	$350 \leq n \leq 425$	$851.0 + 0.20*(n-350)$

W-CDMA Channel Number Ranges

Band	Link (Device)	Range	Frequency (MHz)
Band I	Downlink	$10562 \leq n \leq 10838$	$n \div 5$
	Uplink	$9612 \leq n \leq 9888$	$n \div 5$
Band II	Downlink	$412 \leq n \leq 687$	$n \div 5 + 1850.1$
		$9662 \leq n \leq 9938$	$n \div 5$
	Uplink	$12 \leq n \leq 287$	$n \div 5 + 1850.1$
		$350 \leq n \leq 425$	$n \div 5$
Band III	Downlink	$1162 \leq n \leq 1513$	$n \div 5 + 1575$
	Uplink	$937 \leq n \leq 1288$	$n \div 5 + 1525$
Band IV	Downlink	$537 \leq n \leq 1738$	$n \div 5 + 1805$
		$1887 \leq n \leq 2087$	$n \div 5 + 1735.1$
	Uplink	$1312 \leq n \leq 1513$	$n \div 5 + 1450$
		$1662 \leq n \leq 1862$	$n \div 5 + 1380.1$
Band V	Downlink	$1007 \leq n \leq 1087$	$n \div 5 + 670.1$
		$4357 \leq n \leq 4458$	$n \div 5$

11 Occupied Bandwidth Measurement
Source

Band	Link (Device)	Range	Frequency (MHz)
	Uplink	$782 \leq n \leq 862$	$n \div 5 + 670.1$
		$4132 \leq n \leq 4233$	$n \div 5$
Band VI	Downlink	$1037 \leq n \leq 1062$	$n \div 5 + 670.1$
		$4387 \leq n \leq 4413$	$n \div 5$
	Uplink	$812 \leq n \leq 837$	$n \div 5 + 670.1$
		$4162 \leq n \leq 4188$	$n \div 5$
Band VII	Downlink	$2237 \leq n \leq 2563$	$n \div 5 + 2175$
		$2587 \leq n \leq 2912$	$n \div 5 + 2105.1$
	Uplink	$2012 \leq n \leq 2338$	$n \div 5 + 2100$
		$2362 \leq n \leq 2687$	$n \div 5 + 2030.1$
Band VIII	Downlink	$2937 \leq n \leq 3088$	$n \div 5 + 340$
	Uplink	$2712 \leq n \leq 2863$	$n \div 5 + 340$
Band IX	Downlink	$9237 \leq n \leq 9387$	$n \div 5$
	Uplink	$8762 \leq n \leq 8912$	$n \div 5$
Band X	Downlink	$3112 \leq n \leq 3388$	$n \div 5 + 1490$
		$3412 \leq n \leq 3687$	$n \div 5 + 1430.1$
	Uplink	$2887 \leq n \leq 3163$	$n \div 5 + 1135$
		$3187 \leq n \leq 3462$	$n \div 5 + 1075.1$
Band XI	Downlink	$3712 \leq n \leq 3812$	$n \div 5 + 736$
	Uplink	$3487 \leq n \leq 3587$	$n \div 5 + 733$
Band XII	Downlink	$3837 \leq n \leq 3903$	$n \div 5 - 37$
		$3927 \leq n \leq 3992$	$n \div 5 - 54.9$
	Uplink	$3612 \leq n \leq 3678$	$n \div 5 - 22$
		$3702 \leq n \leq 3767$	$n \div 5 - 39.9$
Band XIII	Downlink	$4017 \leq n \leq 4043$	$n \div 5 - 55$
		$4067 \leq n \leq 4092$	$n \div 5 - 64.9$
	Uplink	$3792 \leq n \leq 3818$	$n \div 5 + 21$
		$3702 \leq n \leq 3767$	$n \div 5 - 39.9$
Band XIV	Downlink	$4117 \leq n \leq 4143$	$n \div 5 - 63$
		$4167 \leq n \leq 4192$	$n \div 5 - 72.9$
	Uplink	$3892 \leq n \leq 3918$	$n \div 5 + 12$
		$3942 \leq n \leq 3967$	$n \div 5 + 2.1$
Band XIX	Downlink	$712 \leq n \leq 763$	$n \div 5 + 735$
		$787 \leq n \leq 837$	$n \div 5 + 720.1$
	Uplink	$312 \leq n \leq 363$	$n \div 5 + 770$
		$387 \leq n \leq 437$	$n \div 5 + 755.1$

CDMA 2000 / 1xEVDO Channel Number Ranges

Band	Link (Device)	Range	Frequency (MHz)
US Cellular	Uplink (MS, reverse link)	$1 \leq N \leq 799$	$0.030 \times N + 825.000$
		$991 \leq N \leq 1023$	$0.030 \times (N - 1023) + 825.000$
		$1024 \leq N \leq 1323$	$0.030 \times (N - 1024) + 815.040$
	Downlink (BS, forward link)	$1 \leq N \leq 799$	$0.030 \times N + 870.000$
		$991 \leq N \leq 1023$	$0.030 \times (N - 1023) + 870.000$
		$1024 \leq N \leq 1323$	$0.030 \times (N - 1024) + 860.040$
US PCS	Uplink (MS, reverse link)	$0 \leq N \leq 1199$	$1850.000 + 0.050 \times N$
	Downlink (BS, forward link)	$0 \leq N \leq 1199$	$1930.000 + 0.050 \times N$
Japan Cellular Band	Uplink (MS, reverse link)	$1 \leq N \leq 799$	$0.0125 \times (N + 915.000)$
		$801 \leq N \leq 1039$	$0.0125 \times (N - 800) + 898.000$
		$1041 \leq N \leq 1199$	$0.0125 \times (N - 1040) + 887.000$
		$1201 \leq N \leq 1600$	$0.0125 \times (N - 1200) + 893.000$
	Downlink (BS, forward link)	$1 \leq N \leq 799$	$0.0125 \times (N + 860.000)$
		$801 \leq N \leq 1039$	$0.0125 \times (N - 800) + 843.000$
		$1041 \leq N \leq 1199$	$0.0125 \times (N - 1040) + 832.000$
		$1201 \leq N \leq 1600$	$0.0125 \times (N - 1200) + 838.000$
Korean PCS Band	Uplink (MS, reverse link)	$0 \leq N \leq 599$	$0.050 \times N + 1750.000$
	Downlink (BS, forward link)	$0 \leq N \leq 599$	$0.050 \times N + 1840.000$
NMT-450 Band	Uplink (MS, reverse link)	$1 \leq N \leq 400$	$0.025 \times (N - 1) + 450.000$
		$472 \leq N \leq 871$	$0.025 \times (N - 472) + 410.000$
		$1039 \leq N \leq 1473$	$0.020 \times (N - 1024) + 451.010$
		$1536 \leq N \leq 1715$	$0.025 \times (N - 1536) + 479.000$
		$1792 \leq N \leq 2016$	$0.020 \times (N - 1792) + 479.000$
	Downlink (BS, forward link)	$1 \leq N \leq 400$	$0.025 \times (N - 1) + 460.000$
		$472 \leq N \leq 871$	$0.025 \times (N - 472) + 420.000$
		$1039 \leq N \leq 1473$	$0.020 \times (N - 1024) + 461.010$
IMT-2000 Band	Uplink (MS, reverse link)	$0 \leq N \leq 1199$	$1920.000 + 0.050 \times N$
	Downlink (BS, forward link)	$0 \leq N \leq 1199$	$2100.000 + 0.050 \times N$
Upper 700 MHz Band	Uplink (MS, reverse link)	$0 \leq N \leq 240$	$776.000 + 0.050 \times N$
	Downlink (BS, forward link)	$0 \leq N \leq 240$	$746.000 + 0.050 \times N$

Band	Link (Device)	Range	Frequency (MHz)
	forward link)		
Secondary 800 MHz Band	Uplink (MS, reverse link)	$0 \leq N \leq 719$	$0.025 \times N + 806.000$
		$720 \leq N \leq 919$	$0.025 \times (N - 720) + 896.000$
	Downlink (BS, forward link)	$0 \leq N \leq 719$	$0.025 \times N + 851.000$
		$720 \leq N \leq 919$	$0.025 \times (N - 720) + 935.000$
2.5 GHz IMT Extension	Uplink (MS, reverse link)	$0 \leq N \leq 1399$	$2500.000 + 0.050 \times N$
	Downlink (BS, forward link)	$0 \leq N \leq 1399$	$2620.000 + 0.050 \times N$
US PCS 1.9 GHz	Uplink (MS, reverse link)	$0 \leq N \leq 1299$	$1850.000 + 0.050 \times N$
	Downlink (BS, forward link)	$0 \leq N \leq 1299$	$1930.000 + 0.050 \times N$
AWS	Uplink (MS, reverse link)	$0 \leq N \leq 899$	$1710.000 + 0.050 \times N$
	Downlink (BS, forward link)	$0 \leq N \leq 899$	$2100.000 + 0.050 \times N$
US 2.5 GHz	Uplink (MS, reverse link)	$140 \leq N \leq 1459$	$2495.000 + 0.050 \times N$
	Downlink (BS, forward link)	$140 \leq N \leq 1459$	$2617.000 + 0.050 \times N$
700 Public Safety	Uplink (MS, reverse link)	$0 \leq N \leq 240$	$787.000 + 0.050 \times N$
	Downlink (BS, forward link)	$0 \leq N \leq 240$	$757.000 + 0.050 \times N$
C2K Lower 700	Uplink (MS, reverse link)	$0 \leq N \leq 360$	$698.000 + 0.050 \times N$
	Downlink (BS, forward link)	$0 \leq N \leq 360$	$728.000 + 0.050 \times N$
400 Euro PAMR	Uplink (MS, reverse link)	$1 \leq N \leq 400$	$0.025 \times (N - 1) + 450.000$
		$472 \leq N \leq 871$	$0.025 \times (N - 472) + 410.000$
	Uplink (MS, reverse link)	$1536 \leq N \leq 1715$	$0.025 \times (N - 1536) + 479.000$
	Uplink (MS, reverse link)		
	Downlink (BS, forward link)	$1 \leq N \leq 400$	$0.025 \times (N - 1) + 460.000$
		$472 \leq N \leq 871$	$0.025 \times (N - 472) + 420.000$
	Downlink (BS, forward link)	$1536 \leq N \leq 1715$	$0.025 \times (N - 1536) + 489.000$
Downlink (BS, forward link)			

Band	Link (Device)	Range	Frequency (MHz)
800 PAMR	Uplink (MS, reverse link)	$0 \leq N \leq 239$	$870.0125 + 0.025 \times N$
	Downlink (BS, forward link)	$0 \leq N \leq 239$	$915.0125 + 0.025 \times N$

LTE FDD Channel Number Ranges

The carrier frequency in the uplink and downlink is designated by the E-UTRA Absolute Radio Frequency Channel Number (EARFCN) in the range 0 – 65535. The relation between EARFCN and the carrier frequency in MHz for the downlink is given by the following equation, where FDL_low and NOffs-DL are given in table 5.4.4–1 and NDL is the downlink EARFCN.

$$FDL = FDL_low + 0.1(NDL - NOffs-DL)$$

The relation between EARFCN and the carrier frequency in MHz for the uplink is given by the following equation where FUL_low and NOffs-UL are given in table 5.4.4–1 and NUL is the uplink EARFCN.

$$FUL = FUL_low + 0.1(NUL - NOffs-UL)$$

Band	Downlink		Uplink			
	FDL_low (MHz)	NOffs-DL	Range of NDL	FUL_low (MHz)	NOffs-UL	Range of NUL
1		2110	0	0 – 599	1920	18000 – 18599
2		1930	600	600 – 1199	1850	18600 – 19199
3		1805	1200	1200 – 1949	1710	19200 – 19949
4		2110	1950	1950 – 2399	1710	19950 – 20399
5		869	2400	2400 – 2649	824	20400 – 20649
6		875	2650	2650 – 2749	830	20650 – 20749
7		2620	2750	2750 – 3449	2500	20750 – 20449
8		925	3450	3450 – 3799	880	21450 – 21799
9		1844.9	3800	3800 – 4149	1749.9	21800 – 22149
10		2110	4150	4150 – 4749	1710	22150 – 22749
11		1475.9	4750	4750 – 4949	1427.9	22750 – 22949

Band	Downlink	Uplink				
12	729	5010	5010 - 5179	699	23010	23010 - 23179
13	746	5180	5180 - 5279	777	23180	23180 - 23279
14	758	5280	5280 - 5379	788	23280	23280 - 23379
...						
17	734	5730	5730 - 5849	704	23730	23730 - 23849
18	860	5850	5850 - 5999	815	23850	23850 - 23999
19	875	6000	6000 - 6149	830	24000	24000 - 24149
20	791	6150	6150 - 6449	832	24150	24150 - 24449
21	1495.9	6450	6450 - 6599	1447.9	24450	24450 - 24599
...						
24	1525	7700	7700 - 8039	1626.5	25700	25700 - 26039
25	1930	8040	8040 - 8689	1850	26040	26040 - 26689
26	859	8690	8690 - 9039	814	26690	26690 - 27039
...						

Note: The channel numbers that designate carrier frequencies so close to the operating band edges that the carrier extends beyond the operating band edge shall not be used. This implies that the first 7, 15, 25, 50, 75 and 100 channel numbers at the lower operating band edge and the last 6, 14, 24, 49, 74 and 99 channel numbers at the upper operating band edge shall not be used for channel bandwidths of 1.4, 3, 5, 10, 15 and 20 MHz respectively.

LTE TDD Channel Number Ranges

The carrier frequency in the uplink and downlink is designated by the E-UTRA Absolute Radio Frequency Channel Number (EARFCN) in the range 0 – 65535. The relation between EARFCN and the carrier frequency in MHz for the downlink is given by the following equation, where FDL_low and NOffs-DL are given in table 5.4.4-1 and NDL is the downlink EARFCN.

$$FDL = FDL_low + 0.1(NDL - NOffs-DL)$$

The relation between EARFCN and the carrier frequency in MHz for the uplink is given by the following equation where FUL_low and NOffs-UL are given in table 5.4.4-1 and NUL is the uplink EARFCN.

$$FUL = FUL_low + 0.1(NUL - NOffs-UL)$$

Band	Downlink		Uplink		
	NOffs-DL	Range of ND	FUL_low (MHz)	NOffs-UL	Range of NUL
33	1900	36000	36000 - 36199	1900	36000 - 36199
34	2010	36200	36200 - 36349	2010	36200 - 36349
35	1850	36350	36350 - 36949	1850	36350 - 36949
36	1930	36950	36950 - 37549	1930	36950 - 37549
37	1910	37550	37550 - 37749	1910	37550 - 37749
38	2570	37750	37750 - 38249	2570	37750 - 38249
39	1880	38250	38250 - 38649	1880	38250 - 38649
40	2300	38650	38650 - 39649	2300	38650 - 39649
41	2496	39650	39650 - 41589	2496	39650 - 41589
42	3400	41590	41590 - 43589	3400	41590 - 43589
43	3600	43590	43590 - 45589	3600	43590 - 45589

Note: The channel numbers that designate carrier frequencies so close to the operating band edges that the carrier extends beyond the operating band edge shall not be used. This implies that the first 7, 15, 25, 50, 75 and 100 channel numbers at the lower operating band edge and the last 6, 14, 24, 49, 74 and 99 channel numbers at the upper operating band edge shall not be used for channel bandwidths of 1.4, 3, 5, 10, 15 and 20 MHz respectively.

TDSCDMA Channel Number Ranges

1.28 Mcps TDD Option

No TX-RX frequency separation is required as Time Division Duplex (TDD) is employed. Each subframe consists of 7 main timeslots where all main timeslots (at least the first one) before the single switching point are allocated DL and all main timeslots (at least the last one) after the single switching point are allocated UL.

The nominal channel spacing is 1.6 MHz, but this can be adjusted to optimise performance in a particular deployment scenario.

The carrier frequency is designated by the UTRA absolute radio frequency channel number (UARFCN). The value of the UARFCN in the IMT2000 band is defined in the general case as follows:

$$N_t = 5 * F \text{ 0.0 MHz } \leq F \leq 3276.6 \text{ MHz}$$

where F is the carrier frequency in MHz

Additional channels applicable to operation in the frequency band defined in sub-clause 5.2(d) are defined via the following UARFCN definition:

$$N_t = 5 * (F - 2150.1 \text{ MHz}) / 2572.5 \text{ MHz} \leq F \leq 2617.5 \text{ MHz}$$

UARFCN

1.28 Mcps TDD Option

The following UARFCN range shall be supported for each band:

**Table: UTRA Absolute Radio
Frequency Channel Number 1.28
Mcps TDD Option**

Frequency Band	Frequency Range	UARFCN Uplink and Downlink transmission
For operation in frequency band as defined in subclause 5.2 (a)	1900-1920 MHz	9504 to 9596
	2010-2025 MHz	10054 to 10121
For operation in frequency band as defined in subclause 5.2 (b)	1850-1910 MHz	9254 to 9546
	1930-1990 MHz	9654 to 9946
For operation in frequency band as defined in subclause 5.2 (c)	1910-1930 MHz	9554 to 9646
For operation in frequency band as defined in subclause 5.2 (d)	2570-2620 MHz	12854 to 13096
For operation in frequency band as defined in subclause 5.2 (e)	2300-2400 MHz	11504 to 11996
For operation in frequency band as defined in subclause 5.2 (f)	1880-1920 MHz	9404 to 9596

Radio Setup

Allows access to the sub-menus for selecting the radio standard and associated radio band. You can also set a frequency reference and offset.

This menu is greyed out when on E6630A. Radio band settings for GSM, cdma2000, and so on -- most of which are not actually supported in E6630A, which has three narrow frequency bands. So band settings are grayed out.

Key Path	Source, Frequency
Initial S/W Revision	A.05.00

Radio Standard

Allows access to the channel band sub-menus to select the desired radio standard. When you have selected the radio standard, you can then set an active channel band. The radio standard and the active

channel band allow you to use channel numbers to set frequency automatically.

Key Path	Source, Frequency, Radio Setup
Remote Command	:SOURce:FREQuency:CHANnels:BAND NONE PGSM EGSM RGSM DCS1800 PCS1900 TGSM810 GSM450 GSM480 GSM700 GSM850 BANDI BANDII BANDIII BANDIV BANDV BANDVI BANDVII BANDVIII BANDIX BANDX BANDXI BANDXII BANDXIII BANDXIV BANDXIX USCELL USPCS JAPAN KOREAN NMT IMT2K UPPER SECOND PAMR400 PAMR800 IMTEXT PCS1DOT9G AWS US2DOT5G PUBLIC LOWER BAND1 BAND2 BAND3 BAND4 BAND5 BAND6 BAND7 BAND8 BAND10 BAND11 BAND12 BAND13 BAND14 BAND17 BAND18 BAND19 BAND20 BAND21 BAND24 BAND25 BAND26 BAND27 BAND28 BAND29 BAND30 BAND31 BAND33 BAND34 BAND35 BAND36 BAND37 BAND38 BAND39 BAND40 BAND41 BAND42 BAND43 BAND44 BANDA BANDB BANDC BANDD BANDE BANDF :SOURce:FREQuency:CHANnels:BAND?
Example	:SOUR:FREQ:CHAN:BAND PGSM
Notes	Set this setting to "NONE" will grey out "Channel" on page 2103 Channel
Initial S/W Revision	A.05.00

None

Selects no radio standard for use. When you have selected the radio standard to NONE, you cannot use channel numbers to set frequency automatically. You will need to set the frequency manually.

Key Path	Source, Frequency, Radio Setup, Radio Standard
Initial S/W Revision	A.05.00

GSM/EDGE

Sets GSM/EDGE as the radio standard for use and accesses the GSM/EDGE specific channel band sub-menus.

Key Path	Source, Frequency, Radio Setup, Radio Standard
Initial S/W Revision	A.05.00

P-GSM

Selects P-GSM as the active channel band.

Key Path	Source, Frequency, Radio Setup, Radio Standard, GSM/EDGE
Example	:SOUR:FREQ:CHAN:BAND PGSM
Initial S/W Revision	A.05.00

E-GSM

Selects E-GSM as the active channel band.

Key Path	Source, Frequency, Radio Setup, Radio Standard, GSM/EDGE
Example	:SOUR:FREQ:CHAN:BAND EGSM
Initial S/W Revision	A.05.00

R-GSM

Selects R-GSM as the active channel band.

Key Path	Source, Frequency, Radio Setup, Radio Standard, GSM/EDGE
Example	:SOUR:FREQ:CHAN:BAND RGSM
Initial S/W Revision	A.05.00

DCS 1800

Selects DCS 1800 as the active channel band.

Key Path	Source, Frequency, Radio Setup, Radio Standard, GSM/EDGE
Example	:SOUR:FREQ:CHAN:BAND DCS1800
Initial S/W Revision	A.05.00

PCS 1900

Selects PCS 1900 as the active channel band.

Key Path	Source, Frequency, Radio Setup, Radio Standard, GSM/EDGE
Example	:SOUR:FREQ:CHAN:BAND PCS1900
Initial S/W Revision	A.05.00

GSM 450

Selects GSM 450 as the active channel band.

Key Path	Source, Frequency, Radio Setup, Radio Standard, GSM/EDGE
Example	:SOUR:FREQ:CHAN:BAND GSM450
Initial S/W Revision	A.05.00

GSM 480

Selects GSM 480 as the active channel band.

Key Path	Source, Frequency, Radio Setup, Radio Standard, GSM/EDGE
Example	:SOUR:FREQ:CHAN:BAND GSM480
Initial S/W Revision	A.05.00

GSM 850

Selects GSM 850 as the active channel band.

Key Path	Source, Frequency, Radio Setup, Radio Standard, GSM/EDGE
Example	:SOUR:FREQ:CHAN:BAND GSM850
Initial S/W Revision	A.05.00

GSM 700

Selects GSM 700 as the active channel band.

Key Path	Source, Frequency, Radio Setup, Radio Standard, GSM/EDGE
Example	:SOUR:FREQ:CHAN:BAND GSM700
Initial S/W Revision	A.05.00

T-GSM 810

Selects T-GSM 810 as the active channel band.

Key Path	Source, Frequency, Radio Setup, Radio Standard, GSM/EDGE
Example	:SOUR:FREQ:CHAN:BAND T-GSM810
Initial S/W Revision	A.05.00

WCDMA

Sets WCDMA as the radio standard for use and accesses the W-CDMA specific channel band sub-menus.

Key Path	Source, Frequency, Radio Setup, Radio Standard
Initial S/W Revision	A.05.00

Band I

Selects Band I as the active channel band.

Key Path	Source, Frequency, Radio Setup, Radio Standard, WCDMA
Example	:SOUR:FREQ:CHAN:BAND BANDI
Initial S/W Revision	A.05.00

Band II

Selects Band II as the active channel band.

Key Path	Source, Frequency, Radio Setup, Radio Standard, WCDMA
Example	:SOUR:FREQ:CHAN:BAND BANDII
Initial S/W Revision	A.05.00

Band III

Selects Band III as the active channel band.

Key Path	Source, Frequency, Radio Setup, Radio Standard, WCDMA
Example	:SOUR:FREQ:CHAN:BAND BANDIII
Initial S/W Revision	A.05.00

Band IV

Selects Band IV as the active channel band.

Key Path	Source, Frequency, Radio Setup, Radio Standard, WCDMA
Example	:SOUR:FREQ:CHAN:BAND BANDIV
Initial S/W Revision	A.05.00

Band V

Selects Band V as the active channel band.

Key Path	Source, Frequency, Radio Setup, Radio Standard, WCDMA
Example	:SOUR:FREQ:CHAN:BAND BANDV
Initial S/W Revision	A.05.00

Band VI

Selects Band VI as the active channel band.

Key Path	Source, Frequency, Radio Setup, Radio Standard, WCDMA
Example	:SOUR:FREQ:CHAN:BAND BANDVI
Initial S/W Revision	A.05.00

Band VII

Selects Band VII as the active channel band.

Key Path	Source, Frequency, Radio Setup, Radio Standard, WCDMA
Example	:SOUR:FREQ:CHAN:BAND BANDVII
Initial S/W Revision	A.05.00

Band VIII

Selects Band VIII as the active channel band.

Key Path	Source, Frequency, Radio Setup, Radio Standard, WCDMA
Example	:SOUR:FREQ:CHAN:BAND BANDVIII
Initial S/W Revision	A.05.00

Band IX

Selects Band IX as the active channel band.

Key Path	Source, Frequency, Radio Setup, Radio Standard, WCDMA
Example	:SOUR:FREQ:CHAN:BAND BANDIX
Initial S/W Revision	A.05.00

Band X

Selects Band X as the active channel band.

Key Path	Source, Frequency, Radio Setup, Radio Standard, WCDMA
Example	:SOUR:FREQ:CHAN:BAND BANDX
Initial S/W Revision	A.05.00

Band XI

Selects Band XI as the active channel band.

Key Path	Source, Frequency, Radio Setup, Radio Standard, WCDMA
Example	:SOUR:FREQ:CHAN:BAND BANDXI
Initial S/W Revision	A.05.00

Band XII

Selects Band XII as the active channel band.

Key Path	Source, Frequency, Radio Setup, Radio Standard, WCDMA
Example	:SOUR:FREQ:CHAN:BAND BANDXII
Initial S/W Revision	A.05.00

Band XIII

Selects band XIII as the active channel band.

Key Path	Source, Frequency, Radio Setup, Radio Standard, WCDMA
Example	:SOUR:FREQ:CHAN:BAND BANDXIII
Initial S/W Revision	A.05.00

Band XIV

Selects Band XIV as the active channel band.

Key Path	Source, Frequency, Radio Setup, Radio Standard, WCDMA
Example	:SOUR:FREQ:CHAN:BAND BANDXIV
Initial S/W Revision	A.05.00

LTE

Sets LTE FDD as the radio standard for use and accesses the LTE FDD specific channel band sub-menus..

Key Path	Source, Frequency, Radio Setup, Radio Standard
Initial S/W Revision	A.09.50

BAND 1

Selects BAND 1 as the band for the current step.

Key Path	Source, Frequency, Radio Setup, Radio Standard, LTE
----------	---

Example	:SOUR:FREQ:CHAN:BAND BAND1
Initial S/W Revision	A.09.50

BAND 2

Selects BAND 2 as the band for the current step.

Key Path	Source, Frequency, Radio Setup, Radio Standard, LTE
Example	:SOUR:FREQ:CHAN:BAND BAND2
Initial S/W Revision	A.09.50

BAND 3

Selects BAND 3 as the band for the current step.

Key Path	Source, Frequency, Radio Setup, Radio Standard, LTE
Example	:SOUR:FREQ:CHAN:BAND BAND3
Initial S/W Revision	A.09.50

BAND 4

Selects BAND 4 as the band for the current step.

Key Path	Source, Frequency, Radio Setup, Radio Standard, LTE
Example	:SOUR:FREQ:CHAN:BAND BAND4
Initial S/W Revision	A.09.50

BAND 5

Selects BAND 5 as the band for the current step.

Key Path	Source, Frequency, Radio Setup, Radio Standard, LTE
Example	:SOUR:FREQ:CHAN:BAND BAND5
Initial S/W Revision	A.09.50

BAND 6

Selects BAND 6 as the band for the current step.

Key Path	Source, Frequency, Radio Setup, Radio Standard, LTE
----------	---

Example	:SOUR:FREQ:CHAN:BAND BAND6
Initial S/W Revision	A.09.50

BAND 7

Selects BAND 7 as the band for the current step.

Key Path	Source, Frequency, Radio Setup, Radio Standard, LTE
Example	:SOUR:FREQ:CHAN:BAND BAND7
Initial S/W Revision	A.09.50

BAND 8

Selects BAND 8 as the band for the current step.

Key Path	Source, Frequency, Radio Setup, Radio Standard, LTE
Example	:SOUR:FREQ:CHAN:BAND BAND8
Initial S/W Revision	A.09.50

BAND 9

Selects BAND 9 as the band for the current step.

Key Path	Source, Frequency, Radio Setup, Radio Standard, LTE
Example	:SOUR:FREQ:CHAN:BAND BAND9
Initial S/W Revision	A.09.50

BAND 10

Selects BAND 10 as the band for the current step.

Key Path	Source, Frequency, Radio Setup, Radio Standard, LTE
Example	:SOUR:FREQ:CHAN:BAND BAND10
Initial S/W Revision	A.09.50

BAND 11

Selects BAND 11 as the band for the current step.

Key Path	Source, Frequency, Radio Setup, Radio Standard, LTE
----------	---

Example	:SOUR:FREQ:CHAN:BAND BAND11
Initial S/W Revision	A.09.50

BAND 12

Selects BAND 12 as the band for the current step.

Key Path	Source, Frequency, Radio Setup, Radio Standard, LTE
Example	:SOUR:FREQ:CHAN:BAND BAND12
Initial S/W Revision	A.09.50

BAND 13

Selects BAND 13 as the band for the current step.

Key Path	Source, Frequency, Radio Setup, Radio Standard, LTE
Example	:SOUR:FREQ:CHAN:BAND BAND13
Initial S/W Revision	A.09.50

BAND 14

Selects BAND 14 as the band for the current step.

Key Path	Source, Frequency, Radio Setup, Radio Standard, LTE
Example	:SOUR:FREQ:CHAN:BAND BAND14
Initial S/W Revision	A.09.50

BAND 17

Selects BAND 17 as the band for the current step.

Key Path	Source, Frequency, Radio Setup, Radio Standard, LTE
Example	:SOUR:FREQ:CHAN:BAND BAND17
Initial S/W Revision	A.09.50

BAND 18

Selects BAND 18 as the band for the current step.

Key Path	Source, Frequency, Radio Setup, Radio Standard, LTE
----------	---

Example	:SOUR:FREQ:CHAN:BAND BAND18
Initial S/W Revision	A.09.50

BAND 19

Selects BAND 19 as the band for the current step.

Key Path	Source, Frequency, Radio Setup, Radio Standard, LTE
Example	:SOUR:FREQ:CHAN:BAND BAND19
Initial S/W Revision	A.09.50

BAND 20

Selects BAND 20 as the band for the current step.

Key Path	Source, Frequency, Radio Setup, Radio Standard, LTE
Example	:SOUR:FREQ:CHAN:BAND BAND20
Initial S/W Revision	A.09.50

BAND 21

Selects BAND 21 as the band for the current step.

Key Path	Source, Frequency, Radio Setup, Radio Standard, LTE
Example	:SOUR:FREQ:CHAN:BAND BAND21
Initial S/W Revision	A.09.50

BAND 24

Selects BAND 24 as the band for the current step.

Key Path	Source, Frequency, Radio Setup, Radio Standard, LTE
Example	:SOUR:FREQ:CHAN:BAND BAND24
Initial S/W Revision	A.09.50

BAND 25

Selects BAND 25 as the band for the current step.

Key Path	Source, Frequency, Radio Setup, Radio Standard, LTE
----------	---

Example	:SOUR:FREQ:CHAN:BAND BAND25
Initial S/W Revision	A.09.50

BAND 26

Selects BAND 26 as the band for the current step.

Key Path	Source, Frequency, Radio Setup, Radio Standard, LTE
Example	:SOUR:FREQ:CHAN:BAND BAND26
Initial S/W Revision	A.12.53

BAND 27

Selects BAND 27 as the band for the current step.

Key Path	Source, Frequency, Radio Setup, Radio Standard, LTE
Example	:SOUR:FREQ:CHAN:BAND BAND27
Initial S/W Revision	A.14.00

BAND 28

Selects BAND 28 as the band for the current step.

Key Path	Source, Frequency, Radio Setup, Radio Standard, LTE
Example	:SOUR:FREQ:CHAN:BAND BAND28
Initial S/W Revision	A.14.00

BAND 31

Selects BAND 31 as the band for the current step.

Key Path	Source, Frequency, Radio Setup, Radio Standard, LTE
Example	:SOUR:FREQ:CHAN:BAND BAND31
Initial S/W Revision	A.14.00

LTE TDD

Sets LTE TDD as the radio standard for use and accesses the LTE TDD specific channel band sub-menus..

Key Path	Source, Frequency, Radio Setup, Radio Standard
Initial S/W Revision	A.11.50

BAND 33

Selects BAND 33 as the band for the current step.

Key Path	Source, Frequency, Radio Setup, Radio Standard, LTE TDD
Example	:SOUR:FREQ:CHAN:BAND BAND33
Initial S/W Revision	A.11.50

BAND 34

Selects BAND 34 as the band for the current step.

Key Path	Source, Frequency, Radio Setup, Radio Standard, LTE TDD
Example	:SOUR:FREQ:CHAN:BAND BAND34
Initial S/W Revision	A.11.50

BAND 35

Selects BAND 35 as the band for the current step.

Key Path	Source, Frequency, Radio Setup, Radio Standard, LTE TDD
Example	:SOUR:FREQ:CHAN:BAND BAND35
Initial S/W Revision	A.11.50

BAND 36

Selects BAND 36 as the band for the current step.

Key Path	Source, Frequency, Radio Setup, Radio Standard, LTE TDD
Example	:SOUR:FREQ:CHAN:BAND BAND36
Initial S/W Revision	A.11.50

BAND 37

Selects BAND 37 as the band for the current step.

Key Path	Source, Frequency, Radio Setup, Radio Standard, LTE TDD
Example	:SOUR:FREQ:CHAN:BAND BAND37
Initial S/W Revision	A.11.50

BAND 38

Selects BAND 38 as the band for the current step.

Key Path	Source, Frequency, Radio Setup, Radio Standard, LTE TDD
Example	:SOUR:FREQ:CHAN:BAND BAND38
Initial S/W Revision	A.11.50

BAND 39

Selects BAND 39 as the band for the current step.

Key Path	Source, Frequency, Radio Setup, Radio Standard, LTE TDD
Example	:SOUR:FREQ:CHAN:BAND BAND39
Initial S/W Revision	A.11.50

BAND 40

Selects BAND 40 as the band for the current step.

Key Path	Source, Frequency, Radio Setup, Radio Standard, LTE TDD
Example	:SOUR:FREQ:CHAN:BAND BAND40
Initial S/W Revision	A.11.50

BAND 41

Selects BAND 41 as the band for the current step.

Key Path	Source, Frequency, Radio Setup, Radio Standard, LTE TDD
Example	:SOUR:FREQ:CHAN:BAND BAND41
Initial S/W Revision	A.11.50

BAND 42

Selects BAND 42 as the band for the current step.

Key Path	Source, Frequency, Radio Setup, Radio Standard, LTE TDD
Example	:SOUR:FREQ:CHAN:BAND BAND42
Initial S/W Revision	A.11.50

BAND 43

Selects BAND 43 as the band for the current step.

Key Path	Source, Frequency, Radio Setup, Radio Standard, LTE TDD
Example	:SOUR:FREQ:CHAN:BAND BAND43
Initial S/W Revision	A.11.50

BAND 44

Selects BAND 44 as the band for the current step.

Key Path	Source, Frequency, Radio Setup, Radio Standard, LTE TDD
Example	:SOUR:FREQ:CHAN:BAND BAND44
Initial S/W Revision	A.14.00

TDSCDMA

Sets TDSCDMA as the radio standard for use and accesses the TDSCDMA specific channel band sub-menus..

Key Path	Source, Frequency, Radio Setup, Radio Standard
Initial S/W Revision	A.11.50

BAND A

Selects BAND A as the band for the current step.

Key Path	Source, Frequency, Radio Setup, Radio Standard, TDSCDMA
Example	:SOUR:FREQ:CHAN:BAND BANDA
Initial S/W Revision	A.11.50

BAND B

Selects BAND B as the band for the current step.

Key Path	Source, Frequency, Radio Setup, Radio Standard, TDSCDMA
Example	:SOUR:FREQ:CHAN:BAND BANDB
Initial S/W Revision	A.11.50

BAND C

Selects BAND C as the band for the current step.

Key Path	Source, Frequency, Radio Setup, Radio Standard, TDSCDMA
Example	:SOUR:FREQ:CHAN:BAND BANDC
Initial S/W Revision	A.11.50

BAND D

Selects BAND D as the band for the current step.

Key Path	Source, Frequency, Radio Setup, Radio Standard, TDSCDMA
Example	:SOUR:FREQ:CHAN:BAND BANDD
Initial S/W Revision	A.11.50

BAND E

Selects BAND E as the band for the current step.

Key Path	Source, Frequency, Radio Setup, Radio Standard, TDSCDMA
Example	:SOUR:FREQ:CHAN:BAND BANDE
Initial S/W Revision	A.11.50

BAND F

Selects BAND F as the band for the current step.

Key Path	Source, Frequency, Radio Setup, Radio Standard, TDSCDMA
Example	:SOUR:FREQ:CHAN:BAND BANDF
Initial S/W Revision	A.11.50

Radio Band Link

Allows you to specify the channel band type as either uplink or downlink link direction. This value is used in conjunction with the channel band and channel number to determine the absolute frequency output by the source. When set to “Uplink”, the source will calculate the uplink frequency using an uplink formula together with the selected channel band and channel number . When set to “Downlink”, the source will calculate the downlink frequency using a downlink formula together with the selected channel band and channel number.

Key Path	Source, Frequency, Radio Setup
Remote Command	:SOURce:RADio:BAND:LINK DOWN UP :SOURce:RADio:BAND:LINK?

Example	:SOUR:RAD:BAND:LINK UP
Preset	DOWN
Range	DOWN UP
Backwards Compatibility SCPI	:SOURce:RADio:DEVIce BTS MS :SOURce:RADio:DEVIce?
Backwards Compatibility Notes	BTS maps to the Downlink frequency MS maps to the Uplink frequency
Initial S/W Revision	A.05.00

Set Reference Frequency

This key allows you to set the frequency reference. Pressing this key turns the frequency reference state to ON, sets the reference frequency value to the current frequency, maintains this frequency at the RF output, and sets the displayed frequency to 0.00 Hz. All subsequent frequencies entered under Source>Frequency>Frequency are interpreted as being relative to this reference frequency.

When you use a frequency reference, the signal generator outputs a frequency that is set relative to the reference frequency by the value entered under Source>Frequency>Frequency as follows:

$$\text{Output frequency} = \text{reference frequency} - \text{entered frequency}$$

Where:

reference frequency equals the original RF frequency entered under Source>Frequency>Frequency and set as the reference frequency

entered frequency equals a new value entered under Source>Frequency>Frequency

In addition, the displayed frequency value will be the same as the value entered under Source>Frequency>Frequency.

NOTE

If Freq Reference is set to ON with a reference value set, entering a value under Source>Frequency>Frequency and pressing Set Frequency Reference will add that value to the existing Freq Reference value.

If you wish to change the reference frequency value to the new value entered under Source>Frequency>Frequency, first you must set Freq Reference to OFF and then press Set Frequency Reference.

Key Path	Source, Frequency
Remote Command	:SOURce:FREQuency:REFErence:SET
Example	:SOUR:FREQ:REF:SET
Dependencies	This setting is unavailable, and is grayed out when the List Sequencer is turned ON.
Initial S/W Revision	A.05.00

Freq Reference

This key allows you to toggle the state of the frequency reference. When the frequency reference state is ON, an annunciator is displayed on the main source view to indicate this state to the user.

When you use a frequency reference, the signal generator outputs a frequency that is set relative to the reference frequency by the value entered under Source>Frequency>Frequency as follows:

Output frequency = reference frequency + entered frequency

Where:

reference frequency equals the original RF frequency entered under Source>Frequency>Frequency and set as the reference frequency

entered frequency equals a new value entered under Source>Frequency>Frequency

For more information on Reference Frequency refer to ["Set Reference Frequency" on page 2127](#)

Key Path	Source, Frequency
Remote Command	:SOURce:FREQuency:REFerence <freq> :SOURce:FREQuency:REFerence? :SOURce:FREQuency:REFerence:STATe OFF ON 0 1 :SOURce:FREQuency:REFerence:STATe?
Example	:SOUR:FREQ:REF 0.00 Hz :SOUR:FREQ:REF:STATe ON
Dependencies	This setting is unavailable, and is grayed out when the List Sequencer is turned ON.
Couplings	The frequency reference state is coupled to the frequency reference set immediate action. When the reference set immediate action key is pressed, or the SCPI command issued, it turns the frequency reference state ON.
Preset	0.00 Hz OFF
Min	0.00 Hz
Max	Hardware Dependant: Option 503 = 3.6 GHz Option 504 = 3.8 GHz Option 506 = 6.00 GHz
Initial S/W Revision	A.05.00

Freq Offset

Allows you to specify the frequency offset value. When the frequency offset state is ON, an annunciator is displayed on the main source view to indicate this state to the user.

When the frequency offset is set to zero (0) and you set a new offset value, the displayed frequency value will change as follows and the RF output frequency will not change:

Displayed value = output frequency + offset value

Where:

output frequency equals the original frequency entered under Source>Frequency>Frequency

offset value equals the value entered under Source>Frequency>Freq Offset

When the frequency offset is set to a value other than zero (0) and you enter a new frequency value under Source>Frequency>Frequency, the displayed frequency will be the same as the value entered and the RF output frequency will be equal to the value entered minus the offset value as follows:

Output frequency = entered frequency – offset frequency

Displayed frequency = output frequency + offset frequency

Displayed frequency = entered frequency

Where:

entered frequency equals the frequency entered under Source>Frequency>Frequency

offset frequency equals the value previously entered and set under Source>Frequency>Freq Offset

Key Path	Source, Frequency
Remote Command	:SOURce:FREQuency:OFFSet <freq> :SOURce:FREQuency:OFFSet?
Example	:SOUR:FREQ:OFFS 0 Hz
Dependencies	This setting is unavailable, and is grayed out when the List Sequencer is turned ON.
Preset	0 Hz
Min	-100.00 GHz
Max	100.00 GHz
Initial S/W Revision	A.05.00

Modulation Setup

Allows access to the menus for setting up the available modulation types: "ARB" on page 2143, "AM" on page 2164, "FM" on page 2165, and "PM" on page 2167.

Key Path	Source
Initial S/W Revision	A.05.00

ARB

Allows you access to the ARB sub-menus.

Key Path	Source, Modulation Setup
Initial S/W Revision	A.05.00

ARB

Allows you to toggle the state of the ARB function. When the ARB is On, a “MOD” annunciator is displayed in the system settings panel. When the ARB is turned Off, the MOD annunciator is cleared

Key Path	Source, Modulation Setup, ARB
Remote Command	:SOURce:RADio:ARB[:STATe] ON OFF 1 0 :SOURce:RADio:ARB[:STATe]?
Example	:SOUR:RAD:ARB OFF :SOUR:RAD:ARB?
Notes	If the ARB is ON, a user then loads or deletes another file to ARB memory, the playing waveform segment may not keep phase continuity during the ARB memory operation. The waveform will be replayed after the ARB operation is finished.
Dependencies	This setting is for independent mode and has no effect on 3.3.8 list sequencer mode. Setting "Sequencer" on page 2168 Sequencer to On will put source enter list sequencer mode, and even if ARB state is On, the ARB file will not be played. Setting "Sequencer" on page 2168 Sequencer to Off will make source leave list sequencer mode, and this setting will take effect immediately. The ARB can only be turned on when there is a waveform file selected for playback. On the GUI If no waveform is selected, this key is grayed out. If you send the SCPI command to turn the ARB on with no waveform selected for playback, the ARB state remains OFF and an error is generated. "- When you try to recall a certain set of states in which the selected waveform is not in ARB memory and the ARB state is On, errors are reported
Preset	Off
Range	On Off
Initial S/W Revision	A.05.00

Select Waveform

Allows you to access to the waveform selection sub-menus.

Pressing this key changes the central view area to show the Waveform File Selection view.

Key Path	Source, Modulation Setup, ARB
Initial S/W Revision	A.05.00

Select Waveform

Allows you to select a waveform sequence or segment for the dual ARB to play.

NOTE: Selecting a waveform file does not result in automatic adjustments to burst timing (to compensate for the presence or absence of a Multiport Adapter); that adjustment occurs only when a waveform is loaded to ARB memory. See "Load Segment to ARB Memory" for more information about this adjustment.

Key Path	Source, Modulation Setup, ARB, Select Waveform
Remote Command	:SOURCE:RADio:ARB:WAVEform <string> :SOURCE:RADio:ARB:WAVEform?
Example	:SOUR:RAD:ARB:WAV "test_waveform.bin"
Notes	<p>If intended waveform is not in the memory yet, then issuing this command by SCPI will invoke ARB loading operation first, which involves a delay of unpredictable length. So this command should be followed by the query *OPC?, which holds off subsequent commands until the loading operation is complete.</p> <p><string> - specifies the name of the waveform segment or waveform sequence to be played by the ARB.</p> <p>When in Sequence Analyzer mode, and Include Source is Yes, if the you attempt to play a waveform sequence but not all the required waveform segments are in the ARB playback memory, the application will reject the loading operation with an error is generated .</p> <p>When Include Source is No, if you attempt to play a waveform sequence but not all the required waveform segments are contained in the ARB playback memory, the application will attempt to load the required segments from either the default directory of the current directory. If the ARB memory does not have enough space for all the waveform segments to be loaded, an error is generated and none of the waveform segments is loaded.</p> <p>If the ARB is ON, and you attempt to play a waveform sequence but not all the waveform segments within the sequence could be found to be loaded into ARB memory, an error is generated. The selected waveform keeps the previous value and ARB state remains On.</p> <p>If you specify a waveform segment over SCPI but the waveform segment is not present within ARB playback memory and cannot be found for auto loading within the current directory or the default directory, an error is generated and the file selection remains unchanged.</p> <p>If you select a waveform for playback and the waveform requires a license that is not installed on the instrument, an error is generated. error is generated.</p> <p>If the ARB is ON and you load a file to ARB memory or delete a file from ARB memory, the playing waveform segment may not keep phase continuity during the ARB memory operation. The waveform will be replayed after the ARB operation is finished.</p>
Initial S/W Revision	A.05.00

Segments on Hard Disk

Allows you access to the sub-menus for loading waveform segments from the hard disk into ARB memory. The default directory is: D: varb.

Pressing this key changes the current view to the Waveform Management View.

Key Path	Source, Modulation Setup, ARB, Select Waveform
Initial S/W Revision	A.05.00

Load Segment To ARB Memory

Allows you to load the selected file into ARB memory. On the front panel you select the file for loading to the ARB memory by highlighting the desired file in the list. Using the SCPI command, you specify the file

name on the HDD.

“NVWFM” (none-volatile storage) MSUS (Mass Storage Unit Specifier) is supported in the memory subsystem because the ARB memory cannot be accessed directly. Therefore, files must be downloaded to the instrument hard disk and then loaded into the ARB memory. “NVWFM” MSUS will be mapped to the default directory D: VARB. The SCPI command supports using either “NVWFM” MSUS or specifying a full path. For more information, see Memory Subsystem (Remote Command Only).

If a file of the same name already exists within ARB memory, it is overwritten. If you wish to load two segments of the same name, you must rename one of the segments before loading it into ARB memory. To rename a segment, you can either use Windows File Explorer, or the :MMEMory:COPI command.

NOTE: When a waveform file is loaded to ARB memory, burst timing adjustments are made automatically, based on whether or not a Multiport Adapter is connected to the test set and powered on. If the connection/power status of the Multiport Adapter is changed after a waveform file has been loaded, it needs to be loaded again.

Key Path	Source, Modulation Setup, ARB, Select Waveform, Segments on Hard Disk
Remote Command	:SOURce:RADio:ARB:LOAD <string>
Example	:SOUR:RAD:ARB:LOAD "D: VARB\testwaveform.bin" or :SOUR:RAD:ARB:LOAD "NVWFM:testwaveform.bin"
Notes	<p>Because loading the file involves a delay of unpredictable length, this command should be followed by the query *OPC?, which holds off subsequent commands until the loading operating is complete.</p> <p><string> – specifies the path name of the file to load from the HDD into ARB memory. It could be a <full path + filename>, or <“NVWFM” MSUS + colon + filename>.</p> <p>When in Sequence Analyzer mode, and Include Source is Yes, an attempt to load a file to ARB memory will be rejected with an error.</p> <p>When Include Source is No and if there is insufficient free ARB memory to load the selected waveform, an error is generated. .</p> <p>If you specify a file over SCPI, but the file is not at the specified location, an error is generated.</p> <p>If you try to load a waveform file but the file contains less than 500 IQ samples, an error is generated.</p> <p>If you try to load a Signal Studio waveform “*.wfm” which contains invalid waveform header, an error is generated.</p> <p>If the ARB is ON when you load a file to ARB memory or delete a file from ARB memory, the playing waveform segment may not keep phase continuity during the ARB memory operation. The waveform will be replayed after the ARB operation is finished.</p> <p>ARB can be loaded into ARB memory even required licenses do not present on the instrument. In this case, a GUI only warning message -800, “Operation complete; Loaded <filename> successfully, but no license <required licenses> installed”. User can install required licenses according to <required licenses> string to license it, or multi-pack license it.</p>
Initial S/W Revision	A.05.00

Load All To ARB Memory

Allows you to load all the segment files within the currently selected directory into ARB memory. If a file of the same name already exists within ARB memory, it is overwritten. If you wish to load two segments of the

same name, you must rename one of the segments before loading it into ARB memory. To rename a segment, you can either use Windows File Explorer, or the :MEMory:COpy command.

NOTE: When a waveform file is loaded to ARB memory, burst timing adjustments are made automatically, based on whether or not a Multiport Adapter is connected to the test set and powered on. If the connection/power status of the Multiport Adapter is changed after a waveform file has been loaded, it needs to be loaded again.

Key Path	Source, Modulation Setup, ARB, Select Waveform, Segments on Hard Disk
Remote Command	:SOURce:RADio:ARB:LOAD:ALL <string>
Example	:SOUR:RAD:ARB:LOAD:ALL "D: varb"
Notes	<p><string> - specifies the directory on the HDD to load the files into ARB memory from.</p> <p>When in Sequence Analyzer mode, and Include Source is Yes, an attempt to load all files from a directory to ARB memory is rejected with an error.</p> <p>When Include Source is No and there is insufficient free ARB memory to load all the waveforms, when the ARB memory is full, the copy ceases, and an error is generated.</p> <p>If you specify a directory over SCPI, but the directory does not exist, an error is generated.</p> <p>If the ARB is ON, a user then loads or deletes file to ARB memory, the playing waveform segment may not keep phase continuity during the ARB memory operation. The waveform will be replayed after the ARB operation is finished.</p>
Initial S/W Revision	A.05.00

Change Directory...

Allows you to change the currently selected directory on the hard disk. Pressing this key opens a standard windows change directory dialog allowing you to select the new directory of interest.

The current directory is used for manually loading waveform segments into ARB memory for playback, and as a search location for waveform segments that are required to be loaded into ARB memory for playback of a waveform sequence or a list sequence.

Key Path	Source, Modulation Setup, ARB, Select Waveform, Segments on Hard Disk
Notes	No remote command, SCPIfront panel only.
Initial S/W Revision	A.05.00

Default Directory...

Allows you to change the default directory. It is used as a search location for waveform segments that are required to be loaded into ARB memory for playback of a waveform sequence, and as a search location for selecting waveforms using SCPI.

Key Path	Source, Modulation Setup, ARB, Select Waveform, Segments on Hard Disk
Remote Command	:SOURce:RADio:ARB:DEFault:DIRectory <string> :SOURce:RADio:ARB: DEFault:DIRectory?
Example	:SOUR:RAD:ARB:DEF:DIR "D:\ArbFiles"

	:SOUR:RAD:ARB:DEF:DIR?
State Saved	Persistent, survives a power cycle and a preset but not saved in the instrument state
Initial S/W Revision	A.05.00

Segments in ARB Memory

Allows you access to the sub-menus for managing the files within ARB memory.

Key Path	Source, Modulation Setup, ARB, Select Waveform
Initial S/W Revision	A.05.00

Delete Segment From ARB Mem

Allows you to remove a segment from ARB playback memory.

Key Path	Source, Modulation Setup, ARB, Select Waveform, Segments in ARB Memory
Remote Command	:SOURce:RADio:ARB:DELeTe <string>
Example	:SOUR:RAD:ARB:DEL "testwaveform.bin"
Notes	<p><string> - specifies the waveform to be deleted from the ARB playback memory.</p> <p>When in Sequence Analyzer mode and Include Source is Yes, an attempt to delete a file from ARB memory is rejected with an error.</p> <p>When Include Source is No and you specify a file that does not exist within ARB memory, an error is generated.</p> <p>It is possible to delete files from within the ARB memory when the ARB is ON. However, if you attempt to delete the file that is currently playing an error is generated.</p> <p>It is possible to delete a file from within the ARB memory when the sequencer state is ON and the file is not being used by the List Sequencer. If you attempt to delete a file which is being used by the list sequencer, an error is generated.</p> <p>When sequencer state is On, even if ARB state is On, the selected waveform will not be played. In this case, if the selected waveform is not used in List Sequence, it can be deleted and the ARB state is turned Off.</p> <p>If the ARB is ON and you load a file to ARB memory or delete a file from ARB memory, the playing waveform segment may not keep phase continuity during the ARB memory operation. The waveform will be replayed after the ARB operation is finished.</p>
Initial S/W Revision	A.05.00

Delete All From ARB Memory

Allows you to remove all segments from ARB playback memory.

Key Path	Source, Modulation Setup, ARB, Select Waveform, Segments in ARB Memory
----------	--

Remote Command	:SOURce:RADio:ARB:DELeTe:ALL
Example	:SOUR:RAD:ARB:DELeTe:ALL
Notes	<p>When in Sequence Analyzer mode and Include Source is Yes, an attempt to delete all files from ARB memory is rejected with an error.</p> <p>When Include Source is No and you attempt to delete all files from ARB memory when the ARB is currently playing a file, all files except the one playing are deleted and an error is generated.</p> <p>If you attempt to delete all files from ARB memory when there are waveform files used in "List Sequencer" on page 2168 and "Sequencer" on page 2168 state is ON, all files except the files currently being used in list sequencer are deleted, and an error is generated.</p> <p>If the ARB is ON and you load a file to ARB memory or delete a file from ARB memory, the playing waveform segment may not keep phase continuity during the ARB memory operation. The waveform will be replayed after the ARB operation is finished.</p>
Initial S/W Revision	A.05.00

ARB Setup

Allows access to the ARB setup sub-menus.

Key Path	Source, Modulation Setup, ARB
Initial S/W Revision	A.05.00

Sample Rate

Allows you to set the ARB waveform playback sample rate.

Key Path	Source, Modulation Setup, ARB, ARB Setup
Remote Command	:SOURce:RADio:ARB:SCLock:RATE <freq> :SOURce:RADio:ARB:SCLock:RATE?
Example	:SOUR:RAD:ARB:SCL:RATE 48.00 MHz
Notes	If there is a sample rate specified in the header of the waveform file, changing that sample rate is not recommended, as it may cause problems with burst timing.
Dependencies	When a new waveform is selected for playback the settings contained within the associated waveform header file are applied to the ARB. The sample rate is one of the values stored within the header file. If the newly selected waveform file has an associated header file, the sample rate is updated with the value from the header file. The sample rate will remain unchanged if the newly selected waveform does not have an associated header file.
Preset	125.00 MHz
Min	1.00 kHz
Max	125.00 MHz
Initial S/W Revision	A.05.00

Run-Time Scaling

Allows you to adjust the run-time scaling value. The run-time scaling value is applied in real-time while the waveform is playing.

Key Path	Source, Modulation Setup, ARB, ARB Setup
Remote Command	:SOURce:RADio:ARB:RSCaling <real> :SOURce:RADio:ARB:RSCaling?
Example	:SOUR:RAD:ARB:RSC 100.00
Notes	This setting cannot be set in E6640A/M9420A. Grey out on menu and the value is fixed at 70.00%.
Dependencies	When a new waveform is selected for playback the settings contained within the associated waveform header file are applied to the ARB. The run-time scaling is one of the values stored within the header file. If the newly selected waveform file has an associated header file, the run-time scaling is updated with the value from the header file. The run-time scaling will remain unchanged if the newly selected waveform does not have an associated header file.
Preset	70.00 %
Min	1.00 %
Max	100.00 %
Initial S/W Revision	A.05.00

Baseband Freq Offset

Allows you to adjust the value by which the baseband frequency is offset relative to the carrier.

Key Path	Source, Modulation Setup, ARB, ARB Setup
Remote Command	:SOURce:RADio:ARB:BASEband:FREQuency:OFFSet <freq> :SOURce:RADio:ARB:BASEband:FREQuency:OFFSet?
Example	:SOUR:RAD:ARB:BAS:FREQ:OFFS 0.00 Hz
Dependencies	When a new waveform is selected for playback the settings contained within the associated waveform header file are applied to the ARB. The baseband frequency offset is one of the values stored within the header file. If the newly selected waveform file has an associated header file, the baseband frequency offset is updated with the value from the header file. The baseband frequency offset will remain unchanged if the newly selected waveform does not have an associated header file.
Preset	0.00 Hz
Min	-50.00 MHz
Max	50.00 MHz
Initial S/W Revision	A.05.00

Edit RMS

Allows you to edit or calculate current RMS of selected waveform.

Key Path	Source, Modulation Setup, ARB, ARB Setup
Initial S/W Revision	A.14.50

Current RMS

Allows you to directly specify current RMS value used to playback currently selected waveform. Please note incorrect RMS value may cause inaccurate power output in E6640A/M9420A that is sensitive to RMS value.

This setting is also updated by RMS in waveform header or updated when invoking RMS calculation operation.

This setting can be saved to the header of currently selected waveform by invoking ["Save Setup To Header" on page 2164](#) "Save Setup To Header".

Key Path	Source, Modulation Setup, ARB, ARB Setup, Edit RMS
Remote Command	:SOURce:RADio:ARB:RMS <float> :SOURce:RADio:ARB:RMS?
Example	:SOUR:RAD:ARB:HEAD:RMS 0.7 :SOUR:RAD:ARB:HEAD:RMS?
Notes	Valid range is 0 to 1.414, values outside the range will be clipped to the closest boundary. Note this value does not affect "List Sequencer" on page 2168 Source List Sequencer that always uses RMS value resides in each ARB header. If want this value to take effect in list sequencer, use "Save Setup To Header" on page 2164 "Save Setup to Header" to save current RMS value to header first, then play the ARB in source list sequencer.
Dependencies	When a new waveform is selected for playback, this setting is updated by the RMS value defined in associated waveform header file. If selected waveform has no associated header file or header file does not specify RMS value, then instrument will try to calculate out one automatically. Calculating RMS can also update this setting.
Preset	0
Range	0 ~ 1.414
Initial S/W Revision	A.14.50

RMS Calculation Mode

Allows you to specify the mode to calculate the current RMS.

Key Path	Source, Modulation Setup, ARB, ARB Setup, Edit RMS
Remote Command	:SOURce:RADio:ARB:RMS:CALCulation:MODE AUTO M1 M2 M3 M4 :SOURce:RADio:ARB:RMS:CALCulation:MODE?
Example	:SOUR:RAD:ARB:RMS:CALC:MODE AUTO
Notes	If no waveform is selected, or selected waveform is waveform sequence, the key will grey out.

Preset	AUTO
Range	AUTO M1 M2 M3 M4
Initial S/W Revision	A.14.50

Auto

RMS will be calculated based on the whole sample range of current selected waveform.

Key Path	Source, Modulation Setup, ARB, ARB Setup, Edit RMS, Calculate RMS, RMS Calculation Mode
Example	:SOUR:RAD:ARB:RMS:CALC:MODE AUTO
Initial S/W Revision	A.14.50

Marker 1

Selects marker 1 to designate sample range used for RMS calculation.

Key Path	Source, Modulation Setup, ARB, ARB Setup, Edit RMS, Calculate RMS, RMS Calculation Mode , Marker
Example	:SOUR:RAD:ARB:RMS:CALC:MODE M1
Initial S/W Revision	A.14.50

Marker 2

Selects marker 2 to designate sample range used for RMS calculation.

Key Path	Source, Modulation Setup, ARB, ARB Setup, Edit RMS, Calculate RMS, RMS Calculation Mode , Marker
Example	:SOUR:RAD:ARB:RMS:CALC:MODE M2
Initial S/W Revision	A.14.50

Marker 3

Selects marker 3 to designate sample range used for RMS calculation.

Key Path	Source, Modulation Setup, ARB, ARB Setup, Edit RMS, Calculate RMS, RMS Calculation Mode , Marker
Example	:SOUR:RAD:ARB:RMS:CALC:MODE M3
Initial S/W Revision	A.14.50

Marker 4

Selects marker 4 to designate sample range used for RMS calculation.

Key Path	Source, Modulation Setup, ARB, ARB Setup, Edit RMS, Calculate RMS, RMS Calculation Mode , Marker
Example	:SOUR:RAD:ARB:RMS:CALC:MODE M4
Initial S/W Revision	A.14.50

Calculate RMS

Allows you to calculate current RMS based on mode selected. This will update "[Current RMS](#)" on page 2137 Current RMS setting.

Key Path	Source, Modulation Setup, ARB, ARB Setup, Edit RMS, Calculate RMS
Remote Command	:SOURce:RADio:ARB:RMS:CALCulate
Example	:SOUR:RAD:ARB:RMS:CALC
Notes	<p>If no waveform is selected, invoking this operation will get error “-221 Setting conflict; No waveform is selected for RMS operation”.</p> <p>If no waveform is selected, or selected waveform is waveform sequence, the key will grey out.</p> <p>If selected waveform does not contain marker data, but "RMS Calculation Mode" on page 2137 “RMS Calculation Mode” is set to marker, under this circumstance, invoking calculation operation will get error “-221 Setting conflict; There is no marker for currently selected waveform, auto RMS calculation mode is used instead”, and "RMS Calculation Mode" on page 2137 “RMS Calculation Mode” will be coupled to “Auto” mode automatically.</p> <p>RMS calculation does not suit for waveform sequence. If selected waveform is waveform sequence file, invoking this operation will get error “-221 Setting conflict; RMS calculation does not apply to waveform sequence”. But users can still edit current RMS as play parameter, and can save current RMS to waveform sequence header for later use.</p>
Initial S/W Revision	A.14.50

Use Header RMS

Allows you to quickly set RMS in ARB header to "[Current RMS](#)" on page 2137 Current RMS setting.

Key Path	Source, Modulation Setup, ARB, ARB Setup, Edit RMS,
Notes	<p>No remote command, front panel only.</p> <p>If no waveform is selected, the key will grey out.</p> <p>If no waveform is selected, invoking this operation will get error “-221 Setting conflict; No waveform is selected for RMS operation”.</p>
Initial S/W Revision	A.14.50

Trigger Type

Allows access to the trigger type sub-menus. The setting for trigger type determines the behavior of the waveform when it plays.

Key Path	Source, Modulation Setup, ARB
Remote Command	:SOURce:RADio:ARB:TRIGger:TYPE CONTInuous SINGle SADVance :SOURce:RADio:ARB:TRIGger:TYPE?
Example	:SOUR:RAD:ARB:TRIG:TYPE CONT :SOUR:RAD:ARB:TRIG:TYPE?
Notes	Gated trigger type will be implemented at a later release
Preset	CONTInuous
Range	Continuous Single Seg Adv
Initial S/W Revision	A.05.00

Continuous

Sets the active trigger type to Continuous. If Continuous is already selected as the active trigger type, pressing this key allows access to the continuous trigger type setup menu. In Continuous trigger mode, the waveform repeats continuously.

Key Path	Source, Modulation Setup, ARB, Trigger Type
Remote Command	:SOURce:RADio:ARB:TRIGger:TYPE:CONTInuous[:TYPE] FREE TRIGger RESet :SOURce:RADio:ARB:TRIGger:TYPE:CONTInuous[:TYPE]?
Example	:SOUR:RAD:ARB:TRIG:TYPE:CONT FREE
Preset	FREE
Range	Free Run Trigger + Run Reset + Run
Initial S/W Revision	A.05.00

Free Run

Selects Free Run as the trigger response for the continuous trigger type. Free Run sets the waveform generator to play a waveform sequence or segment continuously, without waiting for a trigger. In this mode, the waveform generator does not respond to triggers.

Key Path	Source, Modulation Setup, ARB, Trigger Type, Continuous
Example	:SOUR:RAD:ARB:TRIG:TYPE:CONT FREE
Initial S/W Revision	A.05.00

Trigger + Run

Sets Trigger and Run as the trigger response for the continuous trigger type. Trigger and Run sets the waveform generator to play a waveform sequence or segment continuously when the first trigger is received, and to ignore any subsequent triggers.

Key Path	Source, Modulation Setup, ARB, Trigger Type, Continuous
Example	:SOUR:RAD:ARB:TRIG:TYPE:CONT TRIG
Initial S/W Revision	A.05.00

Reset + Run

Sets Reset and Run as the trigger response for the continuous trigger type. Reset and Run sets the waveform generator to play a waveform sequence or segment continuously when the first trigger is received. Subsequent triggers reset the waveform sequence or segment to the start, and then play it continuously.

Key Path	Source, Modulation Setup, ARB, Trigger Type, Continuous
Example	:SOUR:RAD:ARB:TRIG:TYPE:CONT RES
Initial S/W Revision	A.05.00

Single

Sets the active trigger type to Single. If Single is already selected as the active trigger type, pressing this key allows access to the single trigger type setup menu. In Single trigger mode, the waveform plays once.

Key Path	Source, Modulation Setup, ARB, Trigger Type
Remote Command	:SOURce:RADio:ARB:RETRigger ON OFF IMMediate :SOURce:RADio:ARB:RETRigger?
Example	:SOUR:RAD:ARB:RETR OFF
Notes	ON: Buffered Trigger OFF: No Retrigger Immediate: Restart on Trigger This is defined as an enumerated SCPI command, with ON OFF being considered as enumerated types rather than Boolean. This means the query will return OFF instead of 0, and ON instead of 1.
Preset	ON
Range	No Retrigger Buffered Trigger Restart on Trigger
Initial S/W Revision	A.05.00

No Retrigger

Selects No Retrigger as the trigger response for single trigger type. No Retrigger sets the waveform generator to play a waveform sequence or segment once when a trigger is received. Any triggers then

received during playback are ignored.

Key Path	Source, Modulation Setup, ARB, Trigger Type, Single
Example	:SOUR:RAD:ARB:RETR OFF
Initial S/W Revision	A.05.00

Buffered Trigger

Selects Buffered Trigger as the trigger response for single trigger type. Buffered Trigger sets the waveform generator to play a waveform sequence or segment once when a trigger is received. If a trigger is received during playback, the waveform generator plays the sequence or segment to the end, then plays the sequence or segment once more.

Key Path	Source, Modulation Setup, ARB, Trigger Type, Single
Example	:SOUR:RAD:ARB:RETR ON
Initial S/W Revision	A.05.00

Restart on Trigger

Selects Restart on Trigger as the trigger response for single trigger type. Restart on Trigger sets the waveform generator to play a waveform sequence or segment once when a trigger is received. If a trigger is received during playback, the waveform generator resets and plays the sequence or segment from the start.

Key Path	Source, Modulation Setup, ARB, Trigger Type, Single
Example	:SOUR:RAD:ARB:RETR IMM
Initial S/W Revision	A.05.00

Segment Advance

Sets the active trigger type to Segment Advance. If Segment Advance is already selected as the active trigger type, pressing this key allows access to the segment advance trigger type setup menu.

Segment Advance triggering allows you to control the playback of waveform segments within a waveform sequence. When a trigger is received the ARB advances to the next waveform segment within the waveform sequence. This type of triggering ignores the repetition count for the waveform segment within the waveform sequence. For example, if a waveform segment has a repetition count of 10 and you select single segment advance triggering mode, the waveform segment will only play once.

Segment Advance triggering can also be used for waveform segments only. In this situation the same waveform segment is played again when a trigger is received.

Key Path	Source, Modulation Setup, ARB, Trigger Type
Remote Command	:SOURce:RADio:ARB:TRIGger:TYPE:SADVance[:TYPE] SINGLE CONTInuous

	:SOURce:RADio:ARB:TRIGger:TYPE:SADVance[:TYPE]?
Example	:SOUR:RAD:ARB:TRIG:TYPE:SADV SING
Preset	CONTInuous
Range	Single Continuous
Initial S/W Revision	A.05.00

Single

Selects Single as the trigger response for Segment Advance trigger type. With single selected, once a trigger is received a segment is played once. If a trigger is received during playback of a segment, the segment plays to completion and the next segment is played once.

Key Path	Source, Modulation Setup, ARB, Trigger Type, Segment Advance
Example	:SOUR:RAD:ARB:TRIG:TYPE:SADV SING
Initial S/W Revision	A.05.00

Continuous

Selects Continuous as the trigger response for Segment Advance trigger type. With continuous selected, once a trigger is received a segment is played continuously. When subsequent triggers are received, the currently playing segment plays to completion and then the next segment is played continuously.

Key Path	Source, Modulation Setup, ARB, Trigger Type, Segment Advance
Example	:SOUR:RAD:ARB:TRIG:TYPE:SADV CONT
Initial S/W Revision	A.05.00

ARB

Allows you access to the ARB sub-menus.

Key Path	Source, Modulation Setup
Initial S/W Revision	A.05.00

Trigger Source

The trigger source setting determines how the source receives the trigger that starts the waveform playing. Therefore, this key is grayed out if the trigger type is free run, since free run triggers immediately with no trigger source required.

Key Path	Source, Modulation Setup, ARB
Remote Command	:SOURce:RADio:ARB:TRIGger[:SOURce] KEY BUS EXTeRnal2

	:SOURce:RADio:ARB:TRIGger[:SOURce]?
Example	:SOUR:RAD:ARB:TRIGger KEY
Dependencies	This key is grayed out if the current trigger type is Continuous, Free Run.
Preset	EXTernal2
Range	Trigger Key Bus External 2
Initial S/W Revision	A.05.00

Trigger Key

Sets the current trigger source to the front panel Trigger key. When Trigger Key is selected, the waveform is triggered when you press the front panel Trigger key.

Key Path	Source, Modulation Setup, ARB, Trigger Source
Example	:SOUR:RAD:ARB:TRIGger KEY
Initial S/W Revision	A.05.00

Bus

Sets the current trigger source to Bus. Selecting Bus trigger source enables triggering over GPIB, LAN, or USB using the :SOURce:RADio:ARB:TRIGger:INITiate command.

Key Path	Source, Modulation Setup, ARB, Trigger Source
Example	:SOUR:RAD:ARB:TRIGger BUS
Initial S/W Revision	A.05.00

External 2

Sets the current trigger source to External 2. Selecting External 2 enables triggering a waveform by an externally applied signal.

Key Path	Source, Modulation Setup, ARB, Trigger Source
Example	:SOUR:RAD:ARB:TRIGger EXT2
Notes	Note: When on E6640A, trigger 2 is a bi-directional trigger port. So when trigger 2 has been configured as OUTPUT type, choosing External 2 as the input trigger for the current step will generate error.
Initial S/W Revision	A.05.00

External Trigger Delay

This key allows you to toggle the state and value of external trigger delay. The value you enter sets a delay time between when an external trigger is received and when it is applied to the waveform. This is key is

active only if you select external trigger as trigger source.

Key Path	Source, Modulation Setup, ARB, Trigger Source
Remote Command	:SOURce:RADio:ARB:TRIGger[:SOURce]:EXTErnal:DELay <time> :SOURce:RADio:ARB:TRIGger[:SOURce]:EXTErnal:DELay? SOURce:RADio:ARB:TRIGger[:SOURce]:EXTErnal:DELay:STATe OFF ON 0 1 :SOURce:RADio:ARB:TRIGger[:SOURce]:EXTErnal:DELay:STATe?
Example	:SOUR:RAD:ARB:TRIG:EXT:DEL 100ns :SOUR:RAD:ARB:TRIG:EXT:DEL? :SOUR:RAD:ARB:TRIG:EXT:DEL:STAT ON :SOUR:RAD:ARB:TRIG:EXT:DEL:STAT?
Notes	External trigger delay time set by users will be rounded to the nearest integer multiple of the resolution.
Dependencies	This setting is unavailable and is grayed out when the Trigger Source is not set to external trigger.
Preset	1 ms OFF
Min	0 s
Max	8.589934588 s (Note: This value comes from $4\text{ns} * (2^{31} - 1) = 8589934588\text{ ns}$)
Initial S/W Revision	A.14.50

Trigger Initiate

Used to initiate an immediate trigger event if the trigger source is set to Trigger Key.

Key Path	Source, Modulation Setup, ARB
Notes	No remote command, SCPI front panel only.
Initial S/W Revision	A.05.00

Waveform Sequences

Allows access to the waveform sequence sub-menus. Pressing this key changes the central view area to display the Waveform Sequence List view.

Key Path	Source, Modulation Setup, ARB
Notes	No remote command, SCPI front panel only.
Initial S/W Revision	A.05.00

Build New Sequence

Allows access to the sub-menus for creating a new waveform sequence. Pressing this key changes the central view area to display the Waveform Sequence Creation and Editing view.

Key Path	Source, Modulation Setup, ARB, Waveform Sequences
Notes	No remote command, SCPI front panel only.
Initial S/W Revision	A.05.00

Current Segment

Specifies the selected sequence segment that will be affected by the menu functions.

Key Path	Source, Modulation Setup , ARB, Waveform Sequences, Build New Sequence
Notes	No remote command, SCPI front panel only. This key is grayed out and unavailable if the sequence is currently empty.
Initial S/W Revision	A.05.00

Insert New Waveform

Allows you access to the sub-menu for inserting a new waveform segment or sequence. Pressing this key also changes the central display to show the Waveform File Selection View.

Key Path	Source, Modulation Setup, ARB, Waveform Sequences, Build New Sequence
Notes	No remote command, SCPI front panel only. Waveform segment name string length upper limit is 128 chars. Please do NOT insert waveform which name string exceeds 128 chars.
Initial S/W Revision	A.05.00

Insert Waveform

Inserts the currently highlighted waveform to the end of the waveform sequence. Pressing this key also returns you to the menus for creating or editing a sequence, and returns the central view to the sequence creation view.

Key Path	Source, Modulation Setup, ARB, Waveform Sequences, Build New Sequence, Insert New Waveform
Notes	No remote command, SCPI front panel only. Waveform segment name string length upper limit is 128 chars. Please do NOT insert waveform which name string exceeds 128 chars.
Initial S/W Revision	A.05.00

Segments on Hard Disk

Allows you access to the sub-menus for loading waveform segments from the hard disk into ARB memory. The default directory is: D: varb.

Pressing this key changes the current view to the Waveform Management View.

Key Path	Source, Modulation Setup, ARB, Select Waveform
Initial S/W Revision	A.05.00

Load Segment To ARB Memory

Allows you to load the selected file into ARB memory. On the front panel you select the file for loading to the ARB memory by highlighting the desired file in the list. Using the SCPI command, you specify the file name on the HDD.

“NVWFM” (none-volatile storage) MSUS (Mass Storage Unit Specifier) is supported in the memory subsystem because the ARB memory cannot be accessed directly. Therefore, files must be downloaded to the instrument hard disk and then loaded into the ARB memory. “NVWFM” MSUS will be mapped to the default directory D: VARB. The SCPI command supports using either “NVWFM” MSUS or specifying a full path. For more information, see Memory Subsystem (Remote Command Only).

If a file of the same name already exists within ARB memory, it is overwritten. If you wish to load two segments of the same name, you must rename one of the segments before loading it into ARB memory. To rename a segment, you can either use Windows File Explorer, or the :MMEMory:COPI command.

NOTE: When a waveform file is loaded to ARB memory, burst timing adjustments are made automatically, based on whether or not a Multiport Adapter is connected to the test set and powered on. If the connection/power status of the Multiport Adapter is changed after a waveform file has been loaded, it needs to be loaded again.

Key Path	Source, Modulation Setup, ARB, Select Waveform, Segments on Hard Disk
Remote Command	:SOURce:RADio:ARB:LOAD <string>
Example	:SOUR:RAD:ARB:LOAD "D: VARB\testwaveform.bin" or :SOUR:RAD:ARB:LOAD "NVWFM:testwaveform.bin"
Notes	<p>Because loading the file involves a delay of unpredictable length, this command should be followed by the query *OPC?, which holds off subsequent commands until the loading operating is complete.</p> <p><string> – specifies the path name of the file to load from the HDD into ARB memory. It could be a <full path + filename>, or <"NVWFM" MSUS + colon + filename>.</p> <p>When in Sequence Analyzer mode, and Include Source is Yes, an attempt to load a file to ARB memory will be rejected with an error.</p> <p>When Include Source is No and if there is insufficient free ARB memory to load the selected waveform, an error is generated. .</p> <p>If you specify a file over SCPI, but the file is not at the specified location, an error is generated.</p> <p>If you try to load a waveform file but the file contains less than 500 IQ samples, an error is generated.</p> <p>If you try to load a Signal Studio waveform "*.wfm" which contains invalid waveform header, an error is generated.</p>

If the ARB is ON when you load a file to ARB memory or delete a file from ARB memory, the playing waveform segment may not keep phase continuity during the ARB memory operation. The waveform will be replayed after the ARB operation is finished.

ARB can be loaded into ARB memory even if required licenses do not present on the instrument. In this case, a GUI only warning message -800, "Operation complete; Loaded <filename> successfully, but no license <required licenses> installed". User can install required licenses according to <required licenses> string to license it, or multi-pack license it.

Initial S/W Revision	A.05.00
----------------------	---------

Load All To ARB Memory

Allows you to load all the segment files within the currently selected directory into ARB memory. If a file of the same name already exists within ARB memory, it is overwritten. If you wish to load two segments of the same name, you must rename one of the segments before loading it into ARB memory. To rename a segment, you can either use Windows File Explorer, or the :MEMORY:COPY command.

NOTE: When a waveform file is loaded to ARB memory, burst timing adjustments are made automatically, based on whether or not a Multiport Adapter is connected to the test set and powered on. If the connection/power status of the Multiport Adapter is changed after a waveform file has been loaded, it needs to be loaded again.

Key Path	Source, Modulation Setup, ARB, Select Waveform, Segments on Hard Disk
Remote Command	:SOURce:RADio:ARB:LOAD:ALL <string>
Example	:SOUR:RAD:ARB:LOAD:ALL "D: varb"
Notes	<p><string> - specifies the directory on the HDD to load the files into ARB memory from.</p> <p>When in Sequence Analyzer mode, and Include Source is Yes, an attempt to load all files from a directory to ARB memory is rejected with an error.</p> <p>When Include Source is No and there is insufficient free ARB memory to load all the waveforms, when the ARB memory is full, the copy ceases, and an error is generated.</p> <p>If you specify a directory over SCPI, but the directory does not exist, an error is generated.</p> <p>If the ARB is ON, a user then loads or deletes file to ARB memory, the playing waveform segment may not keep phase continuity during the ARB memory operation. The waveform will be replayed after the ARB operation is finished.</p>
Initial S/W Revision	A.05.00

Change Directory...

Allows you to change the currently selected directory on the hard disk. Pressing this key opens a standard windows change directory dialog allowing you to select the new directory of interest.

The current directory is used for manually loading waveform segments into ARB memory for playback, and as a search location for waveform segments that are required to be loaded into ARB memory for playback of a waveform sequence or a list sequence.

Key Path	Source, Modulation Setup, ARB, Select Waveform, Segments on Hard Disk
Notes	No remote command, SCPI front panel only.
Initial S/W Revision	A.05.00

Default Directory...

Allows you to change the default directory. It is used as a search location for waveform segments that are required to be loaded into ARB memory for playback of a waveform sequence, and as a search location for selecting waveforms using SCPI.

Key Path	Source, Modulation Setup, ARB, Select Waveform, Segments on Hard Disk
Remote Command	:SOURce:RADio:ARB:DEFault:DIRectory <string> :SOURce:RADio:ARB: DEFault:DIRectory?
Example	:SOUR:RAD:ARB:DEF:DIR "D:\ArbFiles" :SOUR:RAD:ARB:DEF:DIR?
State Saved	Persistent, survives a power cycle and a preset but not saved in the instrument state
Initial S/W Revision	A.05.00

Segments in ARB Memory

Allows you access to the sub-menus for managing the files within ARB memory.

Key Path	Source, Modulation Setup, ARB, Select Waveform
Initial S/W Revision	A.05.00

Delete Segment From ARB Mem

Allows you to remove a segment from ARB playback memory.

Key Path	Source, Modulation Setup, ARB, Select Waveform, Segments in ARB Memory
Remote Command	:SOURce:RADio:ARB:DELete <string>
Example	:SOUR:RAD:ARB:DEL "testwaveform.bin"
Notes	<string> - specifies the waveform to be deleted from the ARB playback memory. When in Sequence Analyzer mode and Include Source is Yes, an attempt to delete a file from ARB memory is rejected with an error. When Include Source is No and you specify a file that does not exist within ARB memory, an error is generated. It is possible to delete files from within the ARB memory when the ARB is ON. However, if you attempt to delete the file that is currently playing an error is generated. It is possible to delete a file from within the ARB memory when the sequencer state is ON and the file is not being used by the List Sequencer. If you attempt to delete a file which is being used by the list

sequencer, an error is generated.

When sequencer state is On, even if ARB state is On, the selected waveform will not be played. In this case, if the selected waveform is not used in List Sequence, it can be deleted and the ARB state is turned Off.

If the ARB is ON and you load a file to ARB memory or delete a file from ARB memory, the playing waveform segment may not keep phase continuity during the ARB memory operation. The waveform will be replayed after the ARB operation is finished.

Initial S/W Revision A.05.00

Delete All From ARB Memory

Allows you to remove all segments from ARB playback memory.

Key Path	Source, Modulation Setup, ARB, Select Waveform, Segments in ARB Memory
Remote Command	:SOURce:RADio:ARB:DELeTe:ALL
Example	:SOUR:RAD:ARB:DELeTe:ALL
Notes	<p>When in Sequence Analyzer mode and Include Source is Yes, an attempt to delete all files from ARB memory is rejected with an error.</p> <p>When Include Source is No and you attempt to delete all files from ARB memory when the ARB is currently playing a file, all files except the one playing are deleted and an error is generated.</p> <p>If you attempt to delete all files from ARB memory when there are waveform files used in "List Sequencer" on page 2168 and "Sequencer" on page 2168 state is ON, all files except the files currently being used in list sequencer are deleted, and an error is generated.</p> <p>If the ARB is ON and you load a file to ARB memory or delete a file from ARB memory, the playing waveform segment may not keep phase continuity during the ARB memory operation. The waveform will be replayed after the ARB operation is finished.</p>

Initial S/W Revision A.05.00

Edit Selected Waveform

Allows access to the sub-menus for editing the details of the currently selected waveform segment.

Key Path	Source, Modulation Setup, ARB, Waveform Sequences, Build New Sequence
Notes	No remote command, front panel only.
Initial S/W Revision	A.05.00

Repetitions

Allows you to specify the number of times the currently selected waveform is played within the sequence.

Key Path	Source, Modulation Setup, ARB, Waveform Sequences, Build New Sequence, Edit Selected Waveform
----------	---

Notes	No remote command, SCPI front panel only.
Preset	1
Min	1
Max	65535
Initial S/W Revision	A.05.00

Marker 1

Allows you to enable or disable marker 1 for the currently selected waveform. For a waveform sequence, you can enable and disable markers on a per-segment basis, allowing you to output markers from some waveform segments within the sequence, but not for others.

Key Path	Source, Modulation Setup, ARB, Waveform Sequences, Build New Sequence, Edit Selected Waveform
Notes	No remote command, front panel only.
Preset	Enabled
Range	Enabled Disabled
Initial S/W Revision	A.05.00

Marker 2

Allows you to enable or disable marker 2 for the currently selected waveform. For a waveform sequence, you can enable and disable markers on a per-segment basis, allowing you to output markers from some waveform segments within the sequence, but not for others.

Key Path	Source, Modulation Setup, ARB, Waveform Sequences, Build New Sequence, Edit Selected Waveform
Notes	No remote command, front panel only.
Preset	Enabled
Range	Enabled Disabled
Initial S/W Revision	A.05.00

Marker 3

Allows you to enable or disable marker 3 for the currently selected waveform. For a waveform sequence, you can enable and disable markers on a per-segment basis, allowing you to output markers from some waveform segments within the sequence, but not for others.

Key Path	Source, Modulation Setup, ARB, Waveform Sequences, Build New Sequence, Edit Selected Waveform
----------	---

Notes	No remote command, front panel only.
Preset	Enabled
Range	Enabled Disabled
Initial S/W Revision	A.05.00

Marker 4

Allows you to enable or disable marker 4 for the currently selected waveform. For a waveform sequence, you can enable and disable markers on a per-segment basis, allowing you to output markers from some waveform segments within the sequence, but not for others.

Key Path	Source, Modulation Setup, ARB, Waveform Sequences, Build New Sequence, Edit Selected Waveform
Notes	No remote command, front panel only.
Preset	Enabled
Range	Enabled Disabled
Initial S/W Revision	A.05.00

Delete Segment

Allows you to delete the selected segment from the waveform sequence.

Key Path	Source, Modulation Setup, ARB, Waveform Sequences, Build New Sequence
Notes	No remote command, front panel only.
Initial S/W Revision	A.05.00

Save Sequence...

Pressing this key displays the “Save As” dialog. The sequence name is passed to the save as dialog to use as the filename for saving, and the directory the save as dialog will open into is the default waveform directory.

Key Path	Source, Modulation Setup, ARB, Waveform Sequences, Build New Sequence
Initial S/W Revision	A.05.00

Edit Selected Sequence

Allows access to the sub-menus for editing the sequence currently selected within the Waveform Sequence List view. Pressing this key changes the central view area to display the Waveform Sequence Creation and Editing view.

Key Path	Source, Modulation Setup, ARB, Waveform Sequences
Notes	No remote command, front panel only.
Initial S/W Revision	A.05.00

Current Directory...

Allows you to change the currently selected directory on the hard disk. Pressing this key opens a standard windows change directory dialog and allows you to select the new directory of interest.

Key Path	Source, Modulation Setup, ARB, Waveform Sequences
Notes	No remote command, front panel only.
Initial S/W Revision	A.05.00

Waveform Utilities

Allows you access to the waveform utilities sub-menus.

Key Path	Source, Modulation Setup, ARB
Initial S/W Revision	A.05.00

Multi-Pack Licenses

Allows you access to the Multi - Pack License sub-menus. Pressing this key also changes the central view area to display the Multi -Pack License Management view.

On modular instrument like E6630A or E6640A, multi-pack license operations are only allowed on the default module, i.e. "Left" module for E6630A or "TRX1" module for E6640A.

Key Path	Source, Modulation Setup, ARB, Waveform Utilities
Dependencies	This key is only available if there is at least one Multi-pack license installed on the instrument.
Initial S/W Revision	A.05.00

Add Waveform

Pressing this key accesses the Add Waveform sub-menu. It also changes the central display area to display the Multi-Pack License Waveform Add view.

Key Path	Source, Modulation Setup, ARB, Waveform Utilities, Multi-Pack Licenses
Dependencies	This key is only available if there is at least one slot available within at least one multi-pack license.
Initial S/W Revision	A.05.00

Add Waveform

Allows you to add the currently selected waveform segment to a multi-pack license. The new waveform is added to the next available slot regardless of which slot was selected on the Multi-Pack License Management view.

Key Path	Source, Modulation Setup, ARB, Waveform Utilities, Multi-Pack Licenses, Add Waveform
Remote Command	:SYSTem:LKEY:WAVeform:ADD <string> or :SYSTem:LIcense[:FPACK]:WAVeform:ADD <string>
Example	SYST:LKEY:WAV:ADD "mywaveform.wfm" or SYST:LIC:WAV:ADD "mywaveform.wfm"
Notes	The second SCPI :SYSTem:LIcense[:FPACK]:WAVeform:ADD is provided to be consistent with the style of Keysight signal sources. You can use either one of them. Since adding a waveform segment to a Multi-Pack license causes the license slot to enter the trial period of only 48 hours, pressing this key causes a confirmation dialog to be displayed to ensure you do want to add the waveform segment to the Multi-Pack. If you attempt to license a waveform that is already licensed using another slot an error is generated. .
Dependencies	This key is only available if the currently selected file is a secure waveform requiring a license, and there is at least one slot available within at least one multi-pack license. If the waveform highlighted is a secure waveform, but is already licensed, this key will be unavailable.
Initial S/W Revision	A.05.00

Segments on Hard Disk

Allows you access to the sub-menus for loading waveform segments from the hard disk into ARB memory. The default directory is: D: varb.

Pressing this key changes the current view to the Waveform Management View.

Key Path	Source, Modulation Setup, ARB, Select Waveform
Initial S/W Revision	A.05.00

Load Segment To ARB Memory

Allows you to load the selected file into ARB memory. On the front panel you select the file for loading to the ARB memory by highlighting the desired file in the list. Using the SCPI command, you specify the file name on the HDD.

"NVWFM" (none-volatile storage) MSUS (Mass Storage Unit Specifier) is supported in the memory subsystem because the ARB memory cannot be accessed directly. Therefore, files must be downloaded to the instrument hard disk and then loaded into the ARB memory. "NVWFM" MSUS will be mapped to the

default directory D: VARB. The SCPI command supports using either “NVWFM” MSUS or specifying a full path. For more information, see Memory Subsystem (Remote Command Only).

If a file of the same name already exists within ARB memory, it is overwritten. If you wish to load two segments of the same name, you must rename one of the segments before loading it into ARB memory. To rename a segment, you can either use Windows File Explorer, or the :MMEMory:COPI command.

NOTE: When a waveform file is loaded to ARB memory, burst timing adjustments are made automatically, based on whether or not a Multiport Adapter is connected to the test set and powered on. If the connection/power status of the Multiport Adapter is changed after a waveform file has been loaded, it needs to be loaded again.

Key Path	Source, Modulation Setup, ARB, Select Waveform, Segments on Hard Disk
Remote Command	:SOURce:RADio:ARB:LOAD <string>
Example	:SOUR:RAD:ARB:LOAD "D: VARB\testwaveform.bin" or :SOUR:RAD:ARB:LOAD "NVWFM:testwaveform.bin"
Notes	<p>Because loading the file involves a delay of unpredictable length, this command should be followed by the query *OPC?, which holds off subsequent commands until the loading operating is complete.</p> <p><string> – specifies the path name of the file to load from the HDD into ARB memory. It could be a <full path + filename>, or <“NVWFM” MSUS + colon + filename>.</p> <p>When in Sequence Analyzer mode, and Include Source is Yes, an attempt to load a file to ARB memory will be rejected with an error.</p> <p>When Include Source is No and if there is insufficient free ARB memory to load the selected waveform, an error is generated. .</p> <p>If you specify a file over SCPI, but the file is not at the specified location, an error is generated.</p> <p>If you try to load a waveform file but the file contains less than 500 IQ samples, an error is generated.</p> <p>If you try to load a Signal Studio waveform “*.wfm” which contains invalid waveform header, an error is generated.</p> <p>If the ARB is ON when you load a file to ARB memory or delete a file from ARB memory, the playing waveform segment may not keep phase continuity during the ARB memory operation. The waveform will be replayed after the ARB operation is finished.</p> <p>ARB can be loaded into ARB memory even required licenses do not present on the instrument. In this case, a GUI only warning message –800, “Operation complete; Loaded <filename> successfully, but no license <required licenses> installed”. User can install required licenses according to <required licenses> string to license it, or multi-pack license it.</p>
Initial S/W Revision	A.05.00

Load All To ARB Memory

Allows you to load all the segment files within the currently selected directory into ARB memory. If a file of the same name already exists within ARB memory, it is overwritten. If you wish to load two segments of the same name, you must rename one of the segments before loading it into ARB memory. To rename a segment, you can either use Windows File Explorer, or the :MEMory:COPI command.

NOTE: When a waveform file is loaded to ARB memory, burst timing adjustments are made automatically, based on whether or not a Multiport Adapter is connected to the test set and powered on. If the

connection/power status of the Multiport Adapter is changed after a waveform file has been loaded, it needs to be loaded again.

Key Path	Source, Modulation Setup, ARB, Select Waveform, Segments on Hard Disk
Remote Command	:SOURce:RADio:ARB:LOAD:ALL <string>
Example	:SOUR:RAD:ARB:LOAD:ALL "D: varb"
Notes	<p><string> - specifies the directory on the HDD to load the files into ARB memory from.</p> <p>When in Sequence Analyzer mode, and Include Source is Yes, an attempt to load all files from a directory to ARB memory is rejected with an error.</p> <p>When Include Source is No and there is insufficient free ARB memory to load all the waveforms, when the ARB memory is full, the copy ceases, and an error is generated.</p> <p>If you specify a directory over SCPI, but the directory does not exist, an error is generated.</p> <p>If the ARB is ON, a user then loads or deletes file to ARB memory, the playing waveform segment may not keep phase continuity during the ARB memory operation. The waveform will be replayed after the ARB operation is finished.</p>
Initial S/W Revision	A.05.00

Change Directory...

Allows you to change the currently selected directory on the hard disk. Pressing this key opens a standard windows change directory dialog allowing you to select the new directory of interest.

The current directory is used for manually loading waveform segments into ARB memory for playback, and as a search location for waveform segments that are required to be loaded into ARB memory for playback of a waveform sequence or a list sequence.

Key Path	Source, Modulation Setup, ARB, Select Waveform, Segments on Hard Disk
Notes	No remote command, SCPIfront panel only.
Initial S/W Revision	A.05.00

Default Directory...

Allows you to change the default directory. It is used as a search location for waveform segments that are required to be loaded into ARB memory for playback of a waveform sequence, and as a search location for selecting waveforms using SCPI.

Key Path	Source, Modulation Setup, ARB, Select Waveform, Segments on Hard Disk
Remote Command	:SOURce:RADio:ARB:DEFault:DIRectory <string> :SOURce:RADio:ARB: DEFault:DIRectory?
Example	:SOUR:RAD:ARB:DEF:DIR "D:\ArbFiles" :SOUR:RAD:ARB:DEF:DIR?
State Saved	Persistent, survives a power cycle and a preset but not saved in the instrument state
Initial S/W Revision	A.05.00

Replace Waveform

Pressing this key accesses the Replace Waveform submenu. It also changes the central display area to display the Multi-Pack License Waveform Add view.

Key Path	Source, Modulation Setup, ARB, Waveform Utilities, Multi-Pack Licenses
Dependencies	This key is only available if the currently selected slot is in the trial state.
Initial S/W Revision	A.05.00

Replace Waveform

Allows you to replace the waveform in the currently selected slot with the waveform currently selected in the Multi-Pack License Waveform Add view.

Key Path	Source, Modulation Setup, ARB, Waveform Utilities, Multi-Pack Licenses, Replace Waveform
Remote Command	:SYSTem:LKEY:WAVeform:REPLace <int>, <string> or :SYSTem:LICense[:FPACK]:WAVeform:REPLace <int>, <string>
Example	SYST:LKEY:WAV:REPL 1, "myotherwaveform.wfm" or :SYST:LIC:WAV:REPL 1, "myotherwaveform.wfm"
Notes	The second SCPI :SYSTem:LICense[:FPACK]:WAVeform:REPLace is provided to be consistent with the style of Keysight signal sources. You can use either one of them. If you attempt to license a waveform that is already licensed using another slot an error is generated. Waveform slot number <int> is positive. If you attempt to input a slot number less than or equals 0, an error is generated.
Initial S/W Revision	A.05.00

Clear Waveform from Slot

Allows you to clear the waveform from the selected slot.

Key Path	Source, Modulation Setup, ARB, Waveform Utilities, Multi-Pack Licenses
Remote Command	:SYSTem:LKEY:WAVeform:CLEar <int> or :SYSTem:LICense[:FPACK]:WAVeform:CLEar <int>
Example	SYST:LKEY:WAV:CLE 1 or :SYST:LIC:WAV:CLE 1
Notes	The second SCPI :SYSTem:LICense[:FPACK]:WAVeform:CLEar is provided to be consistent with the style of Keysight signal sources. You can use either one of them. Waveform slot number <int> is positive. If you attempt to input a slot number less than or equals 0, an

error is generated.

Dependencies	This key is only available if the currently selected slot is in the trial state.
Initial S/W Revision	A.05.00

Lock Waveform in Slot

If the selected slot is in the trial state or the lock required state, the waveform that occupies the slot is locked and permanently licensed.

Key Path	Source, Modulation Setup, ARB, Waveform Utilities, Multi-Pack Licenses
Remote Command	:SYSTem:LKEY:WAVEform:LOCK <int> or :SYSTem:LICense[:FPACK]:WAVEform:LOCK <int>
Example	SYST:LKEY:WAV:LOCK 1 or SYST:LIC:WAV:LOCK 1
Notes	The second SCPI :SYSTem:LICense[:FPACK]:WAVEform:LOCK is provided to be consistent with the style of Keysight signal sources. You can use either one of them. Waveform slot number <int> is positive. If you attempt to input a slot number less than or equals 0, an error is generated.
Dependencies	This key is only available if the currently selected slot is in the trial state or the lock required state.
Initial S/W Revision	A.05.00

Marker Utilities

Allows access to the marker utilities sub-menus.

Key Path	Source, Modulation Setup, ARB
Initial S/W Revision	A.05.00

Marker Polarity

Allows access to the marker polarity sub-menu, which allows you to specify the polarity for the four markers. For a positive polarity, the marker signal is high during the marker points. For a negative marker polarity, the marker signal is high during the period of no marker points.

Key Path	Source, Modulation Setup, ARB, Marker Utilities
Initial S/W Revision	A.05.00

Mkr 1 Polarity

Allows you to set the polarity of marker 1.

Key Path	Source, Modulation Setup, ARB, Marker Utilities, Marker Polarity
Remote Command	:SOURce:RADio:ARB:MPOLarity:MARKer1 POSitive NEGative :SOURce:RADio:ARB:MPOLarity:MARKer1?
Example	:SOUR:RAD:ARB:MPOL:MARK1 NEG
Dependencies	When a new waveform is selected for playback the settings contained within the associated waveform header file are applied to the ARB. The marker polarity is one of the values stored within the header file. If the newly selected waveform file has an associated header file, the marker polarity is updated with the value from the header file. The marker polarity will remain unchanged if the newly selected waveform does not have an associated header file.
Preset	Pos
Range	Neg Pos
Initial S/W Revision	A.05.00

Mkr 2 Polarity

Allows you to set the polarity of marker 2.

Key Path	Source, Modulation Setup, ARB, Marker Utilities, Marker Polarity
Remote Command	:SOURce:RADio:ARB:MPOLarity:MARKer2 POSitive NEGative :SOURce:RADio:ARB:MPOLarity:MARKer2?
Example	:SOUR:RAD:ARB:MPOL:MARK2 NEG
Dependencies	When a new waveform is selected for playback the settings contained within the associated waveform header file are applied to the ARB. The marker polarity is one of the values stored within the header file. If the newly selected waveform file has an associated header file, the marker polarity is updated with the value from the header file. The marker polarity will remain unchanged if the newly selected waveform does not have an associated header file.
Preset	Pos
Range	Neg Pos
Initial S/W Revision	A.05.00

Mkr 3 Polarity

Allows you to set the polarity of marker 3.

Key Path	Source, Modulation Setup, ARB, Marker Utilities, Marker Polarity
Remote Command	:SOURce:RADio:ARB:MPOLarity:MARKer3 POSitive NEGative :SOURce:RADio:ARB:MPOLarity:MARKer3?
Example	:SOUR:RAD:ARB:MPOL:MARK3 NEG
Dependencies	When a new waveform is selected for playback the settings contained within the associated

	waveform header file are applied to the ARB. The marker polarity is one of the values stored within the header file. If the newly selected waveform file has an associated header file, the marker polarity is updated with the value from the header file. The marker polarity will remain unchanged if the newly selected waveform does not have an associated header file.
Preset	Pos
Range	Neg Pos
Initial S/W Revision	A.05.00

Mkr 4 Polarity

Allows you to set the polarity of marker 4.

Key Path	Source, Modulation Setup, ARB, Marker Utilities, Marker Polarity
Remote Command	:SOURce:RADio:ARB:MPOLarity:MARKer4 POSitive NEGative :SOURce:RADio:ARB:MPOLarity:MARKer4?
Example	:SOUR:RAD:ARB:MPOL:MARK4 NEG
Dependencies	When a new waveform is selected for playback the settings contained within the associated waveform header file are applied to the ARB. The marker polarity is one of the values stored within the header file. If the newly selected waveform file has an associated header file, the marker polarity is updated with the value from the header file. The marker polarity will remain unchanged if the newly selected waveform does not have an associated header file.
Preset	Pos
Range	Neg Pos
Initial S/W Revision	A.05.00

Marker Routing

Allows access to the marker routing sub-menus, which allow you to specify where the marker events are routed. It should be noted that the markers can also be routed to Trigger 1 Out and Trigger 2 Out, however this must be set up using the menus accessed by pressing the “Trigger” hard key.

Key Path	Source, Modulation Setup, ARB, Marker Utilities
Initial S/W Revision	A.05.00

Pulse/RF Blank

Allows you to select which marker is used for the pulse/RF blanking function. The pulse/RF blanking function blanks the RF when the marker signal goes low. The marker polarity determines when the marker signal is high. For a positive polarity, this is during the marker points. For a negative polarity, this is when there are no marker points.

Marker points should be set before using this function. Enabling this function without setting maker points may create a continuous low or high signal, dependant on the marker polarity. This causes either no RF output, or a continuous RF output.

Key Path	Source, Modulation Setup, ARB, Marker Utilities, Marker Routing
Remote Command	:SOURce:RADio:ARB:MDEStination:PULSe NONE M1 M2 M3 M4 :SOURce:RADio:ARB:MDEStination:PULSe?
Example	:SOUR:RAD:ARB:MDES:PULS NONE
Dependencies	When a new waveform is selected for playback the settings contained within the associated waveform header file are applied to the ARB. The pulse/RF blanking setting is one of the values stored within the header file. If the newly selected waveform file has an associated header file, the pulse/RF blanking setting is updated with the value from the header file. The pulse/RF blanking setting will remain unchanged if the newly selected waveform does not have an associated header file.
Range	None M1 M2 M3 M4
Initial S/W Revision	A.05.00

None

Sets no marker to be used for the pulse/RF blanking function, essentially turning the RF blanking function off.

Key Path	Source, Modulation Setup, ARB, Marker Utilities, Marker Routing, Pulse/RF Blank
Example	:SOUR:RAD:ARB:MDES:PULS NONE
Initial S/W Revision	A.05.00

Marker 1

Sets marker 1 to be used for the pulse/RF blanking function.

Key Path	Source, Modulation Setup, ARB, Marker Utilities, Marker Routing, Pulse/RF Blank
Example	:SOUR:RAD:ARB:MDES:PULS M1
Initial S/W Revision	A.05.00

Marker 2

Sets marker 2 to be used for the pulse/RF blanking function.

Key Path	Source, Modulation Setup, ARB, Marker Utilities, Marker Routing, Pulse/RF Blank
Example	:SOUR:RAD:ARB:MDES:PULS M2
Initial S/W Revision	A.05.00

Marker 3

Sets marker 3 to be used for the pulse/RF blanking function.

Key Path	Source, Modulation Setup, ARB, Marker Utilities, Marker Routing, Pulse/RF Blank
Example	:SOUR:RAD:ARB:MDES:PULS M3
Initial S/W Revision	A.05.00

Marker 4

Sets marker 4 to be used for the pulse/RF blanking function.

Key Path	Source, Modulation Setup, ARB, Marker Utilities, Marker Routing, Pulse/RF Blank
Example	:SOUR:RAD:ARB:MDES:PULS M4
Initial S/W Revision	A.05.00

ALC Hold

Allows you to specify which marker is routed for use within the ALC hold function. The ALC hold marker function holds the ALC circuitry at the average value of the sample points set by the marker.

The ALC hold function operates during the low periods of the marker signal. The marker polarity determines when the marker signal is high. For positive polarity, this is during the marker points. For a negative polarity, this is when there are no maker points.

Key Path	Source, Modulation Setup, ARB, Marker Utilities, Marker Routing
Remote Command	:SOURce:RADio:ARB:MDEStination:ALCHold NONE M1 M2 M3 M4 :SOURce:RADio:ARB:MDEStination:ALCHold?
Example	:SOUR:RAD:ARB:MDES:ALCH NONE
Dependencies	When a new waveform is selected for playback the settings contained within the associated waveform header file are applied to the ARB. The ALC hold setting is one of the values stored within the header file. If the newly selected waveform file has an associated header file, the ALC hold setting is updated with the value from the header file. The ALC hold setting will remain unchanged if the newly selected waveform does not have an associated header file.
Range	None M1 M2 M3 M4
Initial S/W Revision	A.05.00

None

Sets no marker to be used for the ALC hold function, essentially turning the ALC hold function off.

Key Path	Source, Modulation Setup, ARB, Marker Utilities, Marker Routing, ALC Hold
Example	:SOUR:RAD:ARB:MDES:PULS NONE
Initial S/W Revision	A.05.00

Marker 1

Sets marker 1 to be used for the ALC hold function.

Key Path	Source, Modulation Setup, ARB, Marker Utilities, Marker Routing, ALC Hold
Example	:SOUR:RAD:ARB:MDES:PULS M1
Initial S/W Revision	A.05.00

Marker 2

Sets marker 2 to be used for the ALC hold function.

Key Path	Source, Modulation Setup, ARB, Marker Utilities, Marker Routing, ALC Hold
Example	:SOUR:RAD:ARB:MDES:PULS M2
Initial S/W Revision	A.05.00

Marker 3

Sets marker 3 to be used for the ALC hold function.

Key Path	Source, Modulation Setup, ARB, Marker Utilities, Marker Routing, ALC Hold
Example	:SOUR:RAD:ARB:MDES:PULS M3
Initial S/W Revision	A.05.00

Marker 4

Sets marker 4 to be used for the ALC hold function.

Key Path	Source, Modulation Setup, ARB, Marker Utilities, Marker Routing, ALC Hold
Example	:SOUR:RAD:ARB:MDES:PULS M4
Initial S/W Revision	A.05.00

Header Utilities

Allows access to the header utilities sub-menu. Pressing this key also causes the central display area to change to display the File Header Information view.

Key Path	Source, Modulation Setup, ARB
Dependencies	This key is only available if there is currently a waveform selected for playback. If no waveform is selected, the key is grayed out.
Initial S/W Revision	A.05.00

Clear Header

Allows you to clear the header information from the file header associated with the currently selected waveform.

Key Path	Source, Modulation Setup, ARB, Header Utilities
Remote Command	:SOURce:RADio:ARB:HEADer:CLEar
Example	:SOUR:RAD:ARB:HEAD:CLE
Notes	Attempting to clear the header details via SCPI when no waveform was selected for playback will generate an error.
Initial S/W Revision	A.05.00

Save Setup To Header

Allows you to save new file header information details to the file.

Key Path	Source, Modulation Setup, ARB, Header Utilities
Remote Command	:SOURce:RADio:ARB:HEADer:SAVE
Example	:SOUR:RAD:ARB:HEAD:SAVE
Notes	Attempting to save the header details via SCPI when no waveform was selected for playback will generate an error.
Initial S/W Revision	A.05.00

AM

Allows access to the menu for configuring the Amplitude Modulation.

Key Path	Source, Modulation Setup
Initial S/W Revision	A.05.00

AM

Enables or disables the amplitude modulation.

Turning AM on when another modulation format is already on results in the previous modulation format being turned off and the generation of an error.

Key Path	Source, Modulation Setup, AM
Remote Command	:SOURce:AM:STATe :SOURce:AM:STATe?
Example	:SOUR:AM:STAT OFF

Preset	Off
Range	On Off
Initial S/W Revision	A.05.00

AM Depth

Allows you to set the amplitude modulation depth in percent.

Key Path	Source, Modulation Setup, AM
Remote Command	:SOURce:AM[:DEPTh] [:LINear] :SOURce:AM[:DEPTh] [:LINear]?
Example	:SOUR:AM 0.1
Preset	0.1 %
Min	0.1 %
Max	95.0 %
Initial S/W Revision	A.05.00

AM Rate

Allows you to set the internal amplitude modulation rate.

Key Path	Source, Modulation Setup, AM
Remote Command	:SOURce:AM:INTernal:FREQuency :SOURce:AM:INTernal:FREQuency?
Example	:SOUR:AM:INT:FREQ 40.0 Hz
Preset	400.0 Hz
Min	10 Hz
Max	40 kHz
Initial S/W Revision	A.05.00

FM

Allows access to the menu for configuring the frequency modulation.

Key Path	Source, Modulation Setup
Initial S/W Revision	A.05.00

FM

Enables or disables the frequency modulation.

Turning FM on when another modulation format is already on results in the previous modulation format being turned off and the generation of an error.

Key Path	Source, Modulation Setup, FM
Remote Command	:SOURce:FM:STATe :SOURce:FM:STATe?
Example	:SOUR:FM:STAT OFF
Preset	Off
Range	On Off
Initial S/W Revision	A.05.00

FM Deviation

Allows you to set the frequency modulation deviation.

Key Path	Source, Modulation Setup, FM
Remote Command	:SOURce:FM[:DEVIation] :SOURce:FM[:DEVIation]?
Example	:SOUR:FM 1.00 kHz
Preset	1.00 Hz
Min	1.00 Hz
Max	100.00 kHz
Initial S/W Revision	A.05.00

FM Rate

Allows you to set the internal frequency modulation rate.

Key Path	Source, Modulation Setup, FM
Remote Command	:SOURce:FM:INTernal:FREQuency :SOURce:FM:INTernal:FREQuency?
Example	:SOUR:FM:INT:FREQ 40.0 Hz
Preset	400.0 Hz
Min	10 Hz
Max	40 kHz
Initial S/W Revision	A.05.00

PM

Allows access to the menu for configuring the phase modulation.

Key Path	Source, Modulation Setup
Initial S/W Revision	A.05.00

PM

Enables or disables the phase modulation.

Turning PM on when another modulation format is already on results in the previous modulation format being turned off and the generation of an error.

Key Path	Source, Modulation Setup, PM
Remote Command	:SOURce:PM:STATe :SOURce:PM:STATe?
Example	:SOUR:PM:STAT OFF
Preset	Off
Range	On Off
Initial S/W Revision	A.05.00

PM Deviation

Allows you to set the phase modulation deviation.

Key Path	Source, Modulation Setup, PM
Remote Command	:SOURce:PM[:DEViation] :SOURce:PM[:DEViation]?
Example	:SOUR:PM 1.00 rad
Preset	0.1 rad
Min	0.1 rad
Max	20.0 rad
Initial S/W Revision	A.05.00

PM Rate

Allows you to set the internal phase modulation rate.

Key Path	Source, Modulation Setup, PM
Remote Command	:SOURce:PM:INTernal:FREQuency :SOURce:PM:INTernal:FREQuency?

Example	:SOUR:PM:INT:FREQ 40.0 Hz
Preset	400.0 Hz
Min	10 Hz
Max	40 kHz
Initial S/W Revision	A.05.00

List Sequencer

Allows you access to the sub-menus for configuring the list sequencer.

List sequences allows you to enter frequencies and amplitudes at unequal intervals in nonlinear ascending, descending or random order. Each step within the list can also include its own waveform file for playback, step duration, trigger event and trigger output.

The complexities involved in configuring the list sequencer do not lend itself to manual configuration; hence the manual configuration for this feature is limited. For easier configuration of the list sequencer, it is recommended that you use either SCPI or load a tab delimited file containing the setup parameters in a tabular form. The details of the SCPI for configuring the list sequencer can be found in Step Configuration (Remote Command Only).

Once the List Sequencer has been configured using the front panel, SCPI, or loading in a tab delimited file, the sequence must be initiated using the front panel Initiate Sequence key or the corresponding SCPI command.

Key Path	Source
Initial S/W Revision	A.05.00

Sequencer

Allows you to set the state of the list sequencer. When the list sequencer is on, the source is outputting the sequence defined by the sequencer. When the list sequencer is off, the source outputs a single waveform segment or sequence (independent mode) at a single frequency and amplitude.

Key Path	Source, List Sequencer
Remote Command	:SOURce:LIST[:STATe] ON OFF 1 0 :SOURce:LIST[:STATe]?
Example	:SOUR:LIST OFF
Notes	When the sequencer is set to ON, the list sequencer controls the output of the source.
Couplings	When in Sequence Analyzer mode and the list sequencer state is Off, Include Source is forced to No, and the Include Source key is grayed out. When in Sequence Analyzer mode and the list sequencer state is On, Include Source is available to set. And, an ARB memory related operation, like load or delete will be rejected.

Preset	Off
Range	On Off
Initial S/W Revision	A.05.00

Initiate Sequence

Pressing this key arms the sequence for single execution. Once the sequence is armed the source begins the sequence as soon as the trigger is received. If the trigger is set to Free Run, the sequence starts immediately.

Key Path	Source, List Sequencer
Remote Command	:SOURce:LIST:TRIGger[:IMMediate]
Example	:SOUR:LIST:TRIG
Notes	<p>When in Sequence Analyzer mode and Include Source is Yes, the Initiate list sequencer operation is rejected, and the key is grayed out, since source list sequence request is sent to physics via Parallel batch by sequence analyzer.</p> <p>If the file needed by the sequencer is not already in ARB memory, the sequence cannot be initiated and an error will be generated.</p> <p>There is a blocking SCPI query which can be used to query if source list sequence being initiated successfully or not. (see Query List Sequence Initiation Armed Status (Remote Command Only) Query Source List Sequence Armed Status)</p>
Dependencies	Under the Sequence Analyzer Mode, if Meas Setup->Include Source is set to YES, Source->List Sequencer->Initiate Sequence is disabled.
Initial S/W Revision	A.05.00

List Sequencer Setup

Allows you access to the list sequencer setup menus.

Key Path	Source, List Sequencer
----------	------------------------

Number of Steps

Allows you to specify the number of steps within the list sequence.

Key Path	Source, List Sequencer, List Sequencer Setup
Remote Command	:SOURce:LIST:NUMBer:STEPs <integer> :SOURce:LIST:NUMBer:STEPs?
Example	:SOUR:LIST:NUMB:STEP 1
Notes	Increasing the number of steps creates additional steps at the end of the list, with all the settings

	within the steps set to their default values. Decreasing the number of steps removes steps from the end of the list. The settings within the removed steps are not reset. This means that increasing the number of steps again would allow you to retrieve these steps.
Dependencies	The Step Count parameter is increased or decreased when you insert or delete a point from within the GUI interface to the sequencer.
Preset	1
Min	1
Max	1000
Initial S/W Revision	A.05.00

Current Step

Allows you to select the step number you wish to view or edit.

Key Path	Source, List Sequencer, List Sequencer Setup
Notes	No remote command, front panel only.
Preset	1
Min	1
Max	Step Count
Initial S/W Revision	A.05.00

Insert Step Before

Allows you to insert a new step, containing default values, before the currently selected step. Inserting a step will automatically increase the Step Count parameter by 1. If sequence already reaches upper limit of 1000 steps, then insert more step will be rejected and popup error -221, "Setting Conflict; Cannot insert more steps, maximum number of steps reached"

Key Path	Source, List Sequencer, List Sequencer Setup
Notes	No remote command, front panel only. If the list already contains the maximum limit of 1000 steps, no operation will be made after pressing this key.
Initial S/W Revision	A.05.00

Delete Step

Allows you to delete the current step. Deleting a step will automatically decrease the Step Count parameter by 1. If sequence only has one step left, delete step will be rejected and popup error -221, "Setting conflict; Cannot delete current step, minimum number of steps reached"

Key Path	Source, List Sequencer, List Sequencer Setup
Notes	No remote command, Front Panel key only. If the list already contains the minimum limit of 1 step, no operation will be made after pressing this key
Initial S/W Revision	A.05.00

Clear List

Allows you to clear the list. Clearing the list sets the number of steps to the default value of 1 and sets the parameters for the only step to their default values.

Key Path	Source, List Sequencer, List Sequencer Setup
Initial S/W Revision	A.05.00

Step Trigger

Allows access to the sub-menu for selecting the trigger input for the current step.

Key Path	Source, List Sequencer, List Sequencer Setup
Remote Command	:SOURCE:LIST:STEP[1] 2 3...1000:SETup:INPut:TRIGger IMMEDIATE INTERNAL EXTERNAL2 KEY BUS EXTERNAL4 :SOURCE:LIST:STEP[1] 2 3...1000:SETup:INPut:TRIGger?
Example	:SOUR:LIST:STEP2:SET:INP:TRIG BUS :SOUR:LIST:STEP2:SET:INP:TRIG?
Notes	SCPI is supported after A.09.40
Preset	Free Run
Range	Free Run Internal Manual (Trigger Key) Bus External 2 EXTERNAL4
Initial S/W Revision	A.05.00

Free Run

Sets the trigger input for the current step to Free Run.

Key Path	Source, List Sequencer, List Sequencer Setup, Step Trigger
Example	:SOUR:LIST:STEP2:SET:INP:TRIG IMM
Notes	SCPI is supported after A.09.40
Initial S/W Revision	A.05.00

Internal

Sets the trigger input for the current step to Internal.

Key Path	Source, List Sequencer, List Sequencer Setup, Step Trigger
Example	:SOUR:LIST:STEP2:SET:INP:TRIG INT
Notes	SCPI is supported after A.09.40
Initial S/W Revision	A.05.00

Manual (Trigger Key)

Sets the trigger input for the current step to Manual (Trigger Key). Any step in the sequence set to Manual will cause the sequence execution to stop until the manual trigger key is pressed. Sending the Bus Trigger SCPI command will have no effect. At any point in the sequence where the list sequencer is paused waiting for a software trigger, a pop up dialog is displayed until the trigger event occurs.

Key Path	Source, List Sequencer, List Sequencer Setup, Step Trigger
Example	:SOUR:LIST:STEP2:SET:INP:TRIG KEY
Notes	SCPI is supported after A.09.40
Initial S/W Revision	A.05.00

Bus

Sets the trigger input for the current step to Bus. Any step in the sequence set to Bus will cause the sequence execution to stop until the Bus Trigger SCPI command is sent. Pressing the manual trigger key has no effect. At any point in the sequence where the list sequencer is paused waiting for a software trigger, a pop up dialog is displayed until the trigger event occurs.

Key Path	Source, List Sequencer, List Sequencer Setup, Step Trigger
Example	:SOUR:LIST:STEP2:SET:INP:TRIG BUS
Notes	SCPI is supported after A.09.40
Initial S/W Revision	A.05.00

External 2

Sets the trigger input for the current step to External 2.

Key Path	Source, List Sequencer, List Sequencer Setup, Step Trigger
Example	:SOUR:LIST:STEP2:SET:INP:TRIG EXT2
Notes	SCPI is supported after A.09.40
Notes	Note: When on E6640A, trigger 2 is a bi-directional trigger port. So when trigger 2 has been configured as OUTPUT type, choosing External 2 as the input trigger for the current step will generate error.
Initial S/W Revision	A.05.00

Transition Time

Allows you to specify the transition time for the current step.

The transition time is the amount of time allowed for the source to settle at the current frequency or amplitude value.

Transition Time should not be taken as additional time before or inside the Step Duration. You can set a value for the settling time to allow the source output frequency or amplitude to become stable. Make sure that during this period of time, you do not use the source output signal.

The following table lists recommended values for appropriate settling times to allow for changes within the source.

Value Changed	Recommended Transition Time
Frequency	500 μ s
Amplitude	100 μ s to within 0.1 dB 20 μ s to within 1.0 dB

If the Transition Time value is shorter than the time necessary for the hardware to settle and a List Sequence is initiated, a **warning** is generated.

If the Transition Time value is longer than the Step Duration, an error is generated when initiating a source list sequence. For source list sequence, transition time is included in the step duration length. If the Transition Time value is longer than the Step Duration Time, the real step duration length is extended to equal the transition time and cause a timing shift.

Key Path	Source, List Sequencer, List Sequencer Setup
Remote Command	:SOURce:LIST:STEP[1] 2 3...1000:SETup:TRANSition:TIME <time> :SOURce:LIST:STEP[1] 2 3...1000:SETup:TRANSition:TIME?
Example	:SOUR:LIST:STEP2:SET:TRAN:TIME 1ms :SOUR:LIST:STEP2:SET:TRAN:TIME?
Notes	SCPI is supported after A.09.40
Preset	1.0 ms
Min	0.0 ms
Max	4.0 ks
Initial S/W Revision	A.05.00

Radio Setup

Allows you access to the sub-menus for setting up the radio standard, band, and radio band link direction for the current step.

Key Path	Source, List Sequencer, List Sequencer Setup
Notes	No remote command, front panel only.

Initial S/W Revision	A.05.00
----------------------	---------

Radio Standard

Allows access to the sub-menus for selecting the radio standard and the associated radio band for use in the current step.

Key Path	Source, List Sequencer, List Sequencer Setup, Radio Setup
Remote Command	:SOURCE:LIST:STEP[1] 2 3...1000:SETup:RADio:BAND NONE PGSM EGSM RGSM DCS1800 PCS1900 TGSM810 GSM450 GSM480 GSM700 GSM850 BANDI BANDII BANDIII BANDIV BANDV BANDVI BANDVII BANDVIII BANDIX BANDX BANDXI BANDXII BANDXIII BANDXIV BANDXIX USCELL USPCS JAPAN KOREAN NMT IMT2K UPPER SECOND PAMR400 PAMR800 IMTEXT PCS1DOT9G AWS US2DOT5G PUBLIC LOWER NONE BAND1 BAND2 BAND3 BAND4 BAND5 BAND6 BAND7 BAND8 BAND10 BAND11 BAND12 BAND13 BAND14 BAND17 BAND18 BAND19 BAND20 BAND21 BAND24 BAND25 BAND26 BAND27 BAND28 BAND29 BAND30 BAND31 BAND33 BAND34 BAND35 BAND36 BAND37 BAND38 BAND39 BAND40 BAND41 BAND42 BAND43 BAND44 BANDA BANDB BANDC BANDD BANDE BANDF :SOURCE:LIST:STEP[1] 2 3...1000:SETup: RADio:BAND?
Example	:SOUR:LIST:STEP2:SET:RAD:BAND PGSM :SOUR:LIST:STEP2:SET:RAD:BAND?
Notes	SCPI is supported after A.09.40
Initial S/W Revision	A.05.00

None

Selects no radio standard for use on the current step.

Key Path	Source, List Sequencer, List Sequencer Setup, Radio Setup, Radio Standard
Example	:SOUR:LIST:STEP2:SET:RAD:BAND NONE
Notes	SCPI is supported after A.09.40
Initial S/W Revision	A.05.00

GSM/EDGE

Pressing this key once selects GSM/EDGE as the radio standard and the current GSM/EDGE band as the active channel band. Pressing this key again allows access to the sub-menus for selecting a different GSM/EDGE band.

Key Path	Source, List Sequencer, List Sequencer Setup, Radio Setup, Radio Standard
Initial S/W Revision	A.05.00

P-GSM

Selects P-GSM as the band for the current step.

Key Path	Source, List Sequencer, List Sequencer Setup, Radio Setup, Radio Standard, GSM/EDGE
Initial S/W Revision	A.05.00

E-GSM

Selects E-GSM as the band for the current step.

Key Path	Source, List Sequencer, List Sequencer Setup, Radio Setup, Radio Standard, GSM/EDGE
Initial S/W Revision	A.05.00

R-GSM

Selects R-GSM as the band for the current step.

Key Path	Source, List Sequencer, List Sequencer Setup, Radio Setup, Radio Standard, GSM/EDGE
Initial S/W Revision	A.05.00

DCS 1800

Selects DCS 1800 as the band for the current step.

Key Path	Source, List Sequencer, List Sequencer Setup, Radio Setup, Radio Standard, GSM/EDGE
Initial S/W Revision	A.05.00

PCS 1900

Selects PCS 1900 as the band for the current step.

Key Path	Source, List Sequencer, List Sequencer Setup, Radio Setup, Radio Standard, GSM/EDGE
Initial S/W Revision	A.05.00

GSM 450

Selects GSM 450 as the band for the current step.

Key Path	Source, List Sequencer, List Sequencer Setup, Radio Setup, Radio Standard, GSM/EDGE
Initial S/W Revision	A.05.00

GSM 480

Selects GSM 480 as the band for the current step.

Key Path	Source, List Sequencer, List Sequencer Setup, Radio Setup, Radio Standard, GSM/EDGE
Initial S/W Revision	A.05.00

GSM 850

Selects GSM 850 as the band for the current step.

Key Path	Source, List Sequencer, List Sequencer Setup, Radio Setup, Radio Standard, GSM/EDGE
Initial S/W Revision	A.05.00

GSM 700

Selects GSM 700 as the band for the current step.

Key Path	Source, List Sequencer, List Sequencer Setup, Radio Setup, Radio Standard, GSM/EDGE
Initial S/W Revision	A.05.00

T-GSM 810

Selects T-GSM 810 as the band for the current step.

Key Path	Source, List Sequencer, List Sequencer Setup, Radio Setup, Radio Standard, GSM/EDGE
Initial S/W Revision	A.05.00

WCDMA

Pressing this key once selects WCDMA as the radio standard and the current WCDMA band as the active channel band. Pressing this key again allows access to the sub-menus for selecting a different WCDMA band.

Key Path	Source, List Sequencer, List Sequencer Setup, Radio Setup, Radio Standard
Initial S/W Revision	A.05.00

Band I

Selects Band I as the band for the current step.

Key Path	Source, List Sequencer, List Sequencer Setup, Radio Setup, Radio Standard, WCDMA
Initial S/W Revision	A.05.00

Band II

Selects Band II as the band for the current step.

Key Path	Source, List Sequencer, List Sequencer Setup, Radio Setup, Radio Standard, WCDMA
Initial S/W Revision	A.05.00

Band III

Selects Band III as the band for the current step.

Key Path	Source, List Sequencer, List Sequencer Setup, Radio Setup, Radio Standard, WCDMA
Initial S/W Revision	A.05.00

Band IV

Selects Band IV as the band for the current step.

Key Path	Source, List Sequencer, List Sequencer Setup, Radio Setup, Radio Standard, WCDMA
Initial S/W Revision	A.05.00

Band V

Selects Band V as the band for the current step.

Key Path	Source, List Sequencer, List Sequencer Setup, Radio Setup, Radio Standard, WCDMA
Initial S/W Revision	A.05.00

Band VI

Selects Band VI as the band for the current step.

Key Path	Source, List Sequencer, List Sequencer Setup, Radio Setup, Radio Standard, WCDMA
Initial S/W Revision	A.05.00

Band VII

Selects Band VII as the band for the current step.

Key Path	Source, List Sequencer, List Sequencer Setup, Radio Setup, Radio Standard, WCDMA
Initial S/W Revision	A.05.00

Band VIII

Selects Band VIII as the band for the current step.

Key Path	Source, List Sequencer, List Sequencer Setup, Radio Setup, Radio Standard, WCDMA
Initial S/W Revision	A.05.00

Band IX

Selects Band IX as the band for the current step.

Key Path	Source, List Sequencer, List Sequencer Setup, Radio Setup, Radio Standard, WCDMA
Initial S/W Revision	A.05.00

Band X

Selects Band X as the band for the current step.

Key Path	Source, List Sequencer, List Sequencer Setup, Radio Setup, Radio Standard, WCDMA
Initial S/W Revision	A.05.00

Band XI

Selects Band XI as the band for the current step.

Key Path	Source, List Sequencer, List Sequencer Setup, Radio Setup, Radio Standard, WCDMA
Initial S/W Revision	A.05.00

Band XII

Selects Band XII as the band for the current step.

Key Path	Source, List Sequencer, List Sequencer Setup, Radio Setup, Radio Standard, WCDMA
Initial S/W Revision	A.05.00

Band XIII

Selects Band XIII as the band for the current step.

Key Path	Source, List Sequencer, List Sequencer Setup, Radio Setup, Radio Standard, WCDMA
Initial S/W Revision	A.05.00

Band XIV

Selects Band XIV as the band for the current step.

Key Path	Source, List Sequencer, List Sequencer Setup, Radio Setup, Radio Standard, WCDMA
Initial S/W Revision	A.05.00

LTE

Pressing this key once selects LTE FDD as the radio standard and the current LTE FDD band as the active channel band. Pressing this key again allows access to the sub-menus for selecting a different LTE FDD band.

Key Path	Source, List Sequencer, List Sequencer Setup, Radio Setup, Radio Standard
Initial S/W Revision	A.09.50

BAND 1

Selects BAND 1 as the band for the current step.

Key Path	Source, List Sequencer, List Sequencer Setup, Radio Setup, Radio Standard, LTE
Initial S/W Revision	A.09.50

BAND 2

Selects BAND 2 as the band for the current step.

Key Path	Source, List Sequencer, List Sequencer Setup, Radio Setup, Radio Standard, LTE
Initial S/W Revision	A.09.50

BAND 3

Selects BAND 3 as the band for the current step.

Key Path	Source, List Sequencer, List Sequencer Setup, Radio Setup, Radio Standard, LTE
Initial S/W Revision	A.09.50

BAND 4

Selects BAND 4 as the band for the current step.

Key Path	Source, List Sequencer, List Sequencer Setup, Radio Setup, Radio Standard, LTE
Initial S/W Revision	A.09.50

BAND 5

Selects BAND 5 as the band for the current step.

Key Path	Source, List Sequencer, List Sequencer Setup, Radio Setup, Radio Standard, LTE
Initial S/W Revision	A.09.50

BAND 6

Selects BAND 6 as the band for the current step.

Key Path	Source, List Sequencer, List Sequencer Setup, Radio Setup, Radio Standard, LTE
Initial S/W Revision	A.09.50

BAND 7

Selects BAND 7 as the band for the current step.

Key Path	Source, List Sequencer, List Sequencer Setup, Radio Setup, Radio Standard, LTE
Initial S/W Revision	A.09.50

BAND 8

Selects BAND 8 as the band for the current step.

Key Path	Source, List Sequencer, List Sequencer Setup, Radio Setup, Radio Standard, LTE
Initial S/W Revision	A.09.50

BAND 9

Selects BAND 9 as the band for the current step.

Key Path	Source, List Sequencer, List Sequencer Setup, Radio Setup, Radio Standard, LTE
Initial S/W Revision	A.09.50

BAND 10

Selects BAND 10 as the band for the current step.

Key Path	Source, List Sequencer, List Sequencer Setup, Radio Setup, Radio Standard, LTE
Initial S/W Revision	A.09.50

BAND 11

Selects BAND 11 as the band for the current step.

Key Path	Source, List Sequencer, List Sequencer Setup, Radio Setup, Radio Standard, LTE
Initial S/W Revision	A.09.50

BAND 12

Selects BAND 12 as the band for the current step.

Key Path	Source, List Sequencer, List Sequencer Setup, Radio Setup, Radio Standard, LTE
Initial S/W Revision	A.09.50

BAND 13

Selects BAND 13 as the band for the current step.

Key Path	Source, List Sequencer, List Sequencer Setup, Radio Setup, Radio Standard, LTE
Initial S/W Revision	A.09.50

BAND 14

Selects BAND 14 as the band for the current step.

Key Path	Source, List Sequencer, List Sequencer Setup, Radio Setup, Radio Standard, LTE
Initial S/W Revision	A.09.50

BAND 17

Selects BAND 17 as the band for the current step.

Key Path	Source, List Sequencer, List Sequencer Setup, Radio Setup, Radio Standard, LTE
Initial S/W Revision	A.09.50

BAND 18

Selects BAND 18 as the band for the current step.

Key Path	Source, List Sequencer, List Sequencer Setup, Radio Setup, Radio Standard, LTE
Initial S/W Revision	A.09.50

BAND 19

Selects BAND 19 as the band for the current step.

Key Path	Source, List Sequencer, List Sequencer Setup, Radio Setup, Radio Standard, LTE
Initial S/W Revision	A.09.50

BAND 20

Selects BAND 20 as the band for the current step.

Key Path	Source, List Sequencer, List Sequencer Setup, Radio Setup, Radio Standard, LTE
Initial S/W Revision	A.09.50

BAND 21

Selects BAND 21 as the band for the current step.

Key Path	Source, List Sequencer, List Sequencer Setup, Radio Setup, Radio Standard, LTE
Initial S/W Revision	A.09.50

BAND 24

Selects BAND 24 as the band for the current step.

Key Path	Source, List Sequencer, List Sequencer Setup, Radio Setup, Radio Standard, LTE
Initial S/W Revision	A.09.50

BAND 25

Selects BAND 25 as the band for the current step.

Key Path	Source, List Sequencer, List Sequencer Setup, Radio Setup, Radio Standard, LTE
Initial S/W Revision	A.09.50

BAND 26

Selects BAND 26 as the band for the current step.

Key Path	Source, List Sequencer, List Sequencer Setup, Radio Setup, Radio Standard, LTE
Initial S/W Revision	A.12.53

BAND 27

Selects BAND 27 as the band for the current step.

Key Path	Source, List Sequencer, List Sequencer Setup, Radio Setup, Radio Standard, LTE
Initial S/W Revision	A.14.00

BAND 28

Selects BAND 28 as the band for the current step.

Key Path	Source, List Sequencer, List Sequencer Setup, Radio Setup, Radio Standard, LTE
Initial S/W Revision	A.14.00

BAND 31

Selects BAND 31 as the band for the current step.

Key Path	Source, List Sequencer, List Sequencer Setup, Radio Setup, Radio Standard, LTE
Initial S/W Revision	A.14.00

LTE TDD

Sets LTE TDD as the radio standard for use and accesses the LTE TDD specific channel band sub-menus..

Key Path	Source, Frequency, Radio Setup, Radio Standard
Initial S/W Revision	A.11.50

BAND 33

Selects BAND 33 as the band for the current step.

Key Path	Source, Frequency, Radio Setup, Radio Standard, LTE TDD
Example	:SOUR:FREQ:CHAN:BAND BAND33
Initial S/W Revision	A.11.50

BAND 34

Selects BAND 34 as the band for the current step.

Key Path	Source, Frequency, Radio Setup, Radio Standard, LTE TDD
Example	:SOUR:FREQ:CHAN:BAND BAND34
Initial S/W Revision	A.11.50

BAND 35

Selects BAND 35 as the band for the current step.

Key Path	Source, Frequency, Radio Setup, Radio Standard, LTE TDD
Example	:SOUR:FREQ:CHAN:BAND BAND35
Initial S/W Revision	A.11.50

BAND 36

Selects BAND 36 as the band for the current step.

Key Path	Source, Frequency, Radio Setup, Radio Standard, LTE TDD
Example	:SOUR:FREQ:CHAN:BAND BAND36
Initial S/W Revision	A.11.50

BAND 37

Selects BAND 37 as the band for the current step.

Key Path	Source, Frequency, Radio Setup, Radio Standard, LTE TDD
Example	:SOUR:FREQ:CHAN:BAND BAND37
Initial S/W Revision	A.11.50

BAND 38

Selects BAND 38 as the band for the current step.

Key Path	Source, Frequency, Radio Setup, Radio Standard, LTE TDD
Example	:SOUR:FREQ:CHAN:BAND BAND38
Initial S/W Revision	A.11.50

BAND 39

Selects BAND 39 as the band for the current step.

Key Path	Source, Frequency, Radio Setup, Radio Standard, LTE TDD
Example	:SOUR:FREQ:CHAN:BAND BAND39
Initial S/W Revision	A.11.50

BAND 40

Selects BAND 40 as the band for the current step.

Key Path	Source, Frequency, Radio Setup, Radio Standard, LTE TDD
Example	:SOUR:FREQ:CHAN:BAND BAND40
Initial S/W Revision	A.11.50

BAND 41

Selects BAND 41 as the band for the current step.

Key Path	Source, Frequency, Radio Setup, Radio Standard, LTE TDD
Example	:SOUR:FREQ:CHAN:BAND BAND41
Initial S/W Revision	A.11.50

BAND 42

Selects BAND 42 as the band for the current step.

Key Path	Source, Frequency, Radio Setup, Radio Standard, LTE TDD
Example	:SOUR:FREQ:CHAN:BAND BAND42
Initial S/W Revision	A.11.50

BAND 43

Selects BAND 43 as the band for the current step.

Key Path	Source, Frequency, Radio Setup, Radio Standard, LTE TDD
Example	:SOUR:FREQ:CHAN:BAND BAND43
Initial S/W Revision	A.11.50

BAND 44

Selects BAND 44 as the band for the current step.

Key Path	Source, List Sequencer, List Sequencer Setup, Radio Setup, Radio Standard, LTE TDD
Initial S/W Revision	A.14.00

TDSCDMA

Sets TDSCDMA as the radio standard for use and accesses the TDSCDMA specific channel band sub-menus..

Key Path	Source, Frequency, Radio Setup, Radio Standard
Initial S/W Revision	A.11.50

BAND A

Selects BAND A as the band for the current step.

Key Path	Source, Frequency, Radio Setup, Radio Standard, TDSCDMA
Example	:SOUR:FREQ:CHAN:BAND BANDA
Initial S/W Revision	A.11.50

BAND B

Selects BAND B as the band for the current step.

Key Path	Source, Frequency, Radio Setup, Radio Standard, TDSCDMA
Example	:SOUR:FREQ:CHAN:BAND BANDB
Initial S/W Revision	A.11.50

BAND C

Selects BAND C as the band for the current step.

Key Path	Source, Frequency, Radio Setup, Radio Standard, TDSCDMA
Example	:SOUR:FREQ:CHAN:BAND BANDC
Initial S/W Revision	A.11.50

BAND D

Selects BAND D as the band for the current step.

Key Path	Source, Frequency, Radio Setup, Radio Standard, TDSCDMA
Example	:SOUR:FREQ:CHAN:BAND BANDD
Initial S/W Revision	A.11.50

BAND E

Selects BAND E as the band for the current step.

Key Path	Source, Frequency, Radio Setup, Radio Standard, TDSCDMA
Example	:SOUR:FREQ:CHAN:BAND BANDE
Initial S/W Revision	A.11.50

BAND F

Selects BAND F as the band for the current step.

Key Path	Source, Frequency, Radio Setup, Radio Standard, TDSCDMA
Example	:SOUR:FREQ:CHAN:BAND BANDF
Initial S/W Revision	A.11.50

Radio Band Link

Allows you to specify the radio band link direction for the steps within the list sequence. The link is used in conjunction with the channel band and channel number to determine the output frequency.

When set to “Uplink”, the source will calculate the uplink frequency according to an uplink formula together with selected channel band and channel number. When set to “Downlink”, the source will calculate the downlink frequency according to a downlink formula together with selected channel band and channel number.

Key Path	Source, List Sequencer, List Sequencer Setup, Radio Setup
Remote Command	:SOURce:LIST:STEP[1] 2 3...1000:SETup:RADio:BAND:LINK DOWN UP :SOURce:LIST:STEP[1] 2 3...1000:SETup:RADio:BAND:LINK?
Example	:SOUR:LIST:STEP2:SET:RAD:BAND:LINK UP :SOUR:LIST:STEP2:SET:RAD:BAND:LINK?
Notes	SCPI is supported after A.09.40
Preset	DOWN
Range	DOWN UP
Initial S/W Revision	A.05.00

Channel

Allows you to specify the frequency of the current step via a channel number.

Key Path	Source, List Sequencer, List Sequencer Setup
Remote Command	:SOURce:LIST:STEP[1] 2 3...1000:SETup:CNFRrequency <double> :SOURce:LIST:STEP[1] 2 3...1000:SETup:CNFRrequency?
Example	:SOUR:LIST:STEP2:SET:CNFR 124 :SOUR:LIST:STEP2:SET:CNFR?
Notes	SCPI is supported after A.09.40. This SCPI is used to setup channel number or frequency setting, according to current Radio Band setting. If Radio Band is "NONE", then it's frequency. If Radio Band is not "NONE", then it's channel number.
Couplings	The channel number is coupled to the step frequency value. When the step frequency value is changed, the channel number will increase or decrease to match the new step frequency. If the step frequency is not at an exact match for a channel number, the nearest channel number is displayed, along with a greater than, or less than sign to indicate the frequency is above or below the channel number.
Preset	1
Min	0 (Please refer to for valid ranges.)
Max	10838 (Please refer to for valid ranges.)
Initial S/W Revision	A.05.00

Frequency

Allows you to specify a frequency value for the current step.

Key Path	Source, List Sequencer, List Sequencer Setup
Remote Command	:SOURce:LIST:STEP[1] 2 3...1000:SETup:CNFRrequency <double> :SOURce:LIST:STEP[1] 2 3...1000:SETup:CNFRrequency?
Example	:SOUR:LIST:STEP2:SET:CNFR 1GHz :SOUR:LIST:STEP2:SET:CNFR?
Notes	SCPI is supported after A.09.40. This SCPI is used to setup channel number or frequency setting, according to current Radio Band setting. If Radio Band is "NONE", then it's frequency. If Radio Band is not "NONE", then it's channel number.
Couplings	The frequency value is coupled to the channel band and number for the step, such that updates to the radio band and channel number will update the frequency value to the corresponding absolute frequency. The reverse is also true, changing the frequency value causes the value of the channel number to be updated.
Preset	1.00 GHz
Min	10.00 MHz
Max	Hardware Dependant:

	Option 503 = 3.6 GHz Option 504 = 3.9 GHz Option 506 = 6.00 GHz
Initial S/W Revision	A.05.00

Power

Allows you to specify a power value for the current step.

Key Path	Source, List Sequencer, List Sequencer Setup
Remote Command	:SOURce:LIST:STEP[1] 2 3...1000:SETup:AMPLitude <double> :SOURce:LIST:STEP[1] 2 3...1000:SETup:AMPLitude?
Example	:SOUR:LIST:STEP2:SET:AMPL -50dBm :SOUR:LIST:STEP2:SET:AMPL?
Notes	SCPI is supported after A.09.40
Notes	Amplitude corrections can be specified for use with the source. In the event of amplitude corrections being applied, the valid ranges for the RF power do not change dependant on the current amplitude correction setting. Instead, if the combination of RF power + amplitude correction is higher or lower than the source output range, the Source Unleveled bit is set and the "Source Unleveled" indicator will appear on status panel to indicate that the source cannot maintain the output power that has been requested. The multiport adapter RFIO TX ports and GPS ports cannot ensure power accuracy when power setting is lower than -130dBm, this power setting value is defined by the sum of RF Power setting and related amplitude correction value. But user settable value could be lower than this limit. When application detected there exists power setting lower than -130dBm on MPA RFIO TX ports, then popup warning message . When application detected there exists power setting lower than -130dBm on MPA GPS ports, then popup warning message . These are only warning messages, and check is performed when RF is ON.
Notes	The Min and Max value here defined UI settable amplitude range. This range is larger than actual amplitude range with level accuracy defined in spec.
Dependencies	The RF power is dependent on the RF output port and frequency, such that the current frequency and selected output port determine the valid range of power values.
Preset	-100 dBm
Min	The range of values depends on the current frequency and selected RF output port. Please refer to "RF Power" on page 2098 and the table RF Power Range for the valid ranges.
Max	The range of values depends on the current frequency and selected RF output port. Please refer to "RF Power" on page 2098 and the table RF Power Range for the valid ranges.
Initial S/W Revision	A.05.00

Waveform

Allows you access to the sub-menus for selecting the waveform to be played back during the current step. Pressing this key also changes the central display area to show the Waveform File Selection view.

Key Path	Source, List Sequencer, List Sequencer Setup
Remote Command	:SOURce:LIST:STEP[1] 2 3...1000:SETup:WAVeform <string> :SOURce:LIST:STEP[1] 2 3...1000:SETup:WAVeform?
Example	:SOUR:LIST:STEP2:SET:WAV "CW" :SOUR:LIST:STEP2:SET:WAV?
Notes	SCPI is supported after A.09.40
Remote Command Notes	String type, takes "Off" "CW" "Cont" "waveform name"
Preset	CW
Range	Waveform Continue Previous CW Off
Initial S/W Revision	A.05.00

CW

Sets the current step to output a CW tone.

Key Path	Source, List Sequencer, List Sequencer Setup, Waveform
Example	:SOUR:LIST:STEP2:SET:WAV "CW"
Notes	SCPI is supported after A.09.40
Initial S/W Revision	A.05.00

Selected Waveform

Inserts the currently selected waveform in the waveform selection view as the waveform for playback during the current step.

Key Path	Source, List Sequencer, List Sequencer Setup, Waveform
Example	:SOUR:LIST:STEP2:SET:WAV "waveform name"
Notes	SCPI is supported after A.09.40 If the selected waveform contains header (which contains ARB play parameters), source list sequence will automatically apply header settings of the selected waveform in that step.
Initial S/W Revision	A.05.00

Continue Previous

Sets the current step to continue with playback of the waveform from the previous step. When continuing the previous waveform, the ARB playback will not pause while the source retunes to the new frequency or amplitude that may be defined for the new step.

Key Path	Source, List Sequencer, List Sequencer Setup, Waveform
----------	--

Example	:SOUR:LIST:STEP2:SET:WAV "Cont"
Notes	SCPI is supported after A.09.40
Initial S/W Revision	A.05.00

Off

Disable RF output of the current step.

Key Path	Source, List Sequencer, List Sequencer Setup, Waveform
Example	:SOUR:LIST:STEP2:SET:WAV "Off"
Notes	SCPI is supported after A.09.40
Initial S/W Revision	A.05.00

Segments on Hard Disk

Allows you access to the sub-menus for loading waveform segments from the hard disk into ARB memory. The default directory is: D: varb.

Pressing this key changes the current view to the Waveform Management View.

Key Path	Source, Modulation Setup, ARB, Select Waveform
Initial S/W Revision	A.05.00

Load Segment To ARB Memory

Allows you to load the selected file into ARB memory. On the front panel you select the file for loading to the ARB memory by highlighting the desired file in the list. Using the SCPI command, you specify the file name on the HDD.

"NVWFM" (none-volatile storage) MSUS (Mass Storage Unit Specifier) is supported in the memory subsystem because the ARB memory cannot be accessed directly. Therefore, files must be downloaded to the instrument hard disk and then loaded into the ARB memory. "NVWFM" MSUS will be mapped to the default directory D: VARB. The SCPI command supports using either "NVWFM" MSUS or specifying a full path. For more information, see Memory Subsystem (Remote Command Only).

If a file of the same name already exists within ARB memory, it is overwritten. If you wish to load two segments of the same name, you must rename one of the segments before loading it into ARB memory. To rename a segment, you can either use Windows File Explorer, or the :MMEMORY:COPY command.

NOTE: When a waveform file is loaded to ARB memory, burst timing adjustments are made automatically, based on whether or not a Multiport Adapter is connected to the test set and powered on. If the connection/power status of the Multiport Adapter is changed after a waveform file has been loaded, it needs to be loaded again.

Key Path	Source, Modulation Setup, ARB, Select Waveform, Segments on Hard Disk
Remote Command	:SOURce:RADio:ARB:LOAD <string>
Example	:SOUR:RAD:ARB:LOAD "D: VARB\testwaveform.bin" or :SOUR:RAD:ARB:LOAD "NVWFM:testwaveform.bin"
Notes	<p>Because loading the file involves a delay of unpredictable length, this command should be followed by the query *OPC?, which holds off subsequent commands until the loading operating is complete.</p> <p><string> – specifies the path name of the file to load from the HDD into ARB memory. It could be a <full path + filename>, or <"NVWFM" MSUS + colon + filename>.</p> <p>When in Sequence Analyzer mode, and Include Source is Yes, an attempt to load a file to ARB memory will be rejected with an error.</p> <p>When Include Source is No and if there is insufficient free ARB memory to load the selected waveform, an error is generated. .</p> <p>If you specify a file over SCPI, but the file is not at the specified location, an error is generated.</p> <p>If you try to load a waveform file but the file contains less than 500 IQ samples, an error is generated.</p> <p>If you try to load a Signal Studio waveform "*.wfm" which contains invalid waveform header, an error is generated.</p> <p>If the ARB is ON when you load a file to ARB memory or delete a file from ARB memory, the playing waveform segment may not keep phase continuity during the ARB memory operation. The waveform will be replayed after the ARB operation is finished.</p> <p>ARB can be loaded into ARB memory even required licenses do not present on the instrument. In this case, a GUI only warning message -800, "Operation complete; Loaded <filename> successfully, but no license <required licenses> installed". User can install required licenses according to <required licenses> string to license it, or multi-pack license it.</p>
Initial S/W Revision	A.05.00

Load All To ARB Memory

Allows you to load all the segment files within the currently selected directory into ARB memory. If a file of the same name already exists within ARB memory, it is overwritten. If you wish to load two segments of the same name, you must rename one of the segments before loading it into ARB memory. To rename a segment, you can either use Windows File Explorer, or the :MEMory:COPY command.

NOTE: When a waveform file is loaded to ARB memory, burst timing adjustments are made automatically, based on whether or not a Multiport Adapter is connected to the test set and powered on. If the connection/power status of the Multiport Adapter is changed after a waveform file has been loaded, it needs to be loaded again.

Key Path	Source, Modulation Setup, ARB, Select Waveform, Segments on Hard Disk
Remote Command	:SOURce:RADio:ARB:LOAD:ALL <string>
Example	:SOUR:RAD:ARB:LOAD:ALL "D: varb"
Notes	<p><string> - specifies the directory on the HDD to load the files into ARB memory from.</p> <p>When in Sequence Analyzer mode, and Include Source is Yes, an attempt to load all files from a directory to ARB memory is rejected with an error.</p>

	<p>When Include Source is No and there is insufficient free ARB memory to load all the waveforms, when the ARB memory is full, the copy ceases, and an error is generated.</p> <p>If you specify a directory over SCPI, but the directory does not exist, an error is generated.</p> <p>If the ARB is ON, a user then loads or deletes file to ARB memory, the playing waveform segment may not keep phase continuity during the ARB memory operation. The waveform will be replayed after the ARB operation is finished.</p>
Initial S/W Revision	A.05.00

Change Directory...

Allows you to change the currently selected directory on the hard disk. Pressing this key opens a standard windows change directory dialog allowing you to select the new directory of interest.

The current directory is used for manually loading waveform segments into ARB memory for playback, and as a search location for waveform segments that are required to be loaded into ARB memory for playback of a waveform sequence or a list sequence.

Key Path	Source, Modulation Setup, ARB, Select Waveform, Segments on Hard Disk
Notes	No remote command, SCPI front panel only.
Initial S/W Revision	A.05.00

Default Directory...

Allows you to change the default directory. It is used as a search location for waveform segments that are required to be loaded into ARB memory for playback of a waveform sequence, and as a search location for selecting waveforms using SCPI.

Key Path	Source, Modulation Setup, ARB, Select Waveform, Segments on Hard Disk
Remote Command	:SOURce:RADio:ARB:DEFault:DIRectory <string> :SOURce:RADio:ARB: DEFault:DIRectory?
Example	:SOUR:RAD:ARB:DEF:DIR "D:\ArbFiles" :SOUR:RAD:ARB:DEF:DIR?
State Saved	Persistent, survives a power cycle and a preset but not saved in the instrument state
Initial S/W Revision	A.05.00

Segments in ARB Memory

Allows you access to the sub-menus for managing the files within ARB memory.

Key Path	Source, Modulation Setup, ARB, Select Waveform
Initial S/W Revision	A.05.00

Delete Segment From ARB Mem

Allows you to remove a segment from ARB playback memory.

Key Path	Source, Modulation Setup, ARB, Select Waveform, Segments in ARB Memory
Remote Command	:SOURce:RADio:ARB:DELeTe <string>
Example	:SOUR:RAD:ARB:DEL "testwaveform.bin"
Notes	<p><string> - specifies the waveform to be deleted from the ARB playback memory.</p> <p>When in Sequence Analyzer mode and Include Source is Yes, an attempt to delete a file from ARB memory is rejected with an error.</p> <p>When Include Source is No and you specify a file that does not exist within ARB memory, an error is generated.</p> <p>It is possible to delete files from within the ARB memory when the ARB is ON. However, if you attempt to delete the file that is currently playing an error is generated.</p> <p>It is possible to delete a file from within the ARB memory when the sequencer state is ON and the file is not being used by the List Sequencer. If you attempt to delete a file which is being used by the list sequencer, an error is generated.</p> <p>When sequencer state is On, even if ARB state is On, the selected waveform will not be played. In this case, if the selected waveform is not used in List Sequence, it can be deleted and the ARB state is turned Off.</p> <p>If the ARB is ON and you load a file to ARB memory or delete a file from ARB memory, the playing waveform segment may not keep phase continuity during the ARB memory operation. The waveform will be replayed after the ARB operation is finished.</p>
Initial S/W Revision	A.05.00

Delete All From ARB Memory

Allows you to remove all segments from ARB playback memory.

Key Path	Source, Modulation Setup, ARB, Select Waveform, Segments in ARB Memory
Remote Command	:SOURce:RADio:ARB:DELeTe:ALL
Example	:SOUR:RAD:ARB:DELeTe:ALL
Notes	<p>When in Sequence Analyzer mode and Include Source is Yes, an attempt to delete all files from ARB memory is rejected with an error.</p> <p>When Include Source is No and you attempt to delete all files from ARB memory when the ARB is currently playing a file, all files except the one playing are deleted and an error is generated.</p> <p>If you attempt to delete all files from ARB memory when there are waveform files used in "List Sequencer" on page 2168 and "Sequencer" on page 2168 state is ON, all files except the files currently being used in list sequencer are deleted, and an error is generated.</p> <p>If the ARB is ON and you load a file to ARB memory or delete a file from ARB memory, the playing waveform segment may not keep phase continuity during the ARB memory operation. The waveform will be replayed after the ARB operation is finished.</p>
Initial S/W Revision	A.05.00

Step Duration

Allows access to the sub-menus for setting up the duration of play for the current step.

The duration can be set to be either the number of times for the ARB file associated with the sequence to play, or a specific time value, or continuous. If the step is set to play a CW tone, the step duration cannot be set to a play count.

Key Path	Source, List Sequencer, List Sequencer Setup
Remote Command	:SOURce:LIST:STEP[1] 2 3...1000:SETup:DURation:TYPE TIME COUNT CONTinuous CABort :SOURce:LIST:STEP[1] 2 3...1000:SETup:DURation:TYPE?
Example	:SOUR:LIST:STEP2:SET:DUR:TYPE TIME :SOUR:LIST:STEP2:SET:DUR:TYPE?
Notes	SCPI is supported after A.09.40
Notes	If “Step Duration” is set to “Time” or “Play Count” for the last step, the last step of ARB keeps playing as if set to “Continuous”, until the set “Time” has expired or until the “Play Count” setting is reached. However, you can query Error! Reference source not found. Source Sweeping Condition Message to find out if the current list sequence is complete or not.
Range	Time Play Count Continuous Continuous Abort
Initial S/W Revision	A.05.00

Time

Sets the duration of the current step to be a time value for the length of time the step will play. Pressing this key again opens another menu which allows you to set the time value for the step duration.

Key Path	Source, List Sequencer, List Sequencer Setup, Step Duration
Example	:SOUR:LIST:STEP2:SET:DUR:TYPE TIME
Notes	SCPI is supported after A.09.40
Initial S/W Revision	A.05.00

Duration Time

Allows you to specify the length of time the current step will play.

If the Transition Time value is longer than the Step Duration Time, an error is generated when initiating a source list sequence. For source list sequence, transition time is included in the step duration length (not occupy additional time). If the Transition Time value is longer than the Step Duration Time, the real step duration length is extended to equal the transition time and cause a timing shift. This check is also described in section **Error! Reference source not found.** List Sequence Step Validation.

Key Path	Source, List Sequencer, List Sequencer Setup, Step Duration, Time
Remote Command	:SOURce:LIST:STEP[1] 2 3...1000:SETup:DURation:TCOUNT <double> :SOURce:LIST:STEP[1] 2 3...1000:SETup:DURation:TCOUNT?

Example	:SOUR:LIST:STEP2:SET:DUR:TCO 1s :SOUR:LIST:STEP2:SET:DUR:TCO?
Notes	SCPI is supported after A.09.40 This SCPI is reused by "Play Count", "Duration Time" and "Continuous Abort" according to current Duration Type setting is "Play Count" or "Duration Time" or "Continuous Abort". If current "Duration Type" is "Continuous", then popup error -221, "Settings conflict;Cannot accept time or count input when step duration type is Continuous on step #"
Notes	If "Duration Time" is set for the last step, the last step of ARB keeps playing as if set to "Continuous" after set time expires. However, you can query Source Sweeping Condition Message (:STAT:OPER:COND?) to find out if the current list sequence is complete or not.
Preset	1.00 ms
Min	100 μs
Max	1800 s
Initial S/W Revision	A.05.00

Play Count

Sets the duration of the current step to be an integer value for the number of times (play count) the ARB file is selected for playback during this step. For example, a 5 second ARB will be set to play 5 times during the step.

Key Path	Source, List Sequencer, List Sequencer Setup, Step Duration
Example	:SOUR:LIST:STEP2:SET:DUR:TYPE COUN
Notes	SCPI is supported after A.09.40 This key is unavailable and is grayed out if the current step is configured to CW tone rather than an ARB waveform.
Initial S/W Revision	A.05.00

Header Utilities

Allows access to the header utilities sub-menu. Pressing this key also causes the central display area to change to display the File Header Information view.

Key Path	Source, Modulation Setup, ARB
Dependencies	This key is only available if there is currently a waveform selected for playback. If no waveform is selected, the key is grayed out.
Initial S/W Revision	A.05.00

Continuous

Sets the current step to be played continuously until the next step starts. The waveform will always play completely before transitioning to the next step.

Key Path	Source, List Sequencer, List Sequencer Setup, Step Duration
Example	:SOUR:LIST:STEP2:SET:DUR:TYPE CONT
Notes	SCPI is supported after A.09.40
Initial S/W Revision	A.05.00

Output Trigger

Allows you to specify the trigger output for the current step. The trigger output signal is sent at the start of the step.

When select “On”, trigger event will occur on both Internal and External2 paths. Select “Off” will turn off trigger output.

Key Path	Source, List Sequencer, List Sequencer Setup
Remote Command	:SOURce:LIST:STEP [1] 2 3...1000:SETup:OUTPut:TRIGger ON OFF 1 0 :SOURce:LIST:STEP [1] 2 3...1000:SETup:OUTPut:TRIGger
Example	:SOUR:LIST:STEP2:SET:OUTP:TRIG ON :SOUR:LIST:STEP2:SET:OUTP:TRIG?
Notes	SCPI is supported after A.09.40
Preset	Off
Range	On Off
Initial S/W Revision	A.05.00

Repetition

Allows access to the sub-menu for selecting the repetition type for the list sequencer globally. It cannot be changed between different sequence steps.

Key Path	Source, List Sequencer
Remote Command	:SOURce:LIST:REPetition:TYPE SINGLE CONTInuous
Example	:SOUR:LIST:REP:TYPE SING :SOUR:LIST:REP:TYPE?
Preset	SINGLE
Range	SINGLE CONTInuous
Initial S/W Revision	A.14.50

Single

Sets the repetition type as single for the whole source sequence. Source list will play one time after initiation.

Key Path	Source, List Sequencer, Repetition
Example	:SOUR:LIST:REP:TYPE SINGLE
Initial S/W Revision	A.14.50

Continuous

Sets the repetition type as continuous for the whole source sequence. Source list will play continuously after initiation.

Key Path	Source, List Sequencer, Repetition
Example	:SOUR:LIST:REP:TYPE CONTInuous
Initial S/W Revision	A.14.50

Trigger Type

Allows access to the sub-menu for selecting the output trigger type for the list sequencer globally. It cannot be changed between different sequence steps.

Key Path	Source, List Sequencer
Remote Command	:SOURce:LIST:TRIGgerout:TYPe BEGInningofstep DATAmarker
Example	:SOUR:LIST:TRIG:TYP BEG :SOUR:LIST:TRIG:TYP?
Notes	SCPI is supported after A.14.00
Preset	BEGInningofstep
Range	BEGInningofstep DATAmarker
Initial S/W Revision	A.14.00

BeginningOfStep

Sets the output trigger type as BeginningOfStep for the whole source sequence.

Key Path	Source, List Sequencer, Trigger Type
Example	:SOUR:LIST:TRIG:TYP BEG
Notes	SCPI is supported after A.14.00
Initial S/W Revision	A.14.00

DataMarker

Sets the output trigger type as DataMarker for the whole source sequence. When DataMarker is selected, which marker to route is also needed to be set.

Key Path	Source, List Sequencer, Trigger Type
Example	:SOUR:LIST:TRIG:TYP DAT
Notes	SCPI is supported after A.14.00
Initial S/W Revision	A.14.00

Marker 1

Sets the output trigger maker routing to Marker 1 for DataMarker in the whole source sequence.

Key Path	Source, List Sequencer, Trigger Type, DataMarker
Example	:SOUR:LIST:TRIG:TYPE:MARK M1
Notes	SCPI is supported after A.14.00
Initial S/W Revision	A.14.00

Marker 2

Sets the output trigger maker routing to Marker 2 for DataMarker in the whole source sequence.

Key Path	Source, List Sequencer, Trigger Type, DataMarker
Example	:SOUR:LIST:TRIG:TYPE:MARK M2
Notes	SCPI is supported after A.14.00
Initial S/W Revision	A.14.00

Marker 3

Sets the output trigger maker routing to Marker 3 for DataMarker in the whole source sequence.

Key Path	Source, List Sequencer, Trigger Type, DataMarker
Example	:SOUR:LIST:TRIG:TYPE:MARK M3
Notes	SCPI is supported after A.14.00
Initial S/W Revision	A.14.00

Marker 4

Sets the output trigger maker routing to Marker 4 for DataMarker in the whole source sequence.

Key Path	Source, List Sequencer, Trigger Type, DataMarker
Example	:SOUR:LIST:TRIG:TYPE:MARK M4
Notes	SCPI is supported after A.14.00
Initial S/W Revision	A.14.00

Manual Trigger Now

Pressing this key provides a software trigger event to the list sequencer. During execution of sequence, if the sequencer is halted on any step that has been configured with a “Manual” step trigger, then this key press will cause the sequencer to continue and execute the step.

Key Path	Source, List Sequencer
Remote Command	No remote command, front panel only.
Initial S/W Revision	A.05.00

Source Preset

Allows you to preset the source settings to their default values.

Key Path	Source
Remote Command	:SOURce:PRESet
Example	:SOUR:PRES

Span X Scale

Activates the Span function and displays the menu of span functions. The parameter values are measurement independent.

Key Path	Front-panel key
Initial S/W Revision	Prior to A.02.00

Span

Set the frequency of the occupied bandwidth span for the current measurement.

Key Path	Span X Scale
Mode	SA, WCDMA, C2K, WIMAX OFDMA, TD-SCDMA, 1xEVDO, ISDB-T, CMMB, LTE, LTETDD, BLUETOOTH, WLAN, MSR, LTEAFDD, LTEATDD
Remote Command	[:SENSe] :OBWidth:FREQuency:SPAN <freq> [:SENSe] :OBWidth:FREQuency:SPAN? [:SENSe] :OBWidth:FREQuency:SPAN:AUTO ON OFF 0 1 [:SENSe] :OBWidth:FREQuency:SPAN:AUTO?
Example	OBW:FREQ:SPAN 2.4 MHz OBW:FREQ:SPAN? OBW:FREQ:SPAN:AUTO 0 OBW:FREQ:SPAN:AUTO?
Notes	Span Auto Detector ([:SENSe] :OBWidth:FREQuency:SPAN:AUTO) is only available in MSR and LTE-Advanced FDD/TDD mode. The BAF SCPI is MSR and LTE-Advanced FDD/TDD only.
Couplings	When changing the Occupied Bandwidth Span, the Resolution Bandwidth and Video Bandwidth are set to AUTO to prevent the span from clipping. This is only available in MSR and LTE-Advanced FDD/TDD mode.
Preset	SA: 3 MHz WCDMA: 10 MHz WIMAX OFDMA: 20 MHz CDMA2K: 2 MHz TD-SCDMA: 4.8 MHz 1xEVDO: 3.75 MHz ISDB-T: 20 MHz CMMB: 8 MHz LTE, LTETDD, LTEAFDD, LTEATDD: 10 MHz BLUETOOTH:2 MHz WLAN: If Radio Std is 802.11a/g 802.11n(20MHz) 802.11ac(20MHz): 25 MHz If Radio Std is 802.11b: 30MHz

	If Radio Std is 802.11n(40MHz), 802.11ac (40MHz): 50 MHz If Radio Std is 802.11ac(80MHz): 100MHz If Radio Std is 802.11ac(160MHz): 200MHz MSR: 20MHz ON
State Saved	Saved in instrument state.
Min	100 Hz
Max	Hardware Maximum Span
Backwards Compatibility SCPI	[:SENSe] :EBWidth :FREQuency :SPAN
Initial S/W Revision	Prior to A.02.00
Modified at S/W Revision	A.03.00, A.10.00, A.14.00

Full Span

Changes the Occupied Bandwidth Span to show the full frequency range of the analyzer. When using external mixing, it changes the displayed frequency span to the frequency range specified for the selected external mixing band.

Key Path	Span X Scale
Mode	SA, WCDMA, C2K, WIMAX OFDMA, ISDB-T, CMMB, LTE, LTETDD, BLUETOOTH, WLAN, LTEAFDD, LTEATDD
Remote Command	[:SENSe] :OBWidth :FREQuency :SPAN :FULL
Example	OBW:FREQ:SPAN:FULL
Notes	You must be in the Spectrum Analysis mode, W-CDMA mode, ISDB-T mode, CMMB mode, LTE mode, LTE TDD mode, BLUETOOTH mode, WLAN mode, cdma2000 mode, MSR or WIMAX OFDMA mode to use this command. Use:INSTrument:SElect to set the mode.
Dependencies	For MSR and LTE-Advanced FDD/TDD mode, this key is blank. In order to keep backwards compatible with the legacy LTE FDD/TDD, the scpi command is supported in LTE & LTE-A converged application.
Couplings	Selecting full span changes the measurement span value.
Initial S/W Revision	Prior to A.02.00
Modified at S/W Revision	A.03.00

Last Span

Changes the measurement frequency span to previous measurement span setting. If there is no existing previous span value then the span remains unchanged.

Key Path	Span X Scale
----------	--------------

11 Occupied Bandwidth Measurement
Span X Scale

Mode	SA, WCDMA, C2K, WIMAX OFDMA, ISDB-T, CMMB, LTE, LTETDD, BLUETOOTH, WLAN, MSR, LTEAFDD, LTEATDD
Remote Command	[:SENSe] :OBWidth:FREQuency:SPAN:PREvious
Example	OBW:FREQ:SPAN:PREV
Notes	You must be in the Spectrum Analysis mode, W-CDMA mode, ISDB-T mode, CMMB mode, LTE mode, LTE TDD mode, BLUETOOTH mode, WLAN mode, cdma2000 mode, MSR, LTE-Advanced FDD/TDD or WIMAX OFDMA mode to use this command. Use:INSTrument:SElect to set the mode.
Couplings	Selecting last span changes the measurement span value.
Initial S/W Revision	Prior to A.02.00
Modified at S/W Revision	A.03.00

Sweep/Control

Displays a menu of functions that enable you to set up and control the sweep time and source for the current measurement.

For details about this key, see Sweep/Control.

Key Path	Front-panel key
Initial S/W Revision	Prior to A.02.00

Sweep Time

Selects the length of time in which the spectrum analyzer sweeps the displayed frequency span. Additional overhead time, which impacts the sweep rate, is not calculated as part of the sweep time. In fact:

- sweep rate = span/sweep time
- update rate = 1/(sweep time + overhead)
- sweep cycle time = sweep time + overhead

Sweep time is coupled to RBW and VBW, and is impacted by the number of sweep points, so changing those parameters may change the sweep time.

This function is not available when the selected input is I/Q.

Key Path	Sweep/Control
Mode	SA, WCDMA, C2K, WIMAX OFDMA, TD-SCDMA, 1xEVDO, ISDB-T, CMMB, LTE, LTETDD, BLUETOOTH, WLAN, MSR, LTEAFDD, LTEATDD
Remote Command	[:SENSe]:OBWidth:SWEep:TIME <time> [:SENSe]:OBWidth:SWEep:TIME? [:SENSe]:OBWidth:SWEep:TIME:AUTO OFF ON 0 1 [:SENSe]:OBWidth:SWEep:TIME:AUTO?
Example	OBW:SWE:TIME 50 ms OBW:SWE:TIME? OBW:SWE:TIME:AUTO ON OBW:SWE:TIME:AUTO?
Couplings	When you manually change the Time, this state automatically goes to 'Man'.
Preset	SA, WIMAX OFDMA, C2K, TD-SCDMA, 1xEVDO, ISDB-T, CMMB, LTE, LTETDD, BLUETOOTH, WLAN, MSR, LTEAFDD, LTEATDD: Automatically Calculated WCDMA: 32.6 ms SA, WIMAX OFDMA, C2K, TD-SCDMA, 1xEVDO, ISDB-T, CMMB, LTE, LTETDD, WLAN, MSR, LTEAFDD, LTEATDD: ON WCDMA: OFF
State Saved	Saved in instrument state.

Min	1 ms
Max	4000 s
Initial S/W Revision	Prior to A.02.00
Modified at S/W Revision	A.03.00

Sweep Setup

Accesses the sweep setup settings for the current measurement.

Key Path	Sweep/Control
Initial S/W Revision	Prior to A.02.00

Auto Sweep Time Rules

Switches the analyzer between normal and accuracy sweep states.

Setting Auto Sweep Time to Accy results in slower sweep times, usually about three times as long, but better amplitude accuracy for CW signals. The instrument amplitude accuracy specifications only apply when Auto Sweep Time is set to Accy.

Additional amplitude errors which occur when Auto Sweep Time is set to Norm are usually well under 0.1 dB, though this is not guaranteed. Because of the faster sweep times and still low errors, Norm is the preferred setting of Auto Sweep Time. Auto Sweep Time is set to Norm on a Preset or Auto Couple. This means that in the Preset or Auto Coupled state, instrument amplitude accuracy specifications do not apply.

Key Path	Sweep/Control, Sweep Setup
Mode	SA, WCDMA, C2K, WIMAX OFDMA, TD-SCDMA, 1xEVDO, ISDB-T, CMMB, LTE, LTETDD, BLUETOOTH, WLAN, MSR, LTEAFDD, LTEATDD
Remote Command	[:SENSe] :OBWidth :SWEep :TIME :AUTO :RULes NORMal ACCuracy [:SENSe] :OBWidth :SWEep :TIME :AUTO :RULes ?
Example	OBW:SWE:TIME:AUTO:RUL NORM OBW:SWE:TIME:AUTO:RUL ?
Notes	Set to Norm when Auto Couple is pressed or sent remotely.
Preset	NORMal
State Saved	Saved in instrument state.
Range	Norm Accy
Initial S/W Revision	Prior to A.02.00
Modified at S/W Revision	A.03.00

Pause

Pauses the measurement after the current data acquisition is complete.

When Paused, the label on the key changes to Resume. Pressing Resume resumes the measurement at the point where it had been paused.

See Pause/Resume for more information.

Key Path	Sweep/Control
Initial S/W Revision	Prior to A.02.00

Gate

Accesses a menu that enables you to control the gating function. The Gate functionality is used to view signals best viewed by qualifying them with other events.

Gate setup parameters are the same for all measurements – they do not change as you change measurements. Settings like these are called “Meas Global” and are unaffected by Meas Preset.

Key Path	Sweep/Control
Scope	Meas Global
Readback	The state and method of Gate, as [Off, FFT] or [On, FFT]. Note that for measurements that only support gated FFT, the method is nonetheless read back, but always as FFT.
Initial S/W Revision	Prior to A.02.00

Gate On/Off

Turns the gate function on and off.

When the Gate Function is on, the selected Gate Method is used along with the gate settings and the signal at the gate source to control the sweep system with the gate signal. Not all measurements allow every type of Gate Methods.

When Gate is on, the annunciation in the measurement bar reflects that it is on and what method is used, as seen in the following "Gate: FFT" annunciator graphic.

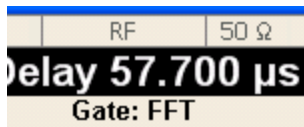

Key Path	Sweep/Control, Gate
Remote Command	[:SENSe] :SWEep:EGATe [:STATe] OFF ON 0 1 [:SENSe] :SWEep:EGATe [:STATe] ?

Example	SWE:EGAT ON SWE:EGAT?
Dependencies	<p>When in the ACP measurement:</p> <ul style="list-style-type: none"> • When Meas Method is RBW or FAST, this function is unavailable and the key is grayed out. • Whenever Gate is on, Meas Method, RBW or FAST is unavailable and keys for those are grayed out. • When Gate is on, Offset Res BW and Offset Video BW are ignored (if you set these values) and the measurement works as if all Offset Res BW and all Offset Video BW are coupled with the Res BW and the Video BW under the BW menu. When Gate is on, the Offset BW key in the Offset/Limit menu is grayed out.
Preset	Off LTETDD: On
State Saved	Saved in instrument state
Range	On Off
Backwards Compatibility SCPI	[:SENSe]:SWEep:TIME:GATE[:STATe] ESA compatibility
Backwards Compatibility Notes	In ESA, Trig Delay (On) and Gate (On) could not be active at the same time.. This dependency does not exist in PSA or in the X-Series.
Initial S/W Revision	Prior to A.02.00

Gate View On/Off

Turning on Gate View in the Swept SA measurement provides a single-window gate view display..

Turning on Gate View in other measurements shows the split-screen Gate View. In these measurements, when the Gate View is on, the regular view of the current measurement traces and results are reduced vertically to about 70% of the regular height. The Zero Span window, showing the positions of the Gate, is shown between the Measurement Bar and the reduced measurement window. By reducing the height of the measurement window, some of the annotation on the Data Display may not fit and is not shown.

Key Path	Sweep/Control, Gate
Remote Command	[:SENSe]:SWEep:EGATe:VIEW ON OFF 1 0 [:SENSe]:SWEep:EGATe:VIEW?
Example	SWE:EGAT:VIEW ON turns on the gate view.
Dependencies	<p>In the Swept SA measurement:</p> <p>In Gate View, the regular Acq Time key is grayed out . When pressed, the grayed out key puts up the informational message "Use Gate View Sweep Time in the Gate menu."</p> <p>In the other measurements:</p> <p>When you turn Gate View on, the lower window takes on the current state of the instrument. Upon leaving Gate View, the instrument takes on the state of the lower window.</p> <p>When you turn Gate View on, the upper window Acquisition Time is set to the gate view acquisition time.</p>

Couplings	<p>These couplings apply to the Swept SA measurement:</p> <ul style="list-style-type: none"> • When Gate View is turned on, the instrument is set to Zero Span. • Gate View automatically turns off whenever a Span other than Zero is selected. • Gate View automatically turns off if you press the Last Span key while in Gate View, and the instrument returns to the Span it was in before entering Gate View (even if that is Zero Span). • When Gate View is turned on, the sweep time used is the gate view sweep time. This is set according to the rules in section "Gate View Setup" on page 1437 • When Gate View is turned off, Sweep Time is set to the normal Swept SA measurement sweep time. • If Gate View is on and Gate is off, then turning on Gate turns off Gate View.
Preset	OFF
State Saved	Saved in instrument state
Range	On Off
Initial S/W Revision	Prior to A.02.00

A sample of the Gate View screen in the Swept SA measurement is shown in the following graphic :

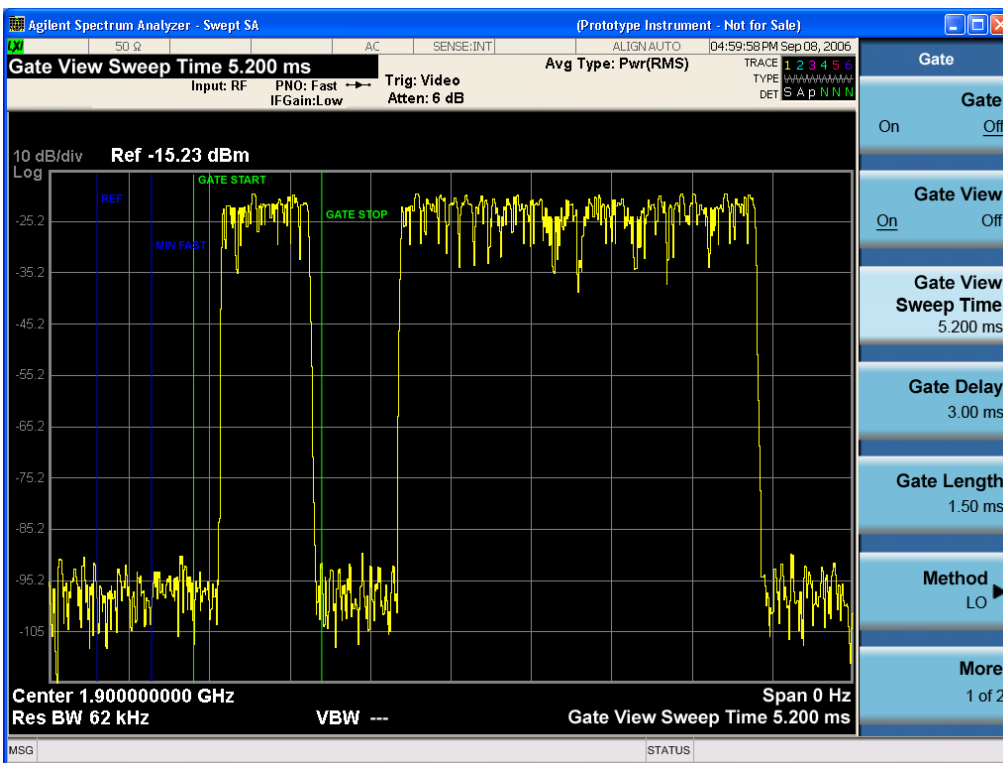

A sample of the Gate View screen in other measurements is shown in the following graphic . This example is for the ACP measurement:

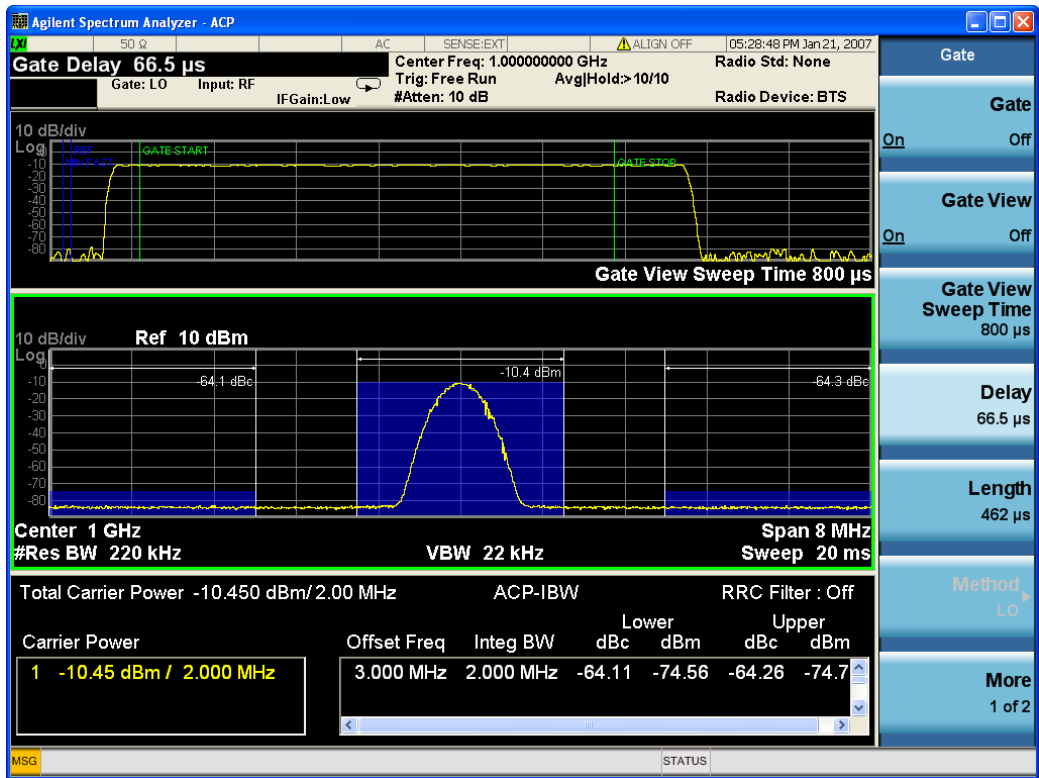

Turning Gate View off returns the analyzer to the Normal measurement view.

In the Swept SA, the normal measurement view is the single-window Swept SA view. When returning to this view, the Swept SA measurement returns to the Span it was in before entering **Gate View** (even if that is Zero Span).

The **Gate View** window is triggered from the Gate Source, with zero trigger delay. Also, when updating the **Gate View** window, the Gate itself must not operate. So it is internally shut off while the gate view window is being updated. For the Swept SA measurement, this means that the Gate is internally shut off whenever the gate view window is displayed. The measurement bar and softkeys continue to show the Trigger source for the main sweep window and give no indication that the Gate is shut off or that the Gate View window is triggered from the Gate Source.

When in **Gate View**, vertical lines are displayed in the Gate View window as follows:

- Green lines are displayed at the gate edges as follows: in Edge Gate, a line is shown for Delay and one for the end of the Gate period, defined by Length. You can adjust the position of the green lines by adjusting the gate length and the gate delay. These lines update in the Gate View window as the active function changes, even if the window is not being updated. In Gated FFT, their location is relative to the left edge of the screen.
- A blue line is displayed showing the delay reference, that is, the reference point for the Gate Delay within the Zero Span window. The blue line represents where (in time) the effective location of the gate start would be if the gate were programmed to zero delay.

Gate View Setup

Accesses a menu that enables you to setup parameters relevant to the Gate View

Key Path	Sweep/Control, Gate
Scope	Meas Global
Initial S/W Revision	A.10.00

Gate View Acquisition Time

Controls the acquisition time in the Gate View window. To provide an optimal view of the gate signal, the analyzer initializes Gate View Acq Time based on the current settings of Gate Delay and Gate Length.

Key Path	Sweep/Control, Gate, Gate View Setup
Remote Command	[:SENSe] :SWEep:EGATe:TIME <time> [:SENSe] :SWEep:EGATe:TIME?
Example	SWE:EGAT:TIME 500 ms
Dependencies	Gate View Acquisition Time is initialized: <ul style="list-style-type: none"> • On Preset (after initializing delay and length). • Every time the Gate Method is set/changed. <ol style="list-style-type: none"> 1. Compute the location of the "gate stop" line, which you know is at time $t = t_{min} + \text{GateDelay} + \text{GateLength}$.
Preset	519.3 μ s WiMAX OFDMA: 5 ms GSM/EDGE: 1 ms
State Saved	Saved in instrument state
Min	100 ns
Max	6000 s
Initial S/W Revision	Prior to A.02.00

Gate View Start Time

Controls the time at the left edge of the Gate View.

Key Path	Sweep/Control, Gate, Gate View Setup
Remote Command	[:SENSe] :SWEep:EGATe:VIEW:STARt <time> [:SENSe] :SWEep:EGATe:VIEW:STARt?
Example	SWE:EGAT:VIEW:STAR 10ms
Notes	Units of time are required or no units; otherwise an invalid suffix error message will be generated. See error -131.

Preset	0 ms
State Saved	Saved in instrument state
Min	0
Max	500 ms
Initial S/W Revision	A.10.00

Gate Delay

Controls the length of time from the time the gate condition goes True until the gate is turned on.

Key Path	Sweep/Control, Gate
Remote Command	[:SENSe] :SWEep:EGATe:DELay <time> [:SENSe] :SWEep:EGATe:DELay?
Example	SWE:EGAT:DELay 500ms SWE:EGAT:DELay?
Notes	Units of time are required or no units; otherwise an invalid suffix error message will be generated.
Preset	57.7 us WiMAX OFDMA: 71 us GSM/EDGE: 600 us WLAN: 500 us WLAN: 36 us
State Saved	Saved in instrument state
Min	0.0 us
Max	100 s
Backwards Compatibility SCPI	[:SENSe] :SWEep:TIME:GATE:DELay ESA compatibility
Initial S/W Revision	Prior to A.02.00

Gate Length

Controls the length of time that the gate is on after it opens.

Key Path	Sweep/Control, Gate
Remote Command	[:SENSe] :SWEep:EGATe:LENGth <time> [:SENSe] :SWEep:EGATe:LENGth?
Example	SWE:EGAT:LENG 1 SWE:EGAT:LENG?

Notes	Units of time are required or no units; otherwise an invalid suffix error message will be generated.
Preset	461.6 us WiMAX OFDMA: 50 us GSM/EDGE: 200 us WLAN: 1.54 ms WLAN: 32 us
State Saved	Saved in instrument state
Min	100 ns
Max	5 s
Backwards Compatibility SCPI	[:SENSe]:SWEep:TIME:GATE:LENGth ESA compatibility
Initial S/W Revision	Prior to A.02.00

Gate Source

The menus under the Gate Source key are the same as those under the Trigger key, with the exception that neither Free Run nor Video are available as Gate Source selections. However, a different SCPI command is used to select the Gate Source (see table below) because you may independently set the Gate Source and the Trigger Source.

Any changes to the settings in the setup menus under each Gate Source selection key (for example: Trigger Level, Trigger Delay, etc.) also affect the corresponding settings under the Trigger menu keys. The SCPI commands used for these are the same for Trigger and Gate, since there is only one setting which affects both Gate and Trigger. Example: to set the Trigger Level for External 1 you use the command :TRIG:EXT1:LEV regardless of whether you are using External 1 as a Trigger Source or a Gate Source.

Key Path	Sweep/Control, Gate
Remote Command	[:SENSe]:SWEep:EGATe:SOURce EXTernal1 EXTernal2 LINE FRAME RFBurst [:SENSe]:SWEep:EGATe:SOURce?
Dependencies	In some models, there is no second External input. In these models, the External 2 key is blanked and the EXTernal2 parameter will generate a "Hardware missing; Not available for this model number" error.
Preset	EXTernal 1 GSM/EDGE, MSR: FRAME LTETDD: EXTernal 1When Direction is Downlink, FRAME when Direction is Uplink.
Initial S/W Revision	Prior to A.02.00
Modified at S/W Revision	A.03.00, A.14.00

Video (IF Envelope)

Pressing this key, when it is not selected, selects the video signal as the trigger. The Video trigger condition is met when the video signal (the filtered and detected version of the input signal, including both RBW and VBW filtering) crosses the video trigger level.

NOTE

When the detector selected for all active traces is the average detector, the video signal for triggering does not include any VBW filtering.

The video trigger level is shown as a labeled line on the display. The line is displayed as long as video is the selected trigger source.

Pressing this key, when it is already selected, accesses the video trigger setup functions.

Key Path	Trigger
Example	TRIG:SOUR VID Swept SA measurement TRIG:<meas>:SOUR VID Measurements other than Swept SA
Notes	Log Plot and Spot Frequency measurements do not support Video Trigger
Dependencies	Video trigger is allowed in average detector mode.
State Saved	Saved in instrument state
Status Bits/OPC dependencies	The Status Operation Register bit 5 "Waiting for Trigger" is set at the same time as the Sweeping or Measuring bit is set. It is cleared when the trigger actually occurs (that is, after the trigger event occurs and all the applicable trigger criteria have been met). A corresponding pop-up message ("Waiting for trigger") is generated if no trigger signal appears after approximately 2 sec. This message goes away when a trigger signal appears.
Backwards Compatibility Notes	In the past, the Average detector was not available when Video triggering was on, and consequently, functions that set the detector to average (such as Marker Noise or Band/Intvl Power) were not available when the video trigger was on. Similarly, Video triggering was not available when the detector was Average. In the X-Series, these restrictions are removed.
Initial S/W Revision	Prior to A.02.00

Trigger Level

Sets a level for the video signal trigger. When the video signal crosses this level, with the chosen slope, the trigger occurs. This level is displayed with a horizontal line only if **Video** is the selected trigger source.

Key Path	Trigger, Video
Remote Command	:TRIGger[:SEquence]:VIDeo:LEVel <ampl> :TRIGger[:SEquence]:VIDeo:LEVel?
Example	TRIG:VID:LEV -40 dBm
Notes	When sweep type = FFT, the video trigger uses the amplitude envelope in a bandwidth wider than the FFT width as a trigger source. This might often be useful, but does not have the same relationship between the displayed trace and the trigger level as in swept triggering. Amplitude Corrections are not taken into account by the Video Trig Level. For example, if you have given yourself effective gain with an amplitude correction factor, the Video Trigger will not fire until

you have dropped the trigger line that far below the displayed signal level, rather than simply dropping it down to the displayed signal level.
Note that other corrections, specifically External Gain and Ref Level Offset, modify the actual trace data as it is taken and therefore ARE taken into account by Trig Level.

Couplings	This same level is used for the Video trigger source in the Trigger menu and for the Video selection in the Gate Source menu.
Preset	Set the Video Trigger Level -25 dBm on Preset. When the Video Trigger Level becomes the active function, if the value is off screen, set it to either the top or bottom of screen, depending on which direction off screen it was.
State Saved	Saved in instrument state
Min	-170 dBm
Max	+30 dBm
Default Unit	Depends on the current selected Y axis unit
Backwards Compatibility SCPI	:TRIGger[:SEQuence]:IF:LEVel :TRIGger[:SEQuence]:IF:LEVel?
Backwards Compatibility Notes	This alias is provided for backward compatibility with VSA/PSA comms apps.
Initial S/W Revision	Prior to A.02.00

Trig Slope

Controls the trigger polarity. It is set positive to trigger on a rising edge and negative to trigger on a falling edge.

Key Path	Trigger, Video
Remote Command	:TRIGger[:SEQuence]:VIDeo:SLOPe POSitive NEGative :TRIGger[:SEQuence]:VIDeo:SLOPe?
Example	TRIG:VID:SLOP NEG
Preset	POSitive
State Saved	Saved in instrument state
Backwards Compatibility SCPI	:TRIGger[:SEQuence]:IF:SLOPe NEGative POSitive :TRIGger[:SEQuence]:IF:SLOPe? For backward compatibility with VSA/PSA comms apps
Backwards Compatibility Notes	The legacy :TRIGger[:SEQuence]:SLOPe command affects the slopes for the VID, LINE, EXT1, EXT2, and RFB triggers.
Initial S/W Revision	Prior to A.02.00
Remote Command	:TRIGger[:SEQuence]:SLOPe POSitive NEGative

	:TRIGger[:SEquence]:SLOPe?
Example	TRIG:SLOP NEG
Preset	POSitive
State Saved	Saved in instrument state
Backwards Compatibility Notes	In ESA/PSA, the Trigger Slope was global to all triggers. In the X-Series, the slope can be set individually for each Trigger Source. For backward compatibility, the global SLOPe command updates all instances of trigger slope (VID, LINE, EXT1, EXT2, TV, RFB). The query returns the trigger slope setting of the currently selected trigger source.
Initial S/W Revision	Prior to A.02.00

External 1

Pressing this key, when it is not selected, selects an external input signal as the trigger. A new sweep/measurement will start when the external trigger condition is met using the external 1 input connector on the rear panel.

Pressing this key, when it is already selected, accesses the external 1 trigger setup menu.

Key Path	Trigger
Example	TRIG:SOUR EXT1 Swept SA measurement TRIG:<meas>:SOUR EXT1 Measurements other than Swept SA
Dependencies	Grayed out if in use by Point Trigger in the Source Setup menu. Forced to Free Run if already selected and Point Trigger is set to External 1.
State Saved	Saved in instrument state
Status Bits/OPC dependencies	The Status Operation Register bit 5 "Waiting for Trigger" is set at the same time as the Sweeping or Measuring bit is set. It is cleared when the trigger actually occurs (that is, after the trigger event occurs and all the applicable trigger criteria have been met). A corresponding pop-up message ("Waiting for trigger") is generated if no trigger signal appears after approximately 2 sec. This message goes away when a trigger signal appears.
Initial S/W Revision	Prior to A.02.00

Trigger Level

Sets the value where the external 1 trigger input will trigger a new sweep/measurement.

Key Path	Trigger, External 1
Remote Command	:TRIGger[:SEquence]:EXTernal1:LEVel <level> :TRIGger[:SEquence]:EXTernal1:LEVel?
Example	TRIG:EXT1:LEV 0.4 V
Couplings	This same level is used for the Ext1 trigger source in the Trigger menu, for the Ext1 selection in the Periodic Timer sync source (in the Trigger menu and in the Gate Source menu), and also for the Ext1

	selection in the Gate Source menu.
Preset	1.2 V
State Saved	Saved in instrument state
Min	-3.5V
Max	3.5V
Default Unit	V
Backwards Compatibility SCPI	:TRIGger[:SEquence]:EXTernal:LEVel For backward compatibility, the parameter EXTernal is mapped to EXTernal1
Backwards Compatibility SCPI	:TRIGger[:SEquence]:FRAMe:EXTernal1:LEVel
Initial S/W Revision	Prior to A.02.00

Trig Slope

Controls the trigger polarity. It is set positive to trigger on a rising edge and negative to trigger on a falling edge.

Key Path	Trigger, External 1
Remote Command	:TRIGger[:SEquence]:EXTernal1:SLOPe POSitive NEGative :TRIGger[:SEquence]:EXTernal1:SLOPe?
Example	TRIG:EXT1:SLOP NEG
Couplings	This same slope is used in the Ext1 selection for the trigger source in the Trigger menu and for the period timer sync source (in the Trigger menu and in the Gate Source menu).
Preset	POSitive
State Saved	Saved in instrument state
Backwards Compatibility SCPI	:TRIGger[:SEquence]:EXTernal:SLOPe For backward compatibility, the parameter EXTernal is mapped to EXTernal1
Backwards Compatibility SCPI	:TRIGger[:SEquence]:FRAMe:EXTernal1:SLOPe
Backwards Compatibility Notes	The legacy :TRIGger[:SEquence]:SLOPe command affects the slopes for the VID, LINE, EXT1, EXT2, and RFB triggers.
Initial S/W Revision	Prior to A.02.00

Zero Span Delay Comp On/Off

In zero span, there is a natural delay in the signal path, which comes from the RBW filter. This is usually desirable, as it allows you to trigger on events and also see those events, because the signal is delayed from the trigger event. However, in some cases it is desirable to eliminate this delay, so that trigger

events line up exactly with the zero time point in zero span. You can use the Zero Span Delay Comp On/Off feature to enable or disable zero span delay compensation.

Key Path	Trigger, External 1
Remote Command	:TRIGger[:SEquence]:EXTernal1:DELay:COMPensation OFF ON 0 1 :TRIGger[:SEquence]:EXTernal1:DELay:COMPensation?
Example	TRIG:EXT1:DEL:COMP ON
Dependencies	No effect except in zero-span, but not locked out in nonzero spans. Blanked in modes that do not support zero-span measurements. If the SCPI command is sent when the key is blanked, an error is returned: -221, "Settings conflict; Feature not supported for this measurement" In analyzers shipping N9060A, this feature requires N9060A-7FP.
Preset	OFF
State Saved	Saved in instrument state
Initial S/W Revision	A.11.00

External 2

Pressing this key, when it is not selected, selects an external input signal as the trigger. A new sweep/measurement will start when the external trigger condition is met using the external 2 input connector. The external trigger 2 input connector is on the rear panel.

Pressing this key, when it is already selected, accesses the external 2 trigger setup menu.

Key Path	Trigger
Example	TRIG:SOUR EXT2 Swept SA measurement TRIG:<meas>:SOUR EXT2 Measurements other than Swept SA
Dependencies	In some models, there is no second External input. In these models, the External 2 key is blanked and the EXTernal2 parameter will generate a "Hardware missing; Not available for this model number" message. Grayed out if in use by Point Trigger in the Source Setup menu. Forced to Free Run if already selected and Point Trigger is set to External 2.
State Saved	Saved in instrument state
Status Bits/OPC dependencies	The Status Operation Register bit 5 "Waiting for Trigger" is set at the same time as the Sweeping or Measuring bit is set. It is cleared when the trigger actually occurs (that is, after the trigger event occurs and all the applicable trigger criteria have been met). A corresponding pop-up message ("Waiting for trigger") is generated if no trigger signal appears after approximately 2 sec. This message goes away when a trigger signal appears.
Initial S/W Revision	Prior to A.02.00
Modified at S/W Revision	A.03.00

Trigger Level

Sets the value where the external 2 trigger input will trigger a new sweep/measurement.

Key Path	Trigger, External 2
Remote Command	:TRIGger[:SEquence]:EXTernal2:LEVel :TRIGger[:SEquence]:EXTernal2:LEVel?
Example	TRIG:EXT2:LEV 1.1 V
Couplings	This same level is used for the Ext2 trigger source in the Trigger menu, for the Ext2 selection in the Periodic Timer sync source (in the Trigger menu and in the Gate Source menu), and also for the Ext2 selection in the Gate Source menu.
Preset	1.2 V
State Saved	Saved in instrument state
Min	-3.5V
Max	3.5V
Default Unit	V
Backwards Compatibility SCPI	:TRIGger[:SEquence]:FRAMe:EXTernal2:LEVel
Initial S/W Revision	Prior to A.02.00

Trig Slope

Controls the trigger polarity. It is set positive to trigger on a rising edge and negative to trigger on a falling edge.

Key Path	Trigger, External 2
Remote Command	:TRIGger[:SEquence]:EXTernal2:SLOPe POSitive NEGative :TRIGger[:SEquence]:EXTernal2:SLOPe?
Example	TRIG:EXT2:SLOP NEG
Couplings	This same slope is used in the Ext2 selection for the trigger source in the Trigger menu and for the period timer sync source (in the Trigger menu and in the Gate Source menu).
Preset	POSitive
State Saved	Saved in instrument state
Backwards Compatibility SCPI	:TRIGger[:SEquence]:FRAMe:EXTernal2:SLOPe
Backwards Compatibility Notes	The legacy :TRIGger[:SEquence]:SLOPe command affects the slopes for the VID, LINE, EXT1, EXT2, and RFB triggers.
Initial S/W Revision	Prior to A.02.00

Zero Span Delay Comp On/Off

In zero span, there is a natural delay in the signal path, which comes from the RBW filter. This is usually desirable, as it allows you to trigger on events and also see those events, because the signal is delayed from the trigger event. However, in some cases it is desirable to eliminate this delay, so that trigger events line up exactly with the zero time point in zero span. You can use the Zero Span Delay Comp On/Off feature to enable or disable zero span delay compensation.

Key Path	Trigger, External 2
Remote Command	:TRIGger[:SEquence]:EXTernal2:DELay:COMPensation OFF ON 0 1 :TRIGger[:SEquence]:EXTernal2:DELay:COMPensation?
Example	TRIG:EXT2:DEL:COMP ON
Dependencies	No effect except in zero-span, but not locked out in nonzero spans. Blanked in modes that do not support zero-span measurements. If the SCPI command is sent when the key is blanked, an error is returned: -221, "Settings conflict; Feature not supported for this measurement" In analyzers shipping N9060A, this feature requires N9060A-7FP.
Preset	OFF
State Saved	Saved in instrument state
Initial S/W Revision	A.11.00

RF Burst

Pressing this key, when it is not selected, selects the RF Burst as the trigger. A new sweep/measurement will start when an RF burst envelope signal is identified from the signal at the RF Input connector. Pressing this key, when it is already selected, accesses the RF Burst trigger setup menu.

In some models, a variety of burst trigger circuitry is available, resulting in various available burst trigger bandwidths. The analyzer automatically chooses the appropriate trigger path based on the hardware configuration and other settings of the analyzer.

Key Path	Trigger
Example	TRIG:SOUR RFB Swept SA measurement TRIG:<meas>:SOUR RFB Measurements other than Swept SA
State Saved	Saved in instrument state
Status Bits/OPC dependencies	The Status Operation Register bit 5 "Waiting for Trigger" is set at the same time as the Sweeping or Measuring bit is set. It is cleared when the trigger actually occurs (that is, after the trigger event occurs and all the applicable trigger criteria have been met). A corresponding pop-up message ("Waiting for trigger") is generated if no trigger signal appears after approximately 2 sec. This message goes away when a trigger signal appears.
Backwards Compatibility Notes	The legacy command: :TRIGger[:SEquence]:RFBurst:FSElectivity[:STATe] OFF ON 0 1 is not supported in the X-Series, as the hardware to do Frequency Selective burst triggers does not exist in X-Series.

Initial S/W Revision	Prior to A.02.00
Modified at S/W Revision	A.04.00

Absolute Trigger Level

Sets the absolute trigger level for the RF burst envelope.

When using the External Mixing path, the Absolute Trigger Level is uncalibrated because the factory default was set to accommodate the expected IF levels for the RF path.

Key Path	Trigger, RF Burst
Scope	Meas Global
Remote Command	:TRIGger[:SEquence]:RFBurst:LEVel:ABSolute <ampl> :TRIGger[:SEquence]:RFBurst:LEVel:ABSolute?
Example	TRIG:RFB:LEV:ABS 10 dBm sets the trigger level of the RF burst envelope signal to the absolute level of 10 dBm
Notes	Sending this command does not switch the setting from relative to absolute; to switch it you need to send the :TRIGger[:SEquence]:RFBurst:LEVel:TYPE command, below. Amplitude Corrections are not taken into account by the Absolute Trigger Level. For example, if you have given yourself effective gain with an amplitude correction factor, the Absolute Trigger will not fire until you have set the trigger level that far below the displayed signal level, rather than simply to the displayed signal level. This is only true for Amplitude Corrections, not External Gain or Ref Level Offset functions. If mode is Bluetooth, the default value is -50 dBm.
Couplings	This same level is used for the RF Burst trigger source in the Trigger menu, for the RF Burst selection in the Periodic Timer sync source (in the Trigger menu and in the Gate Source menu), and also for the RF Burst selection in the Gate Source menu
Preset	-20 dBm
State Saved	Saved in instrument state
Min	-200 dBm
Max	100 dBm
Default Unit	depends on the current selected Y-Axis unit
Backwards Compatibility SCPI	:TRIGger[:SEquence]:FRAME:RFBurst:LEVel:ABSolute
Initial S/W Revision	Prior to A.02.00
Modified at S/W Revision	A.04.00

Key Path	Trigger, RF Burst
Remote Command	:TRIGger[:SEquence]:RFBurst:LEVel:TYPE ABSolute RELative :TRIGger[:SEquence]:RFBurst:LEVel:TYPE?

Example	TRIG:RFB:LEV:TYPE REL sets the trigger level type of the RF burst trigger to Relative.
Preset	ABSolute
State Saved	Saved in instrument state
Initial S/W Revision	Prior to A.02.00
Modified at S/W Revision	A.04.00

Relative Trigger Level

Sets the relative trigger level for the RF burst envelope.

In some models, the relative burst trigger function is implemented in hardware. In other models, without the advanced triggering hardware required, the relative burst trigger function is implemented in software in some measurements, and is unavailable in other measurements.

When implemented in software, the relative RF Burst trigger function is implemented as follows:

1. The measurement starts with the absolute RF Burst trigger setting. If it cannot get a trigger with that level, auto trigger fires and the acquisition starts anyway. After the acquisition, the measurement searches for the peak in the acquired waveform and saves it.
2. Now, in the next cycle of the measurement, the measurement determines a new absolute RF Burst level based on the peak value from the first measurement and the Relative RF Burst Trigger Level (always 0 or negative dB) set by the user. The following formula is used:
3. absolute RF Burst level = peak level of the previous acquisition + relative RF Burst level
4. If the new absolute RF Burst level differs from the previous by more than 0.5 dB, the new level is sent to the hardware; otherwise it is not updated (to avoid slowing down the acquisition)

Steps 2 and 3 repeat for subsequent measurements.

Key Path	Trigger, RF Burst
Scope	Meas Global
Remote Command	:TRIGger[:SEquence]:RFBurst:LEVel:RELative <rel_amp1> :TRIGger[:SEquence]:RFBurst:LEVel:RELative?
Example	TRIG:RFB:LEV:REL -10 dB sets the trigger level of the RF burst envelope signal to the relative level of -10 dB
Notes	Sending this command does not switch the setting from absolute to relative; to switch it you need to send the :TRIGger[:SEquence]:RFBurst:LEVel:TYPE command, above. The relative trigger level is not available in some measurements. In those measurements the RELative parameter, and the :TRIGger[:SEquence]:RFBurst:LEVel:TYPE command (above), will generate an error if sent.
Dependencies	This key is grayed out and Absolute Trigger Level selected if the required hardware is not present in your analyzer and the current measurement does not support Relative triggering.
Preset	-6 dB

	GSM: -25 dB
State Saved	Saved in instrument state
Min	-45 dB
Max	0 dB
Default Unit	dB or dBc
Backwards Compatibility SCPI	:TRIGger[:SEquence]:RFBurst:LEVel
	This legacy command is aliased to :TRIGger[:SEquence]:RFBurst:LEVel:RELative because the PSA had ONLY relative burst triggering
Initial S/W Revision	Prior to A.02.00
Modified at S/W Revision	A.04.00

Trigger Slope

It is set positive to trigger on a rising edge and negative to trigger on a falling edge.

Key Path	Trigger, RF Burst
Remote Command	:TRIGger[:SEquence]:RFBurst:SLOPe POSitive NEGative :TRIGger[:SEquence]:RFBurst:SLOPe?
Example	TRIG:RFB:SLOP NEG
Couplings	This same slope is used in the RF Burst selection for the trigger source in the Trigger menu and for the period timer sync source (in the Trigger menu and in the Gate Source menu).
Preset	POSitive
State Saved	Saved in instrument state
Backwards Compatibility SCPI	:TRIGger[:SEquence]:FRAMe:RFBurst:SLOPe
Backwards Compatibility Notes	The legacy :TRIGger[:SEquence]:SLOPe command affects the slopes for the VID, LINE, EXT1, EXT2, and RFB triggers.
Initial S/W Revision	Prior to A.02.00

Periodic Timer (Frame Trigger)

Pressing this key, when it is not selected, selects the internal periodic timer signal as the trigger. Triggering occurrences are set by the **Period** parameter, which is modified by the **Sync Source** and **Offset**. Pressing this key, when it is already selected, accesses the periodic timer trigger setup functions.

If you do not have a sync source selected (it is Off), then the internal timer will not be synchronized with any external timing events.

Key Path	Trigger
Example	TRIG:SOUR FRAM Swept SA measurement TRIG:<meas>:SOUR FRAM Measurements other than Swept SA

State Saved	Saved in instrument state
Readback	[Sync: <value of Sync Source>], for example, [Sync: External 1]
Status Bits/OPC dependencies	The Status Operation Register bit 5 "Waiting for Trigger" is set at the same time as the Sweeping or Measuring bit is set. It is cleared when the trigger actually occurs (that is, after the trigger event occurs and all the applicable trigger criteria have been met). A corresponding pop-up message ("Waiting for trigger") is generated if no trigger signal appears after approximately 2 sec. This message goes away when a trigger signal appears.
Initial S/W Revision	Prior to A.02.00

Periodic Timer Triggering:

This feature selects the internal periodic timer signal as the trigger. Trigger occurrences are set by the **Periodic Timer** parameter, which is modified by the **Sync Source** and **Offset**.

The figure below shows the action of the periodic timer trigger. Before reviewing the figure, we'll explain some uses for the periodic trigger.

A common application is measuring periodic burst RF signals for which a trigger signal is not easily available. For example, we might be measuring a TDMA radio which bursts every 20 ms. Let's assume that the 20 ms period is very consistent. Let's also assume that we do not have an external trigger source available that is synchronized with the period, and that the signal-to-noise ratio of the signal is not high enough to provide a clean RF burst trigger at all of the analysis frequencies. For example, we might want to measure spurious transmissions at an offset from the carrier that is larger than the bandwidth of the RF burst trigger. In this application, we can set the Periodic Timer to a 20.00 ms period and adjust the offset from that timer to position our trigger just where we want it. If we find that the 20.00 ms is not exactly right, we can adjust the period slightly to minimize the drift between the period timer and the signal to be measured.

A second way to use this feature would be to use **Sync Source** temporarily, instead of **Offset**. In this case, we might tune to the signal in a narrow span and use the RF Burst trigger to synchronize the periodic timer. Then we would turn the sync source off so that it would not miss-trigger. Miss-triggering can occur when we are tuned so far away from the RF burst trigger that it is no longer reliable.

A third example would be to synchronize to a signal that has a reference time element of much longer period than the period of interest. In some CDMA applications, it is useful to look at signals with a short periodicity, by synchronizing that periodicity to the "even-second clock" edge that happens every two seconds. Thus, we could connect the even-second clock trigger to Ext1 and use then Ext1 as the sync source for the periodic timer.

The figure below illustrates this third example. The top trace represents the even-second clock. It causes the periodic timer to synchronize with the leading edge shown. The analyzer trigger occurs at a time delayed by the accumulated offset from the period trigger event. The periodic timer continues to run, and triggers continue to occur, with a periodicity determined by the analyzer time base. The timer output (labeled "late event") will drift away from its ideal time due to imperfect matching between the time base of the signal being measured and the time base of the analyzer, and also because of imperfect setting of the period parameter. But the synchronization is restored on the next even-second clock event. ("Accumulated offset" is described in the in the **Offset** function section.)

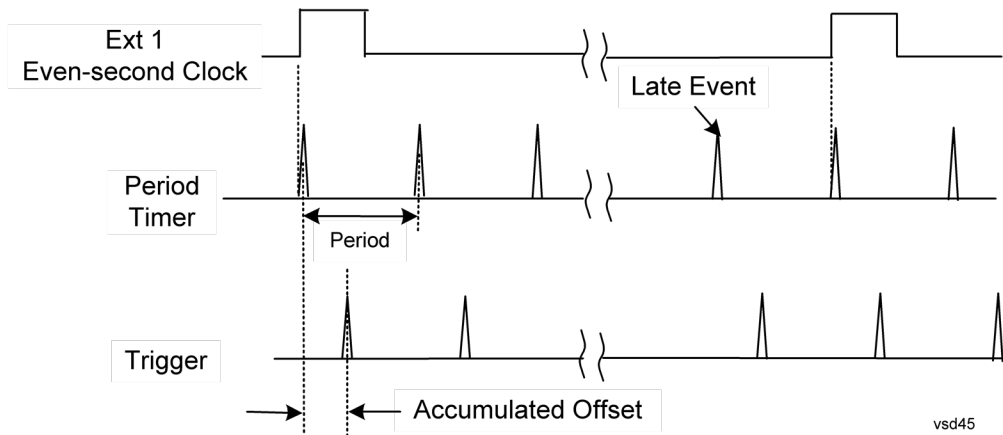

Period

Sets the period of the internal periodic timer clock. For digital communications signals, this is usually set to the frame period of your current input signal. In the case that sync source is not set to OFF, and the external sync source rate is changed for some reason, the periodic timer is synchronized at the every external synchronization pulse by resetting the internal state of the timer circuit.

Key Path	Trigger, Periodic Timer
Remote Command	:TRIGger[:SEquence]:FRAMe:PERiod <time> :TRIGger[:SEquence]:FRAMe:PERiod?
Example	TRIG:FRAM:PER 100 ms
Dependencies	The invalid data indicator turns on when the period is changed, until the next sweep/measurement completes.
Couplings	The same period is used in the Gate Source selection of the period timer.
Preset	20 ms GSM: 4.615383
State Saved	Saved in instrument state
Min	100.000 ns
Max	559.0000 ms
Default Unit	S
Initial S/W Revision	Prior to A.02.00

Offset

Adjusts the accumulated offset between the periodic timer events and the trigger event. Adjusting the accumulated offset is different than setting an offset, and requires explanation.

The periodic timer is usually not synchronized with any external events, so the timing of its output events has no absolute meaning. Since the timing relative to external events (RF signals) is important, you need to be able to adjust (offset) it. However, you have no direct way to see when the periodic timer events occur. All that you can see is the trigger timing. When you want to adjust the trigger timing, you will be changing the internal offset between the periodic timer events and the trigger event. Because the absolute value of

that internal offset is unknown, we will just call that the accumulated offset. Whenever the Offset parameter is changed, you are changing that accumulated offset. You can reset the displayed offset using Reset Offset Display. Changing the display does not change the value of the accumulated offset, and you can still make additional changes to accumulated offset.

To avoid ambiguity, we define that an increase in the "offset" parameter, either from the knob or the SCPI adjust command, serves to delay the timing of the trigger event.

Key Path	Trigger, Periodic Timer
Remote Command	:TRIGger[:SEquence]:FRAMe:OFFSet <time> :TRIGger[:SEquence]:FRAMe:OFFSet?
Example	TRIG:FRAM:OFFS 1.2 ms
Notes	The front panel interface (for example, the knob), and this command, adjust the accumulated offset, which is shown on the active function display. However, the actual amount sent to the hardware each time the offset is updated is the delta value, that is, the current accumulated offset value minus the previous accumulated offset value. Note that the accumulated offset value is essentially arbitrary; it represents the accumulated offset from the last time the offset was zeroed (with the Reset Offset Display key). Note that this command does not change the period of the trigger waveform. Note also that Offset is used only when the sync source is set to OFF, otherwise delay is used, see section " Trig Delay " on page 280 . An increase in the "offset" parameter, either from the knob or the SCPI adjust command, serves to delay the timing of the trigger event.
Notes	When the SCPI command is sent the value shown on the key (and the Active Function, if this happens to be the active function) is updated with the new value. However, the actual amount sent to the hardware is the delta value, that is, the current accumulated offset value minus the previous accumulated offset value. The SCPI query simply returns the value currently showing on the key.
Dependencies	The invalid data indicator turns on when the offset is changed, until the next sweep/measurement completes.
Couplings	The same offset is used in the Gate Source selection of the period timer.
Preset	0 s
State Saved	Saved in instrument state
Min	-10.000 s
Max	10.000 s
Default Unit	S
Initial S/W Revision	Prior to A.02.00

Offset Adjust (Remote Command Only)

This remote command does not work at all like the related front panel keys. This command lets you advance the phase of the frame trigger by the amount you specify.

It does not change the period of the trigger waveform. If the command is sent multiple times, it advances the phase of the frame trigger an additional amount each time it is sent. Negative numbers are permitted.

Remote Command	:TRIGger[:SEquence]:FRAMe:ADJust <time>
Example	TRIG:FRAM:ADJ 1.2 ms
Notes	Note also that Offset is used only when the sync source is set to OFF, otherwise delay is used, see section "Trig Delay" on page 280 An increase in the "offset" parameter, either from the knob or the SCPI adjust command, serves to delay the timing of the trigger event.
Notes	The front panel interface (for example, the knob) and the :TRIG:FRAM:OFFS command adjust the accumulated offset, which is shown on the active function display. However, the actual amount sent to the hardware is the delta value, that is, the current offset value minus the previous offset value. When the SCPI command is sent the value shown on the key (and the Active Function, if this happens to be the active function) is updated by increasing it (or decreasing it if the value sent is negative) by the amount specified in the SCPI command. This is a "command only" SCPI command, with no query.
Dependencies	The invalid data indicator turns on when the offset is changed, until the next sweep/measurement completes.
Couplings	The same offset is used in the Gate Source selection of the period timer.
Preset	0 s
State Saved	Saved in instrument state
Min	-10.000 s
Max	10.000 s
Default Unit	S
Initial S/W Revision	Prior to A.02.00

Reset Offset Display

Resets the value of the periodic trigger offset display setting to 0.0 seconds. The current displayed trigger location may include an offset value defined with the Offset key. Pressing this key redefines the currently displayed trigger location as the new trigger point that is 0.0 s offset. The Offset key can then be used to add offset relative to this new timing.

Key Path	Trigger, Periodic Timer
Remote Command	:TRIGger[:SEquence]:FRAMe:OFFSet:DISPlay:RESet
Example	TRIG:FRAM:OFFS:DISP:RES
Initial S/W Revision	Prior to A.02.00

Sync Source

Selects a signal source for you to synchronize your periodic timer trigger to, otherwise you are triggering at some arbitrary location in the frame. Synchronization reduces the precision requirements on the setting of the period.

For convenience you may adjust the level and slope of the selected sync source in a conditional branch setup menu accessed from the Sync Source menu. Note that these settings match those in the **Trigger** and **Gate Source** menus; that is, each trigger source has only one value of level and slope, regardless of which menu it is accessed from.

Key Path	Trigger, Periodic Timer
Remote Command	:TRIGger[:SEquence]:FRAMe:SYNC EXTernal1 EXTernal2 RFBurst OFF :TRIGger[:SEquence]:FRAMe:SYNC?
Example	TRIG:FRAM:SYNC EXT2
Dependencies	In some models, there is no second External input. In these models, the External 2 key is blanked and the EXTERNAL2 parameter will generate a “Hardware missing; Not available for this model number” message.
Preset	Off GSM/EDGE, MSR,LTE,LTETDD: RFBurst
State Saved	Saved in instrument state
Readback	The current setting is read back to this key and it is also Readback to the previous Periodic Timer trigger key.
Backwards Compatibility SCPI	:TRIGger[:SEquence]:FRAMe:SYNC EXTernal For backward compatibility, the parameter EXTernal is mapped to EXTernal1
Initial S/W Revision	Prior to A.02.00
Modified at S/W Revision	A.03.00, A.14.00

Off

Turns off the sync source for your periodic trigger. With the sync source off, the timing will drift unless the signal source frequency is locked to the analyzer frequency reference.

Key Path	Trigger, Periodic Timer, Sync Source
Example	TRIG:FRAM:SYNC OFF
Readback	Off
Initial S/W Revision	Prior to A.02.00

External 1

Pressing this key, when it is not selected, selects an external input signal as the trigger. A new sweep/measurement will start when the external trigger condition is met using the external 1 input connector on the rear panel.

Pressing this key, when it is already selected, accesses the external 1 trigger setup menu.

Key Path	Trigger
Example	TRIG:SOUR EXT1 Swept SA measurement

	TRIG:<meas>:SOUR EXT1 Measurements other than Swept SA
Dependencies	Grayed out if in use by Point Trigger in the Source Setup menu. Forced to Free Run if already selected and Point Trigger is set to External 1.
State Saved	Saved in instrument state
Status Bits/OPC dependencies	The Status Operation Register bit 5 "Waiting for Trigger" is set at the same time as the Sweeping or Measuring bit is set. It is cleared when the trigger actually occurs (that is, after the trigger event occurs and all the applicable trigger criteria have been met). A corresponding pop-up message ("Waiting for trigger") is generated if no trigger signal appears after approximately 2 sec. This message goes away when a trigger signal appears.
Initial S/W Revision	Prior to A.02.00

Trigger Level

Sets the value where the external 1 trigger input will trigger a new sweep/measurement.

Key Path	Trigger, External 1
Remote Command	:TRIGger[:SEquence]:EXTernal1:LEVel <level> :TRIGger[:SEquence]:EXTernal1:LEVel?
Example	TRIG:EXT1:LEV 0.4 V
Couplings	This same level is used for the Ext1 trigger source in the Trigger menu, for the Ext1 selection in the Periodic Timer sync source (in the Trigger menu and in the Gate Source menu), and also for the Ext1 selection in the Gate Source menu.
Preset	1.2 V
State Saved	Saved in instrument state
Min	-3.5V
Max	3.5V
Default Unit	V
Backwards Compatibility SCPI	:TRIGger[:SEquence]:EXTernal:LEVel For backward compatibility, the parameter EXTernal is mapped to EXTernal1
Backwards Compatibility SCPI	:TRIGger[:SEquence]:FRAME:EXTernal1:LEVel
Initial S/W Revision	Prior to A.02.00

Trig Slope

Controls the trigger polarity. It is set positive to trigger on a rising edge and negative to trigger on a falling edge.

Key Path	Trigger, External 1
Remote Command	:TRIGger[:SEquence]:EXTernal1:SLOPe POSitive NEGative :TRIGger[:SEquence]:EXTernal1:SLOPe?
Example	TRIG:EXT1:SLOP NEG
Couplings	This same slope is used in the Ext1 selection for the trigger source in the Trigger menu and for the period timer sync source (in the Trigger menu and in the Gate Source menu).
Preset	POSitive
State Saved	Saved in instrument state
Backwards Compatibility SCPI	:TRIGger[:SEquence]:EXTernal:SLOPe For backward compatibility, the parameter EXTernal is mapped to EXTernal1
Backwards Compatibility SCPI	:TRIGger[:SEquence]:FRAMe:EXTernal1:SLOPe
Backwards Compatibility Notes	The legacy :TRIGger[:SEquence]:SLOPe command affects the slopes for the VID, LINE, EXT1, EXT2, and RFB triggers.
Initial S/W Revision	Prior to A.02.00

External 2

Pressing this key, when it is not selected, selects an external input signal as the trigger. A new sweep/measurement will start when the external trigger condition is met using the external 2 input connector. The external trigger 2 input connector is on the rear panel.

Pressing this key, when it is already selected, accesses the external 2 trigger setup menu.

Key Path	Trigger
Example	TRIG:SOUR EXT2 Swept SA measurement TRIG:<meas>:SOUR EXT2 Measurements other than Swept SA
Dependencies	In some models, there is no second External input. In these models, the External 2 key is blanked and the EXTernal2 parameter will generate a "Hardware missing; Not available for this model number" message. Grayed out if in use by Point Trigger in the Source Setup menu. Forced to Free Run if already selected and Point Trigger is set to External 2.
State Saved	Saved in instrument state
Status Bits/OPC dependencies	The Status Operation Register bit 5 "Waiting for Trigger" is set at the same time as the Sweeping or Measuring bit is set. It is cleared when the trigger actually occurs (that is, after the trigger event occurs and all the applicable trigger criteria have been met). A corresponding pop-up message ("Waiting for trigger") is generated if no trigger signal appears after approximately 2 sec. This message goes away when a trigger signal appears.
Initial S/W Revision	Prior to A.02.00
Modified at S/W Revision	A.03.00

Trigger Level

Sets the value where the external 2 trigger input will trigger a new sweep/measurement.

Key Path	Trigger, External 2
Remote Command	:TRIGger[:SEquence]:EXTernal2:LEVel :TRIGger[:SEquence]:EXTernal2:LEVel?
Example	TRIG:EXT2:LEV 1.1 V
Couplings	This same level is used for the Ext2 trigger source in the Trigger menu, for the Ext2 selection in the Periodic Timer sync source (in the Trigger menu and in the Gate Source menu), and also for the Ext2 selection in the Gate Source menu.
Preset	1.2 V
State Saved	Saved in instrument state
Min	-3.5V
Max	3.5V
Default Unit	V
Backwards Compatibility SCPI	:TRIGger[:SEquence]:FRAMe:EXTernal2:LEVel
Initial S/W Revision	Prior to A.02.00

Trig Slope

Controls the trigger polarity. It is set positive to trigger on a rising edge and negative to trigger on a falling edge.

Key Path	Trigger, External 2
Remote Command	:TRIGger[:SEquence]:EXTernal2:SLOPe POSitive NEGative :TRIGger[:SEquence]:EXTernal2:SLOPe?
Example	TRIG:EXT2:SLOP NEG
Couplings	This same slope is used in the Ext2 selection for the trigger source in the Trigger menu and for the period timer sync source (in the Trigger menu and in the Gate Source menu).
Preset	POSitive
State Saved	Saved in instrument state
Backwards Compatibility SCPI	:TRIGger[:SEquence]:FRAMe:EXTernal2:SLOPe
Backwards Compatibility Notes	The legacy :TRIGger[:SEquence]:SLOPe command affects the slopes for the VID, LINE, EXT1, EXT2, and RFB triggers.
Initial S/W Revision	Prior to A.02.00

RF Burst

Pressing this key, when it is not selected, selects the RF Burst as the trigger. A new sweep/measurement will start when an RF burst envelope signal is identified from the signal at the RF Input connector. Pressing this key, when it is already selected, accesses the RF Burst trigger setup menu.

In some models, a variety of burst trigger circuitry is available, resulting in various available burst trigger bandwidths. The analyzer automatically chooses the appropriate trigger path based on the hardware configuration and other settings of the analyzer.

Key Path	Trigger
Example	TRIG:SOUR RFB Swept SA measurement TRIG:<meas>:SOUR RFB Measurements other than Swept SA
State Saved	Saved in instrument state
Status Bits/OPC dependencies	The Status Operation Register bit 5 "Waiting for Trigger" is set at the same time as the Sweeping or Measuring bit is set. It is cleared when the trigger actually occurs (that is, after the trigger event occurs and all the applicable trigger criteria have been met). A corresponding pop-up message ("Waiting for trigger") is generated if no trigger signal appears after approximately 2 sec. This message goes away when a trigger signal appears.
Backwards Compatibility Notes	The legacy command: :TRIGger[:SEQuence]:RFBurst:FSElectivity[:STATe] OFF ON 0 1 is not supported in the X-Series, as the hardware to do Frequency Selective burst triggers does not exist in X-Series.
Initial S/W Revision	Prior to A.02.00
Modified at S/W Revision	A.04.00

Absolute Trigger Level

Sets the absolute trigger level for the RF burst envelope.

When using the External Mixing path, the Absolute Trigger Level is uncalibrated because the factory default was set to accommodate the expected IF levels for the RF path.

Key Path	Trigger, RF Burst
Scope	Meas Global
Remote Command	:TRIGger[:SEQuence]:RFBurst:LEVel:ABSolute <ampl> :TRIGger[:SEQuence]:RFBurst:LEVel:ABSolute?
Example	TRIG:RFB:LEV:ABS 10 dBm sets the trigger level of the RF burst envelope signal to the absolute level of 10 dBm
Notes	Sending this command does not switch the setting from relative to absolute; to switch it you need to send the :TRIGger[:SEQuence]:RFBurst:LEVel:TYPE command, below. Amplitude Corrections are not taken into account by the Absolute Trigger Level. For example, if you have given yourself effective gain with an amplitude correction factor, the Absolute Trigger will not fire until you have set the trigger level that far below the displayed signal level, rather than simply to

	the displayed signal level. This is only true for Amplitude Corrections, not External Gain or Ref Level Offset functions. If mode is Bluetooth, the default value is -50 dBm.
Couplings	This same level is used for the RF Burst trigger source in the Trigger menu, for the RF Burst selection in the Periodic Timer sync source (in the Trigger menu and in the Gate Source menu), and also for the RF Burst selection in the Gate Source menu
Preset	-20 dBm
State Saved	Saved in instrument state
Min	-200 dBm
Max	100 dBm
Default Unit	depends on the current selected Y-Axis unit
Backwards Compatibility SCPI	:TRIGger[:SEquence]:FRAMe:RFBurst:LEVel:ABSolute
Initial S/W Revision	Prior to A.02.00
Modified at S/W Revision	A.04.00

Key Path	Trigger, RF Burst
Remote Command	:TRIGger[:SEquence]:RFBurst:LEVel:TYPE ABSolute RELative :TRIGger[:SEquence]:RFBurst:LEVel:TYPE?
Example	TRIG:RFB:LEV:TYPE REL sets the trigger level type of the RF burst trigger to Relative.
Preset	ABSolute
State Saved	Saved in instrument state
Initial S/W Revision	Prior to A.02.00
Modified at S/W Revision	A.04.00

Trigger Slope

It is set positive to trigger on a rising edge and negative to trigger on a falling edge.

Key Path	Trigger, RF Burst
Remote Command	:TRIGger[:SEquence]:RFBurst:SLOPe POSitive NEGative :TRIGger[:SEquence]:RFBurst:SLOPe?
Example	TRIG:RFB:SLOP NEG
Couplings	This same slope is used in the RF Burst selection for the trigger source in the Trigger menu and for the period timer sync source (in the Trigger menu and in the Gate Source menu).
Preset	POSitive
State Saved	Saved in instrument state

Backwards Compatibility SCPI	:TRIGger[:SEQuence]:FRAMe:RFBurst:SLOPe
Backwards Compatibility Notes	The legacy :TRIGger[:SEQuence]:SLOPe command affects the slopes for the VID, LINE, EXT1, EXT2, and RFB triggers.
Initial S/W Revision	Prior to A.02.00

Sync Holdoff

Sync Holdoff specifies the duration that the sync source signal must be kept false before the transition to true to be recognized as the sync timing. The periodic timer phase is aligned when the sync source signal becomes true, after the Holdoff time is satisfied.

A holdoff of 2 ms will work with most WiMAX signals, but there may be cases where the burst off duration is less than 1 ms and this value will need to be changed.

Key Path	Trigger, Periodic Timer
Remote Command	:TRIGger[:SEQuence]:FRAMe:SYNC:HOLDoff <time> :TRIGger[:SEQuence]:FRAMe:SYNC:HOLDoff? :TRIGger[:SEQuence]:FRAMe:SYNC:HOLDoff:STATE OFF ON 0 1 :TRIGger[:SEQuence]:FRAMe:SYNC:HOLDoff:STATE?
Preset	On, 1.000 ms
State Saved	Saved in instrument state
Min	0 ms
Max	+500 ms
Default Unit	s
Initial S/W Revision	Prior to A.02.00

Auto/Holdoff

Opens up a menu that lets you adjust Auto Trigger and Trigger Holdoff parameters

Key Path	Trigger
Readback line	Displays a summary of the Auto Trig and Holdoff settings, in square brackets First line: Auto Off or Auto On Second Line: "Hldf" followed by: <ul style="list-style-type: none"> • If Holdoff is Off, readback Off • If Holdoff On and Type = Normal, readback value • If Holdoff On and Type = Above, readback value followed by AL • If Holdoff On and Type = Below, readback value followed by BL • If Holdoff Type selection is not supported by the current measurement, Holdoff Type is always Normal
Initial S/W Revision	A.02.00

Auto Trig

Sets the time that the analyzer will wait for the trigger conditions to be met. If they are not met after that much time, then the analyzer is triggered anyway.

Key Path	Trigger, Auto/Holdoff
Remote Command	:TRIGger[:SEquence]:ATRigger <time> :TRIGger[:SEquence]:ATRigger? :TRIGger[:SEquence]:ATRigger:STATe OFF ON 0 1 :TRIGger[:SEquence]:ATRigger:STATe?
Example	TRIG:ATR:STAT ON TRIG:ATR 100 ms
Notes	The "time that the analyzer will wait" starts when the analyzer is ready for a trigger, which may be hundreds of ms after the data acquisition for a sweep is done. The "time" ends when the trigger condition is satisfied, not when the delay ends.
Preset	Off, 100 ms
State Saved	Saved in instrument state
Min	1 ms
Max	100 s
Default Unit	s
Initial S/W Revision	Prior to A.02.00

Trig Holdoff

Sets the holdoff time between triggers. When the trigger condition is satisfied, the trigger occurs, the delay begins, and the holdoff time begins. New trigger conditions will be ignored until the holdoff time expires. For a free-running trigger, the holdoff value is the minimum time between triggers.

Key Path	Trigger, Auto/Holdoff
Remote Command	:TRIGger[:SEquence]:HOLDoFF <time> :TRIGger[:SEquence]:HOLDoFF? :TRIGger[:SEquence]:HOLDoFF:STATe OFF ON 0 1 :TRIGger[:SEquence]:HOLDoFF:STATe?
Example	TRIG:HOLD:STAT ON TRIG:HOLD 100 ms
Dependencies	Unavailable if the selected Input is BBIQ. If this is the case, the key is grayed out if it is pressed the informational message "Feature not supported for this Input" is displayed. If the SCPI command is sent, the error "Settings conflict; Feature not supported for this Input" is generated.
Preset	Off, 100 ms
State Saved	Saved in instrument state
Min	0 s

Max	0.5 s
Default Unit	s
Initial S/W Revision	Prior to A.02.00

Gate Preset (Remote Command Only)

Presets the time-gated spectrum analysis capability.

This command sets gate parameter values to the ESA preset values, as follows:

Gate delay = 1 us

Gate length = 1 us

Remote Command	<code>[[:SENSe]:SWEep:TIME:GATE:PRESet ESA Compatibility</code>
Initial S/W Revision	Prior to A.02.00

Gate Level (Remote Command Only)

Sets the gate input transition point level for the external TRIGGER inputs on the front and rear panel. This is a legacy command for PSA compatibility. It is simply an alias to the equivalent trigger level command.

Remote Command	<code>[[:SENSe]:SWEep:EGATe:EXTeRnal[1] 2:LEVel <voltage></code> <code>[[:SENSe]:SWEep:EGATe:EXTeRnal[1] 2:LEVel?</code>
Notes	This command is simply an alias to <code>:TRIGger[:SEQuence]:EXTeRnal[1]2:LEVel</code> For details refer
Initial S/W Revision	Prior to A.02.00

Gate Polarity (Remote Command Only)

Sets the polarity for the gate signal. This setup is now done using the gate trigger's slope setting.

When Positive (Pos) is selected, a positive-going edge (Edge) or a high voltage (Level) will satisfy the gate condition, after the delay set with the Gate Delay key. When Negative (Neg) is selected, a negative-going edge (Edge) or a low voltage (Level) will satisfy the gate condition after the delay.

Remote Command	<code>[[:SENSe]:SWEep:EGATe:POLarity NEGative POSitive</code> <code>[[:SENSe]:SWEep:EGATe:POLarity?</code>
Example	<code>SWE:EGAT:POL NEG</code> <code>SWE:EGAT:POL?</code>
Preset	POSitive

State Saved	Saved in instrument state
Backwards Compatibility SCPI	[:SENSe]:SWEep:TIME:GATE:POLarity ESA compatibility
Initial S/W Revision	Prior to A.02.00

Remote Command	[:SENSe]:SWEep:TIME:GATE:LEVel HIGH LOW [:SENSe]:SWEep:TIME:GATE:LEVel? ESA compatibility
Preset	HIGH
Initial S/W Revision	Prior to A.02.00

Points

Sets the number of points per sweep. The resolution of setting the sweep time depends on the number of points selected. The current value of points is displayed parenthetically, next to the sweep time in the lower-right corner of the display.

Key Path	Sweep/Control
Mode	SA, WCDMA, C2K, WIMAX OFDMA, TD-SCDMA, 1xEVDO, ISDB-T, CMMB, LTE, LTETDD, BLUETOOTH, WLAN, MSR, LTEAFDD, LTEATDD
Remote Command	[:SENSe]:OBwidth:SWEep:POINts <integer> [:SENSe]:OBwidth:SWEep:POINts?
Example	OBW:SWE:POIN 1500 OBW:SWE:POIN?
Notes	This function is not available when signal identification is set to On (external mixing). Affected by: log sweep Grayed out in measurements that don't support swept Blanked in modes that do not support swept. Whenever the number of sweep points change: - All trace data is erased - Any traces with Update Off also go to Display Off (like going from View to Blank in the older analyzers) - Sweep time is re-quantized - Any limit lines that are on are updated - If averaging/hold is on, averaging/hold starts over
Couplings	Whenever the number of sweep points change, the sweep time is re-quantized.
Preset	LTE, LTETDD, MSR, LTEAFDD, LTEATDD: 2001 Other: 1001

11 Occupied Bandwidth Measurement
Sweep/Control

State Saved	Saved in instrument state.
Min	101
Max	20001
Initial S/W Revision	Prior to A.02.00
Modified at S/W Revision	A.03.00

System

See "System" on page 189

Trace/Detector

Accesses a menu of functions that enable you to control the detectors for the current measurement.

Key Path	Front-panel key
Initial S/W Revision	Prior to A.02.00

Trace Type

Allows you to select the type of trace you want to use for the current measurement.

The first page of this menu contains a 1-of-N selection of the trace type (Clear Write, Average, Max Hold, Min Hold) for the selected trace.

Key Path	Trace/Detector
Mode	SA, WCDMA, C2K, WIMAX OFDMA, TD-SCDMA, 1xEVDO, ISDB-T, CMMB, LTE, LTETDD, BLUETOOTH, WLAN, MSR, LTEAFDD, LTEATDD
Remote Command	:TRACe:OBWidth:TYPE WRITe AVERAge MAXHold MINHold :TRACe:OBWidth:TYPE?
Example	TRAC:OBW:TYPE MINH TRAC:OBW:TYPE?
Notes	WRITe = Clear Write AVERAge = Average MAXHold = Maximum Hold MINHold = Minimum Hold
Couplings	When Detector setting is "Auto" (:SENSe]:OBWidth:DETEctor:AUTO?), Detector (:SENSe]:OBWidth:DETEctor:FUNCTioN]?) switches aligning with the switch of this parameter: "NORMal" with WRITe (Clear Write), "AVERAge" with AVERAge, "POSitive (peak)" with MAXHold, and "NEGative (peak)" with MINHold.
Preset	AVERAge BLUETOOTH: MAX HOLD.
State Saved	Saved in instrument state.
Range	WRITe AVERAge MAXHold MINHold
Initial S/W Revision	Prior to A.02.00
Modified at S/W Revision	A.03.00

Detector

Accesses a menu of functions that enables you to control the detectors for the current measurement. The following choices are available:

- **Auto**– the detector selected depends on marker functions, trace functions, average type, and the trace averaging function.

- **Normal**–the detector determines the peak of the CW-like signals, and it yields alternating maximums and minimums of noise-like signals. This is also referred to as Rosenfell detection.
- **Average**–the detector determines the average of the signal within the sweep points. The averaging method depends upon the Average Type selection (voltage, power or log scales).
- **Peak (Positive)**–the detector determines the maximum of the signal within the sweep points.
- **Sample**–the detector indicates the instantaneous level of the signal at the center of the sweep points represented by each display point.
- **Negative Peak**–the detector determines the minimum of the signal within the sweep points.

Key Path	Detector
Initial S/W Revision	Prior to A.02.00

Auto

When the detector choice is Auto, the analyzer selects the detector. The selected detector depends on marker functions, trace functions, and trace averaging functions for the current measurement.

Key Path	Trace/Detector
Remote Command	<code>[[:SENSe]:OBWidth:DETECTOR:AUTO ON OFF 1 0</code> <code>[[:SENSe]:OBWidth:DETECTOR:AUTO?</code>
Example	OBW:DET:AUTO ON OBW:DET:AUTO?
Couplings	When Detector setting is “Auto” (<code>[[:SENSe]:OBWidth:DETECTOR:AUTO?</code>), Detector (<code>[[:SENSe]:OBWidth:DETECTOR:[FUNCTION]?</code>) switches aligning with the switch of this parameter: “NORMal” with Clear Write, “AVERage” with AVERage, “POSitive (peak)” with MAXHold, and “NEGative (peak)” with MINHold.
Preset	ON ISDB-T: OFF
State Saved	Saved in instrument state.
Initial S/W Revision	Prior to A.02.00
Modified at S/W Revision	A.03.00

Detector Selection

Allows you to select a specific detector for the current measurement. When the detector choice is Auto, the analyzer selects the detector. The selected detector depends on marker functions, trace functions, and trace averaging functions for the current measurement.

Key Path	Trace/Detector
Mode	SA, WCDMA, C2K, WIMAX OFDMA, TD-SCDMA, 1xEVDO, ISDB-T, CMMB, LTE, LTE4DD, BLUETOOTH, WLAN, MSR, LTEAFDD, LTEATDD

Remote Command	<code>[[:SENSe]:OBWidth:DETEctor[:FUNction] NORMal AVERage POSitive SAMPlE NEGative [:SENSe]:OBWidth:DETEctor[:FUNction]?</code>
Example	<code>OBW:DET NORM OBW:DET?</code>
Notes	<p>When you manually select a detector (instead of selecting Auto), that detector is used regardless of other analyzer settings.</p> <p>The detector choices are:</p> <p>The Normal detector determines the peak of CW-like signals, and it yields alternating maximums and minimums of noise-like signals. This is also referred to as Rosenfell detection.</p> <p>The Average detector determines the average of the signal within the sweep points. The averaging method is Power Average (RMS).</p> <p>The Peak detector determines the maximum of the signal within the sweep points.</p> <p>The Sample detector indicates the instantaneous level of the signal at the center of the sweep points represented by each display point.</p> <p>The Negative Peak detector determines the minimum of the signal within the sweep points.</p>
Couplings	When Detector setting is "Auto" (<code>[[:SENSe]:OBWidth:DETEctor:AUTO?</code>), Detector (<code>[[:SENSe]:OBWidth:DETEctor[:FUNction]?</code>) switches aligning with the switch of this parameter: "NORMal" with Clear Write, "AVERage" with AVERage, "POSitive (peak)" with MAXHold, and "NEGative (peak)" with MINHold.
Preset	AVERage ISDB-T: Peak BLUETOOTH: Peak
State Saved	Saved in instrument state.
Range	Normal Average Peak Sample Negative Peak
Initial S/W Revision	Prior to A.02.00
Modified at S/W Revision	A.03.00

Trigger

See ["Trigger" on page 248](#)

Free Run

See ["Free Run " on page 255](#)

Video

See ["Video \(IF Envelope\) " on page 1440](#)

Trigger Level

See ["Trigger Level " on page 1440](#)

Trig Slope

See ["Trig Slope " on page 1441](#)

Trig Delay

See ["Trig Delay " on page 258](#)

External 1

See ["External 1 " on page 1454](#)

Trigger Level

See ["Trigger Level " on page 1455](#)

Trig Slope

See ["Trig Slope " on page 1455](#)

Trig Delay

See ["Trig Delay " on page 261](#)

Zero Span Delay Comp

See ["Zero Span Delay Comp On/Off " on page 1443](#)

External 2

See ["External 2 " on page 1456](#)

Trigger Level

See ["Trigger Level " on page 1457](#)

Trig Slope

See ["Trig Slope " on page 1457](#)

Trig Delay

See "[Trig Delay](#) " on page 264

Zero Span Delay Comp

See "[Zero Span Delay Comp On/Off](#)" on page 1446

RF Burst

See "[RF Burst](#) " on page 1458

Absolute Trigger

See "[Absolute Trigger Level](#)" on page 1458

Relative Trigger

See "[Relative Trigger Level](#)" on page 1448

Trig Slope

See "[Trigger Slope](#) " on page 1459

Trig Delay

See "[Trig Delay](#) " on page 268

Periodic Timer

See "[Periodic Timer \(Frame Trigger\)](#) " on page 1449

Period

See "[Period](#) " on page 1451

Offset

See "[Offset](#) " on page 1451

Reset Offset Display

See "[Reset Offset Display](#) " on page 1453

Sync Source

See "[Sync Source](#) " on page 1453

Off

See "[Off](#) " on page 1454

External 1

See "[External 1](#) " on page 1454

Trigger Level

See "Trigger Level " on page 1455

Trig Slope

See "Trig Slope " on page 1455

External 2

See "External 2 " on page 1456

Trigger Level

See "Trigger Level " on page 1457

Trig Slope

See "Trig Slope " on page 1457

RF Burst

See "RF Burst " on page 1458

Absolute Trigger

See "Absolute Trigger Level" on page 1458

Trig Slope

See "Trigger Slope " on page 1459

Trig Delay

See "Trig Delay" on page 280

Auto/Holdoff

See "Auto/Holdoff " on page 1460

Auto Trig

See "Auto Trig " on page 1461

Trig Holdoff

See "Trig Holdoff " on page 1461

Internal

See "Internal" on page 282

User Preset

Accesses a menu that gives you the following three choices:

- User Preset – recalls a state previously saved using the Save User Preset function.
- User Preset All Modes – presets all of the modes in the analyzer
- Save User Preset– saves the current state for the current mode

NOTE

In products that run multiple instances of the X-Series Application, all instances use the same location to save User Preset state. So Save User Preset of one instance will overwrite the Save User Preset of another instance.

Key Path	Front-panel key
Backwards Compatibility Notes	<p>User Preset is actually loading a state, and in legacy analyzers, it was possible to load a state without affecting the trace data, limit lines or correction data. Similarly it was possible to do a User Preset without affecting the trace data, limit lines or correction data.</p> <p>In the X-Series, “state” always includes all of this data; so whenever state is loaded, or User Preset is executed, all of the traces, limit lines and corrections are affected. Although this differs from previous behavior, it is desirable behavior, and should not cause adverse issues for users.</p> <p>On ESA and PSA, User Preset affected the entire instrument’s state. In the X-Series, User Preset only recalls the state for the active mode. There is a User Preset file for each mode. User Preset can never cause a mode switch as it can in legacy analyzers. If you want to recall all modes to their user preset file state, you will need to do a User Preset after mode switching into each mode.</p> <p>User Preset recalls mode state which can now include data like traces; whereas on ESA and PSA, User Preset did not affect data.</p>
Initial S/W Revision	Prior to A.02.00

User Preset

User Preset sets the state of the currently active mode back to the state that was previously saved for this mode using the Save User Preset menu key or the SCPI command, SYST:PRES:USER:SAV. It not only recalls the Mode Preset settings, but it also recalls all of the mode persistent settings, and the Input/Output system setting that existed at the time Save User Preset was executed.

If a Save User Preset has not been done at any time, User Preset recalls the default user preset file for the currently active mode. The default user preset files are created if, at power-on, a mode detects there is no user preset file. There will never be a scenario when there is no user preset file to restore. For each mode, the default user preset state is the same state that would be saved if a Save User Preset is performed in each mode right after doing a Restore Mode Default and after a Restore Input/Output Defaults.

The User Preset function does the following:

- Aborts the currently running measurement.
- Sets the mode State to the values defined by Save User Preset.
- Makes the saved measurement for the currently running mode the active measurement.
- Brings up the saved menu for the power-on mode.

- Clears the input and output buffers.
- Sets the Status Byte to 0.

Key Path	User Preset
Remote Command	:SYSTem:PRESet:USER
Example	:SYST:PRES:USER:SAVE:SYST:PRES:USER
Notes	:SYST:PRES:USER:SAVE is used to save the current state as the user preset state. Clears all pending OPC bits. The Status Byte is set to 0. Pressing the User Preset front-panel key while already in the User Preset menu will cause the User Preset to get executed
Couplings	A user preset will cause the currently running measurement to be aborted and cause the saved measurement to be active. Recalling a User Preset file has the same issues that recalling a Save State file has. Some settings may need to be limited and therefore re-coupled, since the capabilities of the mode may have changes when the User Preset file was last saved.
Initial S/W Revision	Prior to A.02.00

User Preset All Modes

Recalls all of the User Preset files for each mode, switches to the power-on mode, and activates the saved measurement from the power-on mode User Preset file.

NOTE

When the instrument is secured, all of the user preset files are converted back to their default user preset files.

The User Preset function does the following:

- Aborts the currently running measurement.
- Switches the Mode to the power-on mode.
- Restores the User Preset files for each mode.
- Makes the saved measurement for the power-on mode the active measurement.
- Brings up the saved menu for the power-on mode.
- Clears the input and output buffers.
- Sets the Status Byte to 0.

Key Path	User Preset
Remote Command	:SYSTem:PRESet:USER:ALL
Example	:SYST:PRES:USER:SAVE:SYST:PRES:USER:ALL
Notes	Clears all pending OPC bits. The Status Byte is set to 0. :SYST:PRES:USER:SAVE is used to save the current state as the user preset state.
Couplings	A user preset will cause the currently running measurement to be aborted, cause a mode switch to the power-on mode, and cause the saved measurement to be active in the power-on mode.

Recalling a User Preset file has the same issues that recalling a Save State file has. Some settings may need to be limited and therefore re-coupled, since the capabilities of the mode may have changes when the User Preset file was last saved.

Initial S/W Revision Prior to A.02.00

Save User Preset

Saves the currently active mode and its State. You can recall this User Preset file by pressing the User Preset menu key or sending the SYST:PRES:USER remote command. This same state is also saved by the Save State function.

Key Path User Preset

Remote Command :SYSTem:PRESet:USER:SAVE

Example :SYST:PRES:USER:SAVE

Notes :SYST:PRES:SAVE creates the same file as if the user requested a *SAV or a MMEM:STOR:STAT, except User Preset Save does not allow the user to specify the filename or the location of the file.

Initial S/W Revision Prior to A.02.00

12 Code Domain Measurement

The code domain measurement displays the power for each of the de-spread channels, relative to the total power within the 1.230 MHz channel bandwidth centered at the center frequency. Each de-spread channel level is displayed as an individual vertical bar with a different width determined by a spread rate. This allows a comparison of signal levels between the Pilot and Traffic channels. For more details, see ["Code Domain Measurement Description" on page 1482](#) below. For measurement results and views, see ["View/Display" on page 1713](#).

This topic contains the following sections:

["Measurement Commands for Code Domain" on page 1476](#)

["Remote Command Results for Code Domain Measurement" on page 1477](#)

Measurement Commands for Code Domain

The general functionality of CONFigure, FETCh, MEASure, and READ are described at the beginning of this section. See the SENSE:CDPower commands for more measurement related commands.

:CONFigure:CDPower

:INITiate:CDPower

:FETCh:CDPower [n] ?

:READ:CDPower [n] ?

:MEASure:CDPower [n] ?

For more measurement related commands, see the SENSE subsystem, and the section "[Remote Measurement Functions](#)" on page 2015

Remote Command Results for Code Domain Measurement

This measures the power levels of the spread channels in RF channel(s). You must be in the CDMA2000 to use these commands. Use INSTRUMENT:SElect to set the mode.

Index: n	Results Returned
0	Returns unprocessed I/Q trace data, as a series of comma-separated trace points, in volts. The I values are listed first in each pair, using the 0 through even-indexed values. The Q values are the odd-indexed values.
not specified or n = 1	<p>Returns the following 19 comma-separated scalar results:</p> <p style="padding-left: 40px;">Result Name: (type of number) [unit] <explanation></p> <ol style="list-style-type: none"> 1. RMS symbol EVM: (floating) [percent] The dispreading (symbol) RMS EVM of the selected code(Walsh code length and code number) over the selected measurement period by Meas Offset and Meas Interval. 2. Peak symbol EVM: (floating) [percent] The dispreading (symbol) peak EVM of the selected code(Walsh code length and code number) over the selected measurement period by Meas Offset and Meas Interval. 3. Symbol magnitude error: (floating) [percent] The RMS-averaged magnitude error of symbol I/Q Polar Vector of the selected code over the selected measurement period by Meas Offset and Meas Interval. 4. Symbol phase error: (floating) [degree] The RMS-averaged Phase error of symbol I/Q Polar Vector of the selected code over the selected measurement period by Meas Offset and Meas Interval. 5. Total Power: (floating) [dBm] The total RF power over the selected measurement period by Meas Offset and Meas Interval. 6. Channel Power: (floating) [dBc or dBm] The absolute or relative (relative to Total Power) power of the selected code over the measurement period selected by Meas Offset and Meas Interval. 7. Total active power: (floating) [dBc or dBm] The sum of the active code channel powers over one PCG specified by Meas Offset. 8. Pilot power: (floating) [dBc or dBm] The average power of the pilot code (absolute or relative to Total Power) over one PCG specified by Meas Offset. 9. Sync power: (floating) [dBc or dBm] The average power of the pilot code (absolute or relative to Total Power) one PCG specified by Meas Offset. In MS mode, the value returned is -999.0. 10. Maximum active traffic power: (floating) [dBc or dBm] The maximum power of active code (absolute or relative to Total Power) over one PCG specified by Meas Offset. If no active codes are detected, the value returned is -999.0. In MS mode, the value returned is -999.0.

11. Average active traffic power: (floating) [dBc or dBm]

The average power of active code (absolute or relative to Total Power) over one PCG specified by Meas Offset.

If no active codes are detected, the value returned is -999.0.

In MS mode, the value returned is -999.0.

12. Maximum inactive traffic power: (floating) [dBc or dBm]

The maximum power of inactive code (absolute or relative to Total Power) over one PCG specified by Meas Offset.

In MS mode, the value returned is -999.0.

13. Average inactive traffic power: (floating) [dBc or dBm]

The average power of inactive code (absolute or relative to Total Power) over one PCG specified by Meas Offset.

In MS mode, the value returned is -999.0.

14. Number of active channels: (integer) [no unit]

The total number of active codes.

In MS mode, the value returned is -999.

15. I channel average active power: (floating) [dBc or dBm]

The average power of the active I channels (absolute or relative to Total Power).

If no active codes are detected, the value returned is -999.0.

In BTS mode, the value returned is -999.0.

16. I channel maximum inactive power: (floating) [dBc or dBm]

The maximum power of the inactive I channels (absolute or relative to Total Power).

In BTS mode, the value returned is -999.0

17. Q channel average active power: (floating) [dBc or dBm]

The average power of the active Q channels (absolute or relative to Total Power).

If no active codes are detected, the value returned is -999.0.

In BTS mode, the value returned is -999.0.

18. Q channel maximum inactive : (floating) [dBc or dBm]

The maximum power of the inactive Q channels (absolute or relative to Total Power).

In BTS mode, the value returned is -999.0

19. Time between trigger to PN offset: (floating) [μ s]

The time from the trigger point to the PN offset.

In the MS mode, the valued returned is -999.0.

2 Code Domain Power:

<CDPower> Returns series of floating point numbers (in dB or dBm depend on the Meas Type) that represent all code domain powers.

In BTS mode, there are 64 or 128 numbers depending on CALCulate:CDPower:WCODE:BASE

1st number = 1st code power over one PCG specified by Meas Offset.

2nd number = 2nd code power over one PCG specified by Meas Offset.

....

Nth number = Nth code power over one PCG specified by Meas Offset

	<p>In MS Mode, there are total 32 IQ pairs. I and Q results are returned alternatively. If the active channel occupies more than max spreading factor, the power is duplicated.</p> <p>1st number = 1st In Phase code power over one PCG specified by Meas Offset.</p> <p>2nd number = 1st Quad Phase code power over one PCG specified by Meas Offset.</p> <p>....</p> <p>(2xN-1)th number = Nth In Phase code power over one PCG specified by Meas Offset.</p> <p>(2xN)th number = Nth Quad Phase code power over one PCG specified by Meas Offset.</p> <p>N = the number of codes detected. The total number of codes varies because of the different symbol rates of each code.</p>
3	<p>Symbol Rate:</p> <p>Returns series of floating point numbers (in symbol rate) that represent all code domain symbol rate. When in BTS Mode, the total is 64 or 128 depending on CALCulate:CDPower:WCODE:BASE.</p> <p>1st number = 1st code symbol rate over one PCG specified by Meas Offset.</p> <p>2nd number = 2nd code symbol rate over one PCG specified by Meas Offset.</p> <p>....</p> <p>Nth number = Nth code symbol rate over one PCG specified by Meas Offset.</p> <p>In MS Mode, I and Q results are returned alternatively. Total IQ pairs are 32. If the active channel occupies more than max spreading factor, the Symbol rate is duplicated</p> <p>1st number = 1st In Phase code symbol rate over one PCG specified by Meas Offset.</p> <p>2nd number = 1st Quad Phase code symbol rate one PCG specified by Meas Offset.</p> <p>....</p> <p>(2xN-1)th number = Nth In Phase code symbol rate over one PCG specified by Meas Offset.</p> <p>(2xN)th number = Nth Quad Phase code symbol rate over one PCG specified by Meas Offset.</p>
4	<p>Active Status:</p> <p>Returns series of floating point numbers that show either active or inactive of each code returned in n=2 and 3. When the code is inactive, the result is 0.0, otherwise more than 0.0</p> <p>In BTS mode, IQ combined results are returned.</p> <p>1st number = Active or inactive flag of the 1st code.</p> <p>....</p> <p>Nth number = Active or inactive flag of the Nth code.</p> <p>In MS mode, I and Q results are returned alternatively.</p> <p>1st number = 1st In Phase code active flag.</p> <p>2nd number = 1st Quad Phase code active flag.</p> <p>....</p> <p>(2xN-1)th number = Nth In Phase code active flag</p> <p>(2xN)th number = Nth Quad Phase code active flag</p>
5	<p>Symbol EVM:</p> <p><EVM> Returns series of floating point numbers (in percent) that represent each sample in the EVM trace. The first number is the symbol 0 decision point. There are X points per symbol (X=points/chip). Therefore, the decision points are at 0, 1*X, 2*X, ...</p>
6	<p>Symbol Magnitude error:</p> <p><MERRor> Returns series of floating point numbers (in percent) that represent each sample in the magnitude error</p>

	<p>trace. The first number is the symbol 0 decision point. There are X points per symbol (X=points/chip). Therefore, the decision points are at 0, 1*X, 2*X, ...</p>
7 <PERRor>	<p>Symbol Phase error: Returns series of floating point numbers (in percent) that represent each sample in the phase error trace. The first number is the symbol 0 decision point. There are X points per symbol (X=points/chip). Therefore, the decision points are at 0, 1*X, 2*X, ...</p>
8	<p>I/Q Corrected Measured Trace: Returns series of floating point numbers that alternately represent I and Q pairs of the corrected measured trace of the selected code channel. The first number is the in-phase(I) sample of symbol 1 decision point and the second is the quadrature-phase(Q) sample of symbol 1 decision point. As in the EVM, there are X points per symbol, so that: 1st number = I of the 1st symbol decision point 2nd number = Q of the 1st symbol decision point ... (2*X)+1 number = I of the 2nd symbol decision point (2*X)+2 number = Q of the 2nd symbol decision point ... (2*X) ×(N-1)+1 number = I of the Nth symbol decision point (2*X) ×(N-1)+2 number = Q of the Nth symbol decision point Where X = the number of points per symbol, and N = the number of symbols. Note: The values of "I" and "Q" in the measured trace are normalized by the maximum value of the magnitude (=SQRT(I*I + Q*Q)) of the reference trace. For QPSK modulation, the magnitude of each I/Q pair is scaled to SQRT(2.0), and for BPSK modulation, it is scaled to SQRT(1.0).</p>
9 <SPOWer>	<p>Symbol Power vs. Time: Returns series of floating point number (in dBm) that represent the trace data of the symbol power vs. time of the selected code channel.</p>
10 <CPOWer>	<p>Chip Power vs. Time: Returns series of floating point numbers (in dBm) that represent the entire trace data of Chip Power vs. Time.</p>
11	<p>Demod Bits: Returns series of floating point numbers of symbol values for the selected code channel for the entire capture length. If a channel's spreading has been done on only I or Q branch, queried data represents the sequence of corresponding I or Q data. If a channel's spreading has been done on both I and Q branch and its modulation scheme is QPSK, queried data represents alternating I and Q sequences as follows: 1st number = in-phase bit of the 1st I/Q pair 2nd number = quad-phase bit of the 1st I/Q pair 3rd number = in-phase bit of the 2nd I/Q pair 4th number = quad-phase bit of the 2nd I/Q pair</p>

$(2 \times N - 1)$ th number = in-phase bit of the Nth I/Q pair
 $(2 \times N)$ th number = quad-phase bit of the Nth I/Q pair
 where N is the number of the symbols in the entire capture length.

12

Code Domain Error:

Returns a series of floating point numbers (in dB or dBm) that represents all the code domain errors.

In BTS mode, there are 64 or 128 numbers depending on Base Code Length.

1st number = 1st code domain error over one PCG specified by Meas Offset

2nd number = 2nd code domain error over one PCG specified by Meas Offset...

N th number = N th code domain error over one PCG specified by Meas Offset

In MS mode, there are 32 I/Q pairs.

1st number = 1st in-phase code domain error over one PCG specified by Meas Offset

2nd number = 1st quad-phase code domain error over one PCG specified by Meas Offset.

...

$(2 \times N - 1)$ number = N th in-phase code domain error over one PCG specified by Meas Offset.

$(2 \times \boxtimes N)$ number = N th quad-phase code domain error over one PCG specified by Meas Offset.

Code Domain Measurement Description

If Device is set as MS, the demodulated I and Q signals are individually shown in the code domain power graph window. Depending on the test equipment for MS, it is recommended that you use the trigger output signal from the instrument for synchronization.

Key Path	Front-panel key
Initial S/W Revision	Prior to A.02.00

AMPTD Y Scale

Accesses a menu of functions that enable you to set the desired vertical scale parameters for the current measurement.

Numbers and default numbers are independent for each window.

Metrics window and I/Q Symbol Polar Vector and Demod Bits window do not have this menu (Blank menu).

Key Path	Front-panel key
Initial S/W Revision	Prior to A.02.00

Range

The Range menu allows setting amplitude controls of the instrument.

Key Path	AMPTD Y Scale
Scope	Meas Global
Initial S/W Revision	A.12.50

Range

Represents the amplitude of the largest sinusoidal signal that could be present within the IF without being clipped by the ADC. For signals with high peak-to-average ratios, the range may need to exceed the rms signal power by a fair amount to avoid clipping.

Key Path	Range
Mode	BASIC
Remote Command	<code>[:SENSe] :POWer [:RF] :RANGe <real></code> <code>[:SENSe] :POWer [:RF] :RANGe?</code>
Example	<code>:POW:RANG 10.0</code> <code>:POW:RANG?</code>
Notes	The MIN and MAX values are affected by the External Gain parameters, and by the Center Frequency. (The hardware compensates for frequency response and alters the Range setting.)
Preset	0
State Saved	Saved in instrument state.
Min	-100
Max	100
Initial S/W Revision	A.12.50

Adjust Range For Min Clip

Sets the combination of attenuation and gain based on the current measured signal level so that clipping will be at a minimum.

This is an "immediate action" function, that is, it executes once, when the key is pressed.

This key is grayed out in measurements that do not support this functionality.

Key Path	AMPTD Y Scale, Attenuation
Remote Command	<code>[:SENSe] :POWer [:RF] :RANGe :OPTimize IMMEDIATE</code>
Initial S/W Revision	Prior to A.02.00
Modified at S/W Revision	A.03.00

Pre-Adjust for Min Clip

If this function is on, it does the adjustment described under Adjust Range For Min Clip each time a measurement restarts. Therefore, in Continuous measurement mode, it only executes before the first measurement.

Key Path	AMPTD Y Scale, Attenuation
Remote Command	<code>[:SENSe] :POWer [:RF] :RANGe :OPTimize :ATTenuation OFF ON ELECTRical COMBined</code> <code>[:SENSe] :POWer [:RF] :RANGe :OPTimize :ATTenuation?</code>
Notes	This parameter is shared with old XA platform which uses AutoAtten. To keep the backward compatibility, ELECTRical and COMBined still can be used. Then, upon receiving ELECTRical and COMBined, these enums will be interpreted as aliases of ON. Then, when queried, ON will be returned.
Preset	OFF for Swept SA measurement; ON for all other measurements that support Pre-Adjust for Min Clip
State Saved	Saved in instrument state
Initial S/W Revision	Prior to A.02.00
Modified at S/W Revision	A.03.00

Peak to Average

The Peak to Average Ratio is used with the Range setting to optimize the level control in the instrument. The value is the ratio, in dB, of the peak power to the average power of the signal to be measured. A ratio of 0 should be used for sinusoidal signals; for 802.11g OFDM signals use 9 dB.

All Applications (Modes) will show the current value of Peak to Average ratio on the softkey. However, some applications will not permit changing the value. In these situations the softkey will be grayed-out.

Key Path	AMPTD Y Scale, Range
Remote Command	<code>[:SENSe] :POWer [:RF] :RANGe :PARatio <real></code>

	<code>[:SENSe] :POWer [:RF] :RANGe :PARatio?</code>
Example	POW:RANG:PAR 12 dB
Notes	In some Applications (Modes) this parameter will be read-only; meaning the value will appear on the softkey and query via SCPI, but not changeable. In such applications the softkey will be grayed-out. Attempting to change the value via SCPI will be ignored and no error message will be generated.
Preset	10 dB
State Saved	Saved in instrument state
Min	0 dB
Max	20 dB
Initial S/W Revision	A.13.00

Mixer Level Offset

Mixer level offset is an advanced setting to adjust target Range at the input mixer which in turn affects the signal level in the instrument's IF. This setting can be used when additional optimization is needed after setting Peak to Average ratio. Positive values of offset optimize noise performance over distortion, negative values optimize distortion performance over noise.

Key Path	AMPTD Y Scale, Range
Remote Command	<code>[:SENSe] :POWer [:RF] :RANGe :MIXer :OFFSet <real></code> <code>[:SENSe] :POWer [:RF] :RANGe :MIXer :OFFSet?</code>
Example	POW:RANG:MIX:OFFS -5 dB
Preset	0 dB
State Saved	Saved in instrument state
Min	-35 dB
Max	30 dB
Initial S/W Revision	A.13.00

Power Graph & Metrics View CDP Window Y Scale/Div

Sets the vertical display sensitivity measurement result in the Power Graph & Metrics window of the CDP view.

Key Path	AMPTD Y Scale
Mode	CDMA2K
Remote Command	<code>:DISPlay:CDPower:VIEW[1]:WINDow[1]:TRACe:Y[:SCALE]:PDIVision <real></code> <code>:DISPlay:CDPower:VIEW[1]:WINDow[1]:TRACe:Y[:SCALE]:PDIVision?</code>
Example	DISP:CDP:VIEW:WIND:TRAC:Y:PDIV 5.0 DISP:CDP:VIEW:WIND:TRAC:Y:PDIV?

Notes	Target window to control depends on the SubOpCode.
Remote Command Notes	Target window to control depends on the SubOpCode.
Preset	10.00
State Saved	Saved in instrument state.
Min	0.10
Max	20.00
Initial S/W Revision	Prior to A.02.00

YRef Position

Positions the Y-axis scale reference level at the top, center, or bottom of the display. Changing the reference position does not change the reference level value.

Key Path	AMPTD Y Scale
Initial S/W Revision	Prior to A.02.00

I/Q Error View Mag Error Window Y Ref Position

Positions the Y-axis scale reference level at the top, center or bottom of the display in the magnitude error window of the I/Q Error view.

Key Path	AMPTD Y Scale
Mode	CDMA2K
Remote Command	:DISPlay:CDPower:VIEW3:WINDow[1]:TRACe:Y[:SCALE]:RPOSition TOP CENTer BOTTom :DISPlay:CDPower:VIEW3:WINDow[1]:TRACe:Y[:SCALE]:RPOSition?
Example	DISP:CDP:VIEW3:WIND:TRAC:Y:RPOS CENT DISP:CDP:VIEW3:WIND:TRAC:Y:RPOS?
Notes	Target window to control depends on the SubOpCode.
Remote Command Notes	Target window to control depends on the SubOpCode.
Preset	CENTer
State Saved	Saved in instrument state.
Range	Top Ctr Bot
Initial S/W Revision	Prior to A.02.00

I/Q Error View Phase Error Window Y Ref Position

Positions the Y-axis scale reference level at the top, center or bottom of the display in the phase error window of the I/Q Error view.

Key Path	AMPTD Y Scale
Mode	CDMA2K
Remote Command	:DISPlay:CDPower:VIEW3:WINDow2:TRACe:Y[:SCALe]:RPOSition TOP CENTer BOTTom :DISPlay:CDPower:VIEW3:WINDow2:TRACe:Y[:SCALe]:RPOSition?
Example	DISP:CDP:VIEW3:WIND2:TRAC:Y:RPOS CENT DISP:CDP:VIEW3:WIND2:TRAC:Y:RPOS?
Notes	Target window to control depends on the SubOpCode.
Remote Command Notes	Target window to control depends on the SubOpCode.
Preset	CENTer
State Saved	Saved in instrument state.
Range	Top Ctr Bot
Initial S/W Revision	Prior to A.02.00

I/Q Error View Evm Window Y Ref Position

Positions the Y-axis scale reference level at the top, center or bottom of the display in the EVM window of the I/Q Error view.

Key Path	AMPTD Y Scale
Mode	CDMA2K
Remote Command	:DISPlay:CDPower:VIEW3:WINDow3:TRACe:Y[:SCALe]:RPOSition TOP CENTer BOTTom :DISPlay:CDPower:VIEW3:WINDow3:TRACe:Y[:SCALe]:RPOSition?
Example	DISP:CDP:VIEW3:WIND3:TRAC:Y:RPOS CENT DISP:CDP:VIEW3:WIND3:TRAC:Y:RPOS?
Notes	Target window to control depends on the SubOpCode.
Remote Command Notes	Target window to control depends on the SubOpCode.
Preset	BOTTom
State Saved	Saved in instrument state.
Range	Top Ctr Bot
Initial S/W Revision	Prior to A.02.00

Code Domain View Symbol Power Window Y Ref Position

Positions the Y-axis scale reference level at the top, center, or bottom of the display in the symbol power window of the code domain view.

Key Path	AMPTD Y Scale
----------	---------------

Mode	CDMA2K
Remote Command	:DISPlay:CDPower:VIEW4:WINDow2:TRACe:Y[:SCALe]:RPOSition TOP CENTer BOTTom :DISPlay:CDPower:VIEW4:WINDow2:TRACe:Y[:SCALe]:RPOSition?
Example	DISP:CDP:VIEW4:WIND2:TRAC:Y:RPOS CENT DISP:CDP:VIEW4:WIND2:TRAC:Y:RPOS?
Notes	Target window to control depends on the SubOpCode.
Remote Command Notes	Target window to control depends on the SubOpCode.
Preset	CENTER
State Saved	Saved in instrument state.
Range	Top Ctr Bot
Initial S/W Revision	Prior to A.02.00

Demod Bits View Symbol Power Window Y Ref Position

Positions the Y-axis scale reference level at the top, center, or bottom of the display in the symbol power window of the Demod Bits view.

Key Path	AMPTD Y Scale
Mode	CDMA2K
Remote Command	:DISPlay:CDPower:VIEW5:WINDow2:TRACe:Y[:SCALe]:RPOSition TOP CENTer BOTTom :DISPlay:CDPower:VIEW5:WINDow2:TRACe:Y[:SCALe]:RPOSition?
Example	DISP:CDP:VIEW5:WIND2:TRAC:Y:RPOS CENT DISP:CDP:VIEW5:WIND2:TRAC:Y:RPOS?
Notes	Target window to control depends on the SubOpCode.
Remote Command Notes	Target window to control depends on the SubOpCode.
Preset	CENTER
State Saved	Saved in instrument state.
Range	Top Ctr Bot
Initial S/W Revision	Prior to A.02.00

Auto Scaling

Toggles the Auto Scaling function between On and Off. When the Restart front panel key or Restart menu key under the Meas Control menu is pressed, this function automatically determines the scale per division and reference values based on the measurement results.

Key Path	AMPTD Y Scale
Initial S/W Revision	Prior to A.02.00

I/Q Error View Mag Error Window Y Auto Scaling

Toggles the Auto Scaling function between On and Off for the magnitude error window of the I/Q Error view.

Key Path	AMPTD Y Scale
Mode	CDMA2K
Remote Command	:DISPlay:CDPower:VIEW3:WINDow[1]:TRACe:Y[:SCALE]:COUPle 0 1 OFF ON :DISPlay:CDPower:VIEW3:WINDow[1]:TRACe:Y[:SCALE]:COUPle?
Example	DISP:CDP:VIEW3:WIND:TRAC:Y:COUP ON DISP:CDP:VIEW3:WIND:TRAC:Y:COUP?
Notes	Upon pressing the Restart front-panel key or Restart menu key under the Meas Control menu, the Auto Scaling function automatically determines the scale per division and reference values based on the measurement results if this parameter is set to On. When you set a value to either Scale/Div or Ref Value manually, Auto Scaling automatically changes to Off. Target window to control depends on the SubOpCode.
Remote Command Notes	Target window to control depends on the SubOpCode.
Couplings	See Notes
Preset	ON
State Saved	Saved in instrument state.
Range	Off On
Initial S/W Revision	Prior to A.02.00

I/Q Error View Phase Error Window Y Auto Scaling

Toggles the Auto Scaling function between On and Off in the phase error window of the I/Q Error view.

Key Path	AMPTD Y Scale
Mode	CDMA2K
Remote Command	:DISPlay:CDPower:VIEW3:WINDow2:TRACe:Y[:SCALE]:COUPle 0 1 OFF ON :DISPlay:CDPower:VIEW3:WINDow2:TRACe:Y[:SCALE]:COUPle?
Example	DISP:CDP:VIEW3:WIND2:TRAC:Y:COUP ON DISP:CDP:VIEW3:WIND2:TRAC:Y:COUP?
Notes	Upon pressing the Restart front-panel key or Restart menu key under the Meas Control menu, the Auto Scaling function automatically determines the scale per division and reference values based on the measurement results if this parameter is set to On. When you set a value to either Scale/Div or Ref Value manually, Auto Scaling automatically changes to Off. Target window to control depends on the SubOpCode.
Remote Command Notes	Target window to control depends on the SubOpCode.

Couplings	See Notes
Preset	ON
State Saved	Saved in instrument state.
Range	Off On
Initial S/W Revision	Prior to A.02.00

I/Q Error View Evm Window Y Auto Scaling

Toggles the Auto Scaling function between On and Off in the EVM window of the I/Q Error view

Key Path	AMPTD Y Scale
Mode	CDMA2K
Remote Command	:DISPlay:CDPower:VIEW3:WINDow3:TRACe:Y[:SCALE]:COUPle 0 1 OFF ON :DISPlay:CDPower:VIEW3:WINDow3:TRACe:Y[:SCALE]:COUPle?
Example	DISP:CDP:VIEW3:WIND3:TRAC:Y:COUP ON DISP:CDP:VIEW3:WIND3:TRAC:Y:COUP?
Notes	Upon pressing the Restart front-panel key or Restart menu key under the Meas Control menu, the Auto Scaling function automatically determines the scale per division and reference values based on the measurement results if this parameter is set to On. When you set a value to either Scale/Div or Ref Value manually, Auto Scaling automatically changes to Off. Target window to control depends on the SubOpCode.
Remote Command Notes	Target window to control depends on the SubOpCode.
Couplings	See Notes
Preset	ON
State Saved	Saved in instrument state.
Range	Off On
Initial S/W Revision	Prior to A.02.00

Code Domain View Symbol Power Window Y Auto Scaling

Toggles the Auto Scaling function between On and Off in the symbol power window of the code domain view.

Key Path	AMPTD Y Scale
Mode	CDMA2K
Remote Command	:DISPlay:CDPower:VIEW4:WINDow2:TRACe:Y[:SCALE]:COUPle 0 1 OFF ON :DISPlay:CDPower:VIEW4:WINDow2:TRACe:Y[:SCALE]:COUPle?
Example	DISP:CDP:VIEW4:WIND2:TRAC:Y:COUP ON DISP:CDP:VIEW4:WIND2:TRAC:Y:COUP?

Notes	Upon pressing the Restart front-panel key or Restart menu key under the Meas Control menu, the Auto Scaling function automatically determines the scale per division and reference values based on the measurement results if this parameter is set to On. When you set a value to either Scale/Div or Ref Value manually, Auto Scaling automatically changes to Off. Target window to control depends on the SubOpCode.
Remote Command Notes	Target window to control depends on the SubOpCode.
Couplings	See Notes
Preset	ON
State Saved	Saved in instrument state.
Range	Off On
Initial S/W Revision	Prior to A.02.00

Demod Bits View Symbol Power Window Y Auto Scaling

Toggles the Auto Scaling function between On and Off in the symbol power window of the Demod Bits function view.

Key Path	AMPTD Y Scale
Mode	CDMA2K
Remote Command	:DISPlay:CDPower:VIEW5:WINDow2:TRACe:Y[:SCALe]:COUPle 0 1 OFF ON :DISPlay:CDPower:VIEW5:WINDow2:TRACe:Y[:SCALe]:COUPle?
Example	DISP:CDP:VIEW5:WIND2:TRAC:Y:COUP ON DISP:CDP:VIEW5:WIND2:TRAC:Y:COUP?
Notes	Upon pressing the Restart front-panel key or Restart menu key under the Meas Control menu, the Auto Scaling function automatically determines the scale per division and reference values based on the measurement results if this parameter is set to On. When you set a value to either Scale/Div or Ref Value manually, Auto Scaling automatically changes to Off. Target window to control depends on the SubOpCode.
Remote Command Notes	Target window to control depends on the SubOpCode.
Couplings	See Notes
Preset	ON
State Saved	Saved in instrument state.
Range	Off On
Initial S/W Revision	Prior to A.02.00

Auto Couple

The Auto Couple feature provides a quick and convenient way to automatically couple multiple instrument settings. This helps ensure accurate measurements and optimum dynamic range. When the Auto Couple feature is activated, either from the front panel or remotely, all parameters of the current measurement that have an Auto/Manual mode are set to Auto mode and all measurement settings dependent on (or coupled to) the Auto/Man parameters are automatically adjusted for optimal performance.

However, the Auto Couple key actions are confined to the current measurement only. It does not affect other measurements in the mode, and it does not affect markers, marker functions, or trace or display attributes.

See "[More Information](#)" on page 1492

Key Path	Front-panel key
Remote Command	:COUPLe ALL NONE
Example	:COUP ALL
Notes	:COUPLe ALL puts all Auto/Man parameters in Auto mode (equivalent to pressing the Auto Couple key). :COUPLE NONE puts all Auto/Man parameters in manual mode. It decouples all the coupled instrument parameters and is not recommended for making measurements.
Initial S/W Revision	Prior to A.02.00

More Information

There are two types of functions that have Auto/Manual modes.

Auto/Man Active Function keys

An Auto/Man toggle key controls the binary state associated with an instrument parameter by toggling between Auto (where the parameter is automatically coupled to the other parameters it is dependent upon) and Man (where the parameter is controlled independent of the other parameters), as well as making the parameter the active function. The current mode is indicated on the softkey with either Auto or Man underlined as illustrated below.

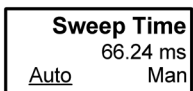

vsd07

Auto/Man 1-of-N keys

An Auto/Man 1-of-N key allows you to manually pick from a list of parameter values, or place the function in Auto, in which case the value is automatically selected (and indicated) as shown below. If in Auto, Auto is underlined on the calling key. If in manual operation, manual is indicated on the calling key. But the calling key does not actually toggle the function, it simply opens the menu.

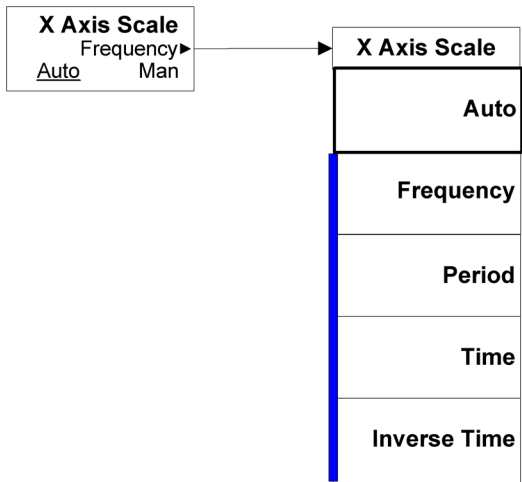

vsd08

BW

There is no BW functionality supported in the Code Domain measurement. The front-panel key displays a blank menu when pressed.

Key Path	Front-panel key
Initial S/W Revision	Prior to A.02.00

Cont (Continuous Measurement/Sweep)

Sets the analyzer for Continuous measurement operation. The single/continuous state is Meas Global so the setting will affect all measurements. If you are Paused, pressing Cont does a Resume.

Key Path	Front-panel key
Remote Command	:INITiate:CONTinuous OFF ON 0 1 :INITiate:CONTinuous?
Example	:INIT:CONT 0 puts analyzer in Single measurement operation. :INIT:CONT 1 puts analyzer in Continuous measurement operation
Preset	ON (Note that SYST:PRESet sets INIT:CONT to ON but *RST sets INIT:CONT to OFF)
State Saved	Saved in instrument state
Backwards Compatibility Notes	For Spectrum Analysis mode in ESA and PSA, there is no Cont hardkey, instead there is a Sweep Single/Cont key. In these analyzers, switching the Sweep Single/Cont key from Single to Cont restarts averages (displayed average count reset to 1), but does not restart Max Hold and Min Hold. The X-Series has Single and Cont keys in place of the SweepSingleCont key. In the X-Series, if in single measurement, the Cont key (and INIT:CONT ON) switches to continuous measurement, but never restarts a measurement and never resets a sweep.
Initial S/W Revision	Prior to A.02.00

In Swept SA Measurement (Spectrum Analysis Mode):

The analyzer takes repetitive sweeps, averages, measurements, etc., when in Continuous mode. When the average count reaches the Average/Hold Number the count stops incrementing, but the analyzer keeps sweeping. See the Trace/Detector section for the averaging formula used both before and after the Average/Hold Number is reached. The trigger condition must be met prior to each sweep. The type of trace processing for multiple sweeps, is set under the Trace/Detector key, with choices of Trace Average, Max Hold, or Min Hold.

In Other Measurements/Modes:

With Avg/Hold Num (in the Meas Setup menu) set to Off or set to On with a value of 1, a sweep is taken after the trigger condition is met; and the analyzer continues to take new sweeps after the current sweep has completed and the trigger condition is again met. However, with Avg/Hold Num set to On with a value >1, multiple sweeps (data acquisitions) are taken for the measurement. The trigger condition must be met prior to each sweep. The sweep is not stopped when the average count k equals the number N set for Avg/Hold Num is reached, but the number k stops incrementing. A measurement average usually applies to all traces, marker results, and numeric results. But sometimes it only applies to the numeric results.

If the analyzer is in Single measurement, pressing the Cont key does not change k and does not cause the sweep to be reset; the only action is to put the analyzer into Continuous measurement operation.

If it is already in continuous sweep:

the INIT:CONT 1 command has no effect

12 Code Domain Measurement
Cont (Continuous Measurement/Sweep)

the INIT:CONT 0 command will place the analyzer in Single Sweep but will have no effect on the current sequence until $k = N$, at which point the current sequence will stop and the instrument will go to the idle state.

File

See "File" on page 184

FREQ Channel

Accesses a menu of keys that allow you to control the Frequency and Channel parameters of the instrument.

Some features in the Frequency menu are the same for all measurements – they do not change as you change measurements. Settings like these are called “Meas Global” and are unaffected by Meas Preset. For example, the Center Freq setting is the same for all measurements - it does not change as you change measurements.

Key Path	Front-panel key
Initial S/W Revision	Prior to A.02.00

Center Freq

Sets the frequency that corresponds to the horizontal center of the graticule (when frequency Scale Type is set to linear). While adjusting the Center Frequency the Span is held constant, which means that both Start Frequency and Stop Frequency will change.

Pressing Center Freq also sets the frequency entry mode to Center/Span. In Center/Span mode, the center frequency and span values are displayed below the graticule, and the default active function in the Frequency menu is Center Freq.

The center frequency setting is the same for all measurements within a mode, that is, it is Meas Global. Some modes are also able to share a Mode Global center frequency value. If this is the case, the Mode will have a Global Settings key in its Mode Setup menu.

The Center Freq function sets (and queries) the Center Frequency for the currently selected input. If your analyzer has multiple inputs, and you select another input, the Center Freq changes to the value for that input. SCPI commands are available to directly set the Center Freq for a specific input.

Center Freq is remembered as you go from input to input. Thus you can set a Center Freq of 10 GHz with the RF Input selected, change to BBIQ and set a Center Freq of 20 MHz, then switch to External Mixing and set a Center Freq of 60 GHz, and when you go back to the RF Input the Center Freq will go back to 10 GHz; back to BBIQ and it is 20 MHz; back to External Mixing and it is 60 GHz.

See ["RF Center Freq" on page 1501](#)

See [Ext Mix Center Freq](#)

See ["I/Q Center Freq" on page 1503](#)

See ["Center Frequency Presets" on page 1499](#)

Key Path	FREQ Channel
Scope	Meas Global
Remote Command	<code>[:SENSe] :FREQuency:CENTer <freq></code> <code>[:SENSe] :FREQuency:CENTer?</code>
Example	<code>FREQ:CENT 50 MHz</code>

	FREQ:CENT UP changes the center frequency to 150 MHz if you use FREQ:CENT:STEP 100 MHz to set the center frequency step size to 100 MHz FREQ:CENT?
Notes	This command sets either the RF or I/Q Center Frequency depending on the selected input. For RF input it is equivalent to FREQ:RF:CENT For I/Q input it is equivalent to FREQ:IQ:CENT Preset and Max values are dependent on Hardware Options (5xx) If no terminator (e.g. MHz) is sent the terminator Hz is used. If a terminator with unit other than Frequency is used, an invalid suffix error message is generated.
Dependencies	The Center Frequency can be limited by Start or Stop Freq limits, if the Span is so large that Start or Stop reach their limit.
Couplings	When operating in "swept span", any value of the Center Frequency or Span that is within the frequency range of the analyzer is allowed when the value is being set through the front panel numeric key pad or the SCPI command. The other parameter is forced to a different value if needed, to keep the Start and the Stop Frequencies within the analyzer's frequency range
Preset	Depends on instrument maximum frequency, mode, measurement, and selected input. See "Center Frequency Presets" on page 1499 and "RF Center Freq" on page 1501 and Ext Mix Center Freq and "I/Q Center Freq" on page 1503.
State Saved	Saved in instrument state
Min	Depends on instrument maximum frequency, mode, measurement, and selected input.. See "Center Frequency Presets" on page 1499 and "RF Center Freq" on page 1501 and "I/Q Center Freq" on page 1503.
Max	Depends on instrument maximum frequency, mode, measurement, and selected input.. See "Center Frequency Presets" on page 1499 and "RF Center Freq" on page 1501 and "I/Q Center Freq" on page 1503.
Default Unit	Hz
Status Bits/OPC	Non-overlapped
Dependencies	
Initial S/W Revision	Prior to A.02.00

Center Frequency Presets

The following table provides the Center Frequency Presets for the Spectrum Analyzer mode, and the Max Freq, for the various frequency options:

Freq Option	CF after Mode Preset	Stop Freq after Mode Preset	Max Freq (can't tune above)

12 Code Domain Measurement
 FREQ Channel

503 (all but N9000A)	1.805 GHz	3.6 GHz	3.7 GHz
503 (N9000A)	1.505 GHz	3.0 GHz	3.08 GHz
504 (M9420A)	1 GHz	3.8GHz	3.88 GHz
506 (M9420A)	1 GHz	6.0GHz	6.08 GHz
507 (all but N9000A)	3.505 GHz	7.0 GHz	7.1 GHz
507 (N9000A)	3.755 GHz	7.5 GHz	7.58 GHz
508 (all but N9038A)	1.805 GHz	3.6 GHz	8.5 GHz
508 (N9038A)	4.205 GHz	8.4 GHz	8.5 GHz
513	6.805 GHz	13.6 GHz	13.8 GHz
526 (all but N9000A and N9038A)	13.255 GHz	26.5 GHz	27.0 GHz
526 (N9000A)	13.255 GHz	26.5 GHz	26.55 GHz
526 (N9038A)	1.805 GHz	3.6 GHz	27.0 GHz
532	16.005 GHz	32.0 GHz	32.5 GHz
543	21.505 GHz	43.0 GHz	TBD
544	22.005 GHz	44.0 GHz	44.5 GHz
550	25.005 GHz	50.0 GHz	51 GHz

Input 2:

Model	CF after Mode Preset	Stop Freq after Mode Preset	Max Freq (can't tune above)
N9000A opt C75	0.7505GHz	1.5 GHz	1.58 GHz
N9038A	505 MHz	1 GHz	1.000025 GHz

Tracking Generator Frequency Limits (N9000A only):

Tracking Generator Option	Min Freq (clips to this freq when turn TG on and can't tune below while TG on)	If above this Freq, Stop Freq clipped to this Freq when TG turned on	Max Freq (can't tune above) while TG on
T03	9 kHz	3.0 GHz	3.08 GHz
T06	9 kHz	6.0 GHz	6.05 GHz

The following table shows the Center Frequency Presets for modes other than Spectrum Analyzer:

Mode	CF Preset for RF
WCDMA	1 GHz
WIMAXOFDMA,	1 GHz
BASIC	1 GHz
ADEMOD	1 GHz
VSA	1 GHz
TDSCDMA	1 GHz
PNOISE	1 GHz
LTE	1 GHz
LTETDD	1 GHz
MSR	1 GHz
GSM	935.2 MHz
NFIGURE	1.505 GHz

RF Center Freq

SCPI command for specifying the RF Center Frequency. This command will set the Center Frequency to be used when the RF input is selected, even if the RF input is not the input that is selected at the time the command is sent. Note that the Center Freq function in the Frequency menu on the front panel always applies to the currently selected input.

Scope	Meas Global
Remote Command	<code>[:SENSe] :FREQuency:RF:CENTer <freq></code> <code>[:SENSe] :FREQuency:RF:CENTer?</code>
Example	FREQ:RF:CENT 30 MHz
Notes	This command is the same in all modes, but the parameter is Measurement Global. So the value is independent in each mode and common across all the measurements in the mode.
Dependencies	If the electronic/soft attenuator is enabled, any attempt to set Center Frequency such that the Stop Frequency would be >3.6 GHz fails and results in an advisory message. If the equivalent SCPI

	command is sent, this same message is generated as part of a “-221, Settings conflict” warning. If Source Mode is set to Tracking, and the Max or Min Center Freq is therefore limited by the limits of the source, a warning message is generated, “Data out of range;clipped to source max/min” if these limits are exceeded. Note that for an external source, these limits can be affected by the settings of Source Numerator, Source Denominator and Power Sweep.
Preset	See table above
State Saved	Saved in instrument state.
Min	-79.999995 MHz, unless Source Mode is set to Tracking, in which case it is limited by the minimum frequency of the Source
Max	See table above. Basically instrument maximum frequency – 5 Hz. Note that, if the Source Mode is set to Tracking, the effective instrument maximum frequency may be limited by the source maximum frequency. If the knob or step keys are being used, also depends on the value of the other three interdependent parameters Span, Start Frequency and Stop Frequency
Initial S/W Revision	Prior to A.02.00
Modified at S/W Revision	A.03.00

Ext Mix Center Freq

SCPI command for specifying the External Mixer Center Frequency. This command will set the Center Frequency to be used when the External Mixer is selected, even if the External Mixer input is not the input which is selected at the time the command is sent. Note that the Center Freq function in the Frequency menu on the front panel always applies to the currently selected input.

Scope	Meas Global
Remote Command	<code>[:SENSE] :FREQuency:EMIXer:CENTer <freq></code> <code>[:SENSE] :FREQuency:EMIXer:CENTer?</code>
Example	<code>:FREQ:EMIX:CENT 60 GHz</code> <code>:FREQ:EMIX:CENT?</code>
Notes	This command is the same in all modes, but the parameter is Measurement Global. So the value is independent in each mode and common across all the measurements in the mode.
Couplings	When returning to External Mixing after having been switched to one of the other inputs (e.g., RF), you will come back into the settings that you had when you left External Mixing. So you will come back to the band you were in with the Center Frequency that you had. However, Span is not an input-dependent parameter, therefore you will bring the span over from the other input. Therefore, the analyzer comes back with the span from the previous input, limited as necessary by the current mixer setup.
Preset	When a Mode Preset is performed while in External Mixing, the Start frequency of the current Mode is set to the nominal Min Freq of the lowest harmonic range in the Harmonic Table for the current mixer setup. Similarly, the Stop frequency of the current Mode is set to the nominal Max Freq of the highest harmonic range in the Harmonic Table. The Center Freq thus presets to the point arithmetically equidistant from these two frequencies.

	<p>If the current measurement has a limited Span available to it, and cannot achieve the Span shown in the table (Span=Stop Freq - Start Freq), the analyzer uses the maximum Span the measurement allows, and still sets the Center Freq to the midpoint of the Start and Stop Freq values in the Harmonic Table.</p> <p>When Restore Input/Output Defaults is performed, the mixer presets to the 11970A, whose Start and Stop frequencies are 26.5 and 40 GHz respectively. The center of these two frequencies is 33.25 GHz.</p> <p>Therefore, after a Restore Input/Output Defaults, if you go into External Mixing and do a Mode Preset while in the Spectrum Analyzer Mode, the resulting Center Freq is 33.25 GHz.</p>
State Saved	Saved in instrument state.
Min	The minimum frequency in the currently selected mixer band + 5 Hz
Max	The maximum frequency in the currently selected mixer band - 5 Hz If the knob or step keys are being used, also depends on the value of the other three interdependent parameters Span, Start Frequency and Stop Frequency
Initial S/W Revision	A.08.01

I/Q Center Freq

SCPI command for specifying the I/Q Center Frequency. This command will set the Center Frequency to be used when the I/Q input is selected, even if the I/Q input is not the input which is selected at the time the command is sent. Note that the Center Freq function in the Frequency menu on the front panel always applies to the currently selected input.

Scope	Meas Global
Remote Command	[:SENSe] :FREQuency:IQ:CENTer <freq> [:SENSe] :FREQuency:IQ:CENTer?
Example	FREQ:IQ:CEN: 30 MHz
Notes	This command is the same in all modes, but the parameter is Measurement Global. So the value is independent in each mode and common across all the measurements in the mode.
Preset	0 Hz
State Saved	Saved in instrument state.
Min	-40.049995 MHz
Max	40.049995 MHz
Initial S/W Revision	Prior to A.02.00

CF Step

Changes the step size for the center frequency and start and stop frequency functions. Once a step size has been selected and the center frequency function is active, the step keys (and the UP|DOWN parameters for Center Frequency from remote commands) change the center frequency by the step-size value. The step size function is useful for finding harmonics and sidebands beyond the current frequency span of the analyzer.

Note that the start and stop frequencies also step by the CF Step value.

Key Path	FREQ Channel
Remote Command	[:SENSe]:FREQuency:CENTer:STEP[:INCRement] <freq> [:SENSe]:FREQuency:CENTer:STEP[:INCRement]? [:SENSe]:FREQuency:CENTer:STEP:AUTO OFF ON 0 1 [:SENSe]:FREQuency:CENTer:STEP:AUTO?
Example	FREQ:CENt:STEP:AUTO ON FREQ:CENt:STEP 500 MHz FREQ:CENt UP increases the current center frequency value by 500 MHz FREQ:CENt:STEP? FREQ:CENt:STEP:AUTO?
Notes	Preset and Max values are depending on Hardware Options (503, 507, 508, 513, 526)
Notes	Preset and Max values are dependent on Hardware Options (5xx)
Dependencies	Freq Offset is not available in External Mixing. In this case the Freq Offset key is grayed out and shows a value of zero. It will once again be available, and show the previously set value, when you return to the RF Input.
Dependencies	Span, RBW, Center frequency If the electronic/soft attenuator is enabled, any attempt to change the value of the center frequency >3.6 GHz by pressing the Up-arrow key, fails and results in an advisory message. If the equivalent SCPI command is sent, this same message is generated as part of a “-221, Settings conflict” warning.
Couplings	When auto-coupled in a non-zero span, the center frequency step size is set to 10% of the span. When auto-coupled in zero span, the center frequency step size is set to the equivalent -3 dB RBW value.
Preset	Auto ADEMOD: 1 MHz ON
State Saved	Saved in instrument state
Min	– (the maximum frequency of the instrument). That is, 27 GHz max freq instrument has a CF step range of +/- 27 GHz. Note that this is the maximum frequency given the current settings of the instrument, so in External Mixing, for example, it is the maximum frequency of the current mixer band.
Max	The maximum frequency of the instrument. That is, 27 GHz max freq instrument has a CF step range of +/- 27 GHz. Note that this is the maximum frequency given the current settings of the instrument, so in External Mixing, for example, it is the maximum frequency of the current mixer band.
Default Unit	Hz
Status Bits/OPC dependencies	non-overlapped
Initial S/W Revision	Prior to A.02.00
Modified at S/W Revision	A.03.00

12 Code DomainMeasurement
Input/Output

Input/Output

See "[Input/Output](#)" on page 138

Marker

Accesses a menu that enables you to select, set up and control the markers for the current measurement. See the "Marker Functions" section for more information

Key Path	Front Panel Key
Initial S/W Revision	Prior to A.02.00

Select Marker

Displays 12 markers available for selection.

Key Path	Marker
Initial S/W Revision	Prior to A.02.00

Marker Type

Sets the marker control mode. If the selected marker is Off, pressing Marker sets it to Normal and places it at the start of the screen on the trace determined by the Marker Trace rules. At the same time, reference value of the selected marker appears on the Active Function area.

Active Function Display:

Marker symbol value at I/Q Symbol Polar Vector graph

Marker X-axis value at other graphs

Default Active Function: the active function for the selected marker's current control mode. If the current control mode is Off, there is no active function and the active function is turned off.

The marker X axis value entered in the active function area displays the marker value to its full entered precision.

When Marker Trace is 'POLar'(I/Q Polar), 'Delta' is not supported.

Key Path	Marker
Remote Command	:CALCulate:CDPower:MARKer[1] 2 ...12:MODE POSition DELTA OFF :CALCulate:CDPower:MARKer[1] 2 ...12:MODE?
Example	CALC:CDP:MARK:MODE POS CALC:CDP:MARK:MODE?
Notes	If the selected marker is Off, pressing Marker sets it to Normal and places it at the start of the screen on the trace determined by the Marker Trace rules. At the same time, Marker X Axis Value appears on the Active Function area. Default Active Function: the active function for the selected marker's current control mode. If the current control mode is Off, there is no active function and the active function is turned off. Active Function Display:

	Marker symbol value at I/Q Symbol Polar Vector graph Marker X-axis value at other graphs The marker X axis value entered in the active function area displays the marker value to its full entered precision.
Remote Command Notes	NORMAL is changed to POSITION in the new SA.
Preset	OFF
State Saved	Saved in instrument state.
Range	Normal Delta Off
Initial S/W Revision	Prior to A.02.00

Properties

Accesses a menu that enables you to select a relative marker and marker trace

Key Path	Marker
Initial S/W Revision	Prior to A.02.00

Select Marker

Displays 12 markers available for selection.

Key Path	Marker
Initial S/W Revision	Prior to A.02.00

Relative To

Selects the marker the selected marker is relative to (its reference marker).

Key Path	Marker, Properties
Mode	CDMA2K
Remote Command	:CALCulate:CDPower:MARKer[1] 2 ...12:REFerence <integer> :CALCulate:CDPower:MARKer[1] 2 ...12:REFerence?
Example	CALC:CDP:MARK:REF 4 CALC:CDP:MARK:REF?
Notes	A marker cannot be relative to itself so that choice is grayed out, and if sent from SCPI generates error -221: "Settings conflict; marker cannot be relative to itself."
Remote Command Notes	When queried a single value is returned (the specified marker numbers relative marker). A marker cannot be relative to itself so that choice is grayed out, and if sent from SCPI generates error -221: "Settings conflict; marker cannot be relative to itself." You must be in the Spectrum Analysis mode, GSM mode to use this command. Use

	INSTRument:SElect to set the mode.
Preset	2 3 4 5 6 7 8 9 10 11 12 1
State Saved	Saved in instrument state.
Min	1
Max	12
Initial S/W Revision	Prior to A.02.00

Marker Trace

Assigns the specified marker to the designated trace.

Key Path	Marker, Properties
Mode	CDMA2K
Remote Command	:CALCulate:CDPower:MARKer[1] 2 ...12:TRACe CDPower EVM MERRor PERRor SPOWer CPOWer CDError POLar :CALCulate:CDPower:MARKer[1] 2 ...12:TRACe?
Example	CALC:CDP:MARK:TRACE POL CALC:CDP:MARK:TRACE?
Preset	CDPower
State Saved	Saved in instrument state.
Range	Code Domain Power Code Domain Error Symbol Power Chip Power EVM Phase Error Mag Error Polar
Initial S/W Revision	Prior to A.02.00

Couple Markers

Toggles the state of the markers to be coupled On or Off. When this function is true (On), moving any marker causes an equal X-axis movement of every other marker except those located to the polar trace, and Chip value of the marker located to the polar trace, which is not Off, including Fixed markers. "Equal X Axis movement" refers to the difference between each marker's X Axis value (in the fundamental x-axis units of the trace that marker is on) and the X Axis value of the marker being moved (in the same fundamental x-axis units). This may result in markers going off screen

See Couple Marker in the "Marker" section for more information.

Key Path	Marker
Mode	CDMA2K
Remote Command	:CALCulate:CDPower:MARKer:COUPlE[:STATe] ON OFF 1 0 :CALCulate:CDPower:MARKer:COUPlE[:STATe]?

Example	CALC:CDP:MARK:COUP ON CALC:CDP:MARK:COUP?
Preset	OFF
State Saved	Saved in instrument state.
Range	On Off
Initial S/W Revision	Prior to A.02.00

All Markers Off

Turns off all markers.

Key Path	Marker
Mode	CDMA2K
Remote Command	:CALCulate:CDPower:MARKer:AOFF
Example	CALC:CDP:MARK:AOFF
Initial S/W Revision	Prior to A.02.00

Marker Symbol Value (Remote Command only)

Sets the marker symbol value in the current marker for the trace of I/Q symbol polar vector. It has no effect if the control mode is Off, but is the SCPI equivalent of entering an X value if the control mode is Normal.

This command is only valid when Marker Trace is 'POLar'(I/Q symbol polar vector). And, for other Marker Trace, it's not valid and ignored.

Mode	CDMA2K
Remote Command	:CALCulate:CDPower:MARKer[1] 2 ...12:SYMBOL <real> :CALCulate:CDPower:MARKer[1] 2 ...12:SYMBOL?
Example	CALC:CDP:MARK:SYMB 1.0 CALC:CDP:MARK:SYMB?
Notes	If no suffix is sent, it uses 'symbols'. If a suffix is not 'symbols', an error "Invalid suffix" is generated. The query returns the marker's 'symbol' value in the trace if the control mode is Normal. The query is returned in 'symbols'. If the marker is Off the response is not a number.
Remote Command Notes	This parameter has different meaning between the cases where the marker trace is set to Symbol I/Q Polar Vector and others. In the Symbol I/Q Polar Vector Graph, X Axis Value is also the measured value, so this parameter is meaningful only when the control mode is set to Normal
Preset	Start point of the trace on the display window
State Saved	No
Min	-9.9E+37

Max	9.9E+37
Initial S/W Revision	Prior to A.02.00

Marker X Axis Value (Remote Command only)

Sets the marker X Axis value in the current marker X Axis Scale unit. It has no effect if the control mode is Off, but is the SCPI equivalent of entering an X value if the control mode is Normal or Delta.

This command is not valid when Marker Trace is 'POLar'(I/Q symbol polar vector) and ignored. For Marker Trace 'POLar'(I/Q symbol polar vector), Marker Symbol Value is supported instead.

Mode	CDMA2K
Remote Command	:CALCulate:CDPower:MARKer[1] 2 ...12:X <real> :CALCulate:CDPower:MARKer[1] 2 ...12:X?
Example	CALC:CDP:MARK3:X 0.0 CALC:CDP:MARK3:X?
Notes	If no suffix is sent it uses the fundamental units for the current marker X Axis Scale. If a suffix is sent that does not match the current marker X Axis Scale unit, an error "Invalid suffix" is generated. The query returns the marker's absolute X Axis value if the control mode is Normal, or the offset from the marker's reference marker if the control mode is Delta. The query is returned in the fundamental units for the current marker X Axis scale: Hz for Frequency and Inverse Time, seconds for Period and Time. If the marker is Off the response is not a number.
Preset	After a preset, all Markers are turned OFF, so Marker X Axis Value query returns a not a number (NAN).
State Saved	No
Min	-9.9E+37
Max	9.9E+37
Initial S/W Revision	Prior to A.02.00

Marker X Axis Position (Remote Command only)

Sets the marker X position in trace points. It has no effect if the control mode is Off, but is the SCPI equivalent of entering a value if the control mode is Normal or Delta - except in trace points rather than X Axis Scale units. The entered value is immediately translated into the current X Axis Scale units for setting the value of the marker.

Mode	CDMA2K
Remote Command	:CALCulate:CDPower:MARKer[1] 2 ...12:X:POsition <real> :CALCulate:CDPower:MARKer[1] 2 ...12:X:POsition?
Example	CALC:CDP:MARK10:X:POS 0.0 CALC:CDP:MARK10:X:POS?
Notes	The query returns the marker's absolute X Axis value in trace points if the control mode is Normal, or

	the offset from the marker's reference marker in trace points if the control mode is Delta. The value is returned as a real number, not an integer, corresponding to the translation from X Axis Scale units to trace points (see "Fractional Trace Points", above). If the marker is Off the response is not a number.
Preset	After a preset, all Markers are turned OFF, so Marker X Axis Value query does not return a number (NAN).
State Saved	No
Min	-9.9E+37
Max	9.9E+37
Initial S/W Revision	Prior to A.02.00

Marker Y Axis Value (Remote Command only)

Queries the marker Y Axis value in the current marker Y Axis unit.

Mode	CDMA2K
Remote Command	:CALCulate:CDPower:MARKer[1] 2 ...12:Y?
Example	CALC:CDP:MARK11:Y?
Preset	Result dependant on markers setup and signal source
State Saved	No
Backwards Compatibility SCPI	:CALCulate:CDPower:MARKer[1] 2 ...12:FUNCTION:RESult?
Initial S/W Revision	Prior to A.02.00

Backward Compatibility SCPI Commands

Sets or queries the state of a marker. Setting a marker which is OFF to state ON or 1 puts it in Normal mode and places it at the left of the screen.

Mode	CDMA2K
Remote Command	:CALCulate:CDPower:MARKer[1] 2 ...12:STATe OFF ON 0 1 :CALCulate:CDPower:MARKer[1] 2 ...12:STATe?
Example	CALC:CDP:MARK3:STATe ON CALC:CDP:MARK3:STAT?
Preset	OFF
State Saved	Saved in instrument state.
Range	On Off
Initial S/W Revision	Prior to A.02.00

Marker Function

There are no Marker Function operations supported in the Code Domain measurement. The front-panel key displays a blank menu when pressed.

Key Path	Front panel key
Initial S/W Revision	Prior to A.02.00

Marker To

Accesses menu keys that can copy the current marker value into other instrument parameter, for example Despread. If the currently selected marker is not on when the front panel key is pressed, it is turned on at the center of the screen as a normal type marker.

Key Path	Front panel key
Initial S/W Revision	Prior to A.02.00

Mkr -> Despread

Executes post process for selected marker.

Key Path	Marker ->, Mkr->Despread
Mode	CDMA2K
Remote Command	:CALCulate:CDPower:MARKer[1] 2 ...12[:SET]:DESPread
Example	CALC:CDP:MARK4:SET:DESP
Notes	This function is available only when the marker trace is 'CDPower'
Initial S/W Revision	Prior to A.02.00

Meas

The information in this section is common to all measurements. For key and remote command information for a specific measurement, refer to the section that describes the measurement of interest.

Measurements available under the Meas key are specific to the current Mode.

When viewing Help for measurements, note the following:

NOTE

Operation for some keys differs between measurements. The information displayed in Help pertains to the current measurement. To see how a key operates in a different measurement, exit Help (press the Cancel Esc key), select the measurement, then reenter Help (press the Help key) and press that key.

Key Path	Front-panel key
Initial S/W Revision	Prior to A.02.00

Remote Measurement Functions

This section contains the following topics:

"Measurement Group of Commands" on page 2016

"Current Measurement Query (Remote Command Only)" on page 2018

"Limit Test Current Results (Remote Command Only)" on page 2018

"Data Query (Remote Command Only)" on page 2018

"Calculate/Compress Trace Data Query (Remote Command Only)" on page 2019

"Calculate Peaks of Trace Data (Remote Command Only)" on page 2024

"Hardware-Accelerated Fast Power Measurement (Remote Command Only)" on page 2025

"Format Data: Numeric Data (Remote Command Only)" on page 2039

"Format Data: Byte Order (Remote Command Only)" on page 2040

Initial S/W Revision	Prior to A.02.00
----------------------	------------------

Measurement Group of Commands

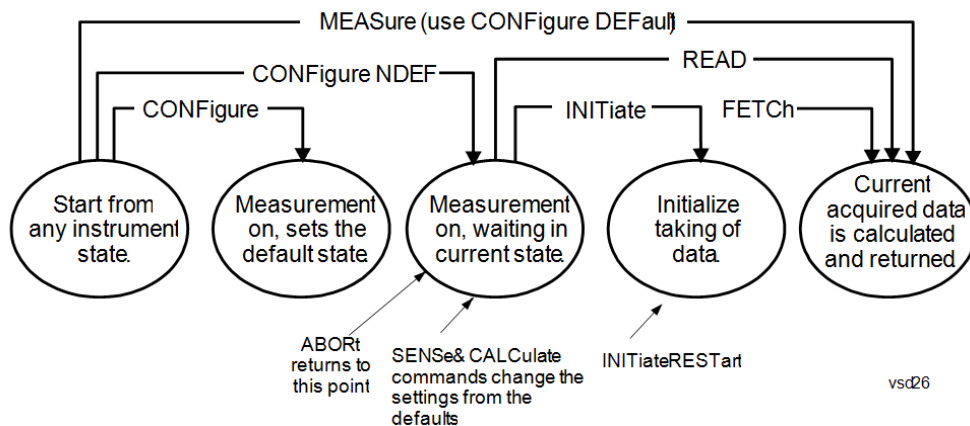

Measure Commands:

:MEASure:<measurement>[n]?

This is a fast single-command way to make a measurement using the factory default instrument settings. These are the settings and units that conform to the Mode Setup settings (e.g. radio standard) that you have currently selected.

- Stops the current measurement (if any) and sets up the instrument for the specified measurement using the factory defaults
- Initiates the data acquisition for the measurement
- Blocks other SCPI communication, waiting until the measurement is complete before returning results.
- If the function does averaging, it is turned on and the number of averages is set to 10.
- After the data is valid it returns the scalar results, or the trace data, for the specified measurement. The type of data returned may be defined by an [n] value that is sent with the command.
- The scalar measurement results will be returned if the optional [n] value is not included, or is set to 1. If the [n] value is set to a value other than 1, the selected trace data results will be returned. See each command for details of what types of scalar results or trace data results are available.
- ASCII is the default format for the data output. (Older versions of Spectrum Analysis and Phase Noise mode measurements only use ASCII.) The binary data formats should be used for handling large blocks of data since they are smaller and faster than the ASCII format. Refer to the FORMat:DATA command for more information.

If you need to change some of the measurement parameters from the factory default settings you can set up the measurement with the CONFigure command. Use the commands in the SENSE:<measurement> and CALCulate:<measurement> subsystems to change the settings. Then you can use the READ? command to initiate the measurement and query the results.

If you need to repeatedly make a given measurement with settings other than the factory defaults, you can use the commands in the SENSE:<measurement> and CALCulate:<measurement> subsystems to set up the measurement. Then use the READ? command to initiate the measurement and query results.

Measurement settings persist if you initiate a different measurement and then return to a previous one. Use READ:<measurement>? if you want to use those persistent settings. If you want to go back to the default settings, use MEASure:<measurement>?.

Configure Commands:

:CONFigure:<measurement>

This command stops the current measurement (if any) and sets up the instrument for the specified measurement using

the factory default instrument settings. It does not initiate the taking of measurement data unless INIT:CONTInuous is ON. If you change any measurement settings after using the CONFigure command, the READ command can be used to initiate a measurement without changing the settings back to their defaults.

In the Swept SA measurement in Spectrum Analyzer mode the CONFigure command also turns the averaging function on and sets the number of averages to 10 for all measurements.

:CONFigure: <measurement>: NDEFault stops the current measurement and changes to the specified measurement. It does not change the settings to the defaults. It does not initiate the taking of measurement data unless INIT:CONTInuous is ON.

The CONFigure? query returns the current measurement name.

The CONFigure:CATalog? query returns a quoted string of all licensed measurement names in the current mode. For example, "SAN, CHP, OBW, ACP, PST, TXP, SPUR, SEM, LIST".

Fetch Commands:

:FETCh:<measurement>[n]?

This command puts selected data from the most recent measurement into the output buffer. Use FETCh if you have already made a good measurement and you want to return several types of data (different [n] values, for example, both scalars and trace data) from a single measurement. FETCh saves you the time of re-making the measurement. You can only FETCh results from the measurement that is currently active, it will not change to a different measurement. An error message is reported if a measurement other than the current one is specified.

If you need to get new measurement data, use the READ command, which is equivalent to an INITiate followed by a FETCh.

The scalar measurement results will be returned if the optional [n] value is not included, or is set to 1. If the [n] value is set to a value other than 1, the selected trace data results will be returned. See each command for details of what types of scalar results or trace data results are available. The binary data formats should be used for handling large blocks of data since they are smaller and transfer faster than the ASCII format. (FORMat:DATA)

FETCh may be used to return results other than those specified with the original READ or MEASure command that you sent.

INITiate Commands:

:INITiate:<measurement>

This command is not available for measurements in all the instrument modes:

- Initiates a trigger cycle for the specified measurement, but does not output any data. You must then use the FETCh<meas> command to return data. If a measurement other than the current one is specified, the instrument will switch to that measurement and then initiate it.
 - For example, suppose you have previously initiated the ACP measurement, but now you are running the channel power measurement. If you send INIT:ACP? it will change from channel power to ACP and will initiate an ACP measurement.
 - Does not change any of the measurement settings. For example, if you have previously started the ACP measurement and you send INIT:ACP? it will initiate a new ACP measurement using the same instrument settings as the last time ACP was run.
 - If your selected measurement is currently active (in the idle state) it triggers the measurement, assuming the trigger conditions are met. Then it completes one trigger cycle. Depending upon the measurement and the number of averages, there may be multiple data acquisitions, with multiple trigger events, for one full trigger cycle. It also holds off additional commands on GPIB until the acquisition is complete.
-

READ Commands:

:READ:<measurement>[n]?

- Does not preset the measurement to the factory default settings. For example, if you have previously initiated the ACP
-

measurement and you send READ:ACP? it will initiate a new measurement using the same instrument settings.

- Initiates the measurement and puts valid data into the output buffer. If a measurement other than the current one is specified, the instrument will switch to that measurement before it initiates the measurement and returns results.
 - For example, suppose you have previously initiated the ACP measurement, but now you are running the channel power measurement. Then you send READ:ACP? It will change from channel power back to ACP and, using the previous ACP settings, will initiate the measurement and return results.
 - Blocks other SCPI communication, waiting until the measurement is complete before returning the results
 - If the optional [n] value is not included, or is set to 1, the scalar measurement results will be returned. If the [n] value is set to a value other than 1, the selected trace data results will be returned. See each command for details of what types of scalar results or trace data results are available. The binary data formats should be used when handling large blocks of data since they are smaller and faster than the ASCII format. (FORMat:DATA)
-

Initial S/W Revision	Prior to A.02.00
----------------------	------------------

Current Measurement Query (Remote Command Only)

This command returns the name of the measurement that is currently running.

Remote Command	:CONFigure?
-----------------------	-------------

Example	CONF?
----------------	-------

Initial S/W Revision	Prior to A.02.00
----------------------	------------------

Limit Test Current Results (Remote Command Only)

Queries the status of the current measurement limit testing. It returns a 0 if the measured results pass when compared with the current limits. It returns a 1 if the measured results fail any limit tests.

Remote Command	:CALCulate:CLIMits:FAIL?
-----------------------	--------------------------

Example	CALC:CLIM:FAIL? queries the current measurement to see if it fails the defined limits. Returns a 0 or 1: 0 it passes, 1 it fails.
----------------	--

Initial S/W Revision	Prior to A.02.00
----------------------	------------------

Data Query (Remote Command Only)

Returns the designated measurement data for the currently selected measurement and subopcode.

n = any valid subopcode for the current measurement. See the measurement command results table for your current measurement, for information about what data is returned for the subopcodes.

This command uses the data setting specified by the FORMat:BORDER and FORMat:DATA commands and can return real or ASCII data. (See the format command descriptions under Input/Output in the Analyzer Setup section.)

Remote Command	:CALCulate:DATA[n]?
Notes	The return trace depends on the measurement. In CALCulate:<meas>:DATA[n], n is any valid subopcode for the current measurement. It returns the same data as the FETCH:<measurement>? query where <measurement> is the current measurement.
Initial S/W Revision	Prior to A.02.00

Calculate/Compress Trace Data Query (Remote Command Only)

Returns compressed data for the currently selected measurement and sub-opcode [n].

n = any valid sub-opcode for that measurement. See the MEASure:<measurement>? command description of your specific measurement for information on the data that can be returned.

The data is returned in the current Y Axis Unit of the analyzer. The command is used with a sub-opcode <n> (default=1) to specify the trace. With trace queries, it is best if the analyzer is not sweeping during the query. Therefore, it is generally advisable to be in Single Sweep, or Update=Off.

This command is used to compress or decimate a long trace to extract and return only the desired data. A typical example would be to acquire N frames of GSM data and return the mean power of the first burst in each frame. The command can also be used to identify the best curve fit for the data.

Remote Command	:CALCulate:DATA<n>:COMPRESS? BLOCK CFIT MAXimum MINimum MEAN DMEan RMS RMSCubed SAMPLE SDEVIation PPHase [,<soffset> [,<length>[,<roffset>[,<rlimit>]]]]
Example	To query the mean power of a set of GSM bursts: Supply a signal that is a set of GSM bursts. Select the IQ Waveform measurement (in IQ Analyzer Mode). Set the sweep time to acquire at least one burst. Set the triggers such that acquisition happens at a known position relative to a burst. Then query the mean burst levels using, CALC:DATA2:COMP? MEAN, 24e-6, 526e-6 (These parameter values correspond to GSM signals, where 526e-6 is the length of the burst in the slot and you just want 1 burst.)
Notes	The command supports 5 parameters. Note that the last 4 (<soffset>, <length>, <roffset>, <rlimit>) are optional. But these optional parameters must be entered in the specified order. For example, if you want to specify <length>, then you must also specify <soffset>. See details below for a definition of each of these parameters. This command uses the data in the format specified by FORMat:DATA, returning either binary or ASCII data.
Initial S/W Revision	Prior to A.02.00

- BLOCK or block data - returns all the data points from the region of the trace data that you specify. For example, it could be used to return the data points of an input signal over several timeslots, excluding the portions of the trace data that you do not want. (This is x,y pairs for trace data and I,Q pairs for complex data.)

- CFIT or curve fit - applies curve fitting routines to the data. <soffset> and <length> are required to define the data that you want. <roffset> is an optional parameter for the desired order of the curve equation. The query will return the following values: the x-offset (in seconds) and the curve coefficients ((order + 1) values).

MIN, MAX, MEAN, DME, RMS, RMSC, SAMP, SDEV and PPH return one data value for each specified region (or <length>) of trace data, for as many regions as possible until you run out of trace data (using <roffset> to specify regions). Or they return the number of regions you specify (using <rlimit>) ignoring any data beyond that.

- MINimum - returns the minimum data point (y value) for the specified region(s) of trace data. For I/Q trace data, the minimum magnitude of the I/Q pairs is returned.
- MAXimum - returns the maximum data point (y value) for the specified region(s) of trace data. For I/Q trace data, the maximum magnitude of the I/Q pairs is returned.
- MEAN - returns a single value that is the arithmetic mean of the data point values (in dB/ dBm) for the specified region(s) of trace data. For I/Q trace data, the mean of the magnitudes of the I/Q pairs is returned. See the following equations.

-

NOTE

If the original trace data is in dB, this function returns the arithmetic mean of those log values, not log of the mean power which is a more useful value. The mean of the log is the better measurement technique when measuring CW signals in the presence of noise. The mean of the power, expressed in dB, is useful in power measurements such as Channel Power. To achieve the mean of the power, use the RMS option.

Equation 1

Mean Value of Data Points for Specified Region(s)

$$MEAN = \frac{1}{n} \sum_{X_i \in \text{region}(s)} X_i$$

where X_i is a data point value, and n is the number of data points in the specified region(s).

Equation 2

Mean Value of I/Q Data Pairs for Specified Region(s)

$$MEAN = \frac{1}{n} \sum_{X_i \in \text{region}(s)} |X_i|$$

where $|X_i|$ is the magnitude of an I/Q pair, and n is the number of I/Q pairs in the specified region(s).

- DMEan - returns a single value that is the mean power (in dB/ dBm) of the data point values for the specified region(s) of trace data. See the following equation:

Equation 3

DMEan Value of Data Points for Specified Region(s)

$$\text{DME} = 10 \times \log_{10} \left(\frac{1}{n} \sum_{X_i \in \text{region}(s)} 10^{\frac{X_i}{10}} \right)$$

- RMS - returns a single value that is the average power on a root-mean-squared voltage scale (arithmetic rms) of the data point values for the specified region(s) of trace data. See the following equation.

NOTE

For I/Q trace data, the rms of the magnitudes of the I/Q pairs is returned. See the following equation. This function is very useful for I/Q trace data. However, if the original trace data is in dB, this function returns the rms of the log values which is not usually needed.

Equation 4

RMS Value of Data Points for Specified Region(s)

$$\text{RMS} = \sqrt{\frac{1}{n} \sum_{X_i \in \text{region}(s)} X_i^2}$$

where X_i is a data point value, and n is the number of data points in the specified region(s).

Equation 5

RMS Value of I/Q Data Pairs for Specified Region(s)

$$\text{RMS} = \sqrt{\frac{1}{n} \sum_{X_i \in \text{region}(s)} X_i X_i^*}$$

where X_i is the complex value representation of an I/Q pair, X_i^* its conjugate complex number, and n is the number of I/Q pairs in the specified region(s).

Once you have the rms value for a region of trace data (linear or I/Q), you may want to calculate the mean power. You must convert this rms value (peak volts) to power in dBm:

$$10 \times \log[10 \times (\text{rms value})^2]$$

- SAMPlE - returns the first data value (x,y pair) for the specified region(s) of trace data. For I/Q trace data, the first I/Q pair is returned.
- SDEVIation - returns a single value that is the arithmetic standard deviation for the data point values for the specified region(s) of trace data. See the following equation.
- For I/Q trace data, the standard deviation of the magnitudes of the I/Q pairs is returned. See the following equation.

Equation 6

Standard Deviation of Data Point Values for Specified Region(s)

$$\text{SDEV} = \sqrt{\frac{1}{n} \sum_{X_i \in \text{region}(s)} (X_i - \bar{X})^2}$$

where X_i is a data point value, \bar{X} is the arithmetic mean of the data point values for the specified region (s), and n is the number of data points in the specified region(s).

$$\text{SDEV} = \sqrt{\frac{1}{n} \sum_{X_i \in \text{region}(s)} (|X_i| - \bar{X})^2}$$

where $|X_i|$ is the magnitude of an I/Q pair, \bar{X} is the mean of the magnitudes for the specified region(s), and n is the number of data points in the specified region(s).

- PPHase - returns the x,y pairs of both rms power (dBm) and arithmetic mean phase (radian) for every specified region and frequency offset (Hz). The number of pairs is defined by the specified number of regions. This parameter can be used for I/Q vector ($n=0$) in Waveform (time domain) measurement and all parameters are specified by data point in PPHase.

The rms power of the specified region may be expressed as:

$$\text{Power} = 10 \times \log [10 \times (\text{RMS I/Q value})] + 10.$$

The RMS I/Q value (peak volts) is:

$$\sqrt{\frac{1}{n} \sum_{X_i \in \text{region}} X_i X_i^*}$$

where X_i is the complex value representation of an I/Q pair, X_i^* its conjugate complex number, and n is the number of I/Q pairs in the specified region.

The arithmetic mean phase of the specified region may be expressed as:

$$\frac{1}{n} \sum_{Y_i \in \text{region}} Y_i$$

where Y_i is the unwrapped phase of I/Q pair with applying frequency correction and n is the number of I/Q pairs in the specified region.

The frequency correction is made by the frequency offset calculated by the arithmetic mean of every specified region's frequency offset. Each frequency offset is calculated by the least square method against the unwrapped phase of I/Q pair.

Sample Trace Data - Constant Envelope

(See below for explanation of variables.)

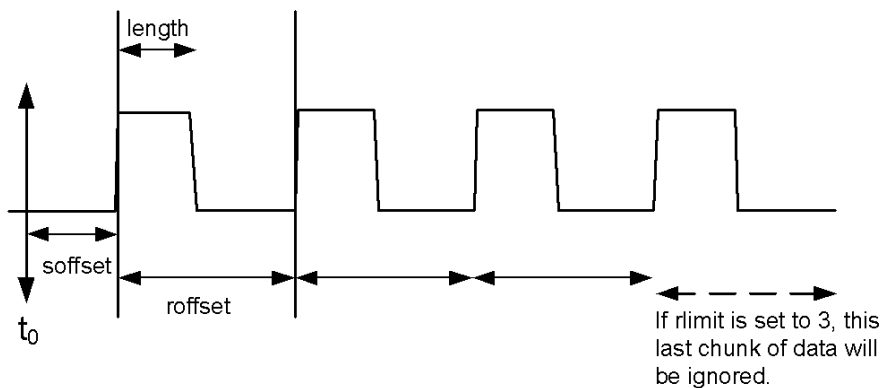

Sample Trace Data - Not Constant Envelope

(See below for explanation of variables.)

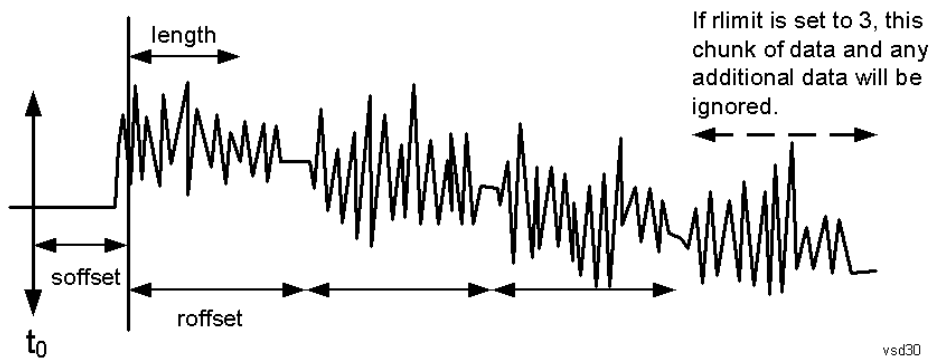

$\langle \text{soffset} \rangle$ - start offset is an optional real number. (It is in seconds for time-domain traces, and is a dimensionless index 0 to $N_{\text{points}} - 1$, for frequency-domain traces). It specifies the amount of data at the beginning of the trace that will be ignored before the decimation process starts. It is the time or frequency change from the start of the trace to the point where you want to start using the data. The default value is zero.

$\langle \text{length} \rangle$ - is an optional real number. (It is in seconds for time-domain traces, and is a dimensionless index 0 to $N_{\text{points}} - 1$, for frequency-domain traces). It defines how much data will be compressed into one value. This parameter has a default value equal to the current trace length.

$\langle \text{roffset} \rangle$ - repeat offset is an optional real number. (It is in seconds for time-domain traces, and is a dimensionless index 0 to $N_{\text{points}} - 1$, for frequency-domain traces). It defines the beginning of the next field of trace elements to be compressed. This is relative to the beginning of the previous field. This parameter has a default value equal to the $\langle \text{length} \rangle$ variable. Note that this parameter is used for a completely different purpose when curve fitting (see CFIT above).

$\langle \text{rlimit} \rangle$ - repeat limit is an optional integer. It specifies the number of data items that you want returned. It will ignore any additional items beyond that number. You can use the Start offset and the Repeat limit to pick out exactly what part of the data you want to use. The default value is all the data.

Calculate Peaks of Trace Data (Remote Command Only)

Returns a list of all the peaks for the currently selected measurement and sub-opcode [n]. The peaks must meet the requirements of the peak threshold and excursion values.

n = any valid sub-opcode for the current measurement. See the MEASure:<measurement> command description of your specific measurement for information on the data that can be returned.

The command can only be used with specific sub-opcodes with measurement results that are trace data. Both real and complex traces can be searched, but complex traces are converted to magnitude in dBm. In many measurements the sub-opcode n=0, is the raw trace data which cannot be searched for peaks. And Sub-opcode n=1, is often calculated results values which also cannot be searched for peaks.

This command uses the data setting specified by the FORMat:BORDER and FORMat:DATA commands and can return real or ASCII data. If the format is set to INT,32, it returns REAL,32 data.

The command has four types of parameters:

- Threshold (in dBm)
- Excursion (in dB)
- Sorting order (amplitude, frequency, time)
- Optional in some measurements: Display line use (all, > display line, < display line)

Remote Command	<p>For Swept SA measurement:</p> <pre>:CALCulate:DATA[1] 2 ... 6:PEAKs? <threshold>,<excursion>[,AMPLitude FREQuency TIME[,ALL GTDLine LTDLine]]</pre> <p>For most other measurements:</p> <pre>:CALCulate:DATA[1] 2 ... 6:PEAKs? <threshold>,<excursion>[,AMPLitude FREQuency TIME]</pre>
-----------------------	--

Example	<p>Example for Swept SA measurement in Spectrum Analyzer Mode:</p> <p>CALC:DATA4:PEAK? -40, 10, FREQ, GTDL This will identify the peaks of trace 4 that are above -40 dBm, with excursions of at least 10 dB. The peaks are returned in order of increasing frequency, starting with the lowest frequency. Only the peaks that are above the display line are returned.</p> <p>Query Results 1:</p> <p>With FORMat:DATA REAL, 32 selected, it returns a list of floating-point numbers. The first value in the list is the number of peak points that are in the following list. A peak point consists of two values: a peak amplitude followed by its corresponding frequency (or time).</p> <p>If no peaks are found the peak list will consist of only the number of peaks, (0).</p>
----------------	---

Notes	<p><n> - is the trace that will be used</p> <p><threshold> - is the level below which trace data peaks are ignored. Note that the threshold value is required and is always used as a peak criterion. To effectively disable the threshold criterion for this command, provide a substantially low threshold value such as -200 dBm. Also note that the threshold value used in this command is independent of and has no effect on the threshold value stored under the Peak Criteria menu.</p> <p><excursion> - is the minimum amplitude variation (rise and fall) required for a signal to be identified as peak. Note that the excursion value is required and is always used as a peak criterion. To effectively disable the excursion criterion for this command, provide the minimum value of 0.0 dB. Also note that the excursion value used in this command is independent of and has no effect on the</p>
--------------	---

excursion value stored under the Peak Criteria menu.

Values must be provided for threshold and excursion. The sorting and display line parameters are optional (defaults are AMPLitude and ALL).

Note that there is always a Y-axis value for the display line, regardless of whether the display line state is on or off. It is the current Y-axis value of the display line which is used by this command to determine whether a peak should be reported. Sorting order:

AMPLitude - lists the peaks in order of descending amplitude, with the highest peak first (default if optional parameter not sent)

FREQUENCY - lists the peaks in order of occurrence, left to right across the x-axis.

TIME - lists the peaks in order of occurrence, left to right across the x-axis.

Peaks vs. Display Line:

ALL - lists all of the peaks found (default if optional parameter not sent).

GTDLine (greater than display line) - lists all of the peaks found above the display line.

LTDLine (less than display line) - lists all of the peaks found below the display line.

Initial S/W Revision	Prior to A.02.00
----------------------	------------------

Hardware-Accelerated Fast Power Measurement (Remote Command Only)

The Fast Power option (FP2) enables very fast channel power measurements for instruments with the prerequisite hardware (DP2 and/or B40). It accomplishes this by performing real-time overlapped FFTs at the hardware layer, using software for basic post-processing before returning the result to the user. The upshot of this approach is improved throughput for user applications that require many sequential power measurements.

The analysis bandwidth of FP2 is limited by the licenses in the instrument, but its maximum overall analysis bandwidth per acquisition is 40 MHz.

FP2 is remote-only, which means the instrument does not switch to any particular mode or measurement. FP2 commands can be sent while another application is in use on the front panel.

Each Fast Power measurement can be predefined using an array index, and up to 1,000 measurements can be stored. In the following documentation, instances of [1,2,...,999] can be substituted with a particular measurement index, e.g. CALC:FPOW:POW1?, CALC:FPOW:POW2?, CALC:FPOW:POW134?. In this way, power measurements can be defined one time in a batch, and then executed multiple times without having to redefine them, similar to “list mode” on other measurements.

In addition to basic channel power measurements, there are a number of other measurement “functions” for each channel, including peak power, peak frequency, and power spectral density. See the Function parameter for more information.

Reset Fast Power Measurement (Remote Command Only)

Resets the measurement configuration to the defaults.

Mode	All
Remote Command	:CALCulate:FPOWer:POWer[1,2,...,999]:RESet
Example	:CALC:FPOW:POW1:RES

Notes	Option FP2 is required.
Initial S/W Revision	A.14.00

Define Fast Power Measurement (Remote Command Only)

Fast Power acquisitions are configured using the DEFine command. This command accepts a comma-delimited string of configuration parameters and their appropriate values, which are all specified in the subsection below.

Mode	All
Remote Command	:CALCulate:FPOWER:POWer[1,2,...,999]:DEFine "configuration string"
Example	:CALC:FPOW:POW1:DEF "CenterFrequency=2e9, AcquisitionTime=0.005"
Notes	See below for a list of measurement variables that can be defined in the configuration string.
Initial S/W Revision	A.14.00

Acquisition Time

Example	CALC:FPOW:POW1:DEF "AcquisitionTime=0.002"
Notes	The acquisition time parameter sets the time in which the entire spectrum is measured. An increase in the acquisition time yields an improvement in measurement repeatability.
Preset	0.001 s
Range	0 s to 1 s
Default Unit	Time (s)
Initial S/W Revision	A.14.00

Center Frequency

Example	CALC:FPOW:POW1:DEF "CenterFrequency=2e9"
Notes	The center frequency parameter sets the frequency in which the measurement is centered around. The OffsetFrequency parameter is calculated relative to the center frequency.
Preset	1 GHz
Range	0 Hz to maximum instrument frequency
Default Unit	Frequency (Hz)
Initial S/W Revision	A.14.00

DC Coupled

Example	CALC:FPOW:POW1:DEF "DCCoupled=True"
Notes	The DC coupled parameter allows the user to specify whether the DC blocking capacitor is utilized. Set parameter to true when measuring frequencies below 10 MHz.
Preset	False
Range	True (DC Coupled) or False (AC Coupled)
Default Unit	Boolean
Initial S/W Revision	A.14.00

DetectorType

Example	CALC:FPOW:POW1:DEF "DetectorType=Peak"
Notes	Option FP2 is required. The detector type parameter allows the user to choose whether a RMS average or peak value is used during the measurement.
Preset	RmsAverage
Range	RmsAverage, Peak
Initial S/W Revision	A.14.00

Do Noise Correction

Example	CALC:FPOW:POW1:DEF "DoNoiseCorrection=True"
Notes	When noise correction is enabled, the linear noise power contributed by the analyzer is subtracted from all measurements. This effectively lowers the noise floor of the analyzer. When noise correction is enabled, the first measurement for a given set of input parameters will take extra time. This is because the analyzer takes an extra acquisition with the RF input disconnected from the analyzer's front end to measure the noise of just the analyzer. The measured noise floor is stored in a cache so the noise acquisition will occur only once for the same state settings. In other words, if noise correction was turned on and the analyzer made an acquisition at frequency A, then frequency B, and back again to frequency A, the hidden initial noise floor acquisition would only occur for the first acquisition at frequency A and the cached noise floor would be used the second time frequency A was measured.
Preset	False
Range	True (enable noise correction) or False (disable noise correction)
Default Unit	Boolean
Initial S/W Revision	A.14.00

Do Spur Suppression

Example	CALC:FPOW:POW1:DEF "DoSpurSuppression=True"
Notes	<p>When measuring very low level signals, or when large out-of-band inputs are input into the analyzer, sometimes unwanted spurs and residuals can appear in the measured spectrum. Spur suppression is a method to help minimize the levels of these internally generated spurs and residuals.</p> <p>When spur suppression is enabled, the analyzer will automatically take two acquisitions using two different internal analog LO frequencies. The FFT spectrums from both acquisitions are combined by taking the minimum power between both traces on a per FFT bin basis. External signals will have the same amplitude for both traces and therefore will return the expected amplitudes. However, low level spurs and residuals generated internally to the analyzer tend to move to different FFT bins depending on the internal analog LO frequency used, and therefore tend to be suppressed using this spur suppression method.</p> <p>Because two acquisitions, rather than a single acquisition, are made when spur suppression is enabled, the measurement time will always be slower when spur suppression is enabled.</p>
Preset	False
Range	True (enable spur suppression) or False (disable spur suppression)
Default Unit	Boolean
Initial S/W Revision	A.14.00

Electronic Attenuator Bypass

Example	CALC:FPOW:POW1:DEF "ElecAttBypass =False"
Notes	The electronic attenuation bypass parameter allows the user to either utilize or bypass the electronic attenuator. The electronic attenuator is only available for frequencies up to 3.6 GHz. Set parameter to true when using frequencies above 3.6 GHz and set the parameter to false when using the preamp.
Preset	True
Range	True (bypass electronic attenuator) or False (use electronic attenuator)
Default Unit	Boolean
Initial S/W Revision	A.14.00

Electronic Attenuation

Example	CALC:FPOW:POW1:DEF "ElecAttenuation=10"
Notes	<p>Option EA3 is required.</p> <p>The electronic attenuation value parameter sets the amount of electrical attenuation from 0 to 24 dB (1 dB steps).</p> <p>Set "ElecAttBypass=False" to make sure the electronic attenuator path is enabled.</p>
Preset	0 dB
Range	0 – 24 dB (1 dB steps)

Default Unit	dB
Initial S/W Revision	A.14.00

IF Gain

Example	CALC:FPOW:POW1:DEF "IFGain=10"
Notes	The IF gain parameter allows the user to specify the gain at the IF stage anywhere from -6 to 16 dB (1 dB steps). This is an advanced feature, and for most cases this should remain at its default value of 0 dB.
Preset	0 dB
Range	-6 - 16 dB (1 dB steps)
Default Unit	dB
Initial S/W Revision	A.14.00

IF Type

Example	CALC:FPOW:POW1:DEF "IFType=B25M"
Notes	The IF type parameter allows the user to select between different IF paths. For example, if the signal is less than 25 MHz wide, then the user can select the B25M path to take advantage of additional filtering on this analog IF path.
Preset	B40M
Range	B10M, B25M, B40M
Initial S/W Revision	A.14.00

Include Power Spectrum

Example	CALC:FPOW:POW1:DEF "IncludePowerSpectrum=True"
Notes	The power spectrum parameter allows the user to read data on the entire spectrum for diagnostic purposes. It is not recommended for production use. See CALC:FPOW:POW[n]:READ2? for details on the binary format of the response.
Preset	False
Range	True (return both channel power and full power spectrum) or False (returns only channel power)
Default Unit	Boolean
Initial S/W Revision	A.14.00

Mechanical Attenuation

Example	CALC:FPOW:POW1:DEF "MechAttenuation=10"
Notes	The mechanical attenuation value parameter sets the amount of mechanical attenuation anywhere from 0 to 70 dB (2 dB steps).
Preset	0 dB
Range	0 – 70 dB (2 dB steps)
Default Unit	dB
Initial S/W Revision	A.14.00

Preamp Mode

Example	CALC:FPOW:POW1:DEF "PreAmpMode=Low"
Notes	The license for the appropriate preamp is required. The preamp mode parameter specifies whether the preamps are being utilized. Low allows any preamps up to 3.6 GHz, and Full allows all licensed preamps. Set "ElecAttBypass=True" in order to utilize any preamps.
Preset	Off
Range	Off, Low, Full
Initial S/W Revision	A.14.00

Resolution Bandwidth Mode

Example	CALC:FPOW:POW1:DEF "PreAmpMode=Low"
Notes	The resolution bandwidth mode parameter allows the user to choose whether the RBW filter is automatically or manually set. The BestSpeed value minimizes measurement time, while the Narrowest value minimizes RBW size (minimum of two FFT bins per RBW). To manually specify an RBW, set this parameter to Explicit, and set the ResolutionBW parameter to the desired value.
Preset	BestSpeed
Range	BestSpeed, Narrowest, Explicit
Initial S/W Revision	A.14.00

Resolution Bandwidth

Example	CALC:FPOW:POW1:DEF "ResolutionBW=25e3"
Notes	The resolution bandwidth parameter sets the 3-dB bandwidth of the RBW filter. The ResolutionBWMode parameter must be set to Explicit in order to manually set the RBW.

Preset	0 Hz
Default Unit	Hz
Initial S/W Revision	A.14.00

Trigger Delay

Example	CALC:FPOW:POW1:DEF "TriggerDelay=0.025"
Notes	The trigger delay parameter sets the time after an external trigger is detected until the measurement is performed.
Preset	0 s
Range	0 – 1 s
Default Unit	Seconds
Initial S/W Revision	A.14.00

Trigger Level

Example	CALC:FPOW:POW1:DEF "TriggerLevel=2"
Notes	The trigger level parameter sets the voltage value at which an external trigger is detected.
Preset	1.2 V
Range	-5 to 5 V
Default Unit	Volts
Initial S/W Revision	A.14.00

Trigger Slope

Example	CALC:FPOW:POW1:DEF "TriggerSlope=Negative"
Notes	The trigger slope parameter indicates the direction of the edge trigger voltage for detection.
Preset	Positive
Range	Positive, Negative
Initial S/W Revision	A.14.00

Trigger Source

Example	CALC:FPOW:POW1:DEF "TriggerSource=Ext1"
Notes	The trigger source parameter allows the user to choose between measurement's triggering freely or controlled by an external input. Ext1 and Ext2 correspond to Trigger 1 In and Trigger 2 In, respectively.
Preset	Free
Range	Free, Ext1, Ext2
Initial S/W Revision	A.14.00

Trigger Timeout

Example	CALC:FPOW:POW1:DEF "TriggerTimeout=0.1"
Notes	The trigger timeout parameter sets the time in which the analyzer will wait for a trigger before automatically performing the measurement.
Preset	1 s
Range	0 - 1 s
Default Unit	Seconds
Initial S/W Revision	A.14.00

Signal Input

Example	CALC:FPOW:POW1:DEF "SignalInput=Fp50MHzCW"
Notes	The signal input parameter allows the user to select between using the main RF input or the internal analyzer reference CW signal of 50 MHz.
Preset	FpMainRf
Range	FpMainRf, Fp50MHzCW
Initial S/W Revision	A.14.00

Use Preselector

Example	CALC:FPOW:POW1:DEF "UsePreSelector=True"
Notes	The preselector parameter allows the user to either utilize or bypass the front end tunable filter at frequencies above 3.6 GHz. For frequencies below 3.6 GHz, the preselector is automatically bypassed, so you do not need to set this parameter to False in those cases.
Preset	False
Range	True (use preselector above 3.6 GHz), or False (preselector bypassed)

Default Unit	Boolean
Initial S/W Revision	A.14.00

Channel Bandwidth Array

Example	CALC:FPOW:POW1:DEF "Bandwidth=[3.84e6, 5e6, 3.84e6]"
Notes	The bandwidth parameter array defines the bandwidth of each channel that will be measured. All array parameters should have the same number of elements. Alternatively, if all the elements are the same value, a single number with no square brackets can be used to define the parameter.
Preset	[1 e6]
Range	0 to 40 MHz
Default Unit	Hz
Initial S/W Revision	A.14.00

Channel Filter Type Array

Example	CALC:FPOW:POW1:DEF "FilterType=[RRC, IBW, RRC]"
Notes	The filter type parameter allows the user to choose between an integration bandwidth (IBW) filter or a root-raised-cosine (RRC) filter. The integration bandwidth filter weighs all frequencies within the bandwidth equally. The root-raised-cosine filter has an associated shape parameter, defined by the FilterAlpha parameter. All array parameters should have the same number of elements. Alternatively, if all the elements are the same value, a single value with no square brackets can be used to define the parameter.
Preset	[IBW]
Range	IBW, RRC
Initial S/W Revision	A.14.00

Channel Filter Alpha Array

Example	CALC:FPOW:POW1:DEF "FilterAlpha=[0.5, 0.0, 0.5]"
Notes	The filter alpha parameter allows the user to adjust the alpha value associated with the root-raised-cosine (RRC) filter type. Set FilterType to RRC in order to utilize this parameter. All array parameters should have the same number of elements. Alternatively, if all the elements are the same value, a single number with no square brackets can be used to define the parameter.
Preset	[0.22]
Range	0.0 - 1.0

Initial S/W Revision	A.14.00
-------------------------	---------

Channel Measurement Function Array

Example	CALC:FPOW:POW1:DEF "Function=[BandPower, PeakPower, BandPower]"
Notes	<p>This parameter array defines what measurement is being made for each individually-specified channel:</p> <p>BandPower: Total power within the specified bandwidth of the channel (dBm)</p> <p>BandDensity: Total power density within the specified bandwidth of the channel (dBm/Hz)</p> <p>PeakPower: The peak power value within the specified bandwidth of the channel (dBm)</p> <p>PeakFrequency: The frequency which corresponds to the peak power value within the specified bandwidth of the channel. This frequency is relative to the center frequency (Hz)</p> <p>XdBBandwidth: The half power (-3.01 dB) bandwidth of the highest amplitude signal that resides within the channel (Hz), dB is configurable using XdBBandwidth parameter</p> <p>OccupiedBandwidth: The bandwidth at which 99% of the total power resides within the channel (Hz), percentage configurable using OccupiedBandwidthPercent parameter</p> <p>All array parameters should have the same number of elements. Alternatively, if all the elements are the same value, a single value with no square brackets can be used to define the parameter.</p>
Preset	[BandPower]
Range	BandPower, BandDensity, PeakPower, PeakFrequency, XdBBandwidth, OccupiedBandwidth
Initial S/W Revision	A.14.00

Channel Offset Frequency Array

Example	CALC:FPOW:POW1:DEF "OffsetFrequency=[-5e6, 0, 5e6]"
Notes	<p>The offset frequency parameter array defines the difference between the center frequency to the center frequency of each channel.</p> <p>All array parameters should have the same number of elements.</p>
Preset	[0]
Range	0 to 20 MHz
Default Unit	Hz
Initial S/W Revision	A.14.00

Channel Occupied Bandwidth Percent Array

Example	CALC:FPOW:POW1:DEF "OccupiedBandwidthPercent =[0.95, 0.95, 0.95]"
Notes	This parameter only applies for channels whose Function is set to OccupiedBandwidth. The occupied

	bandwidth percent parameter specifies the percent of total power in these channels. The valid range for this parameter is 0.0 to 1.0, where 1.0 represents 100%. The default for this parameter is 0.99, which will return the bandwidth that contains 99% of the total channel power.
Preset	[0.99]
Range	0 – 1.0
Initial S/W Revision	A.14.00

Channel x-dB Bandwidth Array

Example	CALC:FPOW:POW1:DEF " XdBBandwidth =[-6.02, -3.01, -1.0]"
Notes	This parameter only applies for channels whose Function is set to XdBBandwidth. The X dB bandwidth parameter is used to specify the power relative to the peak channel power over which the bandwidth is calculated. The parameter value must be a negative number.
Preset	[-3.01]
Range	-200 to 0 dB
Default Unit	dB
Initial S/W Revision	A.14.00

Define Fast Power Measurement Query (Remote Command Only)

The DEFine? command is used to retrieve a list of all defined parameters in an ASCII string format

```

M All
o
d
e
R :CALCulate:FPOWER:POWer [1,2,...,999]:DEFine?
e
m
o
t
e
C
o
m
m
a
n
d
E :CALC:FPOW:POW1:DEF?

```

```
x
a
m
p
l
e
N This command query is used to retrieve a list of all defined parameters in an ASCII format.
o The following is an example of the returned results:
t "DCCoupled=False,ElecAttBypass=True,ElecAttenuation=0,IFGain=0,MechAttenuation=0,PreAmpMode=Off,PreSelectorOffset
e =0,UsePreSelector=False,ExternalReferenceFrequency=10000000,FrequencyReferenceSource=AutoExternalFrequencyRefer
s ence,IFType=B40M,LOMode=SLW,SignalInput=FpMainRf,AcquisitionTime=0.001,CenterFrequency=1000000000,Resolution
BW=0,ResolutionBWMode=BestSpeed,DetectorType=RmsAverage,Bandwidth=[1000000],OffsetFrequency=[0],Function=
[BandPower],FilterType=[IBW],FilterAlpha=[0.22],OccupiedBandwidthPercent=[0.99],XdBBandwidth=[-
3.01],DoNoiseCorrection=False,DoSpurSuppression=False,MeasurementMethod=HardwareFFT,IncludePowerSpectrum=False,
e,TriggerDelay=0,TriggerLevel=1.2,TriggerSlope=Positive,TriggerSource=Free,TriggerTimeout=1 "
I A.14.00
n
i
t
i
a
l
S
/
W
R
e
v
i
s
i
o
n
```

Configure Fast Power Measurement (Remote Command Only)

The configure command begins hardware setup and returns immediately, with no acquisition made. This can be used in parallel with other hardware operations to effectively hide the hardware setup time.

Mode	All
Remote Command	:CALCulate:FPOWer:POWer[1,2,...,999]:CONFigure
Example	:CALC:FPOW:POW1:CONF
Notes	Option FP2 is required.
Initial S/W Revision	A.14.00

Initiate Fast Power Measurement (Remote Command Only)

The INITiate command begins an acquisition and returns immediately. The results of the measurement can be retrieved using FETCh.

Mode	All
Remote Command	:CALCulate:FPOWER:POWER[1,2,...,999]:INITiate
Example	:CALC:FPOW:POW1:INIT
Notes	Option FP2 is required.
Initial S/W Revision	A.14.00

Fetch Fast Power Measurement (Remote Command Only)

The FETCh command query is used to retrieve the results of an acquisition initiated by the INIT command. The returned results are in ASCII string format. The string begins and ends with quotation marks.

Mode	All
Remote Command	:CALCulate:FPOWER:POWER[1,2,...,999]:FETCh?
Example	:CALC:FPOW:POW1:FETC?
Notes	Option FP2 is required. Returns m comma-separated ASCII values, where m corresponds to the number of bandwidths defined. 1. Declared function return in the 1st specified channel 2. Declared function return in the 2nd specified channel ... m. Declared function return in the last specified channel The INIT and FETC? command sequence performs the same functionality of a single CALC:FPOW:POW[n]? query. Units of the returned values are dependent on the Function parameter for each channel.
Initial S/W Revision	A.14.00

Execute Fast Power Measurement (Remote Command Only)

This command query is used as shorthand for an INIT command immediately followed by a FETC? command. The returned results are in ASCII string format. The string begins and ends with quotation marks.

Mode	All
Remote Command	:CALCulate:FPOWER:POWER[1,2,...,999]?
Example	:CALC:FPOW:POW1?

Notes	Option FP2 is required. See notes for Fast Power Fetch for return format.
Initial S/W Revision	A.14.00

Binary Read Fast Power Measurement (Remote Command Only)

This command query is used as shorthand for an INIT command immediately followed by a FETC? command. The returned results are in a binary format.

Mode	All
Remote Command	:CALCulate:FPOWER:POWER[1,2,...,999]:READ? :CALCulate:FPOWER:POWER[1,2,...,999]:READ1?
Example	:CALC:FPOW:POW1:READ? :CALC:FPOW:POW1:READ1?
Notes	Option FP2 is required. Returns m 4 byte floating point binary values (Little-Endian), where m corresponds to the number of bandwidths defined.
Initial S/W Revision	A.14.00

Diagnostic Binary Read Fast Power Measurement (Remote Command Only)

This command query is used as shorthand for an INIT command immediately followed by a FETC? command. The returned results are in a binary format. This command is used primarily for diagnostic purposes to test for ADC overloads and to visibly inspect the spectrum.

Mode	All
Remote Command	:CALCulate:FPOWER:POWER[1,2,...,999]:READ2?
Example	:CALC:FPOW:POW1:READ2?
Notes	Option FP2 is required. Note: Spectrum data is only returned if the IncludePowerSpectrum parameter is set to True. If IncludePowerSpectrum is False, the number of spectrum points will be zero (0). Units of the returned values are dependent on the Function parameter per channel (e.g. dBm for BandPower, Hz for PeakFrequency). Returns binary data (Little-Endian) that contains information on m amount of channels, along with ADC over range and full spectrum data. The following is the binary format of the response. Bandwidth Return Value 1. Number of channels specified, m [4 byte int] 2. Declared function result for the 1st specified channel [4 byte float]

	3. Declared function result for the 2nd specified channel [4 byte float]
	...
	(m + 1). Declared function result for the last (mth) specified channel [4 byte float]
	ADC Over Range
	1. ADC over-range occurred (1: true, 0: false) [2 byte short]
	Spectrum Data
	1. Number of points in the spectrum data, k [4 byte int]
	2. Start frequency of spectrum data (Hz) [8 byte double]
	3. Step frequency of spectrum data (Hz) [8 byte double]
	4. FFT bin at 1st point (dBm) [4 byte float]
	5. FFT bin at 2nd point (dBm) [4 byte float]
	...
	(k + 3). FFT bin at last (kth) point (dBm) [4 byte float]

Initial S/W Revision	A.14.00
-------------------------	---------

Format Data: Numeric Data (Remote Command Only)

This command specifies the format of the trace data input and output. It specifies the formats used for trace data during data transfer across any remote port. It affects only the data format for setting and querying trace data for the :TRACe[:DATA], TRACe[:DATA]?, :CALCulate:DATA[n]? and FETCh:SANalyzer [n]? commands and queries.

Remote Command	:FORMat[:TRACe][:DATA] ASCii INTEger,32 REAL,32 REAL,64 :FORMat[:TRACe][:DATA]?
Notes	The query response is: ASCii: ASC,8 REAL,32: REAL,32 REAL,64: REAL,64 INTEger,32: INT,32 When the numeric data format is REAL or ASCii, data is output in the current Y Axis unit. When the data format is INTEger, data is output in units of m dBm (.001 dBm). The INT,32 format returns binary 32-bit integer values in internal units (m dBm), in a definite length block.
Dependencies	Sending a data format spec with an invalid number (for example, INT,48) generates no error. The analyzer simply uses the default (8 for ASCii, 32 for INTEger, 32 for REAL). Sending data to the analyzer which does not conform to the current FORMat specified, results in an error. Sending ASCII data when a definite block is expected generates message -161 "Invalid Block Data" and sending a definite block when ASCII data is expected generates message -121 "Invalid Character in Number".
Preset	ASCii
Backwards Compatibility	Note that the INT,32 format is only applicable to the command, TRACe:DATA. This preserves

Notes	backwards compatibility for the Swept SA measurement. For all other commands/queries which honor FORMat:DATA, if INT,32 is sent the analyzer will behave as though it were set to REAL,32.
Initial S/W Revision	Prior to A.02.00

The specs for each output type follow:

ASCIi - Amplitude values are in ASCII, in the current Y Axis Unit, one ASCII character per digit, values separated by commas, each value in the form:

SX.YYYYYEsZZ

Where:

S = sign (+ or -)

X = one digit to left of decimal point

Y = 5 digits to right of decimal point

E = E, exponent header

s = sign of exponent (+ or -)

ZZ = two digit exponent

REAL,32 - Binary 32-bit real values in the current Y Axis Unit, in a definite length block.

REAL,64 - Binary 64-bit real values in the current Y Axis Unit, in a definite length block.

Format Data: Byte Order (Remote Command Only)

This command selects the binary data byte order for data transfer and other queries. It controls whether binary data is transferred in normal or swapped mode. This command affects only the byte order for setting and querying trace data for the :TRACe[:DATA], TRACe[:DATA]? , :CALCulate:DATA[n]? and FETCh:SANalyzer[n]? commands and queries.

By definition any command that says it uses FORMat:DATA uses any format supported by FORMat:DATA.

The NORMal order is a byte sequence that begins with the most significant byte (MSB) first, and ends with the least significant byte (LSB) last in the sequence: 1|2|3|4. SWAPped order is when the byte sequence begins with the LSB first, and ends with the MSB last in the sequence: 4|3|2|1.

Remote Command	:FORMat:BORDer NORMal SWAPped :FORMat:BORDer?
Preset	NORMal
Initial S/W Revision	Prior to A.02.00

Meas Setup

Displays the setup menu for the currently selected measurement either BTS or MS.

Key Path	Front-panel key
Initial S/W Revision	Prior to A.02.00

Meas Type

Sets the code domain power computation type to either the absolute power or the relative value to the mean power.

Key Path	Meas Setup
Mode	CDMA2K
Remote Command	:CALCulate:CDPower:TYPE RELative ABSolute :CALCulate:CDPower:TYPE?
Example	CALC:CDP:TYPE REL CALC:CDP:TYPE?
Preset	RELative
State Saved	Saved in instrument state.
Range	Abs Rel
Initial S/W Revision	Prior to A.02.00

Walsh Code Length

Sets spread code length.

Key Path	Meas Setup
Mode	CDMA2K
Remote Command	CALCulate:CDPower:WCODE:LENGth <integer> CALCulate:CDPower:WCODE:LENGth?
Example	CALCulate:CDPower:WCODE:LENGth 64 CALCulate:CDPower:WCODE:LENGth?
Notes	Walsh Code Length allows you to change Code Layer and Code Number of the code you select. It is equivalent with Spread Factor (SF). The Default value, Min value and Max value depend on radio device. For BTS, default = 64, max =128, min= 4 For Ms, default = 32, max = 32, min = 2
Remote Command Notes	You must be in the CDMA2000 mode to use this command. Use INSTRument:SElect to set the

	mode.
Couplings	Walsh Code Length must be power of 2. If the input is not equal to the power of 2, it is clipped to the nearest value available.
Preset	64 32
State Saved	Saved in instrument state.
Min	4 2
Max	128 32
Initial S/W Revision	Prior to A.02.00

Walsh Code Number

Specifies the Walsh code number.

Key Path	Meas Setup
Mode	CDMA2K
Remote Command	CALCulate:CDPower:WCODE[:NUMBER] <integer> CALCulate:CDPower:WCODE[:NUMBER]?
Example	CALCulate:CDPower:WCODE 1 CALCulate:CDPower:WCODE?
Notes	Set the Walsh code number depending on the channel type.
Remote Command Notes	You must be in the CDMA2000 mode to use this command.
Couplings	Walsh Code Number must be smaller than Walsh Code Length
Preset	0
State Saved	Saved in instrument state.
Min	0
Max	Walsh Code Length - 1
Initial S/W Revision	Prior to A.02.00

Meas Interval

Sets the length of the measurement interval in PCG (power control group), 1 PCG = 1536chips.

Key Path	Meas Setup
Mode	CDMA2K
Remote Command	:CALCulate:CDPower:SWEp:TIME <integer> :CALCulate:CDPower:SWEp:TIME?
Example	CALC:CDP:SWE:TIME 2 CALC:CDP:SWE:TIME?
Notes	Set the length of the measurement interval that is used. If summation of Meas Interval and Meas

	Offset exceeds 32 after changing Meas Interval (or Meas Offset), then Meas Offset (or Meas Interval) decreases automatically to make the summation 32.
Couplings	Max value is dependent on Capture Interval and Meas Offset
Preset	1
State Saved	Saved in instrument state.
Min	1
Max	Capture Interval
Initial S/W Revision	Prior to A.02.00

Meas Offset

Sets the timing offset of measurement interval in PCG (power control group), 1 PCG = 1536chips

Key Path	Meas Setup
Mode	CDMA2K
Remote Command	:CALCulate:CDPower:SWEep:OFFSet <integer> :CALCulate:CDPower:SWEep:OFFSet?
Example	CALC:CDP:SWE:OFFS 2 CALC:CDP:SWE:OFFS?
Notes	If summation of Meas Interval and Meas Offset exceeds 32 after changing Meas Interval (or Meas Offset), then Meas Offset (or Meas Interval) decreases automatically to make the summation 32.
Couplings	Max value is dependent [:SENSe]:CDPwer:CAPTure:TIME and CALCulate:CDPower:SWEep:TIME
Preset	0
State Saved	Saved in instrument state.
Min	0
Max	Capture Interval - 1
Initial S/W Revision	Prior to A.02.00

PN Offset

Key Path	Meas Setup, More
Remote Command	:CALCulate:CDPower:PNOffset <integer> :CALCulate:CDPower:PNOffset?
Example	CALC:CDP:PNOF 5 CALC:CDP:PNOF?
Notes	Sets value for the pseudo-random noise offset. Different pseudo-random noise offsets are used for different base stations. By setting the pseudo-random noise offset to the value that your specific base station is set to, you get the correct time offset value displayed and returned back to you when you query READ:CDPower?. The instrument, by default, assumes an offset of 0. So, if you do not use this

	command, you have to manually calculate the time offset when the value is other than 0.
Remote Command Notes	You must be in CDMA2000 mode to use this command.
Preset	0
State Saved	Saved in instrument state.
Min	0
Max	511
Initial S/W Revision	Prior to A.02.00

Sync Type(BTS only)

Opens a menu that enables you to set the channel type to be used for synchronization.

Key Path	Meas Setup
Mode	CDMA2K
Remote Command	[:SENSe] :CDPower:SYNC [:BTS] PICH DPICH [:SENSe] :CDPower:SYNC [:BTS] ?
Example	CDP:SYNC DPIC CDP:SYNC?
Notes	This command is effective when [:SENSe]:RADio:DEvIce is set to BTS.
Preset	PICH
State Saved	Saved in instrument state.
Range	F-PICH TxDiv F-PICH
Initial S/W Revision	Prior to A.02.00

Capture Interval

Sets the data capture length in PCG (1PCG = 1.25 ms) that is used in the acquisition.

Key Path	Meas Setup
Mode	CDMA2K
Remote Command	[:SENSe] :CDPower:CAPTure:TIME <integer> [:SENSe] :CDPower:CAPTure:TIME?
Example	CDP:CAPT:TIME 32 CDP:CAPT:TIME?
Remote Command Notes	You must be in CDMA2000 to use this command
Preset	5
State Saved	Saved in instrument state.
Min	2

Max	32
Initial S/W Revision	Prior to A.02.00

Spectrum Inversion

Toggles the spectrum function between Normal and Invert.

Invert : This function conjugates the spectrum, which is equivalent to taking the negative of the quadrature component in demodulation. The correct setting (Normal or Invert) depends on whether the signal at the input of the instrument has a high or low side mix.

Key Path	Meas Setup
Mode	CDMA2K
Remote Command	<code>[:SENSe] :CDPower :SPECTrum INVert NORMal</code> <code>[:SENSe] :CDPower :SPECTrum?</code>
Example	CDP:SPEC INV CDP:SPEC?
Preset	NORMal
State Saved	Saved in instrument state.
Range	Normal Invert
Initial S/W Revision	Prior to A.02.00

Meas Preset

Restores all the measurement parameters to their default values.

Key Path	Meas Setup
Mode	CDMA2K
Remote Command	<code>:CONFigure:CDPower</code>
Example	CONF:CDP
Couplings	Selecting Restore Measurement Defaults restores all measurement parameters to their default values.
Initial S/W Revision	Prior to A.02.00

Advanced

Accesses a menu of functions that enable you to set up more specific parameters for the measurement.

Key Path	Meas Setup
Initial S/W Revision	Prior to A.02.00

Active Threshold

Toggles the active channel identification function between Auto and Man. If set to Auto, the active channels are determined automatically by the internal algorithm. If set to Man, the active channel identification is determined by a user definable threshold ranging from 0.00 to -100.00 dB.

Key Path	Meas Setup
Mode	CDMA2K
Remote Command	:CALCulate:CDPower:ASET:THReshold <real> :CALCulate:CDPower:ASET:THReshold? :CALCulate:CDPower:ASET:THReshold:AUTO OFF ON 0 1 :CALCulate:CDPower:ASET:THReshold:AUTO?
Example	CALC:CDP:ASET:THR -50.0 CALC:CDP:ASET:THR? CALC:CDP:ASET:THR:AUTO ON CALC:CDP:ASET:THR:AUTO?
Preset	0.0 ON
State Saved	Saved in instrument state.
Min	-100.0
Max	0.0
Initial S/W Revision	Prior to A.02.00

Filter Alpha

Specifies the alpha value of the RX filter.

Key Path	Meas Setup, Advanced
Mode	CDMA2K
Remote Command	[[:SENSe]:CDPower:ALPHa <real> [:SENSe]:CDPower:ALPHa?
Example	CDP:ALPH 0.2 CDP:ALPH?
Preset	0.15
State Saved	Saved in instrument state.

Min	0.05
Max	0.20
Initial S/W Revision	Prior to A.02.00

Chip Rate

Allows you to Changes the chip rate.

Key Path	Meas Setup, Advanced
Mode	CDMA2K
Remote Command	[:SENSe] :CDPower:CRATe <freq> [:SENSe] :CDPower:CRATe?
Example	CDP:CRAT 1228800 CDP:CRAT?
Preset	1.2288 MHz
State Saved	Saved in instrument state.
Min	1.105920 MHz
Max	1.351680 MHz
Initial S/W Revision	Prior to A.02.00

Walsh Code QOF (BTS only)

Opens a menu to set the QOF number.

Key Path	Meas Setup, Advanced
Remote Command	[:SENSe] :CDPower:QOF 0 1 2 3 [:SENSe] :CDPower:QOF?
Example	CDP:QOF 2 CDP:QOF?
Notes	Choose among QOF = 0, 1, 2, or 3 for the specific Walsh Code that is selected. This key is available only on the BTS Mode. When QOF = 1,2 or 3, only Power Graph & Metrics view is available.
Couplings	Only available when [:SENSe]:RADio:DEVICE is BTS. when [:SENSe]:RADio:DEVICE is MS, This Menu is grayed out.
Preset	0
State Saved	Saved in instrument state.
Min	0
Max	3
Initial S/W Revision	Prior to A.02.00

12 Code DomainMeasurement
Mode

Mode

See "[Mode](#)" on page 162

Mode Preset

Returns the active mode to a known state.

Mode Preset does the following for the currently active mode:

- Aborts the currently running measurement.
- Brings up the default menu for the mode, with no active function.
- Sets measurement Global settings to their preset values for the active mode only.
- Activates the default measurement.
- Brings up the default menu for the mode.
- Clears the input and output buffers.
- Sets Status Byte to 0.

Mode Preset does not:

- Cause a mode switch
- Affect mode persistent settings
- Affect system settings
- See "[How-To Preset](#)" on page 1550 for more information.

Key Path	Front-panel key
Remote Command	:SYSTem:PRESet
Example	:SYST:PRES
Notes	*RST is preferred over :SYST:PRES for remote operation. *RST does a Mode Preset, as done by the :SYST:PRES command, and it sets the measurement mode to Single measurement rather than Continuous for optimal remote control throughput. Clears all pending OPC bits. The Status Byte is set to 0.
Couplings	A Mode Preset aborts the currently running measurement, activates the default measurement, and gets the mode to a consistent state with all of the default couplings set.
Backwards Compatibility Notes	In the X-Series, the legacy "Factory Preset" has been replaced with Mode Preset, which only presets the currently active mode, not the entire instrument. In the X-Series, the way to preset the entire instrument is by using System, Restore System Defaults All, which behaves essentially the same way as restore System Defaults does on ESA and PSA. There is also no "Preset Type" as there is on the PSA. There is a green Mode Preset front-panel key that does a Mode Preset and a white-with-green-letters User Preset front-panel key that does a User Preset. The old PRESet:TYPE command is ignored (without generating an error), and SYST:PRES without a parameter does a Mode Preset, which should cover most backward code compatibility issues. The settings and correction data under the Input/Output front-panel key (examples: Input Z Corr, Ext Amp Gain, etc.) are no longer part of any Mode, so they will not be preset by a Mode Preset. They are preset using Restore Input/Output Defaults, Restore System Defaults All. Note that because User Preset does a Recall State, and all of these settings are saved in State, they ARE recalled when using

	User Preset.
Initial S/W Revision	Prior to A.02.00

How-To Preset

The table below shows all possible presets, their corresponding SCPI commands and front-panel access (key paths). Instrument settings depend on the current measurement context. Some settings are local to the current measurement, some are global (common) across all the measurements in the current mode, and some are global to all the available modes. In a similar way, restoring the settings to their preset state can be done within the different contexts.

Auto Couple - is a measurement local key. It sets all Auto/Man parameter couplings in the measurement to Auto. Any Auto/Man selection that is local to other measurements in the mode will not be affected.

Meas Preset - is a measurement local key. Meas Preset resets all the variables local to the current measurement except the persistent ones.

Mode Preset - resets all the current mode's measurement local and measurement global variables except the persistent ones.

Restore Mode Defaults - resets ALL the Mode variables (and all the Meas global and Meas local variables), including the persistent ones.

Type Of Preset	SCPI Command	Front Panel Access
Auto Couple	:COUPle ALL	Auto Couple front-panel key
Meas Preset	:CONFigure:<Measurement>	Meas Setup Menu
Mode Preset	:SYSTem:PRESet	Mode Preset (green key)
Restore Mode Defaults	:INSTrument:DEFault	Mode Setup Menu
Restore All Mode Defaults	:SYSTem:DEFault MODEs	System Menu; Restore System Default Menu
*RST	*RST	not possible (Mode Preset with Single)
Restore Input/Output Defaults	:SYSTem:DEFault INPUt	System Menu; Restore System Default Menu
Restore Power On Defaults	:SYSTem:DEFault PON	System Menu; Restore System Default Menu
Restore Alignment Defaults	:SYSTem:DEFault ALIGN	System Menu; Restore System Default Menu
Restore Miscellaneous Defaults	:SYSTem:DEFault MISC	System Menu; Restore System Default Menu
Restore All System Defaults	:SYSTem:DEFault [ALL] :SYSTem:PRESet:PERsistent	System Menu; Restore System Default Menu
User Preset	:SYSTem:PRESet:USER	User Preset Menu
User Preset All Modes	:SYSTem:PRESet:USER:ALL	User Preset Menu

Power On Mode Preset	:SYSTEM:PON:TYPE MODE	System Menu
Power On User Preset	:SYSTEM:PON:TYPE USER	System Menu
Power On Last State	:SYSTEM:PON:TYPE LAST	System Menu

Mode Setup

See "[Mode Setup](#)" on page 181

Peak Search

Places the selected marker on the trace point with the maximum y-axis value for that marker's trace.

Key Path	Front panel key
Mode	CDMA2K
Remote Command	:CALCulate:CDPower:MARKer [1] 2 . . . 12:MAXimum
Example	CALC:CDP:MARK2:MAX
Initial S/W Revision	Prior to A.02.00

Next Peak

Moves the selected marker to the peak that has the next highest amplitude less than the marker's current value.

Key Path	Peak Search
Mode	CDMA2K
Remote Command	:CALCulate:CDPower:MARKer [1] 2 . . . 12:MAXimum:NEXT
Example	CALC:CDP:MARK2:MAX:NEXT
Initial S/W Revision	Prior to A.02.00

Next Pk Right

Moves the selected marker to the nearest peak right of the current marker which meets all enabled peak criteria.

Key Path	Peak Search
Mode	CDMA2K
Remote Command	:CALCulate:CDPower:MARKer [1] 2 . . . 12:MAXimum:RIGHT
Example	CALC:CDP:MARK2:MAX:RIGH
Initial S/W Revision	Prior to A.02.00

Next Pk Left

Moves the selected marker to the nearest peak left of the current marker which meets all enabled peak criteria.

Key Path	Peak Search
----------	-------------

Mode	CDMA2K
Remote Command	:CALCulate:CDPower:MARKer[1] 2 ...12:MAXimum:LEFT
Example	CALC:CDP:MARK2:MAX:LEFT
Initial S/W Revision	Prior to A.02.00

Marker Delta

Sets the control mode for the selected marker to Delta mode.

Key Path	Peak Search
Initial S/W Revision	Prior to A.02.00

Pk-Pk Search

Finds and displays the amplitude and frequency (or time, if in zero span) differences between the highest and lowest y-axis value.

Key Path	Peak Search
Mode	CDMA2K
Remote Command	:CALCulate:CDPower:MARKer[1] 2 ...12:PTPeak
Example	CALC:CDP:MARK:PTP
Notes	Turns on the Marker Δ active function.
Couplings	This key is not available (key is grayed out) when Coupled Markers is on.
Initial S/W Revision	Prior to A.02.00

Min Search

Moves the selected marker to the minimum y-axis value on the current trace.

Key Path	Peak Search
Mode	CDMA2K
Remote Command	:CALCulate:CDPower:MARKer[1] 2 ...12:MINimum
Example	CALC:CDP:MARK:MIN
Initial S/W Revision	Prior to A.02.00

Print

See "Print " on page 188

Quick Save

The Quick Save front-panel key repeats the most recent save that was performed from the Save menu, with the following exceptions:

- Register saves are not remembered as Saves for the purpose of the Quick Save function
- If the current measurement does not support the last non-register save that was performed, an informational message is generated, “File type not supported for this measurement”

Quick Save repeats the last type of qualified save (that is, a save qualified by the above criteria) in the last save directory by creating a unique filename using the Auto File Naming algorithm described below.

If Quick Save is pressed after startup and before any qualified Save has been performed, the Quick Save function performs a Screen Image save using the current settings for Screen Image saves (current theme, current directory), which then becomes the “last save” for the purpose of subsequent Quick Saves.

The Auto File Naming feature automatically generates a file name for use when saving a file. The filename consists of a prefix and suffix separated by a dot, as is standard for the Windows® file system. A default prefix exists for each of the available file types:

Type	Default Prefix	Menu
State	State_	(Save/Recall)
Trace + State	State_	(Save/Recall)
Screen	Screen_	(Save/Recall)
Amplitude Corrections	Ampcor_	(Import/Export)
Traces	Trace_	(Import/Export)
Limit Lines	LLine_	(Import/Export)
Measurement Result	MeasR_	(Import/Export)
Capture Buffer	CapBuf_	(Import/Export)

A four digit number is appended to the prefix to create a unique file name. The numbering sequence starts at 0000 within each Mode for each file type and updates incrementally to 9999, then wraps to 0000 again. It remembers where it was through a Mode Preset and when leaving and returning to the Mode. It is reset by Restore Misc Defaults and Restore System Defaults and subsequent running of the instrument application. So, for example, the first auto file name generated for State files is State_0000.state. The next is State_0001, and so forth.

One of the key features of Auto File Name is that we guarantee that the Auto File Name will never conflict with an existing file. The algorithm looks for the next available number. If it gets to 9999, then it looks for holes. If it find no holes, that is no more numbers are available, it gives an error.

For example, if when we get to State_0010.state there is already a State_0010.state file in the current directory, it advances the counter to State_0011.state to ensure that no conflict will exist (and then it verifies that State_0011.state also does not exist in the current directory and advances again if it does, and so forth).

If you enter a file name for a given file type, then the prefix becomes the filename you entered instead of the default prefix, followed by an underscore. The last four letters (the suffix) are the 4-digit number.

For example, if you save a measurement results file as “fred.csv”, then the next auto file name chosen for a measurement results save will be fred_0000.csv.

NOTE

Although 0000 is used in the example above, the number that is used is actually the current number in the Meas Results sequence, that is, the number that would have been used if you had not entered your own file name.

NOTE

If the filename you entered ends with _dddd, where d=any number, making it look just like an auto file name, then the next auto file name picks up where you left off with the suffix being dddd + 1.

Key Path	Front-panel key
Notes	No remote command for this key specifically.
Initial S/W Revision	Prior to A.02.00

Recall

The Recall menu lets you choose what you want to recall, and where you want to recall it from. Among the types of files you can recall are **States andTraces**. In addition, an Import (Data) option lets you recall a number of data types stored in CSV files (as used by Excel and other spreadsheet programs).

NOTE

In products that run multiple instances of the X-Series Application, all instances share the same register and file location where you want to recall from.

The default paths for Recall are data type dependent and are the same as for the Save key.

Key Path	Front-panel key
Notes	<p>No remote command for this key specifically, but the :MMEM:LOAD command is available for specific file types. An example is :MMEM:LOAD:STATe <filename>.</p> <p>If you try to recall a State file for a mode that is not licensed or not available in the instrument, an error message will occur and the state will not change.</p>
Backwards Compatibility Notes	<p>In legacy analyzers, it was possible to load a state without affecting the trace data, limit lines or correction data. Similarly (since User Preset is actually loading a state), it was possible to do a User Preset without affecting the trace data, limit lines or correction data.</p> <p>In the X-Series, "state" always includes all of this data; so whenever state is loaded, all of the traces, limit lines and corrections are affected. Although this differs from previous behavior, it is desirable behavior, and should not cause adverse issues for users.</p>
Backwards Compatibility Notes	<p>Recall for the X-Series supports backward compatibility in the sense that you can recall a state file from any X-Series model number and any version of X-Series software. This is only possible if part of the recalling process goes through a limiting step after recalling the mode settings, at least for settings that may vary with version number, model number, option and license differences. If you try to recall a state file onto an instrument with less capability than what was available on the instrument during the save, the recall will ignore the state it doesn't support and it will limit the recalled setting to what it allows.</p> <p>Example: if the saved state includes preamp ON, but the recalling instrument does not have a preamp; the preamp is limited to OFF. Conversely, if you save a state without a preamp, the preamp is OFF in the state file. When this saved file is recalled on an instrument with a licensed preamp, the preamp is changed to OFF. Another example is if the saved state has center frequency set to 20 GHz, but the instrument recalling the saved state is a different model and only supports 13.5 GHz. In this case, the center frequency is limited along with any other frequency based settings. Since the center frequency can't be preserved in this case, the recall limiting tries to at least preserve span to keep the measurement setup as intact as possible.</p> <p>It may be appropriate to issue a warning if the state is limited on the recall; warnings do not go out to SCPI so this would only affect the manual user.</p> <p>Note that there is no state file compatibility outside of the X-Series. For example, you cannot recall a state file from ESA or PSA.</p>
Initial S/W Revision	Prior to A.02.00

State

The Recall State menu lets you choose a register or file from which to recall the state.

The content of a state file includes all of the settings and data required to return the analyzer as closely as possible to the Mode it was in, with the exact settings that were in place, when the save occurred. The Mode settings in each state file include the settings that are affected by Mode Preset, as well as the additional settings affected by Restore Mode Defaults; all of the Mode's settings. In addition, all of the settings of the Input/Output system are included, even though they are outside of the Mode's state, because they are needed to restore the complete setup. Persistent System settings (for example, GPIB address) are not affected by either a Mode Preset or Restore Mode Defaults, nor are they included in a saved State file.

Since each state file is only for one Mode, the settings for other Modes are unaffected when it is loaded. Recall State will cause a mode switch if the state being recalled is not from the current active mode.

After the recall completes, the message "File <filename> recalled" or "Recalled State Register <register number>" is displayed.

For rapid recalls, the State menu lists 16 registers that you can choose from to recall. Pressing a Register key initiates the recall. You can also select a file from which to recall.

The default path for all State Files is:

My Documents\<<mode name>\state

where <mode name> is the parameter used to select the mode with the INST:SEL command (for example, SA for the Spectrum Analyzer).

See ["More Information" on page 1560](#).

Key Path	Recall
Mode	All
Remote Command	:MMEMory:LOAD:STATe <filename>
Example	:MMEM:LOAD:STAT "myState.state" This recalls the file myState.state on the default path
Example	MMEM:LOAD:STAT "MyStateFile.state" This loads the state file data (on the default file directory path) into the instrument state.
Notes	<p>When you pick a file to recall, the analyzer first verifies that the file is recallable in the current instrument by checking the software version and model number of the instrument. If everything matches, a full recall proceeds by aborting the currently running measurement, clearing any pending operations, and then loading the State from the saved state file. You can open state files from any mode, so recalling a State file switches to the mode that was active when the save occurred. After switching to the mode of the saved state file, mode settings and data (if any for the mode) are loaded with values from the saved file. The saved measurement of the mode becomes the newly active measurement and the data relevant to the measurement (if there is any) is recalled.</p> <ul style="list-style-type: none"> • If there is a mismatch between file version or model number or instrument version or model number, the recall function tries to recall as much as possible and returns a warning message. It may limit settings that differ based on model number, licensing or version number. <p>After recalling the state, the Recall State function does the following:</p> <ul style="list-style-type: none"> • Makes the saved measurement for the mode the active measurement. • Clears the input and output buffers. • Status Byte is set to 0.

	<ul style="list-style-type: none"> • Executes a *CLS <p>If the file specified is empty an error is generated. If the specified file does not exist, another error is generated. If there is a mismatch between the file and the proper file type, an error is generated. If there is a mismatch between file version or model number or instrument version or model number, a warning is displayed. Then it returns to the State menu and File Open dialog goes away.</p> <p>After the Recall, the analyzer exits the Recall menu and returns to the previous menu.</p>
Backwards Compatibility SCPI	:MMEMory:LOAD:STATe 1,<filename>
Initial S/W Revision	Prior to A.02.00

More Information

In measurements that support saving Traces, for example, Swept SA, the Trace data is saved along with the State in the State file. When recalling the State, the Trace data is recalled as well. Traces are recalled exactly as they were stored, including the writing mode and update and display modes. If a Trace was updating and visible when the State was saved, it will come back updating and visible, and its data will be rewritten right away. When you use State to save and recall traces, any trace whose data must be preserved should be placed in View or Blank mode before saving.

The following table describes the Trace Save and Recall possibilities:

You want to recall state and one trace's data, leaving other traces unaffected.	Save Trace+State from 1 trace. Make sure that no other traces are updating (they should all be in View or Blank mode) when the save is performed.	On Recall, specify the trace you want to load the one trace's data into. This trace will load in View. All other traces' data will be unaffected, although their trace mode will be as it was when the state save was performed.
You want to recall all traces	Save Trace+State from ALL traces.	On Recall, all traces will come back in View (or Blank if they were in Blank or Background when saved)
You want all traces to load exactly as they were when saved.	Save State	On recall, all traces' mode and data will be exactly as they were when saved. Any traces that were updating will have their data immediately overwritten.

From File...

When you press "From File", the analyzer brings up a Windows dialog and a menu entitled "File Open." This menu allows you to navigate to the various fields in the Windows dialog without using a keyboard or mouse. The Tab and Arrow keys can also be used for dialog navigation.

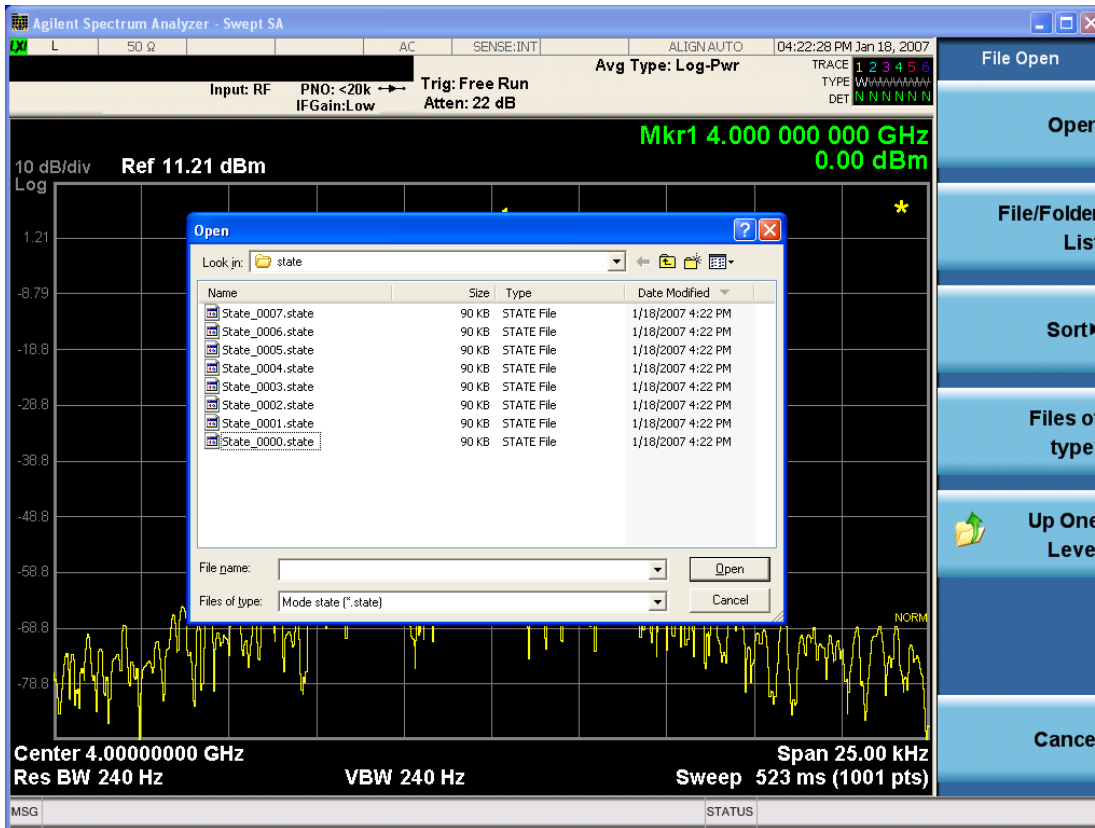

Listed below are the functions of the various fields in the dialog, and the corresponding softkeys:

Open

Performs the recall of the specified file. While the recall is being performed, the floppy icon appears briefly in the Meas bar.

File/Folder List

Enables you to navigate to the center of the dialog that contains the list of files and folders. Once here you can get information about the file and use the tab keys to navigate to the other fields in the dialog, such as Look In.

Look In

The Look In field shows the path from which the file will be recalled and allows you to change the path using the up and down arrow keys to navigate to other paths; the Enter key to open a directory; and the Backspace key to go back one directory. The **Look In field** first uses the last path from the Save As dialog **Save In:** path for that same file type. There is no softkey for directly navigating to the Look In field, but you can use the left tab to get here from the File/Folder List.

User specified paths are remembered when you leave and return to a Mode and are reset back to the default using Restore Mode Defaults.

Sort

Accesses a menu that enables you to sort the files within the File Open dialog. Only one sorting type can be selected at a time and the sorting happens immediately. The sorting types are By Date, By Name, By extension, and By Size.

Files of Type

This field shows the file suffix for the type of file you have selected to recall. For example, if you navigated here while recalling State, "Mode state (*.state)" is in the field. If you navigated here while recalling Trace, ""Mode state (*.trace)" is in the field. If you navigated here while importing a trace data file, "Trace Data (*.csv)" is in the field. For some file types, there is more than one choice in the dropdown menu, which you can select by using the up and down arrow keys and Enter.

Up One Level

This key corresponds to the icon of a folder with the up arrow that is in the tool bar of the dialog. When pressed, it causes the file and folder list to navigate up one level in the directory structure. The Backspace key does the same thing.

Cancel

This key corresponds to the Cancel selection in the dialog. It causes the current **Open** request to be cancelled. The ESC key does the same thing.

Key Path	Recall, State
Notes	Brings up the Open dialog for recalling a State Save Type
Initial S/W Revision	Prior to A.02.00

Edit Register Names

You may enter a custom name on any of the Register keys, to help you remember what you are using that state to save. To do this, press the Edit Register Names key, choose the register whose name you wish to edit, and then enter the desired label using the Alpha Editor or an external PC keyboard.

The maximum number of characters that can be added is 30. In most cases, 30 characters will fit on two lines of the key.

For more information and the SCPI command, see Edit Register Names under the Save, State function.

Key Path	Recall, State
Mode	All
Dependencies	N9060A-7FP or N9060B-2FP license required to edit the register names. When the feature is not licensed, sending the SCPI command generates an error, -221, "Settings conflict;Option not available"
Initial S/W Revision	A.11.00

Register 1 thru Register 16

Selecting any one of these register keys causes the State of the mode from the specified Register to be recalled. Each of the register keys annotates whether it is empty or at what date and time it was last

modified. In addition, you can use the Edit Register Names key under Save, State to enter custom names for each register.

NOTE

In products that run multiple instances of the X-Series Application, recalling the same register name on each instance is a way to share setups between the instances.

Registers are shared by all modes, so recalling from any one of the registers will cause a mode switch to the mode that was active when the save to the Register occurred.

Although these 16 registers are the only registers available from the front panel, there are 128 state registers available in the instrument. Registers 17–128 are only available from the SCPI interface, using the *RCL command.

After the recall completes, the message "Register <register number> recalled" appears in the message bar. If you are in the Spectrum Analyzer Mode, and you are recalling a register that was saved in the Spectrum Analyzer Mode, then after the recall, you will still be in the Recall Register menu. If the Recall causes you to switch modes, then after the Recall, you will be in the Frequency menu.

If a requested register is empty an error is generated.

Key Path	Recall, State
Example	*RCL 1
Range	1–16 from front panel, 1–128 from SCPI
Readback	Date and time with seconds resolution are displayed on the key OR A custom name of up to 30 characters entered using the Save, State, Edit Register Names key OR “(empty)” if no prior save operation has been performed to this register.
Initial S/W Revision	Prior to A.02.00
Modified at S/W Revision	Prior to A.11.00

Register 1 thru Register 16

Selecting any one of these register keys causes the State of the mode from the specified Register to be recalled. Each of the register keys annotates whether it is empty or at what date and time it was last modified. In addition, you can use the Edit Register Names key under Save, State to enter custom names for each register.

NOTE

In products that run multiple instances of the X-Series Application, recalling the same register name on each instance is a way to share setups between the instances.

Registers are shared by all modes, so recalling from any one of the registers will cause a mode switch to the mode that was active when the save to the Register occurred.

Although these 16 registers are the only registers available from the front panel, there are 128 state registers available in the instrument. Registers 17–128 are only available from the SCPI interface, using the *RCL command.

After the recall completes, the message "Register <register number> recalled" appears in the message bar. If you are in the Spectrum Analyzer Mode, and you are recalling a register that was saved in the Spectrum Analyzer Mode, then after the recall, you will still be in the Recall Register menu. If the Recall causes you to switch modes, then after the Recall, you will be in the Frequency menu.

If a requested register is empty an error is generated.

Key Path	Recall, State
Example	*RCL 1
Range	1-16 from front panel, 1-128 from SCPI
Readback	Date and time with seconds resolution are displayed on the key OR A custom name of up to 30 characters entered using the Save, State,Edit Register Names key OR "(empty)" if no prior save operation has been performed to this register.
Initial S/W Revision	Prior to A.02.00
Modified at S/W Revision	Prior to A.11.00

Sequences

These keys allow you to import a Tab separated or .txt file that will automatically setup all the parameters required for building a Sequence. The parameters will automatically be loaded into the Stated Sequencer.

Once selected, in order to import the selected Sequence Type you must select the Open key in the Source Sequence menu.

Key Path	Recall, Sequences
Mode	All
Remote Command	:MMEMory:LOAD:SEQuences: SLISt ALISt SAALISt "MySequence.txt"
Example	:MMEM:LOAD:SEQ:SLIS "MySequence.txt"
Notes	Available file types are: –CSV (Comma delimited) (*.csv) –Text (Tab delimited) (*.txt)
Initial S/W Revision	A.05.00

Source Sequence

The list of parameters, that configure steps, that makes up a sequence for the Source.

The Source sequence is a sequence of flexible configurable steps that can be set anywhere in the instruments frequency range.

Key Path	Recall,Sequences
----------	------------------

Example	:MMEM:LOAD:SEQ:SLIS "MySequence.txt"
Dependencies	Only available in XOBT
Initial S/W Revision	A.05.00

Open...

When you press "Open", the analyzer brings up a Windows dialog and a menu entitled "File Open." This menu allows you to navigate to the various fields in the Windows dialog without using a keyboard or mouse. The Tab and Arrow keys can also be used for dialog navigation.

See "[From File...](#)" on page 2060 in Recall, State, for a full description of this dialog and menu.

Key Path	Recall, Data
Notes	The key location is mode-dependent and will vary. Brings up Open dialog for recalling a <mode specific> Save Type
Initial S/W Revision	Prior to A.02.00

Data (Import)

Importing a data file loads data that was previously saved from the current measurement or from other measurements and/or modes that produce compatible data files. The Import Menu only contains Data Types that are supported by the current measurement.

Since the commonly exported data files are in .csv format, the data can be edited by the user prior to importing. This allows you to export a data file, manipulate the data in Excel (the most common PC Application for manipulating .csv files) and then import it.

Importing Data loads measurement data from the specified file into the specified or default destination, depending on the data type selected. Selecting an Import Data menu key will not actually cause the importing to occur, since the analyzer still needs to know from where to get the data. Pressing the Open key in this menu brings up the Open dialog and Open menu that provides you with the options from where to recall the data. Once a filename has been selected or entered in the Open menu, the recall occurs as soon as the Open button is pressed.

Key Path	Recall
Mode	All
Notes	The menu is built from whatever data types are available for the mode. Some keys will be missing completely, so the key locations in the sub-menu will vary. No SCPI command directly controls the Data Type that this key controls. The Data Type is included in the MMEM:LOAD commands.
Dependencies	If a file type is not used by a certain measurement, it is grayed out for that measurement. The key for a file type will not show at all if there are no measurements in the Mode that support it.
Preset	Is not affected by Preset or shutdown, but is reset during Restore Mode Defaults

Readback	The data type that is currently selected
Initial S/W Revision	Prior to A.02.00

Capture Buffer

Capture buffer functionality is available only in Code Domain and Modulation Accuracy measurements. The captured data is raw data which is not processed.

Key Path	Recall, Data
Mode	CDMA2000
Example	MMEM:LOAD:CAPT "MyCaptureData.bin" This loads the file of capture data (on the default file directory path) into the instrument.
Dependencies	Capture buffer data is only available for Code Domain and Modulation Accuracy measurement. In other measurements, this key is grayed out.

Open...

When you press "Open", the analyzer brings up a Windows dialog and a menu entitled "File Open." This menu allows you to navigate to the various fields in the Windows dialog without using a keyboard or mouse. The Tab and Arrow keys can also be used for dialog navigation.

See "[From File...](#)" on page 2060 in Recall, State, for a full description of this dialog and menu.

Key Path	Recall, Data
Notes	The key location is mode-dependent and will vary. Brings up Open dialog for recalling a <mode specific> Save Type
Initial S/W Revision	Prior to A.02.00

Restart

The Restart function restarts the current sweep, or measurement, or set of averaged/held sweeps or measurements. If you are Paused, pressing Restart does a Resume.

The Restart function is accessed in several ways:

- Pressing the Restart key
- Sending the remote command INIT:IMMEDIATE
- Sending the remote command INIT:RESTART

See "[More Information](#)" on page 1567

Key Path	Front-panel key
Remote Command	:INITiate[:IMMEDIATE] :INITiate:RESTART
Example	:INIT:IMM :INIT:REST
Notes	:INITiate:RESTART and :INITiate:IMMEDIATE perform exactly the same function.
Couplings	Resets average/hold count k. For the first sweep overwrites all active (update=on) traces with new current data. For application modes, it resets other parameters as required by the measurement.
Status Bits/OPC dependencies	This is an Overlapped command. The STATUS:OPERation register bits 0 through 8 are cleared. The STATUS:QUESTIONable register bit 9 (INTEgrity sum) is cleared. The SWEEPING bit is set. The MEASURING bit is set.
Backwards Compatibility Notes	For Spectrum Analysis mode in ESA and PSA, the Restart hardkey and the INITiate:RESTART command restart trace averages (displayed average count reset to 1) for a trace in Clear Write, but did not restart Max Hold and Min Hold. In the X-Series, the Restart hardkey and the INITiate:RESTART command restart not only Trace Average, but MaxHold and MinHold traces as well. For wireless comms modes in ESA and PSA, the Restart hardkey and the INITiate:RESTART command restart every measurement, which includes all traces and numeric results. There is no change to this operation.
Initial S/W Revision	Prior to A.02.00

More Information

The **Restart** function first aborts the current sweep/measurement as quickly as possible. It then resets the sweep and trigger systems, sets up the measurement and initiates a new data measurement sequence with a new data acquisition (sweep) taken once the trigger condition is met.

If the analyzer is in the process of aligning when **Restart** is executed, the alignment finishes before the restart function is performed.

Even when set for Single operation, multiple sweeps may be taken when Restart is pressed (for example, when averaging/holding is on). Thus when we say that **Restart** "restarts a measurement," we may mean:

- It restarts the current sweep
- It restarts the current measurement
- It restarts the current set of sweeps if any trace is in Trace Average, Max Hold or Min Hold
- It restarts the current set of measurements if Averaging, or Max Hold, or Min Hold is on for the measurement
- depending on the current settings.

With **Average/Hold Number** (in **Meas Setup** menu) set to 1, or Averaging off, or no trace in Trace Average or Hold, a single sweep is equivalent to a single measurement. A single sweep is taken after the trigger condition is met; and the analyzer stops sweeping once that sweep has completed. However, with **Average/Hold Number** >1 and at least one trace set to **Trace Average, Max Hold, or Min Hold (SA Measurement)** or **Averaging on (most other measurements)**, multiple sweeps/data acquisitions are taken for a single measurement. The trigger condition must be met prior to each sweep. The sweep is stopped when the average count k equals the number N set for **Average/Hold Number**. A measurement average usually applies to all traces, marker results, and numeric results; but sometimes it only applies to the numeric results.

Once the full set of sweeps has been taken, the analyzer will go to idle state. To take one more sweep without resetting the average count, increment the average count by 1, by pressing the step up key while **Average/Hold Number** is the active function, or sending the remote command CALC: AVER: TCON UP.

Save

The Save menu lets you choose what you want to save and where you want to save it. Among the types of files you can save are **States**, **Traces**, and **Screen Images**. In addition, an Export (Data) option lets you save a number of data types as CSV files for easy import into Excel and other spreadsheet programs.

Key Path	Front-panel key
Mode	All
Notes	No remote command for this key specifically, but the :MMEM:STORe command is available for specific file types. An example is :MMEM:STOR:STATe <filename>.
Initial S/W Revision	Prior to A.02.00

State

The Save State menu lets you choose a register or file for saving the state.

NOTE

In products that run multiple instances of the X-Series Application, all instances share the same register and file location where you want to save the state.

The content of a state file includes all of the settings and data required to return the analyzer as closely as possible to the Mode it was in, with the exact settings which were in place, when the save occurred. The Mode settings in each state file include the settings that are affected by Mode Preset, as well as the additional settings affected by Restore Mode Defaults; all of the Mode's settings. In addition, all of the settings of the Input/Output system are included, even though they are outside of the Mode's state, because they are needed to restore the complete setup. Persistent System settings (for example, Verbose SCPI) are not affected by either Mode Preset or Restore Mode Defaults, nor are they included in a saved State file.

After the save completes, the message "File <filename> saved" or "State Register <register number> saved" is displayed.

For rapid saving, the State menu lists 16 registers to save to. Pressing a Register key initiates the save. You can also select a file to save to.

The default path for all State Files is:

My Documents\<<mode name>\state

where <mode name> is the parameter used to select the mode with the INST:SEL command (for example, SA for the Spectrum Analyzer).

Key Path	Save
Mode	All
Remote Command	:MMEMory:STORe:STATe <filename>
Example	MMEM:STOR:STATe "MyStateFile.state" This stores the current instrument state data in the file MyStateFile.state in the default directory.
Notes	Both single and double quotes are supported for any filename parameter over remote.

After saving to a register, that register's menu key is updated with the date the time, unless a custom label has been entered for that key.

After saving to a register, you remain in the Save State menu, so that you can see the Register key update. After saving to a file, the analyzer automatically returns to the previous menu and any Save As dialog goes away.

Backwards :MMEMory:STORE:STATE 1,<filename>

Compatibility SCPI For backwards compatibility, the above syntax is supported. The "1" is simply ignored. The command is sequential.

Initial S/W Revision Prior to A.02.00

To File . . .

When you press "To File", the analyzer brings up a Windows dialog and a menu entitled "Save As." This menu allows you to navigate to the various fields in the Windows dialog without using a keyboard or mouse. The Tab and Arrow keys can also be used for dialog navigation.

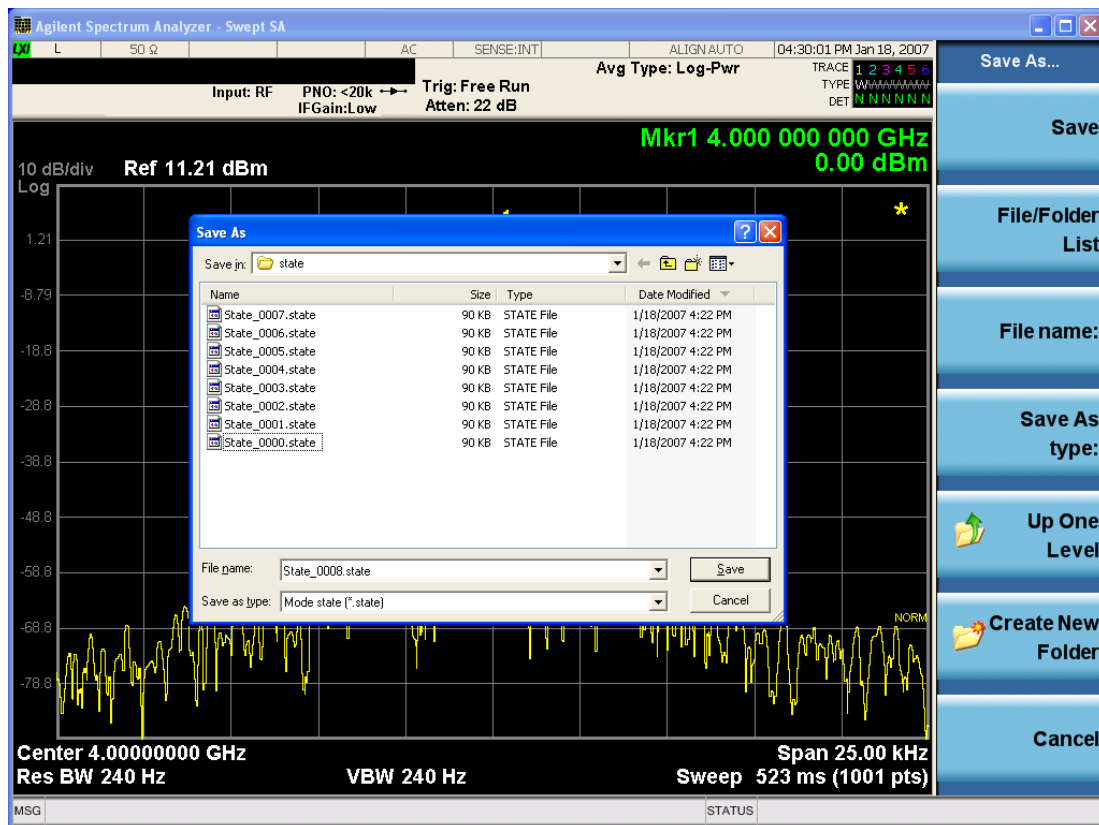

The Listed below

are the functions of the various fields in the dialog, and the corresponding softkeys:

Save

Performs the save to the specified file of the selected type. If the file already exists, a dialog will appear that allows you to replace the existing file by selecting OK, or you can Cancel the request. If you select OK,

the file will be overwritten. Using the C: drive is strongly discouraged, since it runs the risk of being overwritten during an instrument software upgrade.

While the save is being performed, the floppy icon appears briefly in the Meas bar.

File/Folder List

Enables you to navigate to the center of the dialog that contains the list of files and folders. Once here you can get information about the file and use the tab keys to navigate to the other fields in the dialog, such as Save In.

Save In

The Save In field shows the path to which the file will be saved and allows you to change the path using the up and down arrow keys to navigate to other paths; the Enter key to open a directory; and the Backspace key to go back one directory. The **Save In field** defaults to the default path for this type of file and remembers the last path you used to save this type of file. There is no softkey for directly navigating to the Save In field but you can use left tab to get here from the File/Folder List.

User specified paths are remembered when you leave and return to a Mode and are reset back to the default using Restore Mode Defaults.

File Name

The File Name field is initially loaded with an automatically generated filename specific to the appropriate Save Type. The automatically generated filename is guaranteed not to conflict with any filename currently in the directory. You may replace or modify this filename using the File Name key. See the ["Quick Save " on page 2056](#) documentation for more on the automatic file naming algorithm.

When you press the File Name key the analyzer displays the Alpha Editor. Use the knob to choose the letter to add and the front-panel Enter key to add the letter to the file name. The BK character moves you back and the FW character moves you forward in the filename. The Select key on the front panel generates a space character. When you are done entering the filename press the Done softkey. This returns back to the **File Open** dialog and menu, but does not cause the save to occur.

Save As Type

This field shows the file suffix for the type of file you have selected to save. For example, if you navigated here while saving State, "Mode state (*.state)" is in the field. If you navigated here from saving Trace, ""Mode state (*.trace)" is in the field. If you navigated here while exporting a trace data file, "Trace Data (*.csv)" is in the field. For some file types, there is more than one choice in the dropdown, which you can select by using the up and down arrow keys and Enter.

Up One Level

This key corresponds to the icon of a folder with the up arrow that is in the tool bar of the dialog. When pressed, it causes the file and folder list to navigate up one level in the directory structure. The Backspace key does the same thing.

Create New Folder

This key corresponds to the icon of a folder with the "*" that is in the tool bar of the dialog. When pressed, a new folder is created in the current directory with the name **New Folder** and you can enter a new folder name using the Alpha Editor.

Cancel

This key corresponds to the Cancel selection in the dialog. It causes the current **Save As** request to be cancelled. The ESC key does the same thing.

Key Path	Save, State
Mode	All
Notes	Brings up Save As dialog for saving a State Save Type
Initial S/W Revision	Prior to A.02.00

Edit Register Names

You may enter a custom name on any of the Register keys, to help you remember what you are using that state to save. To do this, press the Edit Register Names key, choose the register whose name you wish to edit, and then enter the desired label using the Alpha Editor or an external PC keyboard.

The maximum number of characters that can be added is 30. In most cases, 30 characters will fit on two lines of the key.

See ["More Information" on page 1572](#)

Key Path	Save, State
Mode	All
Remote Command	:MMEMory:REGister:STATe:LABel <reg number>,"label" :MMEMory:REGister:STATe:LABel? <reg number>
Example	:MMEM:REG:STAT:LAB 1,"my label"
Notes	<reg number> is an integer from 1 to 16. If the SCPI specifies an invalid register number an error message is generated, -222,"Data out of range;Invalid register label number" "label" is a string from 0 to 30 characters in length. If a label exceeds 30 characters, an error message is generated, -150,"String data error;Label clipped to 30 characters" "label" of length 0 erases the custom label and restores the default (time and date) label. E.g.: :MMEM:REG:STAT:LAB 1,""
Dependencies	N9060A-7FP or N9060B-2FP license required to edit the register names. When the feature is not licensed, sending this command generates an error, -221,"Settings conflict;Option not available"
Preset	The names are unaffected by Preset or power cycle but are set to the default label (time and date) on a "Restore System Defaults->Misc"
Initial S/W Revision	A.11.00

More Information

When you edit one of the register names, the time and date field will be replaced by the custom name.

If you delete all the characters in the custom name, it restores the default (time and date).

The register names are stored within the state files, but they are not part of the instrument state; that is, once you have edited a register name, loading a new state will not change that register name. Another

consequence of this is that the names will be persistent through a power cycle. Also, if a named state file is transferred to another analyzer, it will bring its custom name along with it.

If you try to edit the name of an empty register, the analyzer will first save the state to have a file to put the name in. If you load a named state file into an analyzer with older firmware it will ignore the metadata.

The *SAV and *RCL commands will not be affected by the custom register names, nor will the MMEM commands.

Register 1 thru Register 16

Selecting any one of these register menu keys causes the State of the currently active mode to be saved to the specified Register. The registers are provided for rapid saving and recalling, since you do not need to specify a filename or navigate to a file. Each of the register menu keys annotates whether it is empty or at what date and time it was last modified. In addition, you can use the Edit Register Names key to enter custom names for each register.

NOTE

In products that run multiple instances of the X-Series Application, save with different register name if you do not want to overwrite the register of another running instance.

Although these 16 registers are the only registers available from the front panel, there are 128 state registers available in the instrument. Registers 17–128 are only available from the SCPI interface, using the *SAV command.

There is one set of 128 state registers in the instrument, not one set for each Mode. When a state is saved, the Mode it was saved from is saved with it; then when it is recalled, the instrument switches to that Mode.

After the save completes, the corresponding register menu key annotation is updated with the date and time and the message "Register <register number> saved" is displayed.

Key Path	Save, State
Mode	All
Example	*SAV 1
Range	1–16 from front panel, 1–128 from SCPI
Readback	Date and time with seconds resolution are displayed on the key OR A custom name of up to 30 characters entered using the Edit Register Names key OR “(empty)” if no prior save operation has been performed to this register.
Initial S/W Revision	Prior to A.02.00
Modified at S/W Revision	A.11.00

Register 1 thru Register 16

Selecting any one of these register menu keys causes the State of the currently active mode to be saved to the specified Register. The registers are provided for rapid saving and recalling, since you do not need to specify a filename or navigate to a file. Each of the register menu keys annotates whether it is empty or at

what date and time it was last modified. In addition, you can use the Edit Register Names key to enter custom names for each register.

NOTE In products that run multiple instances of the X-Series Application, save with different register name if you do not want to overwrite the register of another running instance.

Although these 16 registers are the only registers available from the front panel, there are 128 state registers available in the instrument. Registers 17–128 are only available from the SCPI interface, using the *SAV command.

There is one set of 128 state registers in the instrument, not one set for each Mode. When a state is saved, the Mode it was saved from is saved with it; then when it is recalled, the instrument switches to that Mode.

After the save completes, the corresponding register menu key annotation is updated with the date and time and the message "Register <register number> saved" is displayed.

Key Path	Save, State
Mode	All
Example	*SAV 1
Range	1–16 from front panel, 1–128 from SCPI
Readback	Date and time with seconds resolution are displayed on the key OR A custom name of up to 30 characters entered using the Edit Register Names key OR “(empty)” if no prior save operation has been performed to this register.
Initial S/W Revision	Prior to A.02.00
Modified at S/W Revision	A.11.00

Mass Storage Catalog (Remote Command Only)

Key path	SCPI Only
Remote Command	:MMEMory:CATalog? [<directory_name>]
Notes	The string must be a valid logical path. Queries disk usage information (drive capacity, free space available) and obtains a list of files and directories in a specified directory in the following format: <numeric_value>,<numeric_value>,{<file_entry>} It returns two numeric parameters and as many strings as there are files and directories. The first parameter indicates the total amount of storage currently used in bytes. The second parameter indicates the total amount of storage available, also in bytes. The <file_entry> is a string. Each <file_entry> indicates the name, type, and size of one file in the directory list: <file_name>,<file_type>,<file_size> As the windows file system has an extension that indicates file type, <file_type> is always empty. <file_size> provides the size of the file in bytes. For directories, <file_entry> is surrounded by square brackets and both <file_type> and <file_size> are empty
Initial S/W Revision	Prior to A.02.00

Mass Storage Change Directory (Remote Command Only)

Key path	SCPI Only
Remote Command	:MMEMory:CDIRectory [<directory_name>] :MMEMory:CDIRectory?
Notes	The string must be a valid logical path. Changes the default directory for a mass memory file system. The <directory_name> parameter is a string. If no parameter is specified, the directory is set to the *RST value. At *RST, this value is set to the default user data storage area, that is defined as System.Environment.SpecialFolder.Personal. Query returns full path of the default directory.
Initial S/W Revision	Prior to A.02.00

Mass Storage Copy (Remote Command Only)

Key path	SCPI Only
Remote Command	:MMEMory:COPY <string>,<string>[,<string>,<string>]
Notes	The string must be a valid logical path. Copies an existing file to a new file or an existing directory to a new directory. Two forms of parameters are allowed. The first form has two parameters. In this form, the first parameter specifies the source, and the second parameter specifies the destination. The second form has four parameters. In this form, the first and third parameters specify the source. The second and fourth parameters specify the directories. The first pair of parameters specifies the source. The second pair specifies the destination. An error is generated if the source doesn't exist or the destination file already exists. This command will generate an "access denied" error if the destination is a restricted folder (e.g., C:\Windows) and the current user does not have Power User or Administrator privileges.

Mass Storage Device Copy (Remote Command Only)

This command transfers data to/from a file and a peripheral device.

Key path	SCPI Only
Remote Command	:MMEMory:COPY:DEvice <source_string>,<dest_string>
Notes	The strings must be a valid logical path or a valid device keyword. If the dest_string is a device keyword, the data is copied from the source file to the device. If the source_string is a device keyword, the data is copied to the source file from the device. Valid device keywords are: SNS (smart noise source) An error is generated if the file or device is not found.

Mass Storage Delete (Remote Command Only)

Key path	SCPI Only
Remote Command	:MMEMory:DELeTe <file_name>[,<directory_name>]
Notes	The string must be a valid logical path. Removes a file from the specified directory. The <file_name> parameter specifies the file name to be removed. This command will generate an “access denied” error if the file is in a restricted folder (e.g., C:\Windows) and the current user does not have Power User or Administrator privileges.
Initial S/W Revision	Prior to A.02.00

Mass Storage Data (Remote Command Only)

Creates a file containing the specified data OR queries the data from an existing file.

Key path	SCPI Only
Remote Command	:MMEMory:DATA <file_name>, <data> :MMEMory:DATA? <file_name>
Notes	The string must be a valid logical path. The command form is MMEMory:DATA <file_name>,<data>. It loads <data> into the file <file_name>. <data> is in 488.2 block format. <file_name> is string data. The query form is MMEMory:DATA? <file_name> with the response being the associated <data> in block format.
Initial S/W Revision	Prior to A.02.00

Mass Storage Make Directory (Remote Command Only)

Key path	SCPI Only
Remote Command	:MMEMory:MDIRectory <directory_name>
Notes	The string must be a valid logical path. Creates a new directory. The <directory_name> parameter specifies the name to be created. This command will generate an “access denied” error if the new directory would be in a restricted folder (e.g., C:\Windows) and the current user does not have Power User or Administrator privileges.
Initial S/W Revision	Prior to A.02.00

Mass Storage Move (Remote Command Only)

Key path	SCPI Only
Remote Command	:MMEMory:MOVE <string>,<string>[,<string>,<string>]
Notes	The string must be a valid logical path. Moves an existing file to a new file or an existing directory to a new directory.

Two forms of parameters are allowed. The first form has two parameters. In this form, the first parameter specifies the source, and the second parameter specifies the destination.

The second form has four parameters. In this form, the first and third parameters specify the source. The second and fourth parameters specify the directories. The first pair of parameters specifies the source. The second pair specifies the destination. An error is generated if the source doesn't exist or the destination file already exists.

This command will generate an "access denied" error if the destination is a restricted folder (e.g., C:\Windows) and the current user does not have Power User or Administrator privileges.

Initial S/W Revision Prior to A.02.00

Mass Storage Remove Directory (Remote Command Only)

Key path SCPI Only

Remote Command :MMEMory:RDIrectory <directory_name>

Notes The string must be a valid logical path.

Removes a directory. The <directory_name> parameter specifies the directory name to be removed. All files and directories under the specified directory shall also be removed.

This command will generate an "access denied" error if the folder is a restricted folder (e.g., C:\Windows) or is in a restricted folder and the current user does not have Power User or Administrator privileges.

Initial S/W Revision Prior to A.02.00

Mass Storage Determine Removable Media (Remote Command Only)

This command is used to determine if any removable media devices are connected to the instrument. Primarily, these are USB memory devices plugged-in to the front panel or rear panel USB ports. On instruments with PC6 or PC7 CPU's, one SD card slot is available for removable media. The instrument's primary disk drive is not a removable media device.

Key Path SCPI Only

Remote Command :MMEMory:RMEDia:LIST?

Notes The return value will be a string containing a list of partition identifiers which are removable media devices. Each identifier will be separated by a comma. If no removable media is present, an empty string will be returned.

Examples:

One removable device present will result in a return string of "F:".

Two removable devices present will result in a return string of "F:,G:".

No removable devices present will result in a return string of "".

Initial S/W Revision x.15.00

Mass Storage Determine Removable Media Label (Remote Command Only)

This command is used to set or query a removable media device's label.

Key Path	SCPI Only
Remote Command	:MMEMory:RMEDia:LABel <partition>,<string> :MMEMory:RMEDia:LABel? <partition>
Example	MMEM:RMED:LAB "F:","My Device"
Notes	If the <partition> specified does not exist or is not a removable media device the error -252,"Missing Media" will be generated. Setting the removable media label requires Administrative privileges. If the currently logged in user does not have appropriate privileges the error "-221.9900,Settings conflict;Administrator privileges required" is generated.
Initial S/W Revision	x.15.00

Mass Storage Determine Removable Media Write-protect status (Remote Command Only)

This command is used to query a removable media device's write-protect status.

Key Path	SCPI Only
Remote Command	:MMEMory:RMEDia:WPRotect? <partition>
Example	MMEM:RMED:WPR? "F:"
Notes	The return value is 1 if the device is write-protected, and 0 if the device is write-enabled. If the <partition> specified does not exist or is not a removable media device the error -252,"Missing Media" will be generated.
Preset	The return value will be depending on SD card installed.
Initial S/W Revision	x.15.00

Mass Storage Determine Removable Media size (Remote Command Only)

This command is used to query a removable media device's total memory size (not available memory size).

Key Path	SCPI Only
Remote Command	:MMEMory:RMEDia:SIZE? <partition>
Example	MMEM:RMED:SIZE? "F:"
Notes	The return value is integer value in GBytes. Any device which is less than 1 GB will return 0 GB. If the <partition> specified does not exist or is not a removable media device the error -252,"Missing Media" will be generated.
Initial S/W Revision	x.15.00

Sequences

These keys allow you to save a Tab separated or CSV file of the setup parameters required to build a Sequence.

In order to save you must select the Save As button and choose a destination folder.

Key Path	Save, Sequences
Mode	All
Remote Command	:MMEM:STOR:SEquences: SLIS ALIS SAALIS SStep "MySequence.txt"
Example	:MMEM:STOR:SEQ:SLIS "MySequence.txt"
Notes	Available file types are: –CSV (Comma delimited) (*.csv) –Text (Tab delimited) (*.txt)
Initial S/W Revision	A.05.00

Source Sequence

The list of parameters, that configure steps, that makes up a sequence for the Source.

The Source sequence is a sequence of flexible configurable steps that can be set anywhere in the instruments frequency range.

Key Path	Save, Sequences
Example	:MMEM:STOR:SEQ:SLIS "MySequence.txt"
Dependencies	Only available in XOBT
Initial S/W Revision	A.05.00

Save As . . .

This menu lets you select the location where you can save the Sequence. This menu is a standard Windows® dialog with Save As menu keys. The "File Name" field in the Save As dialog is initially loaded with an automatically generated filename specific to the appropriate Save Type. The automatically generated filename is guaranteed not to conflict with any filename currently in the directory. You may replace or modify this filename using the File Name softkey. See the Quick Save key documentation for more on the automatic file naming algorithm.

The default path for all Sequence Files is:

My Documents\Sequences

Key Path	Save, Sequences
Mode	All

Notes	Brings up Save As dialog for saving a Sequence Save Type
Initial S/W Revision	A.05.00

Data (Export)

Exporting a data file stores data from the current measurement to mass storage files. The Export Menu only contains data types that are supported by the current measurement.

Since the commonly exported data files are in .csv format, the data can be edited by you prior to importing. This allows you to export a data file, manipulate the data in Excel (the most common PC Application for manipulating .csv files) and then import it.

Selecting an Export Data menu key will not actually cause the exporting to occur, since the analyzer still needs to know where you wish to save the data. Pressing the Save As key in this menu brings up the Save As dialog and Save As menu that allows you to specify the destination file and directory. Once a filename has been selected or entered in the Open menu, the export will occur as soon as the Save key is pressed.

Key Path	Save
Mode	All
Notes	The menu is built from whatever data types are available for the mode. So the key locations in the sub menu will vary. No SCPI command directly controls the Data Type that this key controls. The Data Type is included in the MMEM:STORe commands.
Dependencies	If a file type is not used by a certain measurement, that type is grayed out for that measurement. The key for a file type will not show at all if there are no measurements in the Mode that support it.
Preset	Is not affected by a Preset or shutdown, but is reset during Restore Mode Defaults
Readback	The data type that is currently selected
Initial S/W Revision	Prior to A.02.00

Measurement Results

Pressing this key selects Meas Results as the data type to be exported. Pressing the key a second time brings up the Meas Results menu, which allows you to select which **Meas Result** to save. In the Swept SA measurement, there are three types of Measurement Results files: Peak Table, Marker Table and Spectrogram.

See "[Meas Results File Contents](#)" on page 1581.

See "[Marker Table](#)" on page 1581.

See "[Peak Table](#)" on page 1584.

See "[Spectrogram](#)" on page 1587

Remote Command	:MMEMory:STORe:RESults:MTABle PTABle SPECTrogram <filename>
-----------------------	---

Example	<p>:MMEM:STOR:RES:MTAB "myResults.csv" Saves the results from the current marker table to the file myResults.csv in the current path.</p> <p>:MMEM:STOR:RES:PTAB "myResults.csv" Saves the results from the current peak table to the file myResults.csv in the current path.</p> <p>:MMEM:STOR:RES:SPEC "myResults.csv" Saves the results from the current Spectrogram display to the file myResults.csv in the current path.</p> <p>The default path is My Documents\SA\data\SAN\results</p>
Notes	<p>If the save is initiated via SCPI, and the file already exists, the file will be overwritten.</p> <p>Using the C: drive is strongly discouraged, since it runs the risk of being overwritten during an instrument software upgrade.</p> <p>Both single and double quotes are supported for any filename parameter over SCPI.</p>
Dependencies	<p>If a save of Marker Table results is requested and the Marker Table is not on, no file is saved and a message is generated</p> <p>If a save of Peak Table results is requested and the Peak Table is not on, no file is saved and a message is generated</p> <p>If a save of Spectrogram results is requested and the Spectrogram is not on, no file is saved and a message is generated.</p> <p>The Spectrogram choice only appears if option EDP is licensed.</p>
Preset	Not part of Preset, but is reset to Peak Table by Restore Mode Defaults. Survives a shutdown.
Initial S/W Revision	Prior to A.02.00

Meas Results File Contents

All files are .csv files. The following section details the data in each file type.

Marker Table

This section discusses the Marker Table Meas Results file format.

Imagine that, at the point where a Marker Table Meas Result is requested, the following screen is showing:

12 Code Domain Measurement
Save

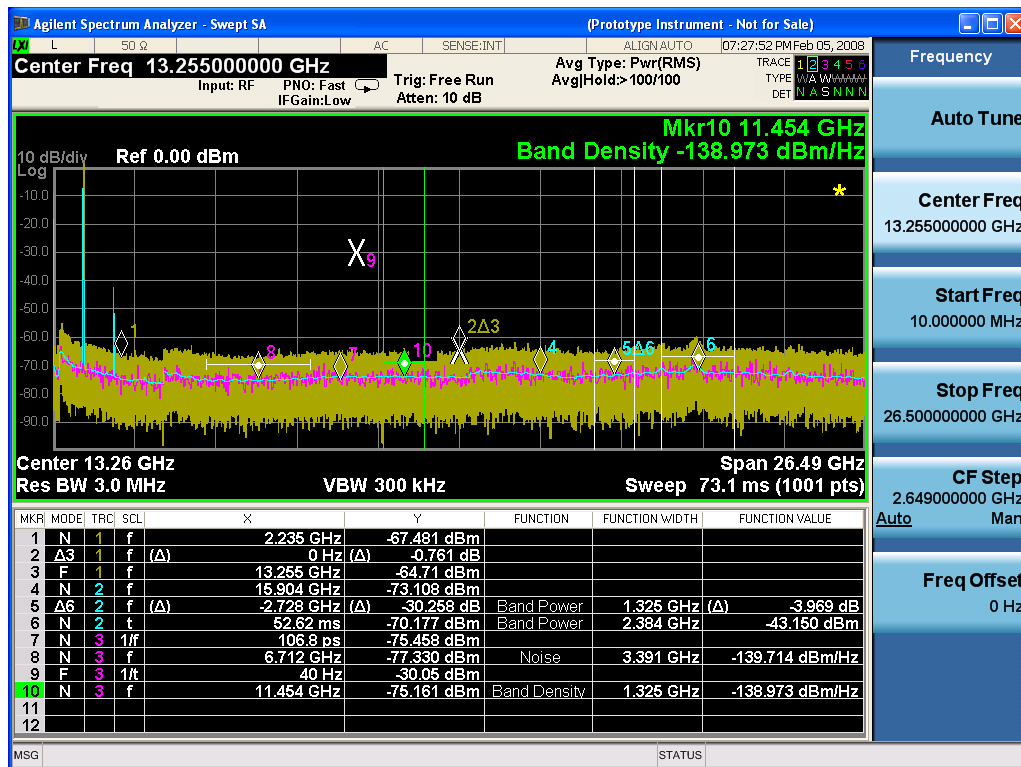

Then the Meas Results file, when opened, would show the following data:

MeasurementR	
result	
Swept SA	
A.01.40_R0017	N9020A
526 B25 PFR	1
P26 EA3	
Result Type	Marker Table
Ref Level	0
Number of Points	1001
Sweep Time	0.0662666 67
Start Frequency	10000000
Stop Frequency	26500000 000
Average Count	0
Average Type	LogPower (Video)
RBW	3000000

RBW Filter	Gaussian
RBW Filter BW	3dB
VBW	3000000
Sweep Type	Swept
X Axis Scale	Lin
PreAmp State	Off
PreAmp Band	Low
Trigger Source	Free
Trigger Level	1.2
Trigger Slope	Positive
Trigger Delay	1.00E-06
Phase Noise Optimization	Fast
Swept If Gain	Low
FFT If Gain	Autorange
RF Coupling	AC
FFT Width	411900
Ext Ref	10000000
Input	RF
RF Calibrator	Off
Attenuation	10
Ref Level Offset	0
External Gain	0
X Axis Units	Hz
Y Axis Units	dBm

DATA									
MKR	MODE	TR C	SCL	X	Y	FUNCTI ON	FUNCTIO N WIDTH	FUNCTI ON VALUE	FUNCTI ON UNIT
1	Normal	1	Freque ncy	2.2350E+09	- 67.481	Off	0.0000E+00	0	None
2	Delta3	1	Freque ncy	0.0000E+00	- 0.761	Off	0.0000E+00	0	None
3	Fixed	1	Freque ncy	1.3255E+10	- 64.71	Off	0.0000E+00	0	None
4	Normal	2	Freque ncy	1.5904E+10	- 73.1	Off	0.0000E+00	0	None

08									
5	Delta7	2	Frequ ncy	- 2.7280E+ 09	- 30.2 58	Band Power	1.3250E+ 06	-3.969	dB
6	Normal	2	Time	5.2620E- 02	- 70.1 77	Band Power	2.3840E+ 06	-43.15	dBm
7	Normal	3	Period	1.0680E- 10	- 75.4 58	Off	0.0000E+ 00	0	None
8	Normal	3	Frequ ncy	6.7120E+ 09	- 77.3 3	Noise	3.3910E+ 06	- 139.71 4	dBm/Hz
9	Fixed	3	Inverse Time	4.0000E+ 01	- 30.0 5	Off	0.0000E+ 00	0	None
10	Normal	3	Frequ ncy	1.1454E+ 10	- 75.1 61	Band Density	1.3250E+ 06	- 138.97 3	dBm/Hz
11	Off	1	Frequ ncy	0.0000E+ 00	0	Off	0.0000E+ 00	0	None
12	Off	1	Frequ ncy	0.0000E+ 00	0	Off	0.0000E+ 00	0	None

The numbers appear in the file exactly as they appear onscreen. If it says 11.454 GHz onscreen, then in the file it is 11.454E+09.

The metadata header is very similar to the metadata used in the trace data .csv files. See Trace File Contents. The only new information concerns the 1-of-N fields in the marker table itself.

Peak Table

This section discusses the Peak Table Meas Results file format.

Imagine that, at the point where a Marker Table Meas Result is requested, the following screen is showing:

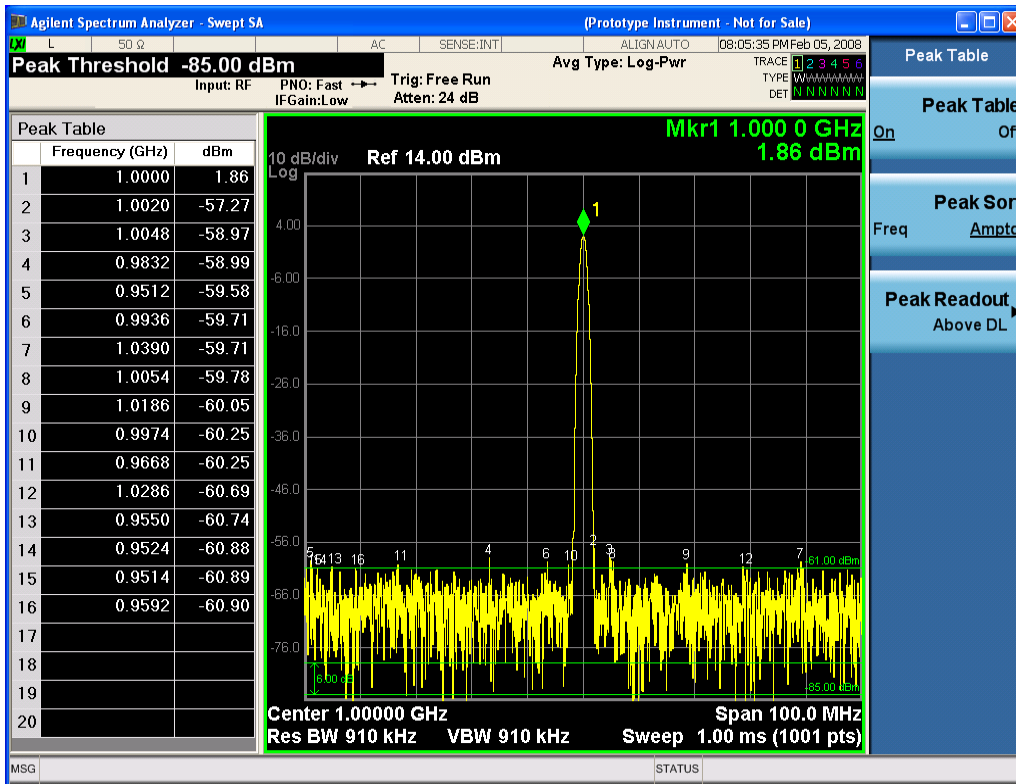

Then the Meas Results file, when opened, would show the header data (the same as for the Marker Table except that the Result Type is Peak Table) ending with a few fields of specific interest to Peak Table users:

- Peak Threshold
- Peak Threshold State (On|Off)
- Peak Excursion
- Peak Excursion State (On|Off)
- Display Line
- Peak Readout (All|AboveDL|BelowDL)
- Peak Sort (Freq|Amptd)

These fields are then followed by the data for the Peak Table itself.

Note that the label for the Frequency column changes to Time in 0 span.

Here is what the table for the above display looks like:

MeasurementResult	
Swept SA	
A.01.40_R0017	N9020A
526 B25 PFR P26 EA3	1

Result Type	Peak Table
Ref Level	0
Number of Points	1001
Sweep Time	0.066266667
Start Frequency	10000000
Stop Frequency	26500000000
Average Count	0
Average Type	LogPower(Video)
RBW	3000000
RBW Filter	Gaussian
RBW Filter BW	3dB
VBW	3000000
Sweep Type	Swept
X Axis Scale	Lin
PreAmp State	Off
PreAmp Band	Low
Trigger Source	Free
Trigger Level	1.2
Trigger Slope	Positive
Trigger Delay	1.00E-06
Phase Noise Optimization	Fast
Swept If Gain	Low
FFT If Gain	Autorange
RF Coupling	AC
FFT Width	411900
Ext Ref	10000000
Input	RF
RF Calibrator	Off
Attenuation	10
Ref Level Offset	0
External Gain	0
X Axis Units	Hz
Y Axis Units	dBm
Peak Threshold	-85
Peak Threshold State	On
Peak Excursion	6
Peak Excursion State	On

Display Line	-61	
Peak Readout	AboveDL	
Peak Sort	Amptd	
DATA		
Peak	Frequency	Amplitude
1	1.0000E+06	1.86
2	1.0020E+06	-57.27
3	1.0048E+06	-58.97
4	9.8320E+05	-58.99
5	9.5120E+05	-59.58
6	9.9360E+05	-59.71
7	1.0390E+06	-59.71
8	1.0054E+06	-59.78
9	1.1086E+06	-60.05
10	9.9740E+05	-60.25
11	9.6680E+05	-60.25
12	1.0286E+06	-60.69
13	9.5500E+05	-60.74
14	9.5240E+05	-60.88
15	9.5140E+05	-60.89
16	9.5920E+05	-60.90
17		
18		
19		
20		

Spectrogram

This section discusses the Spectrogram Results file format. The Spectrogram choice only appears if option EDP is licensed.

The Spectrogram results are the same as a Trace data export, except that instead of having just one trace's data, all 300 traces appear one after the other.

.

Each trace has its own data mark; the data for Spectrogram Trace 0 follows the row marked DATA, the data for Spectrogram Trace 1 follows the row marked DATA1, for Spectrogram Trace 2 follows the row marked DATA2, and so on.

Each DATA row has a timestamp in the second column (as of firmware revision A.11.01). So, for example, if Trace 0 had a relative start time of 1729.523 sec, then the first DATA row would look like this:

DATA,1729.523

And if Trace 13 had a relative start time of 100.45 sec, then the fourteenth data row would look like:

DATA13,100.453

To find the absolute time for the relative timestamps of each trace, the last row before the first DATA row gives the absolute start time of the Spectrogram, in the form YYYYMMDDHHMMSS

So, for example, if the absolute start time is 13:23:45:678 on January 30, 2012, this row would look like:

Start Time,20120130132345678

NOTE:

NOTE The resolution of the absolute time stored is 1 ms, which matches up with the fact that the fastest sweep time is also 1 ms. However, there is no specification for the absolute accuracy of the clock in the analyzer, nor is there any facility provided to allow the user to set this time to any particular degree of accuracy.

Traces that have not yet been filled in the Spectrogram display are empty; there is no DATA header for them. The file ends after the last non-empty trace.

Imagine that, at the point where a Spectrogram Meas Result is requested, the following screen is showing:



For the purpose of this example, we have set the Average/Hold Number to 10, thus we have only traces 0 thru 10. The Spectrogram was started at 02:28:08:700 pm on April 25, 2012 (that is, 700 ms after 2:28:08 pm), although the screen dump itself shows a different time, as it was taken ten minutes after the Spectrogram data. Trace 0 is showing a start time of 5.30 seconds, meaning 5.3 seconds after the Spectrogram started (trace 10 has a start time of 0, as it was the first trace taken but has now rolled up into the tenth trace slot).

The Meas Results file, when opened, shows the header data and ten traces of trace data. Below is an extract from the result file for the above display. Note the start time of 20120425142808700 showing in the last row before the first DATA row, and the relative time of 5.299231048 showing in the first DATA row:

Result Type	Spectrogram
MeasResult	
Swept SA	
A.11.00.01	N9020A
F03 F07 F13 F26 ALL ALV B1C B1X B25 B2X B40 BAB BBA CR3 CRP DP2 DRD EA3 EDP EMC EP1 ERC ESC ESP EXM FSA HBA K03 LFE MPB P03 P08 P13 P26 PFR RTL RTS S40 SB1 SEC SM1 UK6 YAS YAV	1
Segment	0
Number of Points	1001
Sweep Time	0.523333333
Start Frequency	5999984415
Stop Frequency	6000009415
Average Count	0
Average Type	LogPower(Video)
RBW	240
RBW Filter	Gaussian
RBW Filter BW	3dB
VBW	240
Sweep Type	Swept
X Axis Scale	Lin
PreAmp State	Off
PreAmp Band	Low
Trigger Source	Free
Trigger Level	1.2
Trigger Slope	Positive
Trigger Delay	0
Phase Noise Optimization	Wide
Swept If Gain	Low

Result Type	Spectrogram
FFT If Gain	Autorange
RF Coupling	AC
FFT Width	411900
Ext Ref	10000000
Input	RF
RF Calibrator	Off
Attenuation	14
Ref Level Offset	0
External Gain	0
Trace Type	Clearwrite
Detector	Normal
Trace Math	Off
Trace Math Oper1	Trace5
Trace Math Oper2	Trace6
Trace Math Offset	0
Trace Name	Trace1
X Axis Units	Hz
Y Axis Units	dBm
Start Time	20120425142808700
DATA	5.299231048
5999984415	-76.34749519
5999984440	-77.28097006
5999984465	-75.32317869
5999984490	-73.64417681
5999984515	-72.67154604

o
o
o

6000009315	-77.94423277
6000009340	-79.51829697
6000009365	-78.46108961
6000009390	-78.46108957
6000009415	-76.59570596
DATA2	4.708697055

5999984415	-80.98197882
5999984440	-80.98197879
5999984465	-75.83142132
5999984490	-74.02712079
5999984515	-73.57213005

○
○
○

6000009315	-75.9183103
6000009340	-79.53787488
6000009365	-78.82602191
6000009390	-78.82602188
6000009415	-76.37486709
DATA10	0
5999984415	-75.56751112
5999984440	-75.76485645
5999984465	-76.67718717
5999984490	-78.79238489
5999984515	-83.72680212

○
○
○

6000009315	-71.3942461
6000009340	-72.28308332
6000009365	-73.92684489
6000009390	-75.45548832
6000009415	-75.17904815

Capture Buffer

This function allows you to store captured data for reuse in demod measurements using 'Save/Recall' functionality for 'Capture Buffer'. (This function is enabled for 'Code Domain' and 'Modulation Accuracy' measurements ONLY)

'Capture Buffer' is saved and loaded as IQ Data with properties which show Sample Rate, Length, IF BW, etc.

Use-Case are as followings;

Use Capture Buffer to perform analysis of the same captured data using 'Code Domain' and 'Modulation Accuracy' measurements, or to playback previously saved captured data.

Key Path	Save, Data
Mode	CDMA2000
Example	MMEM:STOR:CAPT "MyCaptureData.bin" This stores the capture data in the file MyCaptureData.bin in the default directory.
Dependencies	Capture buffer functionality is only available for Code Domain and Modulation Accuracy measurement. In other measurements, this key is grayed out.
Initial S/W Revision	Prior to A.02.00

Save As . . .

When you press "Save As", the analyzer brings up a Windows dialog and a menu entitled "**Save As.**" This menu allows you to navigate to the various fields in the Windows dialog without using a keyboard or mouse. The Tab and Arrow keys can also be used for dialog navigation.

See "[To File . . .](#)" on page 2070 in Save, State for a full description of this dialog and menu.

The default path for saving files is:

For all of the Trace Data Files:

My Documents\<<mode name>\data\traces

For all of the Limit Data Files:

My Documents\<<mode name>\data\limits

For all of the Measurement Results Data Files:

My Documents\<<mode name>\data\<<measurement name>\results

For all of the Capture Buffer Data Files:

My Documents\<<mode name>\data\captureBuffer

Key Path	Save, Data
Mode	All
Notes	The key location is mode-dependent and will vary. Brings up the Save As dialog for saving a <mode specific> Save Type. The save is performed immediately and does not wait until the measurement is complete.
Initial S/W Revision	Prior to A.02.00

Screen Image

Pressing Screen Image accesses a menu of functions that enable you to specify a format and location for the saved screen image. It brings up a menu that allows you to specify the color scheme of the Screen Image (Themes) or navigate to the Save As dialog to perform the actual save.

Screen Image files contain an exact representation of the analyzer display. They cannot be loaded back onto the analyzer, but they can be loaded into your PC for use in many popular applications.

The image to be saved is actually captured when the Save front panel key is pressed, and kept in temporary storage to be used if you ask for a Screen Image save. When the Screen Image key is pressed, a "thumbnail" of the captured image is displayed, as shown below:

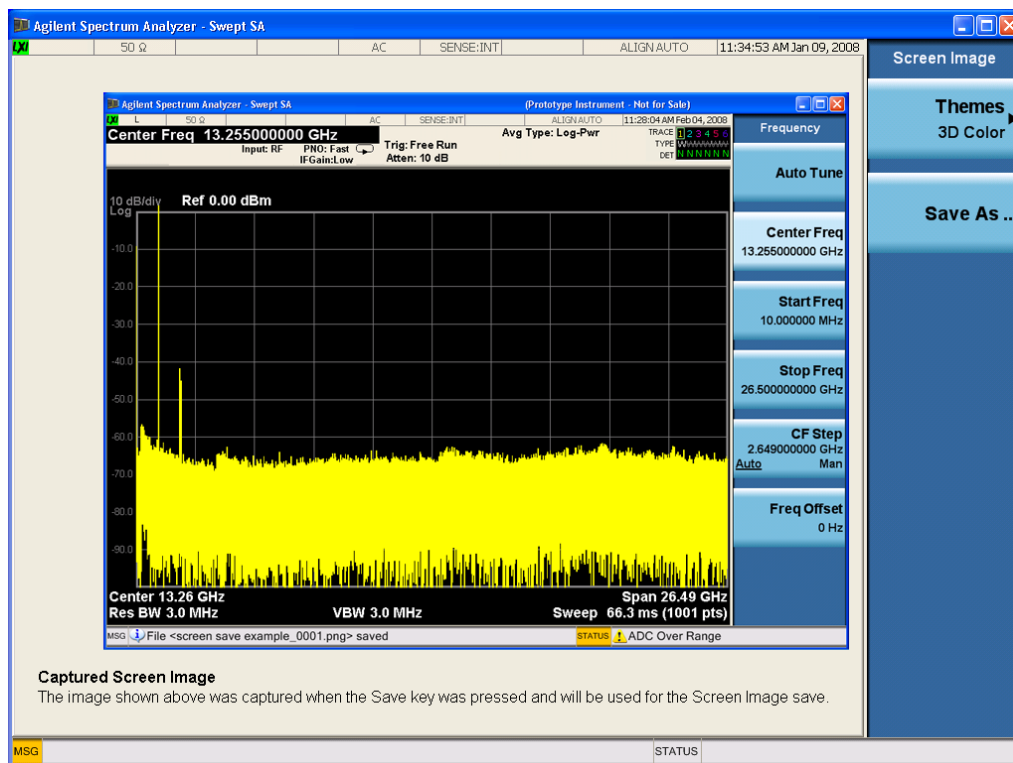

When you continue on into the Save As menu and complete the Screen Image save, the image depicted in the thumbnail is the one that gets saved, showing the menus that were on the screen before going into the Save menu. The save is performed immediately and does not wait until the measurement is complete.

After you have completed the save, the Quick Save front-panel key lets you quickly repeat the last save performed, using an auto-named file, with the current screen data.

NOTE

For versions previous to A.01.55, if you initiate a screen image save by navigating through the Save menus, the image that is saved will contain the Save menu softkeys, not the menu and the active function that were on the screen when you first pressed the Save front panel key.

Key Path	Save
Mode	All

Remote Command	:MMEMory:STORe:SCReen <filename>
Example	:MMEM:STOR:SCR "myScreen.png" This stores the current screen image in the file MyScreenFile.png in the default directory.
Initial S/W Revision	Prior to A.02.00

Themes

Accesses a menu of functions that enable you to choose the theme to be used when saving the screen image.

The **Themes** option is the same as the **Themes** option under the **Display** and **Page Setup** dialogs. It allows you to choose between themes to be used when saving the screen image.

Key Path	Save, Screen Image
Remote Command	:MMEMory:STORe:SCReen:THEMe TDColor TDMonochrome FCOLor FMONochrome :MMEMory:STORe:SCReen:THEMe?
Example	:MMEM:STOR:SCR:THEM TDM
Preset	3D Color; Is not part of Preset, but is reset by Restore Misc Defaults or Restore System Defaults All and survives subsequent running of the modes.
Readback	3D Color 3D Mono Flat Color Flat Mono
Backwards Compatibility Notes	In ESA and PSA we offer the choice of "Reverse Bitmap" or "Reverse Metafile" when saving screen images. This is much like the "Flat Color" theme available in X-Series. Also, if you selected Reverse Bitmap AND a black & white screen image, that would be much like "Flat Monochrome". In other words, each of the X-Series themes has a similar screen image type in ESA/PSA. But they are not identical.
Initial S/W Revision	Prior to A.02.00

3D Color

Selects a standard color theme with each object filled, shaded and colored as designed.

Key Path	Save, Screen Image, Themes
Example	MMEM:STOR:SCR:THEM TDC
Readback	3D Color
Initial S/W Revision	Prior to A.02.00

3D Monochrome

Selects a format that is like 3D color but shades of gray are used instead of colors.

Key Path	Save, Screen Image, Themes
Example	MMEM:STOR:SCR:THEM TDM
Readback	3D Mono
Initial S/W Revision	Prior to A.02.00

Flat Color

Selects a format that is best when the screen is to be printed on an ink printer.

Key Path	Save, Screen Image, Themes
Example	MMEM:STOR:SCR:THEM FCOL
Readback	Flat Color
Initial S/W Revision	Prior to A.02.00

Flat Monochrome

Selects a format that is like Flat Color. But only black is used (no colors, not even gray), and no fill.

Key Path	Save, Screen Image, Themes
Example	MMEM:STOR:SCR:THEM FMON
Readback	Flat Mono
Initial S/W Revision	Prior to A.02.00

Save As...

When you press "Save As", the analyzer brings up a Windows dialog and a menu entitled "**Save As.**" This menu allows you to navigate to the various fields in the Windows dialog without using a keyboard or mouse. The Tab and Arrow keys can also be used for dialog navigation.

See "[To File . . .](#)" on page 2070 in Save, State for a full description of this dialog and menu.

The default path for Screen Images is

My Documents\`<mode name>`\screen.

where `<mode name>` is the parameter used to select the mode with the INST:SEL command (for example, SA for the Spectrum Analyzer).

Key Path	Save, Screen Image
Notes	Brings up Save As dialog for saving a Screen Image Save Type
Initial S/W Revision	Prior to A.02.00

Single (Single Measurement/Sweep)

Sets the analyzer for Single measurement operation. The single/continuous state is Meas Global, so the setting will affect all the measurements. If you are Paused, pressing Single does a Resume.

See "[More Information](#)" on page 1596

Key Path	Front-panel key
Example	:INIT:CONT OFF
Notes	See Cont key description.
Backwards Compatibility Notes	<p>For Spectrum Analysis mode in ESA and PSA, the Single hardkey and the INITiate:IMM switched from continuous measurement to single measurement and restarted sweeps and averages (displayed average count reset to 1), but did not restart Max Hold and Min Hold. In the X-Series, the Single hardkey and the INITiate:IMM command initiate a sweep/ measurement/ average sequence/hold sequence including MaxHold and MinHold.</p> <p>For Spectrum Analysis mode in ESA and PSA, the Single hardkey restarted the sweep regardless of whether or not you were in an active sweep or sweep sequence. In the X-Series, Restart does this but Single only restarts the sweep or sweep sequence if you are in the idle state.</p> <p>INIT[:IMM] in ESA & PSA Spectrum Analysis Mode does an implied ABORT. In some other PSA Modes, INIT[:IMM] is ignored if not in the idle state. . The X-Series follows the ESA/PSA SA Mode model, which may cause some Modes to have compatibility problems.</p>
Initial S/W Revision	Prior to A.02.00

More Information

See "[Restart](#)" on page 2067 for details on the INIT:IMMEDIATE (Restart) function.

If you are already in single sweep, the INIT:CONT OFF command has no effect.

If you are already in Single Sweep, then pressing the Single key in the middle of a sweep does not restart the sweep or sequence. Similarly, pressing the Single key does not restart the sweep or sequence if the sweep is not in the idle state (for example, if you are taking a very slow sweep, or the analyzer is waiting for a trigger). Instead, it results in a message. "Already in Single, press Restart to initiate a new sweep or sequence". Even though pressing the Single key in the middle of a sweep does not restart the sweep, sending INIT:IMMEDIATE does reset it.

To take one more sweep without resetting the average count, increment the average count by 1, by pressing the step up key while **Average/Hold Number** is the active function, or sending the remote command CALC:AVER:TCON UP.

Source

Opens a menu of keys that access various source configuration menus and settings. In the test set, pressing this key also causes the central view area to change and display the Source Control Main view.

Key Path	Front-panel key
----------	-----------------

RF Output

This parameter sets the source RF power output state.

Key Path	Source
Remote Command	:OUTPut[:EXTernal][:STATe] ON OFF 1 0 :OUTPut[:EXTernal][:STATe]?
Example	OUTP OFF OUTP?
Notes	<p>The EXTERNAL node is shown in RD text so the SCPI remains the same between internal and external source control. However, for EXT we do not wish to document this node to the customer since we are controlling the internal source rather than the external source.</p> <p>This setting is for the independent mode and has no effect on the "List Sequencer" on page 2168. If the "Sequencer" on page 2168 is set to ON, the list sequencer controls the source output and this key will be grayed-out. And this setting will be none-forceful grey out on front panel to indicate out-of-scope. Non-forceful means user still can change this setting by SCPI but cannot change on front panel. When set to OFF will make source leave list sequencer and this setting will be black out and take effect immediately.</p> <p>When the RF Output is ON, an "RF" annunciator is displayed in the system settings panel. When the RF Output is turned Off, the RF annunciator is cleared. If the "Sequencer" on page 2168 is set to ON, the "RF" annunciator will be replaced by "SEQ" in the system settings panel, indicating that the output is controlled by the list sequencer.</p>
Preset	Off
Range	On Off
Initial S/W Revision	A.05.00

Amplitude

Allows you to access the Amplitude sub-menu.

Key Path	Source
Notes	<p>The sub-menu under this button is for independent mode and has no effect on "List Sequencer" on page 2168. If the "Sequencer" on page 2168 is set to ON, the list sequencer controls the source output and this key will be grayed-out on front panel to indicate out-of-scope. When you set "Sequencer" on page 2168 to Off will make source leave list sequencer and this button will be black out.</p>
Initial S/W Revision	A.05.00

RF Power

Allows you to adjust the power level of the source using the numeric keypad, step keys, or RPG. Pressing any digit, 0 through 9, on the numeric keypad brings up the unit terminator.

Please refer to the "[RF Power Range](#) " on page 1599 table below for the valid ranges.

Key Path	Source, Amplitude
Remote Command	:SOURce:POWer[:LEVel][:IMMediate][:AMPLitude] <ampl> :SOURce:POWer[:LEVel][:IMMediate][:AMPLitude]?
Example	:SOUR:POW -100 dBm
Notes	<p>Amplitude corrections can be specified for use with the source. In the event of amplitude corrections being applied, the valid ranges for the RF power do not change dependant on the current amplitude correction setting. If the combination of RF power + amplitude correction is higher or lower than the source output range, the Source Unleveled bit is set and the "Source Unleveled" indicator will appear on status panel to indicate that the source cannot maintain the output power that has been requested.</p> <p>When signal generator is unable to maintain the requested output level, the "Source Unleveled" indicator will appear on status panel. When the source output setting is restored to the normal range, the "Source Unleveled" is removed from status panel.</p> <p>Internal source has list sequence mode, which comprises of several steps which contain separate output power, frequency and waveform etc. When the source list sequence playing is complete, the last step keeps playing, and user can use this command to change the list sequence last step's output power.</p> <p>The multiport adapter RFIO TX ports and GPS ports cannot ensure power accuracy when power setting is lower than -130dBm, this power setting value is defined by the sum of RF Power setting and related amplitude correction value. But user settable value could be lower than this limit. When application detected there exists power setting lower than -130dBm on MPA RFIO TX ports, then popup warning message . When application detected there exists power setting lower than -130dBm on MPA GPS ports, then popup warning message . This is only warning message, and check is performed when RF is ON.</p>
Notes	The Min and Max value here defined UI settable amplitude range. This range is larger than actual amplitude range with level accuracy defined in spec.
Dependencies	The RF power is dependent on the RF output port and frequency, such that the current frequency and selected output port determine the valid range of power values.
Preset	-100 dBm
Min	The range of values depends on the current frequency and selected RF output port. Please refer to the " RF Power Range " on page 1599 table below for the valid ranges.
Max	The range of values depends on the current frequency and selected RF output port. Please refer to the " RF Power Range " on page 1599 table below for the valid ranges.
Initial S/W Revision	A.05.00

All other models:

RF Power Range

RF Output Port	Frequency Range	Min Output Power	Max Output Power
High Power RF Out	10 MHz \leq f \leq 6 GHz	-150 dBm	20 dBm
RFIO 1 & RFIO 2	10 MHz \leq f \leq 6 GHz	-150 dBm	0 dBm
GPS (Note2)	10 MHz \leq f \leq 6 GHz	-150 dBm	0 dBm

Note: This is the UI power range, it's larger than actual spec.

Note2: GPS port is on the multiport adapter, or E6607C which has embedded MPA.

M9420A:

RF Power Range

RF Output Port	Frequency Range	Min Output Power	Max Output Power without Option "1EA"	Max Output Power with Option "1EA"
RF Output	60 MHz \leq f \leq 6 GHz	-150 dBm	10 dBm	18 dBm
RFHD	60 MHz \leq f \leq 6 GHz	-150 dBm	10 dBm	15 dBm
RFFD	60 MHz \leq f \leq 6 GHz	-150 dBm	0 dBm	0 dBm

Set Reference Power

This key allows you to set the power reference. Pressing this key turns the power reference state to ON, sets the reference power value to the current RF output power, maintains this power at the RF output, and sets the displayed power to 0.00 dB. All subsequent RF power values entered under Source>Amplitude>RF Power are interpreted as being relative to this reference power.

When you use a power reference, the signal generator outputs an RF power that is set relative to the reference power by the value entered under Source>Amplitude>RF Power as follows:

Output power = reference power – entered power

Where:

reference power equals the original RF Power entered under Source>Amplitude>RF Power and set as the reference power

entered power equals a new value entered under Source>Amplitude>Amptd Offset

In addition, the displayed power value is the same as a new value entered under Source>Amplitude>RF Power.

NOTE

If Power Ref is set to ON with a reference value set, entering a value under Source>Amplitude>RF Power and pressing Set Reference Power will add that value to the existing Power Ref value.

If you wish to change the reference power value to a new value entered under Source>Amplitude>RF Power, first you must set Power Ref to OFF and then press Set Reference Power.

Key Path	Source, Amplitude
Dependencies	This key is unavailable, and is grayed out when the "List Sequencer" on page 2168 is turned ON.
Initial S/W Revision	A.05.00

Power Ref

This key allows you to toggle the state of the power reference.

When you use a power reference, the signal generator outputs an RF power that is set relative to the reference power by the value entered under Source>Amplitude>RF Power as follows:

Output power = reference power + entered power

Where:

reference power equals the original RF Power entered under Source>Amplitude>RF Power and set as the reference power

entered power equals a new value entered under Source>Amplitude>Amptd Offset

For more information on Reference Frequency refer to ["Set Reference Power " on page 2099](#)

Key Path	Source, Amplitude
Remote Command	:SOURce:POWer:REFerence <ampl> :SOURce:POWer:REFerence? :SOURce:POWer:REFerence:STATe OFF ON 0 1 :SOURce:POWer:REFerence:STATe?
Example	:SOUR:POW:REF 0.00 dBm :SOUR:POW:REF:STATe ON
Dependencies	This setting is unavailable and is grayed out when the "List Sequencer" on page 2168 is turned ON.
Couplings	This value is coupled to the "Set Reference Power " on page 2099 key such that pressing the Set Reference Power key updates the reference power with the current output power.
Preset	0.00 dBm OFF
Min	-125.00 dBm
Max	10.00 dBm
Initial S/W Revision	A.05.00

Amptd Offset

Allows you to specify the RF output power offset value.

When the amplitude offset is set to zero (0) and you set a new offset value (positive or negative), the displayed amplitude value will change as follows and the RF output power will not change:

Displayed value = output power + offset value

Where:

output power equals the original RF Power entered under Source>Amplitude>RF Power

offset value equals the value entered under Source>Amplitude>Amptd Offset

When the amplitude offset is set to a value other than zero (0) and you enter a new RF power value under Source>Amplitude>RF Power, the displayed power will be the same as the value entered and the RF output power will be equal to the value entered minus the offset value as follows:

Output power = entered power – offset power

Displayed Power = output power + offset power

Displayed power = entered power

Where:

entered power equals the amplitude entered under Source>Amplitude>RF Power

offset power equals the value previously entered and set under Source>Amplitude>Amptd Offset

Key Path	Source, Amplitude
Remote Command	:SOURce:POWer[:LEVel][:IMMediate]:OFFSet <rel_ampl> :SOURce:POWer[:LEVel][:IMMediate]:OFFSet?
Example	:SOUR:POW:OFFS 0.00 dB
Dependencies	This setting is unavailable, and is grayed out when the List Sequencer is turned ON.
Preset	0.00 dB
Min	-200.00 dB
Max	200.00 dB
Initial S/W Revision	A.05.00

Modulation

Allows you to toggle the state of the modulation.

Key Path	Source
Remote Command	:OUTPut:MODulation[:STATe] ON OFF 1 0 :OUTPut:MODulation[:STATe]?
Example	:OUTP:MOD OFF
Notes	This setting is for independent mode and has no effect on " List Sequencer " on page 2168. If the " Sequencer " on page 2168 is set to ON, the list sequencer controls the source output and this key will be grayed-out. And this setting will be none-forceful grey out on front panel to indicate out-of-scope. Non-forceful means user still can change this setting by SCPI but cannot change manually on front panel. When set to Off will make source leave list sequencer and this setting will be black out and take effect immediately. When the Modulation is ON, the "MOD" annunciator is displayed in the system settings panel. When the Modulation is turned Off, the "MOD" annunciator is cleared. If the

	"Sequencer" on page 2168 is set to ON, the "MOD" annunciator will be replaced by "SEQ" in the system settings panel indicating that the output is controlled by list sequencer.
Preset	Off
Range	On Off
Initial S/W Revision	A.05.00

Frequency

Allows you to access the Frequency sub-menu.

Key Path	Source
Notes	The sub-menu under this button is for independent mode and has no effect on "List Sequencer" on page 2168. If the "Sequencer" on page 2168 is set to ON, the list sequencer controls the source output and this key will be grayed-out. And this button will be grey out on front panel to indicate out-of-scope. When set to Off will make source leave list sequencer and this button will be black out.
Initial S/W Revision	A.05.00

Frequency

Allows you to set the RF Output Frequency. You can adjust the frequency of the source using the numeric keypad, step keys, or RPG. Pressing any digit, 0 through 9, on the numeric keypad brings up the unit terminator.

Key Path	Source, Frequency
Remote Command	:SOURce:FREQuency[:CW] <freq> :SOURce:FREQuency[:CW]?
Example	:SOUR:FREQ 1.00 GHz
Notes	Internal source has list sequence mode, which comprises of several steps which contain separate output power, frequency and waveform etc. When the source list sequence playing is complete, the last step keeps playing, and user can use this command to change the list sequence last step's output frequency.
Couplings	The frequency value is coupled to the current channel band and number, such that updates to the band and number will update the frequency value to the corresponding absolute frequency.
Preset	1.00 GHz If license F1A or 5WC is present, the default Center Frequency should be 2.412GHz.
Min	10.00 MHz
Max	Hardware Dependant: Option 503 = 3.6 GHz Option 504 = 3.8 GHz Option 506 = 6.00 GHz For E6640A, if license 5WC is present, the frequency range should be limited to: 1.1GHz-1.7GHz,

2.4GHz–2.5GHz, 4.8GHz–6.0GHz. If the user-defined frequency is outside of range, UI will report an error message called "Settings conflict; Frequency is outside available range".

Initial S/W Revision A.05.00

Channel

The frequency of the source can be specified by a channel number of a given frequency band. This key allows you to specify the current channel number. For the appropriate range of channel numbers for a given frequency band, refer to the following tables: ["GSM/EDGE Channel Number Ranges" on page 1603](#), ["W-CDMA Channel Number Ranges" on page 1604](#), ["CDMA 2000 / 1xEVDO Channel Number Ranges" on page 1606](#), and ["LTE FDD Channel Number Ranges" on page 1608](#).

Key Path	Source, Frequency
Remote Command	:SOURce:FREQuency:CHANnels:NUMBer <int> :SOURce:FREQuency:CHANnels:NUMBer?
Example	:SOUR:FREQ:CHAN:NUMB 1
Notes	This key is grayed out when the "Radio Standard" on page 2111 is set to NONE. This key is grayed out on E6630A.
Dependencies	This key is grayed out when the "Radio Standard" on page 2111 is set to NONE. This key is grayed out on E6630A.
Couplings	The channel number is coupled to the frequency value when the "Radio Standard" on page 2111 is not set to NONE. When the frequency value is changed, the channel number will increase or decrease to match the new frequency. If the frequency is not at an exact match for a channel number, the nearest channel number is displayed along with a greater than or less than sign to indicate the frequency is above or below the channel number.
Preset	1
Min	Please refer to the tables below for the valid ranges.
Max	Please refer to the tables below for the valid ranges.
Initial S/W Revision	A.05.00

GSM/EDGE Channel Number Ranges

Band	Link (Device)	Range	Frequency (MHz)
P-GSM	Uplink (MS)	$1 \leq n \leq 124$	$890.0 + 0.2*n$
	Downlink (BS)	$1 \leq n \leq 124$	$935.0 + 0.2*n$
E-GSM	Uplink (MS)	$0 \leq n \leq 124$	$890.0 + 0.2*n$
		$975 \leq n \leq 1023$	$890.0 + 0.2*(n-1024)$
	Downlink (BS)	$0 \leq n \leq 124$	$935.0 + 0.2*n$
		$975 \leq n \leq 1023$	$935.0 + 0.2*(n-1024)$

Band	Link (Device)	Range	Frequency (MHz)
DCS 1800	Uplink (MS)	$512 \leq n \leq 885$	$1710.200 + 0.20*(n-512)$
	Downlink (BS)	$512 \leq n \leq 885$	$1805.200 + 0.20*(n-512)$
PCS 1900	Uplink (MS)	$512 \leq n \leq 810$	$1850.200 + 0.2*(n-512)$
	Downlink (BS)	$512 \leq n \leq 810$	$1930.200 + 0.2*(n-512)$
R-GSM	Uplink (MS)	$0 \leq n \leq 124$	$890.0 + 0.2*n$
		$955 \leq n \leq 1023$	$890.0 + 0.2*(n-1024)$
	Downlink (BS)	$0 \leq n \leq 124$	$935.0 + 0.2*n$
		$955 \leq n \leq 1023$	$935.0 + 0.2*(n-1024)$
GSM 450	Uplink (MS)	$256 \leq n \leq 293$	$450.6 + 0.2*(n-259)$
	Downlink (BS)	$256 \leq n \leq 293$	$460.6 + 0.2*(n-259)$
GSM 480	Uplink (MS)	$306 \leq n \leq 340$	$479.000 + 0.20*(n-306)$
	Downlink (BS)	$306 \leq n \leq 340$	$489.000 + 0.20*(n-306)$
GSM 850	Uplink (MS)	$128 \leq n \leq 251$	$824.200 + 0.20*(n-128)$
	Downlink (BS)	$128 \leq n \leq 251$	$869.200 + 0.20*(n-128)$
GSM 700	Uplink (MS)	$438 \leq n \leq 516$	$777.200 + 0.20*(n-438)$
	Downlink (BS)	$438 \leq n \leq 516$	$747.200 + 0.20*(n-438)$
T-GSM810	Uplink (MS)	$350 \leq n \leq 425$	$806.0 + 0.20*(n-350)$
	Downlink (BS)	$350 \leq n \leq 425$	$851.0 + 0.20*(n-350)$

W-CDMA Channel Number Ranges

Band	Link (Device)	Range	Frequency (MHz)
Band I	Downlink	$10562 \leq n \leq 10838$	$n \div 5$
	Uplink	$9612 \leq n \leq 9888$	$n \div 5$
Band II	Downlink	$412 \leq n \leq 687$	$n \div 5 + 1850.1$
		$9662 \leq n \leq 9938$	$n \div 5$
	Uplink	$12 \leq n \leq 287$	$n \div 5 + 1850.1$
		$350 \leq n \leq 425$	$n \div 5$
Band III	Downlink	$1162 \leq n \leq 1513$	$n \div 5 + 1575$
	Uplink	$937 \leq n \leq 1288$	$n \div 5 + 1525$
Band IV	Downlink	$537 \leq n \leq 1738$	$n \div 5 + 1805$
		$1887 \leq n \leq 2087$	$n \div 5 + 1735.1$
	Uplink	$1312 \leq n \leq 1513$	$n \div 5 + 1450$
		$1662 \leq n \leq 1862$	$n \div 5 + 1380.1$
Band V	Downlink	$1007 \leq n \leq 1087$	$n \div 5 + 670.1$
		$4357 \leq n \leq 4458$	$n \div 5$

Band	Link (Device)	Range	Frequency (MHz)
	Uplink	$782 \leq n \leq 862$	$n \div 5 + 670.1$
		$4132 \leq n \leq 4233$	$n \div 5$
Band VI	Downlink	$1037 \leq n \leq 1062$	$n \div 5 + 670.1$
		$4387 \leq n \leq 4413$	$n \div 5$
	Uplink	$812 \leq n \leq 837$	$n \div 5 + 670.1$
		$4162 \leq n \leq 4188$	$n \div 5$
Band VII	Downlink	$2237 \leq n \leq 2563$	$n \div 5 + 2175$
		$2587 \leq n \leq 2912$	$n \div 5 + 2105.1$
	Uplink	$2012 \leq n \leq 2338$	$n \div 5 + 2100$
		$2362 \leq n \leq 2687$	$n \div 5 + 2030.1$
Band VIII	Downlink	$2937 \leq n \leq 3088$	$n \div 5 + 340$
	Uplink	$2712 \leq n \leq 2863$	$n \div 5 + 340$
Band IX	Downlink	$9237 \leq n \leq 9387$	$n \div 5$
	Uplink	$8762 \leq n \leq 8912$	$n \div 5$
Band X	Downlink	$3112 \leq n \leq 3388$	$n \div 5 + 1490$
		$3412 \leq n \leq 3687$	$n \div 5 + 1430.1$
	Uplink	$2887 \leq n \leq 3163$	$n \div 5 + 1135$
		$3187 \leq n \leq 3462$	$n \div 5 + 1075.1$
Band XI	Downlink	$3712 \leq n \leq 3812$	$n \div 5 + 736$
	Uplink	$3487 \leq n \leq 3587$	$n \div 5 + 733$
Band XII	Downlink	$3837 \leq n \leq 3903$	$n \div 5 - 37$
		$3927 \leq n \leq 3992$	$n \div 5 - 54.9$
	Uplink	$3612 \leq n \leq 3678$	$n \div 5 - 22$
		$3702 \leq n \leq 3767$	$n \div 5 - 39.9$
Band XIII	Downlink	$4017 \leq n \leq 4043$	$n \div 5 - 55$
		$4067 \leq n \leq 4092$	$n \div 5 - 64.9$
	Uplink	$3792 \leq n \leq 3818$	$n \div 5 + 21$
		$3702 \leq n \leq 3767$	$n \div 5 - 39.9$
Band XIV	Downlink	$4117 \leq n \leq 4143$	$n \div 5 - 63$
		$4167 \leq n \leq 4192$	$n \div 5 - 72.9$
	Uplink	$3892 \leq n \leq 3918$	$n \div 5 + 12$
		$3942 \leq n \leq 3967$	$n \div 5 + 2.1$
Band XIX	Downlink	$712 \leq n \leq 763$	$n \div 5 + 735$
		$787 \leq n \leq 837$	$n \div 5 + 720.1$
	Uplink	$312 \leq n \leq 363$	$n \div 5 + 770$
		$387 \leq n \leq 437$	$n \div 5 + 755.1$

CDMA 2000 / 1xEVDO Channel Number Ranges

Band	Link (Device)	Range	Frequency (MHz)
US Cellular	Uplink (MS, reverse link)	$1 \leq N \leq 799$	$0.030 \times N + 825.000$
		$991 \leq N \leq 1023$	$0.030 \times (N - 1023) + 825.000$
		$1024 \leq N \leq 1323$	$0.030 \times (N - 1024) + 815.040$
	Downlink (BS, forward link)	$1 \leq N \leq 799$	$0.030 \times N + 870.000$
		$991 \leq N \leq 1023$	$0.030 \times (N - 1023) + 870.000$
		$1024 \leq N \leq 1323$	$0.030 \times (N - 1024) + 860.040$
US PCS	Uplink (MS, reverse link)	$0 \leq N \leq 1199$	$1850.000 + 0.050 \times N$
	Downlink (BS, forward link)	$0 \leq N \leq 1199$	$1930.000 + 0.050 \times N$
Japan Cellular Band	Uplink (MS, reverse link)	$1 \leq N \leq 799$	$0.0125 \times (N + 915.000)$
		$801 \leq N \leq 1039$	$0.0125 \times (N - 800) + 898.000$
		$1041 \leq N \leq 1199$	$0.0125 \times (N - 1040) + 887.000$
		$1201 \leq N \leq 1600$	$0.0125 \times (N - 1200) + 893.000$
	Downlink (BS, forward link)	$1 \leq N \leq 799$	$0.0125 \times (N + 860.000)$
		$801 \leq N \leq 1039$	$0.0125 \times (N - 800) + 843.000$
		$1041 \leq N \leq 1199$	$0.0125 \times (N - 1040) + 832.000$
		$1201 \leq N \leq 1600$	$0.0125 \times (N - 1200) + 838.000$
Korean PCS Band	Uplink (MS, reverse link)	$0 \leq N \leq 599$	$0.050 \times N + 1750.000$
	Downlink (BS, forward link)	$0 \leq N \leq 599$	$0.050 \times N + 1840.000$
NMT-450 Band	Uplink (MS, reverse link)	$1 \leq N \leq 400$	$0.025 \times (N - 1) + 450.000$
		$472 \leq N \leq 871$	$0.025 \times (N - 472) + 410.000$
		$1039 \leq N \leq 1473$	$0.020 \times (N - 1024) + 451.010$
		$1536 \leq N \leq 1715$	$0.025 \times (N - 1536) + 479.000$
		$1792 \leq N \leq 2016$	$0.020 \times (N - 1792) + 479.000$
	Downlink (BS, forward link)	$1 \leq N \leq 400$	$0.025 \times (N - 1) + 460.000$
		$472 \leq N \leq 871$	$0.025 \times (N - 472) + 420.000$
		$1039 \leq N \leq 1473$	$0.020 \times (N - 1024) + 461.010$
		$1536 \leq N \leq 1715$	$0.025 \times (N - 1536) + 489.000$
		$1792 \leq N \leq 2016$	$0.020 \times (N - 1792) + 489.000$
IMT-2000 Band	Uplink (MS, reverse link)	$0 \leq N \leq 1199$	$1920.000 + 0.050 \times N$
	Downlink (BS, forward link)	$0 \leq N \leq 1199$	$2100.000 + 0.050 \times N$
Upper 700 MHz Band	Uplink (MS, reverse link)	$0 \leq N \leq 240$	$776.000 + 0.050 \times N$
	Downlink (BS, forward link)	$0 \leq N \leq 240$	$746.000 + 0.050 \times N$

Band	Link (Device)	Range	Frequency (MHz)
	forward link)		
Secondary 800 MHz Band	Uplink (MS, reverse link)	$0 \leq N \leq 719$ $720 \leq N \leq 919$	$0.025 \times N + 806.000$ $0.025 \times (N - 720) + 896.000$
	Downlink (BS, forward link)	$0 \leq N \leq 719$ $720 \leq N \leq 919$	$0.025 \times N + 851.000$ $0.025 \times (N - 720) + 935.000$
2.5 GHz IMT Extension	Uplink (MS, reverse link)	$0 \leq N \leq 1399$	$2500.000 + 0.050 \times N$
	Downlink (BS, forward link)	$0 \leq N \leq 1399$	$2620.000 + 0.050 \times N$
US PCS 1.9 GHz	Uplink (MS, reverse link)	$0 \leq N \leq 1299$	$1850.000 + 0.050 \times N$
	Downlink (BS, forward link)	$0 \leq N \leq 1299$	$1930.000 + 0.050 \times N$
AWS	Uplink (MS, reverse link)	$0 \leq N \leq 899$	$1710.000 + 0.050 \times N$
	Downlink (BS, forward link)	$0 \leq N \leq 899$	$2100.000 + 0.050 \times N$
US 2.5 GHz	Uplink (MS, reverse link)	$140 \leq N \leq 1459$	$2495.000 + 0.050 \times N$
	Downlink (BS, forward link)	$140 \leq N \leq 1459$	$2617.000 + 0.050 \times N$
700 Public Safety	Uplink (MS, reverse link)	$0 \leq N \leq 240$	$787.000 + 0.050 \times N$
	Downlink (BS, forward link)	$0 \leq N \leq 240$	$757.000 + 0.050 \times N$
C2K Lower 700	Uplink (MS, reverse link)	$0 \leq N \leq 360$	$698.000 + 0.050 \times N$
	Downlink (BS, forward link)	$0 \leq N \leq 360$	$728.000 + 0.050 \times N$
400 Euro PAMR	Uplink (MS, reverse link)	$1 \leq N \leq 400$	$0.025 \times (N - 1) + 450.000$
		$472 \leq N \leq 871$	$0.025 \times (N - 472) + 410.000$
	Uplink (MS, reverse link)	$1536 \leq N \leq 1715$	$0.025 \times (N - 1536) + 479.000$
	Uplink (MS, reverse link)		
	Downlink (BS, forward link)	$1 \leq N \leq 400$	$0.025 \times (N - 1) + 460.000$
		$472 \leq N \leq 871$	$0.025 \times (N - 472) + 420.000$
	Downlink (BS, forward link)	$1536 \leq N \leq 1715$	$0.025 \times (N - 1536) + 489.000$
	Downlink (BS, forward link)		

Band	Link (Device)	Range	Frequency (MHz)
800 PAMR	Uplink (MS, reverse link)	$0 \leq N \leq 239$	$870.0125 + 0.025 \times N$
	Downlink (BS, forward link)	$0 \leq N \leq 239$	$915.0125 + 0.025 \times N$

LTE FDD Channel Number Ranges

The carrier frequency in the uplink and downlink is designated by the E-UTRA Absolute Radio Frequency Channel Number (EARFCN) in the range 0 – 65535. The relation between EARFCN and the carrier frequency in MHz for the downlink is given by the following equation, where FDL_low and NOffs-DL are given in table 5.4.4-1 and NDL is the downlink EARFCN.

$$FDL = FDL_low + 0.1(NDL - NOffs-DL)$$

The relation between EARFCN and the carrier frequency in MHz for the uplink is given by the following equation where FUL_low and NOffs-UL are given in table 5.4.4-1 and NUL is the uplink EARFCN.

$$FUL = FUL_low + 0.1(NUL - NOffs-UL)$$

Band	Downlink		Uplink			
	FDL_low (MHz)	NOffs-DL	Range of NDL	FUL_low (MHz)	NOffs-UL	Range of NUL
1		2110	0	0 - 599	1920	18000 - 18599
2		1930	600	600 - 1199	1850	18600 - 19199
3		1805	1200	1200 - 1949	1710	19200 - 19949
4		2110	1950	1950 - 2399	1710	19950 - 20399
5		869	2400	2400 - 2649	824	20400 - 20649
6		875	2650	2650 - 2749	830	20650 - 20749
7		2620	2750	2750 - 3449	2500	20750 - 20449
8		925	3450	3450 - 3799	880	21450 - 21799
9		1844.9	3800	3800 - 4149	1749.9	21800 - 22149
10		2110	4150	4150 - 4749	1710	22150 - 22749
11		1475.9	4750	4750 - 4949	1427.9	22750 - 22949

Band	Downlink	Uplink				
12	729	5010	5010 - 5179	699	23010	23010 - 23179
13	746	5180	5180 - 5279	777	23180	23180 - 23279
14	758	5280	5280 - 5379	788	23280	23280 - 23379
...						
17	734	5730	5730 - 5849	704	23730	23730 - 23849
18	860	5850	5850 - 5999	815	23850	23850 - 23999
19	875	6000	6000 - 6149	830	24000	24000 - 24149
20	791	6150	6150 - 6449	832	24150	24150 - 24449
21	1495.9	6450	6450 - 6599	1447.9	24450	24450 - 24599
...						
24	1525	7700	7700 - 8039	1626.5	25700	25700 - 26039
25	1930	8040	8040 - 8689	1850	26040	26040 - 26689
26	859	8690	8690 - 9039	814	26690	26690 - 27039
...						

Note: The channel numbers that designate carrier frequencies so close to the operating band edges that the carrier extends beyond the operating band edge shall not be used. This implies that the first 7, 15, 25, 50, 75 and 100 channel numbers at the lower operating band edge and the last 6, 14, 24, 49, 74 and 99 channel numbers at the upper operating band edge shall not be used for channel bandwidths of 1.4, 3, 5, 10, 15 and 20 MHz respectively.

LTE TDD Channel Number Ranges

The carrier frequency in the uplink and downlink is designated by the E-UTRA Absolute Radio Frequency Channel Number (EARFCN) in the range 0 – 65535. The relation between EARFCN and the carrier frequency in MHz for the downlink is given by the following equation, where FDL_low and NOffs-DL are given in table 5.4.4-1 and NDL is the downlink EARFCN.

$$FDL = FDL_low + 0.1(NDL - NOffs-DL)$$

The relation between EARFCN and the carrier frequency in MHz for the uplink is given by the following equation where FUL_low and NOffs-UL are given in table 5.4.4-1 and NUL is the uplink EARFCN.

$$FUL = FUL_low + 0.1(NUL - NOffs-UL)$$

Band	Downlink		Uplink		
	NOffs-DL	FDL_low (MHz)	FUL_low (MHz)	NOffs-UL	Range of NUL
33	1900	36000	36000 – 36199	1900	36000 – 36199
34	2010	36200	36200 – 36349	2010	36200 – 36349
35	1850	36350	36350 – 36949	1850	36350 – 36949
36	1930	36950	36950 – 37549	1930	36950 – 37549
37	1910	37550	37550 – 37749	1910	37550 – 37749
38	2570	37750	37750 – 38249	2570	37750 – 38249
39	1880	38250	38250 – 38649	1880	38250 – 38649
40	2300	38650	38650 – 39649	2300	38650 – 39649
41	2496	39650	39650 – 41589	2496	39650 – 41589
42	3400	41590	41590 – 43589	3400	41590 – 43589
43	3600	43590	43590 – 45589	3600	43590 – 45589

Note: The channel numbers that designate carrier frequencies so close to the operating band edges that the carrier extends beyond the operating band edge shall not be used. This implies that the first 7, 15, 25, 50, 75 and 100 channel numbers at the lower operating band edge and the last 6, 14, 24, 49, 74 and 99 channel numbers at the upper operating band edge shall not be used for channel bandwidths of 1.4, 3, 5, 10, 15 and 20 MHz respectively.

TDSCDMA Channel Number Ranges

1.28 Mcps TDD Option

No TX-RX frequency separation is required as Time Division Duplex (TDD) is employed. Each subframe consists of 7 main timeslots where all main timeslots (at least the first one) before the single switching point are allocated DL and all main timeslots (at least the last one) after the single switching point are allocated UL.

The nominal channel spacing is 1.6 MHz, but this can be adjusted to optimise performance in a particular deployment scenario.

The carrier frequency is designated by the UTRA absolute radio frequency channel number (UARFCN). The value of the UARFCN in the IMT2000 band is defined in the general case as follows:

$$N_t = 5 * F \quad 0.0 \text{ MHz} \leq F \leq 3276.6 \text{ MHz}$$

where F is the carrier frequency in MHz

Additional channels applicable to operation in the frequency band defined in sub-clause 5.2(d) are defined via the following UARFCN definition:

$$N_t = 5 * (F - 2150.1 \text{ MHz}) / 2572.5 \text{ MHz} \leq F \leq 2617.5 \text{ MHz}$$

UARFCN

1.28 Mcps TDD Option

The following UARFCN range shall be supported for each band:

**Table: UTRA Absolute Radio
Frequency Channel Number 1.28
Mcps TDD Option**

Frequency Band	Frequency Range	UARFCN Uplink and Downlink transmission
For operation in frequency band as defined in subclause 5.2 (a)	1900–1920 MHz	9504 to 9596
	2010–2025 MHz	10054 to 10121
For operation in frequency band as defined in subclause 5.2 (b)	1850–1910 MHz	9254 to 9546
	1930–1990 MHz	9654 to 9946
For operation in frequency band as defined in subclause 5.2 (c)	1910–1930 MHz	9554 to 9646
For operation in frequency band as defined in subclause 5.2 (d)	2570–2620 MHz	12854 to 13096
For operation in frequency band as defined in subclause 5.2 (e)	2300–2400 MHz	11504 to 11996
For operation in frequency band as defined in subclause 5.2 (f)	1880–1920 MHz	9404 to 9596

Radio Setup

Allows access to the sub-menus for selecting the radio standard and associated radio band. You can also set a frequency reference and offset.

This menu is greyed out when on E6630A. Radio band settings for GSM, cdma2000, and so on -- most of which are not actually supported in E6630A, which has three narrow frequency bands. So band settings are grayed out.

Key Path	Source, Frequency
Initial S/W Revision	A.05.00

Radio Standard

Allows access to the channel band sub-menus to select the desired radio standard. When you have selected the radio standard, you can then set an active channel band. The radio standard and the active

channel band allow you to use channel numbers to set frequency automatically.

Key Path	Source, Frequency, Radio Setup
Remote Command	:SOURce:FREQuency:CHANnels:BAND NONE PGSM EGSM RGSM DCS1800 PCS1900 TGSM810 GSM450 GSM480 GSM700 GSM850 BANDI BANDII BANDIII BANDIV BANDV BANDVI BANDVII BANDVIII BANDIX BANDX BANDXI BANDXII BANDXIII BANDXIV BANDXIX USCELL USPCS JAPAN KOREAN NMT IMT2K UPPER SECOND PAMR400 PAMR800 IMTEXT PCS1DOT9G AWS US2DOT5G PUBLIC LOWER BAND1 BAND2 BAND3 BAND4 BAND5 BAND6 BAND7 BAND8 BAND10 BAND11 BAND12 BAND13 BAND14 BAND17 BAND18 BAND19 BAND20 BAND21 BAND24 BAND25 BAND26 BAND27 BAND28 BAND29 BAND30 BAND31 BAND33 BAND34 BAND35 BAND36 BAND37 BAND38 BAND39 BAND40 BAND41 BAND42 BAND43 BAND44 BANDA BANDB BANDC BANDD BANDE BANDE :SOURce:FREQuency:CHANnels:BAND?
Example	:SOUR:FREQ:CHAN:BAND PGSM
Notes	Set this setting to "NONE" will grey out "Channel" on page 2103 Channel
Initial S/W Revision	A.05.00

None

Selects no radio standard for use. When you have selected the radio standard to NONE, you cannot use channel numbers to set frequency automatically. You will need to set the frequency manually.

Key Path	Source, Frequency, Radio Setup, Radio Standard
Initial S/W Revision	A.05.00

GSM/EDGE

Sets GSM/EDGE as the radio standard for use and accesses the GSM/EDGE specific channel band sub-menus.

Key Path	Source, Frequency, Radio Setup, Radio Standard
Initial S/W Revision	A.05.00

P-GSM

Selects P-GSM as the active channel band.

Key Path	Source, Frequency, Radio Setup, Radio Standard, GSM/EDGE
Example	:SOUR:FREQ:CHAN:BAND PGSM
Initial S/W Revision	A.05.00

E-GSM

Selects E-GSM as the active channel band.

Key Path	Source, Frequency, Radio Setup, Radio Standard, GSM/EDGE
Example	:SOUR:FREQ:CHAN:BAND EGSM
Initial S/W Revision	A.05.00

R-GSM

Selects R-GSM as the active channel band.

Key Path	Source, Frequency, Radio Setup, Radio Standard, GSM/EDGE
Example	:SOUR:FREQ:CHAN:BAND RGSM
Initial S/W Revision	A.05.00

DCS 1800

Selects DCS 1800 as the active channel band.

Key Path	Source, Frequency, Radio Setup, Radio Standard, GSM/EDGE
Example	:SOUR:FREQ:CHAN:BAND DCS1800
Initial S/W Revision	A.05.00

PCS 1900

Selects PCS 1900 as the active channel band.

Key Path	Source, Frequency, Radio Setup, Radio Standard, GSM/EDGE
Example	:SOUR:FREQ:CHAN:BAND PCS1900
Initial S/W Revision	A.05.00

GSM 450

Selects GSM 450 as the active channel band.

Key Path	Source, Frequency, Radio Setup, Radio Standard, GSM/EDGE
Example	:SOUR:FREQ:CHAN:BAND GSM450
Initial S/W Revision	A.05.00

GSM 480

Selects GSM 480 as the active channel band.

Key Path	Source, Frequency, Radio Setup, Radio Standard, GSM/EDGE
Example	:SOUR:FREQ:CHAN:BAND GSM480
Initial S/W Revision	A.05.00

GSM 850

Selects GSM 850 as the active channel band.

Key Path	Source, Frequency, Radio Setup, Radio Standard, GSM/EDGE
Example	:SOUR:FREQ:CHAN:BAND GSM850
Initial S/W Revision	A.05.00

GSM 700

Selects GSM 700 as the active channel band.

Key Path	Source, Frequency, Radio Setup, Radio Standard, GSM/EDGE
Example	:SOUR:FREQ:CHAN:BAND GSM700
Initial S/W Revision	A.05.00

T-GSM 810

Selects T-GSM 810 as the active channel band.

Key Path	Source, Frequency, Radio Setup, Radio Standard, GSM/EDGE
Example	:SOUR:FREQ:CHAN:BAND T-GSM810
Initial S/W Revision	A.05.00

WCDMA

Sets WCDMA as the radio standard for use and accesses the W-CDMA specific channel band sub-menus.

Key Path	Source, Frequency, Radio Setup, Radio Standard
Initial S/W Revision	A.05.00

Band I

Selects Band I as the active channel band.

Key Path	Source, Frequency, Radio Setup, Radio Standard, WCDMA
Example	:SOUR:FREQ:CHAN:BAND BANDI
Initial S/W Revision	A.05.00

Band II

Selects Band II as the active channel band.

Key Path	Source, Frequency, Radio Setup, Radio Standard, WCDMA
Example	:SOUR:FREQ:CHAN:BAND BANDII
Initial S/W Revision	A.05.00

Band III

Selects Band III as the active channel band.

Key Path	Source, Frequency, Radio Setup, Radio Standard, WCDMA
Example	:SOUR:FREQ:CHAN:BAND BANDIII
Initial S/W Revision	A.05.00

Band IV

Selects Band IV as the active channel band.

Key Path	Source, Frequency, Radio Setup, Radio Standard, WCDMA
Example	:SOUR:FREQ:CHAN:BAND BANDIV
Initial S/W Revision	A.05.00

Band V

Selects Band V as the active channel band.

Key Path	Source, Frequency, Radio Setup, Radio Standard, WCDMA
Example	:SOUR:FREQ:CHAN:BAND BANDV
Initial S/W Revision	A.05.00

Band VI

Selects Band VI as the active channel band.

Key Path	Source, Frequency, Radio Setup, Radio Standard, WCDMA
Example	:SOUR:FREQ:CHAN:BAND BANDVI
Initial S/W Revision	A.05.00

Band VII

Selects Band VII as the active channel band.

Key Path	Source, Frequency, Radio Setup, Radio Standard, WCDMA
Example	:SOUR:FREQ:CHAN:BAND BANDVII
Initial S/W Revision	A.05.00

Band VIII

Selects Band VIII as the active channel band.

Key Path	Source, Frequency, Radio Setup, Radio Standard, WCDMA
Example	:SOUR:FREQ:CHAN:BAND BANDVIII
Initial S/W Revision	A.05.00

Band IX

Selects Band IX as the active channel band.

Key Path	Source, Frequency, Radio Setup, Radio Standard, WCDMA
Example	:SOUR:FREQ:CHAN:BAND BANDIX
Initial S/W Revision	A.05.00

Band X

Selects Band X as the active channel band.

Key Path	Source, Frequency, Radio Setup, Radio Standard, WCDMA
Example	:SOUR:FREQ:CHAN:BAND BANDX
Initial S/W Revision	A.05.00

Band XI

Selects Band XI as the active channel band.

Key Path	Source, Frequency, Radio Setup, Radio Standard, WCDMA
Example	:SOUR:FREQ:CHAN:BAND BANDXI
Initial S/W Revision	A.05.00

Band XII

Selects Band XII as the active channel band.

Key Path	Source, Frequency, Radio Setup, Radio Standard, WCDMA
Example	:SOUR:FREQ:CHAN:BAND BANDXII
Initial S/W Revision	A.05.00

Band XIII

Selects band XIII as the active channel band.

Key Path	Source, Frequency, Radio Setup, Radio Standard, WCDMA
Example	:SOUR:FREQ:CHAN:BAND BANDXIII
Initial S/W Revision	A.05.00

Band XIV

Selects Band XIV as the active channel band.

Key Path	Source, Frequency, Radio Setup, Radio Standard, WCDMA
Example	:SOUR:FREQ:CHAN:BAND BANDXIV
Initial S/W Revision	A.05.00

LTE

Sets LTE FDD as the radio standard for use and accesses the LTE FDD specific channel band sub-menus..

Key Path	Source, Frequency, Radio Setup, Radio Standard
Initial S/W Revision	A.09.50

BAND 1

Selects BAND 1 as the band for the current step.

Key Path	Source, Frequency, Radio Setup, Radio Standard, LTE
----------	---

Example	:SOUR:FREQ:CHAN:BAND BAND1
Initial S/W Revision	A.09.50

BAND 2

Selects BAND 2 as the band for the current step.

Key Path	Source, Frequency, Radio Setup, Radio Standard, LTE
Example	:SOUR:FREQ:CHAN:BAND BAND2
Initial S/W Revision	A.09.50

BAND 3

Selects BAND 3 as the band for the current step.

Key Path	Source, Frequency, Radio Setup, Radio Standard, LTE
Example	:SOUR:FREQ:CHAN:BAND BAND3
Initial S/W Revision	A.09.50

BAND 4

Selects BAND 4 as the band for the current step.

Key Path	Source, Frequency, Radio Setup, Radio Standard, LTE
Example	:SOUR:FREQ:CHAN:BAND BAND4
Initial S/W Revision	A.09.50

BAND 5

Selects BAND 5 as the band for the current step.

Key Path	Source, Frequency, Radio Setup, Radio Standard, LTE
Example	:SOUR:FREQ:CHAN:BAND BAND5
Initial S/W Revision	A.09.50

BAND 6

Selects BAND 6 as the band for the current step.

Key Path	Source, Frequency, Radio Setup, Radio Standard, LTE
----------	---

Example	:SOUR:FREQ:CHAN:BAND BAND6
Initial S/W Revision	A.09.50

BAND 7

Selects BAND 7 as the band for the current step.

Key Path	Source, Frequency, Radio Setup, Radio Standard, LTE
Example	:SOUR:FREQ:CHAN:BAND BAND7
Initial S/W Revision	A.09.50

BAND 8

Selects BAND 8 as the band for the current step.

Key Path	Source, Frequency, Radio Setup, Radio Standard, LTE
Example	:SOUR:FREQ:CHAN:BAND BAND8
Initial S/W Revision	A.09.50

BAND 9

Selects BAND 9 as the band for the current step.

Key Path	Source, Frequency, Radio Setup, Radio Standard, LTE
Example	:SOUR:FREQ:CHAN:BAND BAND9
Initial S/W Revision	A.09.50

BAND 10

Selects BAND 10 as the band for the current step.

Key Path	Source, Frequency, Radio Setup, Radio Standard, LTE
Example	:SOUR:FREQ:CHAN:BAND BAND10
Initial S/W Revision	A.09.50

BAND 11

Selects BAND 11 as the band for the current step.

Key Path	Source, Frequency, Radio Setup, Radio Standard, LTE
----------	---

Example	:SOUR:FREQ:CHAN:BAND BAND11
Initial S/W Revision	A.09.50

BAND 12

Selects BAND 12 as the band for the current step.

Key Path	Source, Frequency, Radio Setup, Radio Standard, LTE
Example	:SOUR:FREQ:CHAN:BAND BAND12
Initial S/W Revision	A.09.50

BAND 13

Selects BAND 13 as the band for the current step.

Key Path	Source, Frequency, Radio Setup, Radio Standard, LTE
Example	:SOUR:FREQ:CHAN:BAND BAND13
Initial S/W Revision	A.09.50

BAND 14

Selects BAND 14 as the band for the current step.

Key Path	Source, Frequency, Radio Setup, Radio Standard, LTE
Example	:SOUR:FREQ:CHAN:BAND BAND14
Initial S/W Revision	A.09.50

BAND 17

Selects BAND 17 as the band for the current step.

Key Path	Source, Frequency, Radio Setup, Radio Standard, LTE
Example	:SOUR:FREQ:CHAN:BAND BAND17
Initial S/W Revision	A.09.50

BAND 18

Selects BAND 18 as the band for the current step.

Key Path	Source, Frequency, Radio Setup, Radio Standard, LTE
----------	---

Example	:SOUR:FREQ:CHAN:BAND BAND18
Initial S/W Revision	A.09.50

BAND 19

Selects BAND 19 as the band for the current step.

Key Path	Source, Frequency, Radio Setup, Radio Standard, LTE
Example	:SOUR:FREQ:CHAN:BAND BAND19
Initial S/W Revision	A.09.50

BAND 20

Selects BAND 20 as the band for the current step.

Key Path	Source, Frequency, Radio Setup, Radio Standard, LTE
Example	:SOUR:FREQ:CHAN:BAND BAND20
Initial S/W Revision	A.09.50

BAND 21

Selects BAND 21 as the band for the current step.

Key Path	Source, Frequency, Radio Setup, Radio Standard, LTE
Example	:SOUR:FREQ:CHAN:BAND BAND21
Initial S/W Revision	A.09.50

BAND 24

Selects BAND 24 as the band for the current step.

Key Path	Source, Frequency, Radio Setup, Radio Standard, LTE
Example	:SOUR:FREQ:CHAN:BAND BAND24
Initial S/W Revision	A.09.50

BAND 25

Selects BAND 25 as the band for the current step.

Key Path	Source, Frequency, Radio Setup, Radio Standard, LTE
----------	---

Example	:SOUR:FREQ:CHAN:BAND BAND25
Initial S/W Revision	A.09.50

BAND 26

Selects BAND 26 as the band for the current step.

Key Path	Source, Frequency, Radio Setup, Radio Standard, LTE
Example	:SOUR:FREQ:CHAN:BAND BAND26
Initial S/W Revision	A.12.53

BAND 27

Selects BAND 27 as the band for the current step.

Key Path	Source, Frequency, Radio Setup, Radio Standard, LTE
Example	:SOUR:FREQ:CHAN:BAND BAND27
Initial S/W Revision	A.14.00

BAND 28

Selects BAND 28 as the band for the current step.

Key Path	Source, Frequency, Radio Setup, Radio Standard, LTE
Example	:SOUR:FREQ:CHAN:BAND BAND28
Initial S/W Revision	A.14.00

BAND 31

Selects BAND 31 as the band for the current step.

Key Path	Source, Frequency, Radio Setup, Radio Standard, LTE
Example	:SOUR:FREQ:CHAN:BAND BAND31
Initial S/W Revision	A.14.00

LTE TDD

Sets LTE TDD as the radio standard for use and accesses the LTE TDD specific channel band sub-menus..

Key Path	Source, Frequency, Radio Setup, Radio Standard
Initial S/W Revision	A.11.50

BAND 33

Selects BAND 33 as the band for the current step.

Key Path	Source, Frequency, Radio Setup, Radio Standard, LTE TDD
Example	:SOUR:FREQ:CHAN:BAND BAND33
Initial S/W Revision	A.11.50

BAND 34

Selects BAND 34 as the band for the current step.

Key Path	Source, Frequency, Radio Setup, Radio Standard, LTE TDD
Example	:SOUR:FREQ:CHAN:BAND BAND34
Initial S/W Revision	A.11.50

BAND 35

Selects BAND 35 as the band for the current step.

Key Path	Source, Frequency, Radio Setup, Radio Standard, LTE TDD
Example	:SOUR:FREQ:CHAN:BAND BAND35
Initial S/W Revision	A.11.50

BAND 36

Selects BAND 36 as the band for the current step.

Key Path	Source, Frequency, Radio Setup, Radio Standard, LTE TDD
Example	:SOUR:FREQ:CHAN:BAND BAND36
Initial S/W Revision	A.11.50

BAND 37

Selects BAND 37 as the band for the current step.

Key Path	Source, Frequency, Radio Setup, Radio Standard, LTE TDD
Example	:SOUR:FREQ:CHAN:BAND BAND37
Initial S/W Revision	A.11.50

BAND 38

Selects BAND 38 as the band for the current step.

Key Path	Source, Frequency, Radio Setup, Radio Standard, LTE TDD
Example	:SOUR:FREQ:CHAN:BAND BAND38
Initial S/W Revision	A.11.50

BAND 39

Selects BAND 39 as the band for the current step.

Key Path	Source, Frequency, Radio Setup, Radio Standard, LTE TDD
Example	:SOUR:FREQ:CHAN:BAND BAND39
Initial S/W Revision	A.11.50

BAND 40

Selects BAND 40 as the band for the current step.

Key Path	Source, Frequency, Radio Setup, Radio Standard, LTE TDD
Example	:SOUR:FREQ:CHAN:BAND BAND40
Initial S/W Revision	A.11.50

BAND 41

Selects BAND 41 as the band for the current step.

Key Path	Source, Frequency, Radio Setup, Radio Standard, LTE TDD
Example	:SOUR:FREQ:CHAN:BAND BAND41
Initial S/W Revision	A.11.50

BAND 42

Selects BAND 42 as the band for the current step.

Key Path	Source, Frequency, Radio Setup, Radio Standard, LTE TDD
Example	:SOUR:FREQ:CHAN:BAND BAND42
Initial S/W Revision	A.11.50

BAND 43

Selects BAND 43 as the band for the current step.

Key Path	Source, Frequency, Radio Setup, Radio Standard, LTE TDD
Example	:SOUR:FREQ:CHAN:BAND BAND43
Initial S/W Revision	A.11.50

BAND 44

Selects BAND 44 as the band for the current step.

Key Path	Source, Frequency, Radio Setup, Radio Standard, LTE TDD
Example	:SOUR:FREQ:CHAN:BAND BAND44
Initial S/W Revision	A.14.00

TDSCDMA

Sets TDSCDMA as the radio standard for use and accesses the TDSCDMA specific channel band sub-menus..

Key Path	Source, Frequency, Radio Setup, Radio Standard
Initial S/W Revision	A.11.50

BAND A

Selects BAND A as the band for the current step.

Key Path	Source, Frequency, Radio Setup, Radio Standard, TDSCDMA
Example	:SOUR:FREQ:CHAN:BAND BANDA
Initial S/W Revision	A.11.50

BAND B

Selects BAND B as the band for the current step.

Key Path	Source, Frequency, Radio Setup, Radio Standard, TDSCDMA
Example	:SOUR:FREQ:CHAN:BAND BANDB
Initial S/W Revision	A.11.50

BAND C

Selects BAND C as the band for the current step.

Key Path	Source, Frequency, Radio Setup, Radio Standard, TDSCDMA
Example	:SOUR:FREQ:CHAN:BAND BANDC
Initial S/W Revision	A.11.50

BAND D

Selects BAND D as the band for the current step.

Key Path	Source, Frequency, Radio Setup, Radio Standard, TDSCDMA
Example	:SOUR:FREQ:CHAN:BAND BANDD
Initial S/W Revision	A.11.50

BAND E

Selects BAND E as the band for the current step.

Key Path	Source, Frequency, Radio Setup, Radio Standard, TDSCDMA
Example	:SOUR:FREQ:CHAN:BAND BANDE
Initial S/W Revision	A.11.50

BAND F

Selects BAND F as the band for the current step.

Key Path	Source, Frequency, Radio Setup, Radio Standard, TDSCDMA
Example	:SOUR:FREQ:CHAN:BAND BANDF
Initial S/W Revision	A.11.50

Radio Band Link

Allows you to specify the channel band type as either uplink or downlink link direction. This value is used in conjunction with the channel band and channel number to determine the absolute frequency output by the source. When set to "Uplink", the source will calculate the uplink frequency using an uplink formula together with the selected channel band and channel number. When set to "Downlink", the source will calculate the downlink frequency using a downlink formula together with the selected channel band and channel number.

Key Path	Source, Frequency, Radio Setup
Remote Command	:SOURce:RADio:BAND:LINK DOWN UP :SOURce:RADio:BAND:LINK?

Example	:SOUR:RAD:BAND:LINK UP
Preset	DOWN
Range	DOWN UP
Backwards Compatibility SCPI	:SOURce:RADio:DEVIce BTS MS
	:SOURce:RADio:DEVIce?
Backwards Compatibility Notes	BTS maps to the Downlink frequency MS maps to the Uplink frequency
Initial S/W Revision	A.05.00

Set Reference Frequency

This key allows you to set the frequency reference. Pressing this key turns the frequency reference state to ON, sets the reference frequency value to the current frequency, maintains this frequency at the RF output, and sets the displayed frequency to 0.00 Hz. All subsequent frequencies entered under Source>Frequency>Frequency are interpreted as being relative to this reference frequency.

When you use a frequency reference, the signal generator outputs a frequency that is set relative to the reference frequency by the value entered under Source>Frequency>Frequency as follows:

Output frequency = reference frequency - entered frequency

Where:

reference frequency equals the original RF frequency entered under Source>Frequency>Frequency and set as the reference frequency

entered frequency equals a new value entered under Source>Frequency>Frequency

In addition, the displayed frequency value will be the same as the value entered under Source>Frequency>Frequency.

NOTE

If Freq Reference is set to ON with a reference value set, entering a value under Source>Frequency>Frequency and pressing Set Frequency Reference will add that value to the existing Freq Reference value.

If you wish to change the reference frequency value to the new value entered under Source>Frequency>Frequency, first you must set Freq Reference to OFF and then press Set Frequency Reference.

Key Path	Source, Frequency
Remote Command	:SOURce:FREQuency:REFerence:SET
Example	:SOUR:FREQ:REF:SET
Dependencies	This setting is unavailable, and is grayed out when the List Sequencer is turned ON.
Initial S/W Revision	A.05.00

Freq Reference

This key allows you to toggle the state of the frequency reference. When the frequency reference state is ON, an annunciator is displayed on the main source view to indicate this state to the user.

When you use a frequency reference, the signal generator outputs a frequency that is set relative to the reference frequency by the value entered under Source>Frequency>Frequency as follows:

Output frequency = reference frequency + entered frequency

Where:

reference frequency equals the original RF frequency entered under Source>Frequency>Frequency and set as the reference frequency

entered frequency equals a new value entered under Source>Frequency>Frequency

For more information on Reference Frequency refer to ["Set Reference Frequency" on page 2127](#)

Key Path	Source, Frequency
Remote Command	:SOURce:FREQuency:REFerence <freq> :SOURce:FREQuency:REFerence? :SOURce:FREQuency:REFerence:STATe OFF ON 0 1 :SOURce:FREQuency:REFerence:STATe?
Example	:SOUR:FREQ:REF 0.00 Hz :SOUR:FREQ:REF:STATe ON
Dependencies	This setting is unavailable, and is grayed out when the List Sequencer is turned ON.
Couplings	The frequency reference state is coupled to the frequency reference set immediate action. When the reference set immediate action key is pressed, or the SCPI command issued, it turns the frequency reference state ON.
Preset	0.00 Hz OFF
Min	0.00 Hz
Max	Hardware Dependant: Option 503 = 3.6 GHz Option 504 = 3.8 GHz Option 506 = 6.00 GHz
Initial S/W Revision	A.05.00

Freq Offset

Allows you to specify the frequency offset value. When the frequency offset state is ON, an annunciator is displayed on the main source view to indicate this state to the user.

When the frequency offset is set to zero (0) and you set a new offset value, the displayed frequency value will change as follows and the RF output frequency will not change:

Displayed value = output frequency + offset value

Where:

output frequency equals the original frequency entered under Source>Frequency>Frequency

offset value equals the value entered under Source>Frequency>Freq Offset

When the frequency offset is set to a value other than zero (0) and you enter a new frequency value under Source>Frequency>Frequency, the displayed frequency will be the same as the value entered and the RF output frequency will be equal to the value entered minus the offset value as follows:

Output frequency = entered frequency – offset frequency

Displayed frequency = output frequency + offset frequency

Displayed frequency = entered frequency

Where:

entered frequency equals the frequency entered under Source>Frequency>Frequency

offset frequency equals the value previously entered and set under Source>Frequency>Freq Offset

Key Path	Source, Frequency
Remote Command	:SOURce:FREQuency:OFFSet <freq> :SOURce:FREQuency:OFFSet?
Example	:SOUR:FREQ:OFFS 0 Hz
Dependencies	This setting is unavailable, and is grayed out when the List Sequencer is turned ON.
Preset	0 Hz
Min	-100.00 GHz
Max	100.00 GHz
Initial S/W Revision	A.05.00

Modulation Setup

Allows access to the menus for setting up the available modulation types: "ARB" on page 2143, "AM" on page 2164, "FM" on page 2165, and "PM" on page 2167.

Key Path	Source
Initial S/W Revision	A.05.00

ARB

Allows you access to the ARB sub-menus.

Key Path	Source, Modulation Setup
Initial S/W Revision	A.05.00

ARB

Allows you to toggle the state of the ARB function. When the ARB is On, a “MOD” annunciator is displayed in the system settings panel. When the ARB is turned Off, the MOD annunciator is cleared

Key Path	Source, Modulation Setup, ARB
Remote Command	:SOURce:RADio:ARB[:STATe] ON OFF 1 0 :SOURce:RADio:ARB[:STATe]?
Example	:SOUR:RAD:ARB OFF :SOUR:RAD:ARB?
Notes	If the ARB is ON, a user then loads or deletes another file to ARB memory, the playing waveform segment may not keep phase continuity during the ARB memory operation. The waveform will be replayed after the ARB operation is finished.
Dependencies	This setting is for independent mode and has no effect on 3.3.8 list sequencer mode. Setting "Sequencer" on page 2168 Sequencer to On will put source enter list sequencer mode, and even if ARB state is On, the ARB file will not be played. Setting "Sequencer" on page 2168 Sequencer to Off will make source leave list sequencer mode, and this setting will take effect immediately. The ARB can only be turned on when there is a waveform file selected for playback. On the GUI if no waveform is selected, this key is grayed out. If you send the SCPI command to turn the ARB on with no waveform selected for playback, the ARB state remains OFF and an error is generated. "- When you try to recall a certain set of states in which the selected waveform is not in ARB memory and the ARB state is On, errors are reported
Preset	Off
Range	On Off
Initial S/W Revision	A.05.00

Select Waveform

Allows you to access to the waveform selection sub-menus.

Pressing this key changes the central view area to show the Waveform File Selection view.

Key Path	Source, Modulation Setup, ARB
Initial S/W Revision	A.05.00

Select Waveform

Allows you to select a waveform sequence or segment for the dual ARB to play.

NOTE: Selecting a waveform file does not result in automatic adjustments to burst timing (to compensate for the presence or absence of a Multiport Adapter); that adjustment occurs only when a waveform is loaded to ARB memory. See "Load Segment to ARB Memory" for more information about this adjustment.

Key Path	Source, Modulation Setup, ARB, Select Waveform
Remote Command	:SOURce:RADio:ARB:WAVeform <string> :SOURce:RADio:ARB:WAVeform?
Example	:SOUR:RAD:ARB:WAV "test_waveform.bin"
Notes	<p>If intended waveform is not in the memory yet, then issuing this command by SCPI will invoke ARB loading operation first, which involves a delay of unpredictable length. So this command should be followed by the query *OPC?, which holds off subsequent commands until the loading operating is complete.</p> <p><string> - specifies the name of the waveform segment or waveform sequence to be played by the ARB.</p> <p>When in Sequence Analyzer mode, and Include Source is Yes, if the you attempt to play a waveform sequence but not all the required waveform segments are in the ARB playback memory, the application will reject the loading operation with an error is generated .</p> <p>When Include Source is No, if you attempt to play a waveform sequence but not all the required waveform segments are contained in the ARB playback memory, the application will attempt to load the required segments from either the default directory of the current directory. If the ARB memory does not have enough space for all the waveform segments to be loaded, an error is generated and none of the waveform segments is loaded.</p> <p>If the ARB is ON, and you attampt to play a waveform sequence but not all the waveform segments within the sequence could be found to be loaded into ARB memory, an error is generated. The selected waveform keeps the previous value and ARB state remains On.</p> <p>If you specify a waveform segment over SCPI but the waveform segment is not present within ARB playback memory and cannot be found for auto loading within the current directory or the default directory, an error is generatedand the file selection remains unchanged.</p> <p>If you select a waveform for playback and the waveform requires a license that is not installed on the instrument, an error is generated.error is generated.</p> <p>If the ARB is ON and you load a file to ARB memory or delete a file from ARB memory, the playing waveform segment may not keep phase continuity during the ARB memory operation. The waveform will be replayed after the ARB operation is finished.</p>
Initial S/W Revision	A.05.00

Segments on Hard Disk

Allows you access to the sub-menus for loading waveform segments from the hard disk into ARB memory. The default directory is: D: varb.

Pressing this key changes the current view to the Waveform Management View.

Key Path	Source, Modulation Setup, ARB, Select Waveform
Initial S/W Revision	A.05.00

Load Segment To ARB Memory

Allows you to load the selected file into ARB memory. On the front panel you select the file for loading to the ARB memory by highlighting the desired file in the list. Using the SCPI command, you specify the file

name on the HDD.

“NVWFM” (none-volatile storage) MSUS (Mass Storage Unit Specifier) is supported in the memory subsystem because the ARB memory cannot be accessed directly. Therefore, files must be downloaded to the instrument hard disk and then loaded into the ARB memory. “NVWFM” MSUS will be mapped to the default directory D: VARB. The SCPI command supports using either “NVWFM” MSUS or specifying a full path. For more information, see Memory Subsystem (Remote Command Only).

If a file of the same name already exists within ARB memory, it is overwritten. If you wish to load two segments of the same name, you must rename one of the segments before loading it into ARB memory. To rename a segment, you can either use Windows File Explorer, or the :MMEMORY:COPY command.

NOTE: When a waveform file is loaded to ARB memory, burst timing adjustments are made automatically, based on whether or not a Multiport Adapter is connected to the test set and powered on. If the connection/power status of the Multiport Adapter is changed after a waveform file has been loaded, it needs to be loaded again.

Key Path	Source, Modulation Setup, ARB, Select Waveform, Segments on Hard Disk
Remote Command	:SOURCE:RADio:ARB:LOAD <string>
Example	:SOUR:RAD:ARB:LOAD "D: VARB\testwaveform.bin" or :SOUR:RAD:ARB:LOAD "NVWFM:testwaveform.bin"
Notes	<p>Because loading the file involves a delay of unpredictable length, this command should be followed by the query *OPC?, which holds off subsequent commands until the loading operating is complete.</p> <p><string> - specifies the path name of the file to load from the HDD into ARB memory. It could be a <full path + filename>, or <"NVWFM" MSUS + colon + filename>.</p> <p>When in Sequence Analyzer mode, and Include Source is Yes, an attempt to load a file to ARB memory will be rejected with an error.</p> <p>When Include Source is No and if there is insufficient free ARB memory to load the selected waveform, an error is generated. .</p> <p>If you specify a file over SCPI, but the file is not at the specified location, an error is generated.</p> <p>If you try to load a waveform file but the file contains less than 500 IQ samples, an error is generated.</p> <p>If you try to load a Signal Studio waveform "*.wfm" which contains invalid waveform header, an error is generated.</p> <p>If the ARB is ON when you load a file to ARB memory or delete a file from ARB memory, the playing waveform segment may not keep phase continuity during the ARB memory operation. The waveform will be replayed after the ARB operation is finished.</p> <p>ARB can be loaded into ARB memory even required licenses do not present on the instrument. In this case, a GUI only warning message -800, "Operation complete; Loaded <filename> successfully, but no license <required licenses> installed". User can install required licenses according to <required licenses> string to license it, or multi-pack license it.</p>
Initial S/W Revision	A.05.00

Load All To ARB Memory

Allows you to load all the segment files within the currently selected directory into ARB memory. If a file of the same name already exists within ARB memory, it is overwritten. If you wish to load two segments of the

same name, you must rename one of the segments before loading it into ARB memory. To rename a segment, you can either use Windows File Explorer, or the :MEMory:COpy command.

NOTE: When a waveform file is loaded to ARB memory, burst timing adjustments are made automatically, based on whether or not a Multiport Adapter is connected to the test set and powered on. If the connection/power status of the Multiport Adapter is changed after a waveform file has been loaded, it needs to be loaded again.

Key Path	Source, Modulation Setup, ARB, Select Waveform, Segments on Hard Disk
Remote Command	:SOURce:RADio:ARB:LOAD:ALL <string>
Example	:SOUR:RAD:ARB:LOAD:ALL "D: varb"
Notes	<p><string> - specifies the directory on the HDD to load the files into ARB memory from.</p> <p>When in Sequence Analyzer mode, and Include Source is Yes, an attempt to load all files from a directory to ARB memory is rejected with an error.</p> <p>When Include Source is No and there is insufficient free ARB memory to load all the waveforms, when the ARB memory is full, the copy ceases, and an error is generated.</p> <p>If you specify a directory over SCPI, but the directory does not exist, an error is generated.</p> <p>If the ARB is ON, a user then loads or deletes file to ARB memory, the playing waveform segment may not keep phase continuity during the ARB memory operation. The waveform will be replayed after the ARB operation is finished.</p>
Initial S/W Revision	A.05.00

Change Directory...

Allows you to change the currently selected directory on the hard disk. Pressing this key opens a standard windows change directory dialog allowing you to select the new directory of interest.

The current directory is used for manually loading waveform segments into ARB memory for playback, and as a search location for waveform segments that are required to be loaded into ARB memory for playback of a waveform sequence or a list sequence.

Key Path	Source, Modulation Setup, ARB, Select Waveform, Segments on Hard Disk
Notes	No remote command, SCPI front panel only.
Initial S/W Revision	A.05.00

Default Directory...

Allows you to change the default directory. It is used as a search location for waveform segments that are required to be loaded into ARB memory for playback of a waveform sequence, and as a search location for selecting waveforms using SCPI.

Key Path	Source, Modulation Setup, ARB, Select Waveform, Segments on Hard Disk
Remote Command	:SOURce:RADio:ARB:DEFault:DIRectory <string> :SOURce:RADio:ARB: DEFault:DIRectory?
Example	:SOUR:RAD:ARB:DEF:DIR "D:\ArbFiles"

	:SOUR:RAD:ARB:DEF:DIR?
State Saved	Persistent, survives a power cycle and a preset but not saved in the instrument state
Initial S/W Revision	A.05.00

Segments in ARB Memory

Allows you access to the sub-menus for managing the files within ARB memory.

Key Path	Source, Modulation Setup, ARB, Select Waveform
Initial S/W Revision	A.05.00

Delete Segment From ARB Mem

Allows you to remove a segment from ARB playback memory.

Key Path	Source, Modulation Setup, ARB, Select Waveform, Segments in ARB Memory
Remote Command	:SOURce:RADio:ARB:DELeTe <string>
Example	:SOUR:RAD:ARB:DEL "testwaveform.bin"
Notes	<p><string> - specifies the waveform to be deleted from the ARB playback memory.</p> <p>When in Sequence Analyzer mode and Include Source is Yes, an attempt to delete a file from ARB memory is rejected with an error.</p> <p>When Include Source is No and you specify a file that does not exist within ARB memory, an error is generated.</p> <p>It is possible to delete files from within the ARB memory when the ARB is ON. However, if you attempt to delete the file that is currently playing an error is generated.</p> <p>It is possible to delete a file from within the ARB memory when the sequencer state is ON and the file is not being used by the List Sequencer. If you attempt to delete a file which is being used by the list sequencer, an error is generated.</p> <p>When sequencer state is On, even if ARB state is On, the selected waveform will not be played. In this case, if the selected waveform is not used in List Sequence, it can be deleted and the ARB state is turned Off.</p> <p>If the ARB is ON and you load a file to ARB memory or delete a file from ARB memory, the playing waveform segment may not keep phase continuity during the ARB memory operation. The waveform will be replayed after the ARB operation is finished.</p>
Initial S/W Revision	A.05.00

Delete All From ARB Memory

Allows you to remove all segments from ARB playback memory.

Key Path	Source, Modulation Setup, ARB, Select Waveform, Segments in ARB Memory
----------	--

Remote Command	:SOURce:RADio:ARB:DELeTe:ALL
Example	:SOUR:RAD:ARB:DELeTe:ALL
Notes	<p>When in Sequence Analyzer mode and Include Source is Yes, an attempt to delete all files from ARB memory is rejected with an error.</p> <p>When Include Source is No and you attempt to delete all files from ARB memory when the ARB is currently playing a file, all files except the one playing are deleted and an error is generated.</p> <p>If you attempt to delete all files from ARB memory when there are waveform files used in "List Sequencer" on page 2168 and "Sequencer" on page 2168 state is ON, all files except the files currently being used in list sequencer are deleted, and an error is generated.</p> <p>If the ARB is ON and you load a file to ARB memory or delete a file from ARB memory, the playing waveform segment may not keep phase continuity during the ARB memory operation. The waveform will be replayed after the ARB operation is finished.</p>
Initial S/W Revision	A.05.00

ARB Setup

Allows access to the ARB setup sub-menus.

Key Path	Source, Modulation Setup, ARB
Initial S/W Revision	A.05.00

Sample Rate

Allows you to set the ARB waveform playback sample rate.

Key Path	Source, Modulation Setup, ARB, ARB Setup
Remote Command	:SOURce:RADio:ARB:SCLock:RATE <freq> :SOURce:RADio:ARB:SCLock:RATE?
Example	:SOUR:RAD:ARB:SCL:RATE 48.00 MHz
Notes	If there is a sample rate specified in the header of the waveform file, changing that sample rate is not recommended, as it may cause problems with burst timing.
Dependencies	When a new waveform is selected for playback the settings contained within the associated waveform header file are applied to the ARB. The sample rate is one of the values stored within the header file. If the newly selected waveform file has an associated header file, the sample rate is updated with the value from the header file. The sample rate will remain unchanged if the newly selected waveform does not have an associated header file.
Preset	125.00 MHz
Min	1.00 kHz
Max	125.00 MHz
Initial S/W Revision	A.05.00

Run-Time Scaling

Allows you to adjust the run-time scaling value. The run-time scaling value is applied in real-time while the waveform is playing.

Key Path	Source, Modulation Setup, ARB, ARB Setup
Remote Command	:SOURce:RADio:ARB:RSCaling <real> :SOURce:RADio:ARB:RSCaling?
Example	:SOUR:RAD:ARB:RSC 100.00
Notes	This setting cannot be set in E6640A/M9420A. Grey out on menu and the value is fixed at 70.00%.
Dependencies	When a new waveform is selected for playback the settings contained within the associated waveform header file are applied to the ARB. The run-time scaling is one of the values stored within the header file. If the newly selected waveform file has an associated header file, the run-time scaling is updated with the value from the header file. The run-time scaling will remain unchanged if the newly selected waveform does not have an associated header file.
Preset	70.00 %
Min	1.00 %
Max	100.00 %
Initial S/W Revision	A.05.00

Baseband Freq Offset

Allows you to adjust the value by which the baseband frequency is offset relative to the carrier.

Key Path	Source, Modulation Setup, ARB, ARB Setup
Remote Command	:SOURce:RADio:ARB:BASEband:FREQuency:OFFSet <freq> :SOURce:RADio:ARB:BASEband:FREQuency:OFFSet?
Example	:SOUR:RAD:ARB:BAS:FREQ:OFFS 0.00 Hz
Dependencies	When a new waveform is selected for playback the settings contained within the associated waveform header file are applied to the ARB. The baseband frequency offset is one of the values stored within the header file. If the newly selected waveform file has an associated header file, the baseband frequency offset is updated with the value from the header file. The baseband frequency offset will remain unchanged if the newly selected waveform does not have an associated header file.
Preset	0.00 Hz
Min	-50.00 MHz
Max	50.00 MHz
Initial S/W Revision	A.05.00

Edit RMS

Allows you to edit or calculate current RMS of selected waveform.

Key Path	Source, Modulation Setup, ARB, ARB Setup
Initial S/W Revision	A.14.50

Current RMS

Allows you to directly specify current RMS value used to playback currently selected waveform. Please note incorrect RMS value may cause inaccurate power output in E6640A/M9420A that is sensitive to RMS value.

This setting is also updated by RMS in waveform header or updated when invoking RMS calculation operation.

This setting can be saved to the header of currently selected waveform by invoking ["Save Setup To Header" on page 2164](#) "Save Setup To Header".

Key Path	Source, Modulation Setup, ARB, ARB Setup, Edit RMS
Remote Command	:SOURce:RADio:ARB:RMS <float> :SOURce:RADio:ARB:RMS?
Example	:SOUR:RAD:ARB:HEAD:RMS 0.7 :SOUR:RAD:ARB:HEAD:RMS?
Notes	Valid range is 0 to 1.414, values outside the range will be clipped to the closest boundary. Note this value does not affect "List Sequencer" on page 2168 Source List Sequencer that always uses RMS value resides in each ARB header. If want this value to take effect in list sequencer, use "Save Setup To Header" on page 2164 "Save Setup to Header" to save current RMS value to header first, then play the ARB in source list sequencer.
Dependencies	When a new waveform is selected for playback, this setting is updated by the RMS value defined in associated waveform header file. If selected waveform has no associated header file or header file does not specify RMS value, then instrument will try to calculate out one automatically. Calculating RMS can also update this setting.
Preset	0
Range	0 ~ 1.414
Initial S/W Revision	A.14.50

RMS Calculation Mode

Allows you to specify the mode to calculate the current RMS.

Key Path	Source, Modulation Setup, ARB, ARB Setup, Edit RMS
Remote Command	:SOURce:RADio:ARB:RMS:CALCulation:MODE AUTO M1 M2 M3 M4 :SOURce:RADio:ARB:RMS:CALCulation:MODE?
Example	:SOUR:RAD:ARB:RMS:CALC:MODE AUTO
Notes	If no waveform is selected, or selected waveform is waveform sequence, the key will grey out.

Preset	AUTO
Range	AUTO M1 M2 M3 M4
Initial S/W Revision	A.14.50

Auto

RMS will be calculated based on the whole sample range of current selected waveform.

Key Path	Source, Modulation Setup, ARB, ARB Setup, Edit RMS, Calculate RMS, RMS Calculation Mode
Example	:SOUR:RAD:ARB:RMS:CALC:MODE AUTO
Initial S/W Revision	A.14.50

Marker 1

Selects marker 1 to designate sample range used for RMS calculation.

Key Path	Source, Modulation Setup, ARB, ARB Setup, Edit RMS, Calculate RMS, RMS Calculation Mode , Marker
Example	:SOUR:RAD:ARB:RMS:CALC:MODE M1
Initial S/W Revision	A.14.50

Marker 2

Selects marker 2 to designate sample range used for RMS calculation.

Key Path	Source, Modulation Setup, ARB, ARB Setup, Edit RMS, Calculate RMS, RMS Calculation Mode , Marker
Example	:SOUR:RAD:ARB:RMS:CALC:MODE M2
Initial S/W Revision	A.14.50

Marker 3

Selects marker 3 to designate sample range used for RMS calculation.

Key Path	Source, Modulation Setup, ARB, ARB Setup, Edit RMS, Calculate RMS, RMS Calculation Mode , Marker
Example	:SOUR:RAD:ARB:RMS:CALC:MODE M3
Initial S/W Revision	A.14.50

Marker 4

Selects marker 4 to designate sample range used for RMS calculation.

Key Path	Source, Modulation Setup, ARB, ARB Setup, Edit RMS, Calculate RMS, RMS Calculation Mode , Marker
Example	:SOUR:RAD:ARB:RMS:CALC:MODE M4
Initial S/W Revision	A.14.50

Calculate RMS

Allows you to calculate current RMS based on mode selected. This will update "[Current RMS](#)" on page 2137 Current RMS setting.

Key Path	Source, Modulation Setup, ARB, ARB Setup, Edit RMS, Calculate RMS
Remote Command	:SOURce:RADio:ARB:RMS:CALCulate
Example	:SOUR:RAD:ARB:RMS:CALC
Notes	<p>If no waveform is selected, invoking this operation will get error “-221 Setting conflict; No waveform is selected for RMS operation”.</p> <p>If no waveform is selected, or selected waveform is waveform sequence, the key will grey out.</p> <p>If selected waveform does not contain marker data, but "RMS Calculation Mode" on page 2137 “RMS Calculation Mode” is set to marker, under this circumstance, invoking calculation operation will get error “-221 Setting conflict; There is no marker for currently selected waveform, auto RMS calculation mode is used instead”, and "RMS Calculation Mode" on page 2137 “RMS Calculation Mode” will be coupled to “Auto” mode automatically.</p> <p>RMS calculation does not suit for waveform sequence. If selected waveform is waveform sequence file, invoking this operation will get error “-221 Setting conflict; RMS calculation does not apply to waveform sequence”. But users can still edit current RMS as play parameter, and can save current RMS to waveform sequence header for later use.</p>
Initial S/W Revision	A.14.50

Use Header RMS

Allows you to quickly set RMS in ARB header to "[Current RMS](#)" on page 2137 Current RMS setting.

Key Path	Source, Modulation Setup, ARB, ARB Setup, Edit RMS,
Notes	<p>No remote command, front panel only.</p> <p>If no waveform is selected, the key will grey out.</p> <p>If no waveform is selected, invoking this operation will get error “-221 Setting conflict; No waveform is selected for RMS operation”.</p>
Initial S/W Revision	A.14.50

Trigger Type

Allows access to the trigger type sub-menus. The setting for trigger type determines the behavior of the waveform when it plays.

Key Path	Source, Modulation Setup, ARB
Remote Command	:SOURce:RADio:ARB:TRIGger:TYPE CONTInuous SINGLE SADVance :SOURce:RADio:ARB:TRIGger:TYPE?
Example	:SOUR:RAD:ARB:TRIG:TYPE CONT :SOUR:RAD:ARB:TRIG:TYPE?
Notes	Gated trigger type will be implemented at a later release
Preset	CONTInuous
Range	Continuous Single Seg Adv
Initial S/W Revision	A.05.00

Continuous

Sets the active trigger type to Continuous. If Continuous is already selected as the active trigger type, pressing this key allows access to the continuous trigger type setup menu. In Continuous trigger mode, the waveform repeats continuously.

Key Path	Source, Modulation Setup, ARB, Trigger Type
Remote Command	:SOURce:RADio:ARB:TRIGger:TYPE:CONTInuous[:TYPE] FREE TRIGger RESet :SOURce:RADio:ARB:TRIGger:TYPE:CONTInuous[:TYPE]?
Example	:SOUR:RAD:ARB:TRIG:TYPE:CONT FREE
Preset	FREE
Range	Free Run Trigger + Run Reset + Run
Initial S/W Revision	A.05.00

Free Run

Selects Free Run as the trigger response for the continuous trigger type. Free Run sets the waveform generator to play a waveform sequence or segment continuously, without waiting for a trigger. In this mode, the waveform generator does not respond to triggers.

Key Path	Source, Modulation Setup, ARB, Trigger Type, Continuous
Example	:SOUR:RAD:ARB:TRIG:TYPE:CONT FREE
Initial S/W Revision	A.05.00

Trigger + Run

Sets Trigger and Run as the trigger response for the continuous trigger type. Trigger and Run sets the waveform generator to play a waveform sequence or segment continuously when the first trigger is received, and to ignore any subsequent triggers.

Key Path	Source, Modulation Setup, ARB, Trigger Type, Continuous
Example	:SOUR:RAD:ARB:TRIG:TYPE:CONT TRIG
Initial S/W Revision	A.05.00

Reset + Run

Sets Reset and Run as the trigger response for the continuous trigger type. Reset and Run sets the waveform generator to play a waveform sequence or segment continuously when the first trigger is received. Subsequent triggers reset the waveform sequence or segment to the start, and then play it continuously.

Key Path	Source, Modulation Setup, ARB, Trigger Type, Continuous
Example	:SOUR:RAD:ARB:TRIG:TYPE:CONT RES
Initial S/W Revision	A.05.00

Single

Sets the active trigger type to Single. If Single is already selected as the active trigger type, pressing this key allows access to the single trigger type setup menu. In Single trigger mode, the waveform plays once.

Key Path	Source, Modulation Setup, ARB, Trigger Type
Remote Command	:SOURce:RADio:ARB:RETRigger ON OFF IMMEDIATE :SOURce:RADio:ARB:RETRigger?
Example	:SOUR:RAD:ARB:RETR OFF
Notes	ON: Buffered Trigger OFF: No Retrigger Immediate: Restart on Trigger This is defined as an enumerated SCPI command, with ON OFF being considered as enumerated types rather than Boolean. This means the query will return OFF instead of 0, and ON instead of 1.
Preset	ON
Range	No Retrigger Buffered Trigger Restart on Trigger
Initial S/W Revision	A.05.00

No Retrigger

Selects No Retrigger as the trigger response for single trigger type. No Retrigger sets the waveform generator to play a waveform sequence or segment once when a trigger is received. Any triggers then

received during playback are ignored.

Key Path	Source, Modulation Setup, ARB, Trigger Type, Single
Example	:SOUR:RAD:ARB:RETR OFF
Initial S/W Revision	A.05.00

Buffered Trigger

Selects Buffered Trigger as the trigger response for single trigger type. Buffered Trigger sets the waveform generator to play a waveform sequence or segment once when a trigger is received. If a trigger is received during playback, the waveform generator plays the sequence or segment to the end, then plays the sequence or segment once more.

Key Path	Source, Modulation Setup, ARB, Trigger Type, Single
Example	:SOUR:RAD:ARB:RETR ON
Initial S/W Revision	A.05.00

Restart on Trigger

Selects Restart on Trigger as the trigger response for single trigger type. Restart on Trigger sets the waveform generator to play a waveform sequence or segment once when a trigger is received. If a trigger is received during playback, the waveform generator resets and plays the sequence or segment from the start.

Key Path	Source, Modulation Setup, ARB, Trigger Type, Single
Example	:SOUR:RAD:ARB:RETR IMM
Initial S/W Revision	A.05.00

Segment Advance

Sets the active trigger type to Segment Advance. If Segment Advance is already selected as the active trigger type, pressing this key allows access to the segment advance trigger type setup menu.

Segment Advance triggering allows you to control the playback of waveform segments within a waveform sequence. When a trigger is received the ARB advances to the next waveform segment within the waveform sequence. This type of triggering ignores the repetition count for the waveform segment within the waveform sequence. For example, if a waveform segment has a repetition count of 10 and you select single segment advance triggering mode, the waveform segment will only play once.

Segment Advance triggering can also be used for waveform segments only. In this situation the same waveform segment is played again when a trigger is received.

Key Path	Source, Modulation Setup, ARB, Trigger Type
Remote Command	:SOURce:RADio:ARB:TRIGger:TYPE:SADVance[:TYPE] SINGLE CONTInuous

	:SOURce:RADio:ARB:TRIGger:TYPE:SADVance[:TYPE]?
Example	:SOUR:RAD:ARB:TRIG:TYPE:SADV SING
Preset	CONTInuous
Range	Single Continuous
Initial S/W Revision	A.05.00

Single

Selects Single as the trigger response for Segment Advance trigger type. With single selected, once a trigger is received a segment is played once. If a trigger is received during playback of a segment, the segment plays to completion and the next segment is played once.

Key Path	Source, Modulation Setup, ARB, Trigger Type, Segment Advance
Example	:SOUR:RAD:ARB:TRIG:TYPE:SADV SING
Initial S/W Revision	A.05.00

Continuous

Selects Continuous as the trigger response for Segment Advance trigger type. With continuous selected, once a trigger is received a segment is played continuously. When subsequent triggers are received, the currently playing segment plays to completion and then the next segment is played continuously.

Key Path	Source, Modulation Setup, ARB, Trigger Type, Segment Advance
Example	:SOUR:RAD:ARB:TRIG:TYPE:SADV CONT
Initial S/W Revision	A.05.00

ARB

Allows you access to the ARB sub-menus.

Key Path	Source, Modulation Setup
Initial S/W Revision	A.05.00

Trigger Source

The trigger source setting determines how the source receives the trigger that starts the waveform playing. Therefore, this key is grayed out if the trigger type is free run, since free run triggers immediately with no trigger source required.

Key Path	Source, Modulation Setup, ARB
Remote Command	:SOURce:RADio:ARB:TRIGger[:SOURce] KEY BUS EXTernal2

	:SOURce:RADio:ARB:TRIGger[:SOURce]?
Example	:SOUR:RAD:ARB:TRIGger KEY
Dependencies	This key is grayed out if the current trigger type is Continuous, Free Run.
Preset	EXTernal2
Range	Trigger Key Bus External 2
Initial S/W Revision	A.05.00

Trigger Key

Sets the current trigger source to the front panel Trigger key. When Trigger Key is selected, the waveform is triggered when you press the front panel Trigger key.

Key Path	Source, Modulation Setup, ARB, Trigger Source
Example	:SOUR:RAD:ARB:TRIGger KEY
Initial S/W Revision	A.05.00

Bus

Sets the current trigger source to Bus. Selecting Bus trigger source enables triggering over GPIB, LAN, or USB using the :SOURce:RADio:ARB:TRIGger:INITiate command.

Key Path	Source, Modulation Setup, ARB, Trigger Source
Example	:SOUR:RAD:ARB:TRIGger BUS
Initial S/W Revision	A.05.00

External 2

Sets the current trigger source to External 2. Selecting External 2 enables triggering a waveform by an externally applied signal.

Key Path	Source, Modulation Setup, ARB, Trigger Source
Example	:SOUR:RAD:ARB:TRIGger EXT2
Notes	Note: When on E6640A, trigger 2 is a bi-directional trigger port. So when trigger 2 has been configured as OUTPUT type, choosing External 2 as the input trigger for the current step will generate error.
Initial S/W Revision	A.05.00

External Trigger Delay

This key allows you to toggle the state and value of external trigger delay. The value you enter sets a delay time between when an external trigger is received and when it is applied to the waveform. This is key is

active only if you select external trigger as trigger source.

Key Path	Source, Modulation Setup, ARB, Trigger Source
Remote Command	:SOURce:RADio:ARB:TRIGger[:SOURce]:EXTernal:DELay <time> :SOURce:RADio:ARB:TRIGger[:SOURce]:EXTernal:DELay? SOURce:RADio:ARB:TRIGger[:SOURce]:EXTernal:DELay:STATe OFF ON 0 1 :SOURce:RADio:ARB:TRIGger[:SOURce]:EXTernal:DELay:STATe?
Example	:SOUR:RAD:ARB:TRIG:EXT:DEL 100ns :SOUR:RAD:ARB:TRIG:EXT:DEL? :SOUR:RAD:ARB:TRIG:EXT:DEL:STAT ON :SOUR:RAD:ARB:TRIG:EXT:DEL:STAT?
Notes	External trigger delay time set by users will be rounded to the nearest integer multiple of the resolution.
Dependencies	This setting is unavailable and is grayed out when the Trigger Source is not set to external trigger.
Preset	1 ms OFF
Min	0 s
Max	8.589934588 s (Note: This value comes from $4\text{ns} * (2^{31} - 1) = 8589934588\text{ ns}$)
Initial S/W Revision	A.14.50

Trigger Initiate

Used to initiate an immediate trigger event if the trigger source is set to Trigger Key.

Key Path	Source, Modulation Setup, ARB
Notes	No remote command, SCPI front panel only.
Initial S/W Revision	A.05.00

Waveform Sequences

Allows access to the waveform sequence sub-menus. Pressing this key changes the central view area to display the Waveform Sequence List view.

Key Path	Source, Modulation Setup, ARB
Notes	No remote command, SCPI front panel only.
Initial S/W Revision	A.05.00

Build New Sequence

Allows access to the sub-menus for creating a new waveform sequence. Pressing this key changes the central view area to display the Waveform Sequence Creation and Editing view.

Key Path	Source, Modulation Setup, ARB, Waveform Sequences
Notes	No remote command, SCPI front panel only.
Initial S/W Revision	A.05.00

Current Segment

Specifies the selected sequence segment that will be affected by the menu functions.

Key Path	Source, Modulation Setup , ARB, Waveform Sequences, Build New Sequence
Notes	No remote command, SCPI front panel only. This key is grayed out and unavailable if the sequence is currently empty.
Initial S/W Revision	A.05.00

Insert New Waveform

Allows you access to the sub-menu for inserting a new waveform segment or sequence. Pressing this key also changes the central display to show the Waveform File Selection View.

Key Path	Source, Modulation Setup, ARB, Waveform Sequences, Build New Sequence
Notes	No remote command, SCPI front panel only. Waveform segment name string length upper limit is 128 chars. Please do NOT insert waveform which name string exceeds 128 chars.
Initial S/W Revision	A.05.00

Insert Waveform

Inserts the currently highlighted waveform to the end of the waveform sequence. Pressing this key also returns you to the menus for creating or editing a sequence, and returns the central view to the sequence creation view.

Key Path	Source, Modulation Setup, ARB, Waveform Sequences, Build New Sequence, Insert New Waveform
Notes	No remote command, SCPI front panel only. Waveform segment name string length upper limit is 128 chars. Please do NOT insert waveform which name string exceeds 128 chars.
Initial S/W Revision	A.05.00

Segments on Hard Disk

Allows you access to the sub-menus for loading waveform segments from the hard disk into ARB memory. The default directory is: D: varb.

Pressing this key changes the current view to the Waveform Management View.

Key Path	Source, Modulation Setup, ARB, Select Waveform
Initial S/W Revision	A.05.00

Load Segment To ARB Memory

Allows you to load the selected file into ARB memory. On the front panel you select the file for loading to the ARB memory by highlighting the desired file in the list. Using the SCPI command, you specify the file name on the HDD.

“NVWFM” (none-volatile storage) MSUS (Mass Storage Unit Specifier) is supported in the memory subsystem because the ARB memory cannot be accessed directly. Therefore, files must be downloaded to the instrument hard disk and then loaded into the ARB memory. “NVWFM” MSUS will be mapped to the default directory D: VARB. The SCPI command supports using either “NVWFM” MSUS or specifying a full path. For more information, see Memory Subsystem (Remote Command Only).

If a file of the same name already exists within ARB memory, it is overwritten. If you wish to load two segments of the same name, you must rename one of the segments before loading it into ARB memory. To rename a segment, you can either use Windows File Explorer, or the :MMEMory:COPI command.

NOTE: When a waveform file is loaded to ARB memory, burst timing adjustments are made automatically, based on whether or not a Multiport Adapter is connected to the test set and powered on. If the connection/power status of the Multiport Adapter is changed after a waveform file has been loaded, it needs to be loaded again.

Key Path	Source, Modulation Setup, ARB, Select Waveform, Segments on Hard Disk
Remote Command	:SOURce:RADio:ARB:LOAD <string>
Example	:SOUR:RAD:ARB:LOAD "D: VARB\testwaveform.bin" or :SOUR:RAD:ARB:LOAD "NVWFM:testwaveform.bin"
Notes	<p>Because loading the file involves a delay of unpredictable length, this command should be followed by the query *OPC?, which holds off subsequent commands until the loading operating is complete.</p> <p><string> – specifies the path name of the file to load from the HDD into ARB memory. It could be a <full path + filename>, or <“NVWFM” MSUS + colon + filename>.</p> <p>When in Sequence Analyzer mode, and Include Source is Yes, an attempt to load a file to ARB memory will be rejected with an error.</p> <p>When Include Source is No and if there is insufficient free ARB memory to load the selected waveform, an error is generated. .</p> <p>If you specify a file over SCPI, but the file is not at the specified location, an error is generated.</p> <p>If you try to load a waveform file but the file contains less than 500 IQ samples, an error is generated.</p> <p>If you try to load a Signal Studio waveform “*.wfm” which contains invalid waveform header, an error is generated.</p>

If the ARB is ON when you load a file to ARB memory or delete a file from ARB memory, the playing waveform segment may not keep phase continuity during the ARB memory operation. The waveform will be replayed after the ARB operation is finished.

ARB can be loaded into ARB memory even if required licenses do not present on the instrument. In this case, a GUI only warning message -800, "Operation complete; Loaded <filename> successfully, but no license <required licenses> installed". User can install required licenses according to <required licenses> string to license it, or multi-pack license it.

Initial S/W Revision A.05.00

Load All To ARB Memory

Allows you to load all the segment files within the currently selected directory into ARB memory. If a file of the same name already exists within ARB memory, it is overwritten. If you wish to load two segments of the same name, you must rename one of the segments before loading it into ARB memory. To rename a segment, you can either use Windows File Explorer, or the :MEMory:COpy command.

NOTE: When a waveform file is loaded to ARB memory, burst timing adjustments are made automatically, based on whether or not a Multiport Adapter is connected to the test set and powered on. If the connection/power status of the Multiport Adapter is changed after a waveform file has been loaded, it needs to be loaded again.

Key Path Source, Modulation Setup, ARB, Select Waveform, Segments on Hard Disk

Remote Command :SOURce:RADio:ARB:LOAD:ALL <string>

Example :SOUR:RAD:ARB:LOAD:ALL "D: varb"

Notes <string> - specifies the directory on the HDD to load the files into ARB memory from.

When in Sequence Analyzer mode, and Include Source is Yes, an attempt to load all files from a directory to ARB memory is rejected with an error.

When Include Source is No and there is insufficient free ARB memory to load all the waveforms, when the ARB memory is full, the copy ceases, and an error is generated.

If you specify a directory over SCPI, but the directory does not exist, an error is generated.

If the ARB is ON, a user then loads or deletes file to ARB memory, the playing waveform segment may not keep phase continuity during the ARB memory operation. The waveform will be replayed after the ARB operation is finished.

Initial S/W Revision A.05.00

Change Directory...

Allows you to change the currently selected directory on the hard disk. Pressing this key opens a standard windows change directory dialog allowing you to select the new directory of interest.

The current directory is used for manually loading waveform segments into ARB memory for playback, and as a search location for waveform segments that are required to be loaded into ARB memory for playback of a waveform sequence or a list sequence.

Key Path	Source, Modulation Setup, ARB, Select Waveform, Segments on Hard Disk
Notes	No remote command, SCPI front panel only.
Initial S/W Revision	A.05.00

Default Directory...

Allows you to change the default directory. It is used as a search location for waveform segments that are required to be loaded into ARB memory for playback of a waveform sequence, and as a search location for selecting waveforms using SCPI.

Key Path	Source, Modulation Setup, ARB, Select Waveform, Segments on Hard Disk
Remote Command	:SOURce:RADio:ARB:DEFault:DIRectory <string> :SOURce:RADio:ARB: DEFault:DIRectory?
Example	:SOUR:RAD:ARB:DEF:DIR "D:\ArbFiles" :SOUR:RAD:ARB:DEF:DIR?
State Saved	Persistent, survives a power cycle and a preset but not saved in the instrument state
Initial S/W Revision	A.05.00

Segments in ARB Memory

Allows you access to the sub-menus for managing the files within ARB memory.

Key Path	Source, Modulation Setup, ARB, Select Waveform
Initial S/W Revision	A.05.00

Delete Segment From ARB Mem

Allows you to remove a segment from ARB playback memory.

Key Path	Source, Modulation Setup, ARB, Select Waveform, Segments in ARB Memory
Remote Command	:SOURce:RADio:ARB:DELete <string>
Example	:SOUR:RAD:ARB:DEL "testwaveform.bin"
Notes	<string> - specifies the waveform to be deleted from the ARB playback memory. When in Sequence Analyzer mode and Include Source is Yes, an attempt to delete a file from ARB memory is rejected with an error. When Include Source is No and you specify a file that does not exist within ARB memory, an error is generated. It is possible to delete files from within the ARB memory when the ARB is ON. However, if you attempt to delete the file that is currently playing an error is generated. It is possible to delete a file from within the ARB memory when the sequencer state is ON and the file is not being used by the List Sequencer. If you attempt to delete a file which is being used by the list

sequencer, an error is generated.

When sequencer state is On, even if ARB state is On, the selected waveform will not be played. In this case, if the selected waveform is not used in List Sequence, it can be deleted and the ARB state is turned Off.

If the ARB is ON and you load a file to ARB memory or delete a file from ARB memory, the playing waveform segment may not keep phase continuity during the ARB memory operation. The waveform will be replayed after the ARB operation is finished.

Initial S/W Revision A.05.00

Delete All From ARB Memory

Allows you to remove all segments from ARB playback memory.

Key Path Source, Modulation Setup, ARB, Select Waveform, Segments in ARB Memory

Remote Command :SOURce:RADio:ARB:DELeTe:ALL

Example :SOUR:RAD:ARB:DELeTe:ALL

Notes

When in Sequence Analyzer mode and Include Source is Yes, an attempt to delete all files from ARB memory is rejected with an error.

When Include Source is No and you attempt to delete all files from ARB memory when the ARB is currently playing a file, all files except the one playing are deleted and an error is generated.

If you attempt to delete all files from ARB memory when there are waveform files used in "[List Sequencer](#)" on page 2168 and "[Sequencer](#)" on page 2168 state is ON, all files except the files currently being used in list sequencer are deleted, and an error is generated.

If the ARB is ON and you load a file to ARB memory or delete a file from ARB memory, the playing waveform segment may not keep phase continuity during the ARB memory operation. The waveform will be replayed after the ARB operation is finished.

Initial S/W Revision A.05.00

Edit Selected Waveform

Allows access to the sub-menus for editing the details of the currently selected waveform segment.

Key Path Source, Modulation Setup, ARB, Waveform Sequences, Build New Sequence

Notes No remote command, front panel only.

Initial S/W Revision A.05.00

Repetitions

Allows you to specify the number of times the currently selected waveform is played within the sequence.

Key Path Source, Modulation Setup, ARB, Waveform Sequences, Build New Sequence, Edit Selected Waveform

Notes	No remote command, SCPI front panel only.
Preset	1
Min	1
Max	65535
Initial S/W Revision	A.05.00

Marker 1

Allows you to enable or disable marker 1 for the currently selected waveform. For a waveform sequence, you can enable and disable markers on a per-segment basis, allowing you to output markers from some waveform segments within the sequence, but not for others.

Key Path	Source, Modulation Setup, ARB, Waveform Sequences, Build New Sequence, Edit Selected Waveform
Notes	No remote command, front panel only.
Preset	Enabled
Range	Enabled Disabled
Initial S/W Revision	A.05.00

Marker 2

Allows you to enable or disable marker 2 for the currently selected waveform. For a waveform sequence, you can enable and disable markers on a per-segment basis, allowing you to output markers from some waveform segments within the sequence, but not for others.

Key Path	Source, Modulation Setup, ARB, Waveform Sequences, Build New Sequence, Edit Selected Waveform
Notes	No remote command, front panel only.
Preset	Enabled
Range	Enabled Disabled
Initial S/W Revision	A.05.00

Marker 3

Allows you to enable or disable marker 3 for the currently selected waveform. For a waveform sequence, you can enable and disable markers on a per-segment basis, allowing you to output markers from some waveform segments within the sequence, but not for others.

Key Path	Source, Modulation Setup, ARB, Waveform Sequences, Build New Sequence, Edit Selected Waveform
----------	---

Notes	No remote command, front panel only.
Preset	Enabled
Range	Enabled Disabled
Initial S/W Revision	A.05.00

Marker 4

Allows you to enable or disable marker 4 for the currently selected waveform. For a waveform sequence, you can enable and disable markers on a per-segment basis, allowing you to output markers from some waveform segments within the sequence, but not for others.

Key Path	Source, Modulation Setup, ARB, Waveform Sequences, Build New Sequence, Edit Selected Waveform
Notes	No remote command, front panel only.
Preset	Enabled
Range	Enabled Disabled
Initial S/W Revision	A.05.00

Delete Segment

Allows you to delete the selected segment from the waveform sequence.

Key Path	Source, Modulation Setup, ARB, Waveform Sequences, Build New Sequence
Notes	No remote command, front panel only.
Initial S/W Revision	A.05.00

Save Sequence...

Pressing this key displays the “Save As” dialog. The sequence name is passed to the save as dialog to use as the filename for saving, and the directory the save as dialog will open into is the default waveform directory.

Key Path	Source, Modulation Setup, ARB, Waveform Sequences, Build New Sequence
Initial S/W Revision	A.05.00

Edit Selected Sequence

Allows access to the sub-menus for editing the sequence currently selected within the Waveform Sequence List view. Pressing this key changes the central view area to display the Waveform Sequence Creation and Editing view.

Key Path	Source, Modulation Setup, ARB, Waveform Sequences
Notes	No remote command, front panel only.
Initial S/W Revision	A.05.00

Current Directory...

Allows you to change the currently selected directory on the hard disk. Pressing this key opens a standard windows change directory dialog and allows you to select the new directory of interest.

Key Path	Source, Modulation Setup, ARB, Waveform Sequences
Notes	No remote command, front panel only.
Initial S/W Revision	A.05.00

Waveform Utilities

Allows you access to the waveform utilities sub-menus.

Key Path	Source, Modulation Setup, ARB
Initial S/W Revision	A.05.00

Multi-Pack Licenses

Allows you access to the Multi - Pack License sub-menus. Pressing this key also changes the central view area to display the Multi -Pack License Management view.

On modular instrument like E6630A or E6640A, multi-pack license operations are only allowed on the default module, i.e. “Left” module for E6630A or “TRX1” module for E6640A.

Key Path	Source, Modulation Setup, ARB, Waveform Utilities
Dependencies	This key is only available if there is at least one Multi-pack license installed on the instrument.
Initial S/W Revision	A.05.00

Add Waveform

Pressing this key accesses the Add Waveform sub-menu. It also changes the central display area to display the Multi-Pack License Waveform Add view.

Key Path	Source, Modulation Setup, ARB, Waveform Utilities, Multi-Pack Licenses
Dependencies	This key is only available if there is at least one slot available within at least one multi-pack license.
Initial S/W Revision	A.05.00

Add Waveform

Allows you to add the currently selected waveform segment to a multi-pack license. The new waveform is added to the next available slot regardless of which slot was selected on the Multi-Pack License Management view.

Key Path	Source, Modulation Setup, ARB, Waveform Utilities, Multi-Pack Licenses, Add Waveform
Remote Command	:SYSTem:LKEY:WAVeform:ADD <string> or :SYSTem:LICense[:FPACK]:WAVeform:ADD <string>
Example	SYST:LKEY:WAV:ADD "mywaveform.wfm" or SYST:LIC:WAV:ADD "mywaveform.wfm"
Notes	The second SCPI :SYSTem:LICense[:FPACK]:WAVeform:ADD is provided to be consistent with the style of Keysight signal sources. You can use either one of them. Since adding a waveform segment to a Multi-Pack license causes the license slot to enter the trial period of only 48 hours, pressing this key causes a confirmation dialog to be displayed to ensure you do want to add the waveform segment to the Multi-Pack. If you attempt to license a waveform that is already licensed using another slot an error is generated. .
Dependencies	This key is only available if the currently selected file is a secure waveform requiring a license, and there is at least one slot available within at least one multi-pack license. If the waveform highlighted is a secure waveform, but is already licensed, this key will be unavailable.
Initial S/W Revision	A.05.00

Segments on Hard Disk

Allows you access to the sub-menus for loading waveform segments from the hard disk into ARB memory. The default directory is: D: varb.

Pressing this key changes the current view to the Waveform Management View.

Key Path	Source, Modulation Setup, ARB, Select Waveform
Initial S/W Revision	A.05.00

Load Segment To ARB Memory

Allows you to load the selected file into ARB memory. On the front panel you select the file for loading to the ARB memory by highlighting the desired file in the list. Using the SCPI command, you specify the file name on the HDD.

“NVWFM” (none-volatile storage) MSUS (Mass Storage Unit Specifier) is supported in the memory subsystem because the ARB memory cannot be accessed directly. Therefore, files must be downloaded to the instrument hard disk and then loaded into the ARB memory. “NVWFM” MSUS will be mapped to the

default directory D: VARB. The SCPI command supports using either “NVWFM” MSUS or specifying a full path. For more information, see Memory Subsystem (Remote Command Only).

If a file of the same name already exists within ARB memory, it is overwritten. If you wish to load two segments of the same name, you must rename one of the segments before loading it into ARB memory. To rename a segment, you can either use Windows File Explorer, or the :MMEMory:COPY command.

NOTE: When a waveform file is loaded to ARB memory, burst timing adjustments are made automatically, based on whether or not a Multiport Adapter is connected to the test set and powered on. If the connection/power status of the Multiport Adapter is changed after a waveform file has been loaded, it needs to be loaded again.

Key Path	Source, Modulation Setup, ARB, Select Waveform, Segments on Hard Disk
Remote Command	:SOURce:RADio:ARB:LOAD <string>
Example	:SOUR:RAD:ARB:LOAD “D: VARB\testwaveform.bin” or :SOUR:RAD:ARB:LOAD “NVWFM:testwaveform.bin”
Notes	<p>Because loading the file involves a delay of unpredictable length, this command should be followed by the query *OPC?, which holds off subsequent commands until the loading operating is complete.</p> <p><string> – specifies the path name of the file to load from the HDD into ARB memory. It could be a <full path + filename>, or <“NVWFM” MSUS + colon + filename>.</p> <p>When in Sequence Analyzer mode, and Include Source is Yes, an attempt to load a file to ARB memory will be rejected with an error.</p> <p>When Include Source is Noand if there is insufficient free ARB memory to load the selected waveform, an error is generated. .</p> <p>If you specify a file over SCPI, but the file is not at the specified location, an error is generated.</p> <p>If you try to load a waveform file but the file contains less than 500 IQ sampes, an error is generated.</p> <p>If you try to load a Signal Studio waveform “*.wfm” which contains invalid waveform header, an error is generated.</p> <p>If the ARB is ON when you load afile to ARB memory or delete a file from ARB memory, the playing waveform segment may not keep phase continuity during the ARB memory operation. The waveform will be replayed after the ARB operation is finished.</p> <p>ARB can be loaded into ARB memory even required licenses do not present on the instrument. In this case, a GUI only warning message -800, “Operation complete; Loaded <filename> successfully, but no license <required licenses> installed”. User can install required licenses according to <required licenses> string to license it, or multi-pack license it.</p>
Initial S/W Revision	A.05.00

Load All To ARB Memory

Allows you to load all the segment files within the currently selected directory into ARB memory. If a file of the same name already exists within ARB memory, it is overwritten. If you wish to load two segments of the same name, you must rename one of the segments before loading it into ARB memory. To rename a segment, you can either use Windows File Explorer, or the :MEMory:COPY command.

NOTE: When a waveform file is loaded to ARB memory, burst timing adjustments are made automatically, based on whether or not a Multiport Adapter is connected to the test set and powered on. If the

connection/power status of the Multiport Adapter is changed after a waveform file has been loaded, it needs to be loaded again.

Key Path	Source, Modulation Setup, ARB, Select Waveform, Segments on Hard Disk
Remote Command	:SOURce:RADio:ARB:LOAD:ALL <string>
Example	:SOUR:RAD:ARB:LOAD:ALL "D: varb"
Notes	<p><string> - specifies the directory on the HDD to load the files into ARB memory from.</p> <p>When in Sequence Analyzer mode, and Include Source is Yes, an attempt to load all files from a directory to ARB memory is rejected with an error.</p> <p>When Include Source is No and there is insufficient free ARB memory to load all the waveforms, when the ARB memory is full, the copy ceases, and an error is generated.</p> <p>If you specify a directory over SCPI, but the directory does not exist, an error is generated.</p> <p>If the ARB is ON, a user then loads or deletes file to ARB memory, the playing waveform segment may not keep phase continuity during the ARB memory operation. The waveform will be replayed after the ARB operation is finished.</p>
Initial S/W Revision	A.05.00

Change Directory...

Allows you to change the currently selected directory on the hard disk. Pressing this key opens a standard windows change directory dialog allowing you to select the new directory of interest.

The current directory is used for manually loading waveform segments into ARB memory for playback, and as a search location for waveform segments that are required to be loaded into ARB memory for playback of a waveform sequence or a list sequence.

Key Path	Source, Modulation Setup, ARB, Select Waveform, Segments on Hard Disk
Notes	No remote command, SCPIfront panel only.
Initial S/W Revision	A.05.00

Default Directory...

Allows you to change the default directory. It is used as a search location for waveform segments that are required to be loaded into ARB memory for playback of a waveform sequence, and as a search location for selecting waveforms using SCPI.

Key Path	Source, Modulation Setup, ARB, Select Waveform, Segments on Hard Disk
Remote Command	:SOURce:RADio:ARB:DEFault:DIRectory <string> :SOURce:RADio:ARB: DEFault:DIRectory?
Example	:SOUR:RAD:ARB:DEF:DIR "D:\ArbFiles" :SOUR:RAD:ARB:DEF:DIR?
State Saved	Persistent, survives a power cycle and a preset but not saved in the instrument state
Initial S/W Revision	A.05.00

Replace Waveform

Pressing this key accesses the Replace Waveform submenu. It also changes the central display area to display the Multi-Pack License Waveform Add view.

Key Path	Source, Modulation Setup, ARB, Waveform Utilities, Multi-Pack Licenses
Dependencies	This key is only available if the currently selected slot is in the trial state.
Initial S/W Revision	A.05.00

Replace Waveform

Allows you to replace the waveform in the currently selected slot with the waveform currently selected in the Multi-Pack License Waveform Add view.

Key Path	Source, Modulation Setup, ARB, Waveform Utilities, Multi-Pack Licenses, Replace Waveform
Remote Command	:SYSTem:LKEY:WAVeform:REPLace <int>, <string> or :SYSTem:LICense[:FPACK]:WAVeform:REPLace <int>, <string>
Example	SYST:LKEY:WAV:REPL 1, "myotherwaveform.wfm" or :SYST:LIC:WAV:REPL 1, "myotherwaveform.wfm"
Notes	The second SCPI :SYSTem:LICense[:FPACK]:WAVeform:REPLace is provided to be consistent with the style of Keysight signal sources. You can use either one of them. If you attempt to license a waveform that is already licensed using another slot an error is generated. Waveform slot number <int> is positive. If you attempt to input a slot number less than or equals 0, an error is generated.
Initial S/W Revision	A.05.00

Clear Waveform from Slot

Allows you to clear the waveform from the selected slot.

Key Path	Source, Modulation Setup, ARB, Waveform Utilities, Multi-Pack Licenses
Remote Command	:SYSTem:LKEY:WAVeform:CLEar <int> or :SYSTem:LICense[:FPACK]:WAVeform:CLEar <int>
Example	SYST:LKEY:WAV:CLE 1 or :SYST:LIC:WAV:CLE 1
Notes	The second SCPI :SYSTem:LICense[:FPACK]:WAVeform:CLEar is provided to be consistent with the style of Keysight signal sources. You can use either one of them. Waveform slot number <int> is positive. If you attempt to input a slot number less than or equals 0, an

error is generated.

Dependencies	This key is only available if the currently selected slot is in the trial state.
Initial S/W Revision	A.05.00

Lock Waveform in Slot

If the selected slot is in the trial state or the lock required state, the waveform that occupies the slot is locked and permanently licensed.

Key Path	Source, Modulation Setup, ARB, Waveform Utilities, Multi-Pack Licenses
----------	--

Remote Command	:SYSTem:LKEY:WAVeform:LOCK <int> or :SYSTem:LICense[:FPACK]:WAVeform:LOCK <int>
----------------	---

Example	SYST:LKEY:WAV:LOCK 1 or SYST:LIC:WAV:LOCK 1
---------	---

Notes	The second SCPI :SYSTem:LICense[:FPACK]:WAVeform:LOCK is provided to be consistent with the style of Keysight signal sources. You can use either one of them. Waveform slot number <int> is positive. If you attempt to input a slot number less than or equals 0, an error is generated.
-------	--

Dependencies	This key is only available if the currently selected slot is in the trial state or the lock required state.
Initial S/W Revision	A.05.00

Marker Utilities

Allows access to the marker utilities sub-menus.

Key Path	Source, Modulation Setup, ARB
Initial S/W Revision	A.05.00

Marker Polarity

Allows access to the marker polarity sub-menu, which allows you to specify the polarity for the four markers. For a positive polarity, the marker signal is high during the marker points. For a negative marker polarity, the marker signal is high during the period of no marker points.

Key Path	Source, Modulation Setup, ARB, Marker Utilities
Initial S/W Revision	A.05.00

Mkr 1 Polarity

Allows you to set the polarity of marker 1.

Key Path	Source, Modulation Setup, ARB, Marker Utilities, Marker Polarity
Remote Command	:SOURce:RADio:ARB:MPOLarity:MARKer1 POSitive NEGative :SOURce:RADio:ARB:MPOLarity:MARKer1?
Example	:SOUR:RAD:ARB:MPOL:MARK1 NEG
Dependencies	When a new waveform is selected for playback the settings contained within the associated waveform header file are applied to the ARB. The marker polarity is one of the values stored within the header file. If the newly selected waveform file has an associated header file, the marker polarity is updated with the value from the header file. The marker polarity will remain unchanged if the newly selected waveform does not have an associated header file.
Preset	Pos
Range	Neg Pos
Initial S/W Revision	A.05.00

Mkr 2 Polarity

Allows you to set the polarity of marker 2.

Key Path	Source, Modulation Setup, ARB, Marker Utilities, Marker Polarity
Remote Command	:SOURce:RADio:ARB:MPOLarity:MARKer2 POSitive NEGative :SOURce:RADio:ARB:MPOLarity:MARKer2?
Example	:SOUR:RAD:ARB:MPOL:MARK2 NEG
Dependencies	When a new waveform is selected for playback the settings contained within the associated waveform header file are applied to the ARB. The marker polarity is one of the values stored within the header file. If the newly selected waveform file has an associated header file, the marker polarity is updated with the value from the header file. The marker polarity will remain unchanged if the newly selected waveform does not have an associated header file.
Preset	Pos
Range	Neg Pos
Initial S/W Revision	A.05.00

Mkr 3 Polarity

Allows you to set the polarity of marker 3.

Key Path	Source, Modulation Setup, ARB, Marker Utilities, Marker Polarity
Remote Command	:SOURce:RADio:ARB:MPOLarity:MARKer3 POSitive NEGative :SOURce:RADio:ARB:MPOLarity:MARKer3?
Example	:SOUR:RAD:ARB:MPOL:MARK3 NEG
Dependencies	When a new waveform is selected for playback the settings contained within the associated

	waveform header file are applied to the ARB. The marker polarity is one of the values stored within the header file. If the newly selected waveform file has an associated header file, the marker polarity is updated with the value from the header file. The marker polarity will remain unchanged if the newly selected waveform does not have an associated header file.
Preset	Pos
Range	Neg Pos
Initial S/W Revision	A.05.00

Mkr 4 Polarity

Allows you to set the polarity of marker 4.

Key Path	Source, Modulation Setup, ARB, Marker Utilities, Marker Polarity
Remote Command	:SOURce:RADio:ARB:MPOLarity:MARKer4 POSitive NEGative :SOURce:RADio:ARB:MPOLarity:MARKer4?
Example	:SOUR:RAD:ARB:MPOL:MARK4 NEG
Dependencies	When a new waveform is selected for playback the settings contained within the associated waveform header file are applied to the ARB. The marker polarity is one of the values stored within the header file. If the newly selected waveform file has an associated header file, the marker polarity is updated with the value from the header file. The marker polarity will remain unchanged if the newly selected waveform does not have an associated header file.
Preset	Pos
Range	Neg Pos
Initial S/W Revision	A.05.00

Marker Routing

Allows access to the marker routing sub-menus, which allow you to specify where the marker events are routed. It should be noted that the markers can also be routed to Trigger 1 Out and Trigger 2 Out, however this must be set up using the menus accessed by pressing the “Trigger” hard key.

Key Path	Source, Modulation Setup, ARB, Marker Utilities
Initial S/W Revision	A.05.00

Pulse/RF Blank

Allows you to select which marker is used for the pulse/RF blanking function. The pulse/RF blanking function blanks the RF when the marker signal goes low. The marker polarity determines when the marker signal is high. For a positive polarity, this is during the marker points. For a negative polarity, this is when there are no marker points.

Marker points should be set before using this function. Enabling this function without setting maker points may create a continuous low or high signal, dependant on the marker polarity. This causes either no RF output, or a continuous RF output.

Key Path	Source, Modulation Setup, ARB, Marker Utilities, Marker Routing
Remote Command	:SOURce:RADio:ARB:MDEStination:PULSe NONE M1 M2 M3 M4 :SOURce:RADio:ARB:MDEStination:PULSe?
Example	:SOUR:RAD:ARB:MDES:PULS NONE
Dependencies	When a new waveform is selected for playback the settings contained within the associated waveform header file are applied to the ARB. The pulse/RF blanking setting is one of the values stored within the header file. If the newly selected waveform file has an associated header file, the pulse/RF blanking setting is updated with the value from the header file. The pulse/RF blanking setting will remain unchanged if the newly selected waveform does not have an associated header file.
Range	None M1 M2 M3 M4
Initial S/W Revision	A.05.00

None

Sets no marker to be used for the pulse/RF blanking function, essentially turning the RF blanking function off.

Key Path	Source, Modulation Setup, ARB, Marker Utilities, Marker Routing, Pulse/RF Blank
Example	:SOUR:RAD:ARB:MDES:PULS NONE
Initial S/W Revision	A.05.00

Marker 1

Sets marker 1 to be used for the pulse/RF blanking function.

Key Path	Source, Modulation Setup, ARB, Marker Utilities, Marker Routing, Pulse/RF Blank
Example	:SOUR:RAD:ARB:MDES:PULS M1
Initial S/W Revision	A.05.00

Marker 2

Sets marker 2 to be used for the pulse/RF blanking function.

Key Path	Source, Modulation Setup, ARB, Marker Utilities, Marker Routing, Pulse/RF Blank
Example	:SOUR:RAD:ARB:MDES:PULS M2
Initial S/W Revision	A.05.00

Marker 3

Sets marker 3 to be used for the pulse/RF blanking function.

Key Path	Source, Modulation Setup, ARB, Marker Utilities, Marker Routing, Pulse/RF Blank
Example	:SOUR:RAD:ARB:MDES:PULS M3
Initial S/W Revision	A.05.00

Marker 4

Sets marker 4 to be used for the pulse/RF blanking function.

Key Path	Source, Modulation Setup, ARB, Marker Utilities, Marker Routing, Pulse/RF Blank
Example	:SOUR:RAD:ARB:MDES:PULS M4
Initial S/W Revision	A.05.00

ALC Hold

Allows you to specify which marker is routed for use within the ALC hold function. The ALC hold marker function holds the ALC circuitry at the average value of the sample points set by the marker.

The ALC hold function operates during the low periods of the marker signal. The marker polarity determines when the marker signal is high. For positive polarity, this is during the marker points. For a negative polarity, this is when there are no marker points.

Key Path	Source, Modulation Setup, ARB, Marker Utilities, Marker Routing
Remote Command	:SOURce:RADio:ARB:MDEStination:ALCHold NONE M1 M2 M3 M4 :SOURce:RADio:ARB:MDEStination:ALCHold?
Example	:SOUR:RAD:ARB:MDES:ALCH NONE
Dependencies	When a new waveform is selected for playback the settings contained within the associated waveform header file are applied to the ARB. The ALC hold setting is one of the values stored within the header file. If the newly selected waveform file has an associated header file, the ALC hold setting is updated with the value from the header file. The ALC hold setting will remain unchanged if the newly selected waveform does not have an associated header file.
Range	None M1 M2 M3 M4
Initial S/W Revision	A.05.00

None

Sets no marker to be used for the ALC hold function, essentially turning the ALC hold function off.

Key Path	Source, Modulation Setup, ARB, Marker Utilities, Marker Routing, ALC Hold
Example	:SOUR:RAD:ARB:MDES:PULS NONE
Initial S/W Revision	A.05.00

Marker 1

Sets marker 1 to be used for the ALC hold function.

Key Path	Source, Modulation Setup, ARB, Marker Utilities, Marker Routing, ALC Hold
Example	:SOUR:RAD:ARB:MDES:PULS M1
Initial S/W Revision	A.05.00

Marker 2

Sets marker 2 to be used for the ALC hold function.

Key Path	Source, Modulation Setup, ARB, Marker Utilities, Marker Routing, ALC Hold
Example	:SOUR:RAD:ARB:MDES:PULS M2
Initial S/W Revision	A.05.00

Marker 3

Sets marker 3 to be used for the ALC hold function.

Key Path	Source, Modulation Setup, ARB, Marker Utilities, Marker Routing, ALC Hold
Example	:SOUR:RAD:ARB:MDES:PULS M3
Initial S/W Revision	A.05.00

Marker 4

Sets marker 4 to be used for the ALC hold function.

Key Path	Source, Modulation Setup, ARB, Marker Utilities, Marker Routing, ALC Hold
Example	:SOUR:RAD:ARB:MDES:PULS M4
Initial S/W Revision	A.05.00

Header Utilities

Allows access to the header utilities sub-menu. Pressing this key also causes the central display area to change to display the File Header Information view.

Key Path	Source, Modulation Setup, ARB
Dependencies	This key is only available if there is currently a waveform selected for playback. If no waveform is selected, the key is grayed out.
Initial S/W Revision	A.05.00

Clear Header

Allows you to clear the header information from the file header associated with the currently selected waveform.

Key Path	Source, Modulation Setup, ARB, Header Utilities
Remote Command	:SOURce:RADio:ARB:HEADer:CLEar
Example	:SOUR:RAD:ARB:HEAD:CLE
Notes	Attempting to clear the header details via SCPI when no waveform was selected for playback will generate an error.
Initial S/W Revision	A.05.00

Save Setup To Header

Allows you to save new file header information details to the file.

Key Path	Source, Modulation Setup, ARB, Header Utilities
Remote Command	:SOURce:RADio:ARB:HEADer:SAVE
Example	:SOUR:RAD:ARB:HEAD:SAVE
Notes	Attempting to save the header details via SCPI when no waveform was selected for playback will generate an error.
Initial S/W Revision	A.05.00

AM

Allows access to the menu for configuring the Amplitude Modulation.

Key Path	Source, Modulation Setup
Initial S/W Revision	A.05.00

AM

Enables or disables the amplitude modulation.

Turning AM on when another modulation format is already on results in the previous modulation format being turned off and the generation of an error.

Key Path	Source, Modulation Setup, AM
Remote Command	:SOURce:AM:STATe :SOURce:AM:STATe?
Example	:SOUR:AM:STAT OFF

Preset	Off
Range	On Off
Initial S/W Revision	A.05.00

AM Depth

Allows you to set the amplitude modulation depth in percent.

Key Path	Source, Modulation Setup, AM
Remote Command	:SOURce:AM[:DEPTh] [:LINear] :SOURce:AM[:DEPTh] [:LINear]?
Example	:SOUR:AM 0.1
Preset	0.1 %
Min	0.1 %
Max	95.0 %
Initial S/W Revision	A.05.00

AM Rate

Allows you to set the internal amplitude modulation rate.

Key Path	Source, Modulation Setup, AM
Remote Command	:SOURce:AM:INTernal:FREQuency :SOURce:AM:INTernal:FREQuency?
Example	:SOUR:AM:INT:FREQ 40.0 Hz
Preset	400.0 Hz
Min	10 Hz
Max	40 kHz
Initial S/W Revision	A.05.00

FM

Allows access to the menu for configuring the frequency modulation.

Key Path	Source, Modulation Setup
Initial S/W Revision	A.05.00

FM

Enables or disables the frequency modulation.

Turning FM on when another modulation format is already on results in the previous modulation format being turned off and the generation of an error.

Key Path	Source, Modulation Setup, FM
Remote Command	:SOURce:FM:STATe :SOURce:FM:STATe?
Example	:SOUR:FM:STAT OFF
Preset	Off
Range	On Off
Initial S/W Revision	A.05.00

FM Deviation

Allows you to set the frequency modulation deviation.

Key Path	Source, Modulation Setup, FM
Remote Command	:SOURce:FM[:DEVIation] :SOURce:FM[:DEVIation]?
Example	:SOUR:FM 1.00 kHz
Preset	1.00 Hz
Min	1.00 Hz
Max	100.00 kHz
Initial S/W Revision	A.05.00

FM Rate

Allows you to set the internal frequency modulation rate.

Key Path	Source, Modulation Setup, FM
Remote Command	:SOURce:FM:INTernal:FREQuency :SOURce:FM:INTernal:FREQuency?
Example	:SOUR:FM:INT:FREQ 40.0 Hz
Preset	400.0 Hz
Min	10 Hz
Max	40 kHz
Initial S/W Revision	A.05.00

PM

Allows access to the menu for configuring the phase modulation.

Key Path	Source, Modulation Setup
Initial S/W Revision	A.05.00

PM

Enables or disables the phase modulation.

Turning PM on when another modulation format is already on results in the previous modulation format being turned off and the generation of an error.

Key Path	Source, Modulation Setup, PM
Remote Command	:SOURce:PM:STATe :SOURce:PM:STATe?
Example	:SOUR:PM:STAT OFF
Preset	Off
Range	On Off
Initial S/W Revision	A.05.00

PM Deviation

Allows you to set the phase modulation deviation.

Key Path	Source, Modulation Setup, PM
Remote Command	:SOURce:PM[:DEViation] :SOURce:PM[:DEViation]?
Example	:SOUR:PM 1.00 rad
Preset	0.1 rad
Min	0.1 rad
Max	20.0 rad
Initial S/W Revision	A.05.00

PM Rate

Allows you to set the internal phase modulation rate.

Key Path	Source, Modulation Setup, PM
Remote Command	:SOURce:PM:INTernal:FREQuency :SOURce:PM:INTernal:FREQuency?

Example	:SOUR:PM:INT:FREQ 40.0 Hz
Preset	400.0 Hz
Min	10 Hz
Max	40 kHz
Initial S/W Revision	A.05.00

List Sequencer

Allows you access to the sub-menus for configuring the list sequencer.

List sequences allows you to enter frequencies and amplitudes at unequal intervals in nonlinear ascending, descending or random order. Each step within the list can also include its own waveform file for playback, step duration, trigger event and trigger output.

The complexities involved in configuring the list sequencer do not lend itself to manual configuration; hence the manual configuration for this feature is limited. For easier configuration of the list sequencer, it is recommended that you use either SCPI or load a tab delimited file containing the setup parameters in a tabular form. The details of the SCPI for configuring the list sequencer can be found in Step Configuration (Remote Command Only).

Once the List Sequencer has been configured using the front panel, SCPI, or loading in a tab delimited file, the sequence must be initiated using the front panel Initiate Sequence key or the corresponding SCPI command.

Key Path	Source
Initial S/W Revision	A.05.00

Sequencer

Allows you to set the state of the list sequencer. When the list sequencer is on, the source is outputting the sequence defined by the sequencer. When the list sequencer is off, the source outputs a single waveform segment or sequence (independent mode) at a single frequency and amplitude.

Key Path	Source, List Sequencer
Remote Command	:SOURce:LIST[:STATe] ON OFF 1 0 :SOURce:LIST[:STATe]?
Example	:SOUR:LIST OFF
Notes	When the sequencer is set to ON, the list sequencer controls the output of the source.
Couplings	When in Sequence Analyzer mode and the list sequencer state is Off, Include Source is forced to No, and the Include Source key is grayed out. When in Sequence Analyzer mode and the list sequencer state is On, Include Source is available to set. And, an ARB memory related operation, like load or delete will be rejected.

Preset	Off
Range	On Off
Initial S/W Revision	A.05.00

Initiate Sequence

Pressing this key arms the sequence for single execution. Once the sequence is armed the source begins the sequence as soon as the trigger is received. If the trigger is set to Free Run, the sequence starts immediately.

Key Path	Source, List Sequencer
Remote Command	:SOURce:LIST:TRIGger[:IMMediate]
Example	:SOUR:LIST:TRIG
Notes	<p>When in Sequence Analyzer mode and Include Source is Yes, the Initiate list sequencer operation is rejected, and the key is grayed out, since source list sequence request is sent to physics via Parallel batch by sequence analyzer.</p> <p>If the file needed by the sequencer is not already in ARB memory, the sequence cannot be initiated and an error will be generated.</p> <p>There is a blocking SCPI query which can be used to query if source list sequence being initiated successfully or not. (see Query List Sequence Initiation Armed Status (Remote Command Only) Query Source List Sequence Armed Status)</p>
Dependencies	Under the Sequence Analyzer Mode, if Meas Setup->Include Source is set to YES, Source->List Sequencer->Initiate Sequence is disabled.
Initial S/W Revision	A.05.00

List Sequencer Setup

Allows you access to the list sequencer setup menus.

Key Path	Source, List Sequencer
----------	------------------------

Number of Steps

Allows you to specify the number of steps within the list sequence.

Key Path	Source, List Sequencer, List Sequencer Setup
Remote Command	:SOURce:LIST:NUMBer:STEPs <integer> :SOURce:LIST:NUMBer:STEPs?
Example	:SOUR:LIST:NUMB:STEP 1
Notes	Increasing the number of steps creates additional steps at the end of the list, with all the settings

	within the steps set to their default values. Decreasing the number of steps removes steps from the end of the list. The settings within the removed steps are not reset. This means that increasing the number of steps again would allow you to retrieve these steps.
Dependencies	The Step Count parameter is increased or decreased when you insert or delete a point from within the GUI interface to the sequencer.
Preset	1
Min	1
Max	1000
Initial S/W Revision	A.05.00

Current Step

Allows you to select the step number you wish to view or edit.

Key Path	Source, List Sequencer, List Sequencer Setup
Notes	No remote command, front panel only.
Preset	1
Min	1
Max	Step Count
Initial S/W Revision	A.05.00

Insert Step Before

Allows you to insert a new step, containing default values, before the currently selected step. Inserting a step will automatically increase the Step Count parameter by 1. If sequence already reaches upper limit of 1000 steps, then insert more step will be rejected and popup error –221, “Setting Conflict; Cannot insert more steps, maximum number of steps reached”

Key Path	Source, List Sequencer, List Sequencer Setup
Notes	No remote command, front panel only. If the list already contains the maximum limit of 1000 steps, no operation will be made after pressing this key.
Initial S/W Revision	A.05.00

Delete Step

Allows you to delete the current step. Deleting a step will automatically decrease the Step Count parameter by 1. If sequence only has one step left, delete step will be rejected and popup error –221, “Setting conflict; Cannot delete current step, minimum number of steps reached”

Key Path	Source, List Sequencer, List Sequencer Setup
Notes	No remote command, Front Panel key only. If the list already contains the minimum limit of 1 step, no operation will be made after pressing this key
Initial S/W Revision	A.05.00

Clear List

Allows you to clear the list. Clearing the list sets the number of steps to the default value of 1 and sets the parameters for the only step to their default values.

Key Path	Source, List Sequencer, List Sequencer Setup
Initial S/W Revision	A.05.00

Step Trigger

Allows access to the sub-menu for selecting the trigger input for the current step.

Key Path	Source, List Sequencer, List Sequencer Setup
Remote Command	:SOURce:LIST:STEP[1] 2 3...1000:SETup:INPut:TRIGger IMMEDIATE INTERNAL EXTERNAL2 KEY BUS EXTERNAL4 :SOURce:LIST:STEP[1] 2 3...1000:SETup:INPut:TRIGger?
Example	:SOUR:LIST:STEP2:SET:INP:TRIG BUS :SOUR:LIST:STEP2:SET:INP:TRIG?
Notes	SCPI is supported after A.09.40
Preset	Free Run
Range	Free Run Internal Manual (Trigger Key) Bus External 2 EXTERNAL4
Initial S/W Revision	A.05.00

Free Run

Sets the trigger input for the current step to Free Run.

Key Path	Source, List Sequencer, List Sequencer Setup, Step Trigger
Example	:SOUR:LIST:STEP2:SET:INP:TRIG IMM
Notes	SCPI is supported after A.09.40
Initial S/W Revision	A.05.00

Internal

Sets the trigger input for the current step to Internal.

Key Path	Source, List Sequencer, List Sequencer Setup, Step Trigger
Example	:SOUR:LIST:STEP2:SET:INP:TRIG INT
Notes	SCPI is supported after A.09.40
Initial S/W Revision	A.05.00

Manual (Trigger Key)

Sets the trigger input for the current step to Manual (Trigger Key). Any step in the sequence set to Manual will cause the sequence execution to stop until the manual trigger key is pressed. Sending the Bus Trigger SCPI command will have no effect. At any point in the sequence where the list sequencer is paused waiting for a software trigger, a pop up dialog is displayed until the trigger event occurs.

Key Path	Source, List Sequencer, List Sequencer Setup, Step Trigger
Example	:SOUR:LIST:STEP2:SET:INP:TRIG KEY
Notes	SCPI is supported after A.09.40
Initial S/W Revision	A.05.00

Bus

Sets the trigger input for the current step to Bus. Any step in the sequence set to Bus will cause the sequence execution to stop until the Bus Trigger SCPI command is sent. Pressing the manual trigger key has no effect. At any point in the sequence where the list sequencer is paused waiting for a software trigger, a pop up dialog is displayed until the trigger event occurs.

Key Path	Source, List Sequencer, List Sequencer Setup, Step Trigger
Example	:SOUR:LIST:STEP2:SET:INP:TRIG BUS
Notes	SCPI is supported after A.09.40
Initial S/W Revision	A.05.00

External 2

Sets the trigger input for the current step to External 2.

Key Path	Source, List Sequencer, List Sequencer Setup, Step Trigger
Example	:SOUR:LIST:STEP2:SET:INP:TRIG EXT2
Notes	SCPI is supported after A.09.40
Notes	Note: When on E6640A, trigger 2 is a bi-directional trigger port. So when trigger 2 has been configured as OUTPUT type, choosing External 2 as the input trigger for the current step will generate error.
Initial S/W Revision	A.05.00

Transition Time

Allows you to specify the transition time for the current step.

The transition time is the amount of time allowed for the source to settle at the current frequency or amplitude value.

Transition Time should not be taken as additional time before or inside the Step Duration. You can set a value for the settling time to allow the source output frequency or amplitude to become stable. Make sure that during this period of time, you do not use the source output signal.

The following table lists recommended values for appropriate settling times to allow for changes within the source.

Value Changed	Recommended Transition Time
Frequency	500 μ s
Amplitude	100 μ s to within 0.1 dB 20 μ s to within 1.0 dB

If the Transition Time value is shorter than the time necessary for the hardware to settle and a List Sequence is initiated, a **warning** is generated.

If the Transition Time value is longer than the Step Duration, an error is generated when initiating a source list sequence. For source list sequence, transition time is included in the step duration length. If the Transition Time value is longer than the Step Duration Time, the real step duration length is extended to equal the transition time and cause a timing shift.

Key Path	Source, List Sequencer, List Sequencer Setup
Remote Command	:SOURce:LIST:STEP[1] 2 3...1000:SETup:TRANSition:TIME <time> :SOURce:LIST:STEP[1] 2 3...1000:SETup:TRANSition:TIME?
Example	:SOUR:LIST:STEP2:SET:TRAN:TIME 1ms :SOUR:LIST:STEP2:SET:TRAN:TIME?
Notes	SCPI is supported after A.09.40
Preset	1.0 ms
Min	0.0 ms
Max	4.0 ks
Initial S/W Revision	A.05.00

Radio Setup

Allows you access to the sub-menus for setting up the radio standard, band, and radio band link direction for the current step.

Key Path	Source, List Sequencer, List Sequencer Setup
Notes	No remote command, front panel only.

Initial S/W Revision	A.05.00
----------------------	---------

Radio Standard

Allows access to the sub-menus for selecting the radio standard and the associated radio band for use in the current step.

Key Path	Source, List Sequencer, List Sequencer Setup, Radio Setup
Remote Command	:SOURce:LIST:STEP[1] 2 3...1000:SETup:RADio:BAND NONE PGSM EGSM RGSM DCS1800 PCS1900 TGSM810 GSM450 GSM480 GSM700 GSM850 BANDI BANDII BANDIII BANDIV BANDV BANDVI BANDVII BANDVIII BANDIX BANDX BANDXI BANDXII BANDXIII BANDXIV BANDXIX USCELL USPCS JAPAN KOREAN NMT IMT2K UPPER SECOND PAMR400 PAMR800 IMTEXT PCS1DOT9G AWS US2DOT5G PUBLIC LOWER NONE BAND1 BAND2 BAND3 BAND4 BAND5 BAND6 BAND7 BAND8 BAND10 BAND11 BAND12 BAND13 BAND14 BAND17 BAND18 BAND19 BAND20 BAND21 BAND24 BAND25 BAND26 BAND27 BAND28 BAND29 BAND30 BAND31 BAND33 BAND34 BAND35 BAND36 BAND37 BAND38 BAND39 BAND40 BAND41 BAND42 BAND43 BAND44 BANDA BANDB BANDC BANDD BANDE BANDF :SOURce:LIST:STEP[1] 2 3...1000:SETup: RADio:BAND?

Example	:SOUR:LIST:STEP2:SET:RAD:BAND PGSM :SOUR:LIST:STEP2:SET:RAD:BAND?
----------------	--

Notes	SCPI is supported after A.09.40
-------	---------------------------------

Initial S/W Revision	A.05.00
----------------------	---------

None

Selects no radio standard for use on the current step.

Key Path	Source, List Sequencer, List Sequencer Setup, Radio Setup, Radio Standard
-----------------	---

Example	:SOUR:LIST:STEP2:SET:RAD:BAND NONE
----------------	------------------------------------

Notes	SCPI is supported after A.09.40
-------	---------------------------------

Initial S/W Revision	A.05.00
----------------------	---------

GSM/EDGE

Pressing this key once selects GSM/EDGE as the radio standard and the current GSM/EDGE band as the active channel band. Pressing this key again allows access to the sub-menus for selecting a different GSM/EDGE band.

Key Path	Source, List Sequencer, List Sequencer Setup, Radio Setup, Radio Standard
-----------------	---

Initial S/W Revision	A.05.00
----------------------	---------

P-GSM

Selects P-GSM as the band for the current step.

Key Path	Source, List Sequencer, List Sequencer Setup, Radio Setup, Radio Standard, GSM/EDGE
Initial S/W Revision	A.05.00

E-GSM

Selects E-GSM as the band for the current step.

Key Path	Source, List Sequencer, List Sequencer Setup, Radio Setup, Radio Standard, GSM/EDGE
Initial S/W Revision	A.05.00

R-GSM

Selects R-GSM as the band for the current step.

Key Path	Source, List Sequencer, List Sequencer Setup, Radio Setup, Radio Standard, GSM/EDGE
Initial S/W Revision	A.05.00

DCS 1800

Selects DCS 1800 as the band for the current step.

Key Path	Source, List Sequencer, List Sequencer Setup, Radio Setup, Radio Standard, GSM/EDGE
Initial S/W Revision	A.05.00

PCS 1900

Selects PCS 1900 as the band for the current step.

Key Path	Source, List Sequencer, List Sequencer Setup, Radio Setup, Radio Standard, GSM/EDGE
Initial S/W Revision	A.05.00

GSM 450

Selects GSM 450 as the band for the current step.

Key Path	Source, List Sequencer, List Sequencer Setup, Radio Setup, Radio Standard, GSM/EDGE
Initial S/W Revision	A.05.00

GSM 480

Selects GSM 480 as the band for the current step.

Key Path	Source, List Sequencer, List Sequencer Setup, Radio Setup, Radio Standard, GSM/EDGE
Initial S/W Revision	A.05.00

GSM 850

Selects GSM 850 as the band for the current step.

Key Path	Source, List Sequencer, List Sequencer Setup, Radio Setup, Radio Standard, GSM/EDGE
Initial S/W Revision	A.05.00

GSM 700

Selects GSM 700 as the band for the current step.

Key Path	Source, List Sequencer, List Sequencer Setup, Radio Setup, Radio Standard, GSM/EDGE
Initial S/W Revision	A.05.00

T-GSM 810

Selects T-GSM 810 as the band for the current step.

Key Path	Source, List Sequencer, List Sequencer Setup, Radio Setup, Radio Standard, GSM/EDGE
Initial S/W Revision	A.05.00

WCDMA

Pressing this key once selects WCDMA as the radio standard and the current WCDMA band as the active channel band. Pressing this key again allows access to the sub-menus for selecting a different WCDMA band.

Key Path	Source, List Sequencer, List Sequencer Setup, Radio Setup, Radio Standard
Initial S/W Revision	A.05.00

Band I

Selects Band I as the band for the current step.

Key Path	Source, List Sequencer, List Sequencer Setup, Radio Setup, Radio Standard, WCDMA
Initial S/W Revision	A.05.00

Band II

Selects Band II as the band for the current step.

Key Path	Source, List Sequencer, List Sequencer Setup, Radio Setup, Radio Standard, WCDMA
Initial S/W Revision	A.05.00

Band III

Selects Band III as the band for the current step.

Key Path	Source, List Sequencer, List Sequencer Setup, Radio Setup, Radio Standard, WCDMA
Initial S/W Revision	A.05.00

Band IV

Selects Band IV as the band for the current step.

Key Path	Source, List Sequencer, List Sequencer Setup, Radio Setup, Radio Standard, WCDMA
Initial S/W Revision	A.05.00

Band V

Selects Band V as the band for the current step.

Key Path	Source, List Sequencer, List Sequencer Setup, Radio Setup, Radio Standard, WCDMA
Initial S/W Revision	A.05.00

Band VI

Selects Band VI as the band for the current step.

Key Path	Source, List Sequencer, List Sequencer Setup, Radio Setup, Radio Standard, WCDMA
Initial S/W Revision	A.05.00

Band VII

Selects Band VII as the band for the current step.

Key Path	Source, List Sequencer, List Sequencer Setup, Radio Setup, Radio Standard, WCDMA
Initial S/W Revision	A.05.00

Band VIII

Selects Band VIII as the band for the current step.

Key Path	Source, List Sequencer, List Sequencer Setup, Radio Setup, Radio Standard, WCDMA
Initial S/W Revision	A.05.00

Band IX

Selects Band IX as the band for the current step.

Key Path	Source, List Sequencer, List Sequencer Setup, Radio Setup, Radio Standard, WCDMA
Initial S/W Revision	A.05.00

Band X

Selects Band X as the band for the current step.

Key Path	Source, List Sequencer, List Sequencer Setup, Radio Setup, Radio Standard, WCDMA
Initial S/W Revision	A.05.00

Band XI

Selects Band XI as the band for the current step.

Key Path	Source, List Sequencer, List Sequencer Setup, Radio Setup, Radio Standard, WCDMA
Initial S/W Revision	A.05.00

Band XII

Selects Band XII as the band for the current step.

Key Path	Source, List Sequencer, List Sequencer Setup, Radio Setup, Radio Standard, WCDMA
Initial S/W Revision	A.05.00

Band XIII

Selects Band XIII as the band for the current step.

Key Path	Source, List Sequencer, List Sequencer Setup, Radio Setup, Radio Standard, WCDMA
Initial S/W Revision	A.05.00

Band XIV

Selects Band XIV as the band for the current step.

Key Path	Source, List Sequencer, List Sequencer Setup, Radio Setup, Radio Standard, WCDMA
Initial S/W Revision	A.05.00

LTE

Pressing this key once selects LTE FDD as the radio standard and the current LTE FDD band as the active channel band. Pressing this key again allows access to the sub-menus for selecting a different LTE FDD band.

Key Path	Source, List Sequencer, List Sequencer Setup, Radio Setup, Radio Standard
Initial S/W Revision	A.09.50

BAND 1

Selects BAND 1 as the band for the current step.

Key Path	Source, List Sequencer, List Sequencer Setup, Radio Setup, Radio Standard, LTE
Initial S/W Revision	A.09.50

BAND 2

Selects BAND 2 as the band for the current step.

Key Path	Source, List Sequencer, List Sequencer Setup, Radio Setup, Radio Standard, LTE
Initial S/W Revision	A.09.50

BAND 3

Selects BAND 3 as the band for the current step.

Key Path	Source, List Sequencer, List Sequencer Setup, Radio Setup, Radio Standard, LTE
Initial S/W Revision	A.09.50

BAND 4

Selects BAND 4 as the band for the current step.

Key Path	Source, List Sequencer, List Sequencer Setup, Radio Setup, Radio Standard, LTE
Initial S/W Revision	A.09.50

BAND 5

Selects BAND 5 as the band for the current step.

Key Path	Source, List Sequencer, List Sequencer Setup, Radio Setup, Radio Standard, LTE
Initial S/W Revision	A.09.50

BAND 6

Selects BAND 6 as the band for the current step.

Key Path	Source, List Sequencer, List Sequencer Setup, Radio Setup, Radio Standard, LTE
Initial S/W Revision	A.09.50

BAND 7

Selects BAND 7 as the band for the current step.

Key Path	Source, List Sequencer, List Sequencer Setup, Radio Setup, Radio Standard, LTE
Initial S/W Revision	A.09.50

BAND 8

Selects BAND 8 as the band for the current step.

Key Path	Source, List Sequencer, List Sequencer Setup, Radio Setup, Radio Standard, LTE
Initial S/W Revision	A.09.50

BAND 9

Selects BAND 9 as the band for the current step.

Key Path	Source, List Sequencer, List Sequencer Setup, Radio Setup, Radio Standard, LTE
Initial S/W Revision	A.09.50

BAND 10

Selects BAND 10 as the band for the current step.

Key Path	Source, List Sequencer, List Sequencer Setup, Radio Setup, Radio Standard, LTE
Initial S/W Revision	A.09.50

BAND 11

Selects BAND 11 as the band for the current step.

Key Path	Source, List Sequencer, List Sequencer Setup, Radio Setup, Radio Standard, LTE
Initial S/W Revision	A.09.50

BAND 12

Selects BAND 12 as the band for the current step.

Key Path	Source, List Sequencer, List Sequencer Setup, Radio Setup, Radio Standard, LTE
Initial S/W Revision	A.09.50

BAND 13

Selects BAND 13 as the band for the current step.

Key Path	Source, List Sequencer, List Sequencer Setup, Radio Setup, Radio Standard, LTE
Initial S/W Revision	A.09.50

BAND 14

Selects BAND 14 as the band for the current step.

Key Path	Source, List Sequencer, List Sequencer Setup, Radio Setup, Radio Standard, LTE
Initial S/W Revision	A.09.50

BAND 17

Selects BAND 17 as the band for the current step.

Key Path	Source, List Sequencer, List Sequencer Setup, Radio Setup, Radio Standard, LTE
Initial S/W Revision	A.09.50

BAND 18

Selects BAND 18 as the band for the current step.

Key Path	Source, List Sequencer, List Sequencer Setup, Radio Setup, Radio Standard, LTE
Initial S/W Revision	A.09.50

BAND 19

Selects BAND 19 as the band for the current step.

Key Path	Source, List Sequencer, List Sequencer Setup, Radio Setup, Radio Standard, LTE
Initial S/W Revision	A.09.50

BAND 20

Selects BAND 20 as the band for the current step.

Key Path	Source, List Sequencer, List Sequencer Setup, Radio Setup, Radio Standard, LTE
Initial S/W Revision	A.09.50

BAND 21

Selects BAND 21 as the band for the current step.

Key Path	Source, List Sequencer, List Sequencer Setup, Radio Setup, Radio Standard, LTE
Initial S/W Revision	A.09.50

BAND 24

Selects BAND 24 as the band for the current step.

Key Path	Source, List Sequencer, List Sequencer Setup, Radio Setup, Radio Standard, LTE
Initial S/W Revision	A.09.50

BAND 25

Selects BAND 25 as the band for the current step.

Key Path	Source, List Sequencer, List Sequencer Setup, Radio Setup, Radio Standard, LTE
Initial S/W Revision	A.09.50

BAND 26

Selects BAND 26 as the band for the current step.

Key Path	Source, List Sequencer, List Sequencer Setup, Radio Setup, Radio Standard, LTE
Initial S/W Revision	A.12.53

BAND 27

Selects BAND 27 as the band for the current step.

Key Path	Source, List Sequencer, List Sequencer Setup, Radio Setup, Radio Standard, LTE
Initial S/W Revision	A.14.00

BAND 28

Selects BAND 28 as the band for the current step.

Key Path	Source, List Sequencer, List Sequencer Setup, Radio Setup, Radio Standard, LTE
Initial S/W Revision	A.14.00

BAND 31

Selects BAND 31 as the band for the current step.

Key Path	Source, List Sequencer, List Sequencer Setup, Radio Setup, Radio Standard, LTE
Initial S/W Revision	A.14.00

LTE TDD

Sets LTE TDD as the radio standard for use and accesses the LTE TDD specific channel band sub-menus..

Key Path	Source, Frequency, Radio Setup, Radio Standard
Initial S/W Revision	A.11.50

BAND 33

Selects BAND 33 as the band for the current step.

Key Path	Source, Frequency, Radio Setup, Radio Standard, LTE TDD
Example	:SOUR:FREQ:CHAN:BAND BAND33
Initial S/W Revision	A.11.50

BAND 34

Selects BAND 34 as the band for the current step.

Key Path	Source, Frequency, Radio Setup, Radio Standard, LTE TDD
Example	:SOUR:FREQ:CHAN:BAND BAND34
Initial S/W Revision	A.11.50

BAND 35

Selects BAND 35 as the band for the current step.

Key Path	Source, Frequency, Radio Setup, Radio Standard, LTE TDD
Example	:SOUR:FREQ:CHAN:BAND BAND35
Initial S/W Revision	A.11.50

BAND 36

Selects BAND 36 as the band for the current step.

Key Path	Source, Frequency, Radio Setup, Radio Standard, LTE TDD
Example	:SOUR:FREQ:CHAN:BAND BAND36
Initial S/W Revision	A.11.50

BAND 37

Selects BAND 37 as the band for the current step.

Key Path	Source, Frequency, Radio Setup, Radio Standard, LTE TDD
Example	:SOUR:FREQ:CHAN:BAND BAND37
Initial S/W Revision	A.11.50

BAND 38

Selects BAND 38 as the band for the current step.

Key Path	Source, Frequency, Radio Setup, Radio Standard, LTE TDD
Example	:SOUR:FREQ:CHAN:BAND BAND38
Initial S/W Revision	A.11.50

BAND 39

Selects BAND 39 as the band for the current step.

Key Path	Source, Frequency, Radio Setup, Radio Standard, LTE TDD
Example	:SOUR:FREQ:CHAN:BAND BAND39
Initial S/W Revision	A.11.50

BAND 40

Selects BAND 40 as the band for the current step.

Key Path	Source, Frequency, Radio Setup, Radio Standard, LTE TDD
Example	:SOUR:FREQ:CHAN:BAND BAND40
Initial S/W Revision	A.11.50

BAND 41

Selects BAND 41 as the band for the current step.

Key Path	Source, Frequency, Radio Setup, Radio Standard, LTE TDD
Example	:SOUR:FREQ:CHAN:BAND BAND41
Initial S/W Revision	A.11.50

BAND 42

Selects BAND 42 as the band for the current step.

Key Path	Source, Frequency, Radio Setup, Radio Standard, LTE TDD
Example	:SOUR:FREQ:CHAN:BAND BAND42
Initial S/W Revision	A.11.50

BAND 43

Selects BAND 43 as the band for the current step.

Key Path	Source, Frequency, Radio Setup, Radio Standard, LTE TDD
Example	:SOUR:FREQ:CHAN:BAND BAND43
Initial S/W Revision	A.11.50

BAND 44

Selects BAND 44 as the band for the current step.

Key Path	Source, List Sequencer, List Sequencer Setup, Radio Setup, Radio Standard, LTE TDD
Initial S/W Revision	A.14.00

TDSCDMA

Sets TDSCDMA as the radio standard for use and accesses the TDSCDMA specific channel band sub-menus..

Key Path	Source, Frequency, Radio Setup, Radio Standard
Initial S/W Revision	A.11.50

BAND A

Selects BAND A as the band for the current step.

Key Path	Source, Frequency, Radio Setup, Radio Standard, TDSCDMA
Example	:SOUR:FREQ:CHAN:BAND BANDA
Initial S/W Revision	A.11.50

BAND B

Selects BAND B as the band for the current step.

Key Path	Source, Frequency, Radio Setup, Radio Standard, TDSCDMA
Example	:SOUR:FREQ:CHAN:BAND BANDB
Initial S/W Revision	A.11.50

BAND C

Selects BAND C as the band for the current step.

Key Path	Source, Frequency, Radio Setup, Radio Standard, TDSCDMA
Example	:SOUR:FREQ:CHAN:BAND BANDC
Initial S/W Revision	A.11.50

BAND D

Selects BAND D as the band for the current step.

Key Path	Source, Frequency, Radio Setup, Radio Standard, TDSCDMA
Example	:SOUR:FREQ:CHAN:BAND BANDD
Initial S/W Revision	A.11.50

BAND E

Selects BAND E as the band for the current step.

Key Path	Source, Frequency, Radio Setup, Radio Standard, TDSCDMA
Example	:SOUR:FREQ:CHAN:BAND BANDE
Initial S/W Revision	A.11.50

BAND F

Selects BAND F as the band for the current step.

Key Path	Source, Frequency, Radio Setup, Radio Standard, TDSCDMA
Example	:SOUR:FREQ:CHAN:BAND BANDF
Initial S/W Revision	A.11.50

Radio Band Link

Allows you to specify the radio band link direction for the steps within the list sequence. The link is used in conjunction with the channel band and channel number to determine the output frequency.

When set to “Uplink”, the source will calculate the uplink frequency according to an uplink formula together with selected channel band and channel number. When set to “Downlink”, the source will calculate the downlink frequency according to a downlink formula together with selected channel band and channel number.

Key Path	Source, List Sequencer, List Sequencer Setup, Radio Setup
Remote Command	:SOURce:LIST:STEP[1] 2 3...1000:SETup:RADio:BAND:LINK DOWN UP :SOURce:LIST:STEP[1] 2 3...1000:SETup:RADio:BAND:LINK?
Example	:SOUR:LIST:STEP2:SET:RAD:BAND:LINK UP :SOUR:LIST:STEP2:SET:RAD:BAND:LINK?
Notes	SCPI is supported after A.09.40
Preset	DOWN
Range	DOWN UP
Initial S/W Revision	A.05.00

Channel

Allows you to specify the frequency of the current step via a channel number.

Key Path	Source, List Sequencer, List Sequencer Setup
Remote Command	:SOURce:LIST:STEP[1] 2 3...1000:SETup:CNFRrequency <double> :SOURce:LIST:STEP[1] 2 3...1000:SETup:CNFRrequency?
Example	:SOUR:LIST:STEP2:SET:CNFR 124 :SOUR:LIST:STEP2:SET:CNFR?
Notes	SCPI is supported after A.09.40. This SCPI is used to setup channel number or frequency setting, according to current Radio Band setting. If Radio Band is "NONE", then it's frequency. If Radio Band is not "NONE", then it's channel number.
Couplings	The channel number is coupled to the step frequency value. When the step frequency value is changed, the channel number will increase or decrease to match the new step frequency. If the step frequency is not at an exact match for a channel number, the nearest channel number is displayed, along with a greater than, or less than sign to indicate the frequency is above or below the channel number.
Preset	1
Min	0 (Please refer to for valid ranges.)
Max	10838 (Please refer to for valid ranges.)
Initial S/W Revision	A.05.00

Frequency

Allows you to specify a frequency value for the current step.

Key Path	Source, List Sequencer, List Sequencer Setup
Remote Command	:SOURce:LIST:STEP[1] 2 3...1000:SETup:CNFRrequency <double> :SOURce:LIST:STEP[1] 2 3...1000:SETup:CNFRrequency?
Example	:SOUR:LIST:STEP2:SET:CNFR 1GHz :SOUR:LIST:STEP2:SET:CNFR?
Notes	SCPI is supported after A.09.40. This SCPI is used to setup channel number or frequency setting, according to current Radio Band setting. If Radio Band is "NONE", then it's frequency. If Radio Band is not "NONE", then it's channel number.
Couplings	The frequency value is coupled to the channel band and number for the step, such that updates to the radio band and channel number will update the frequency value to the corresponding absolute frequency. The reverse is also true, changing the frequency value causes the value of the channel number to be updated.
Preset	1.00 GHz
Min	10.00 MHz
Max	Hardware Dependant:

	Option 503 = 3.6 GHz Option 504 = 3.9 GHz Option 506 = 6.00 GHz
Initial S/W Revision	A.05.00

Power

Allows you to specify a power value for the current step.

Key Path	Source, List Sequencer, List Sequencer Setup
Remote Command	:SOURCE:LIST:STEP[1] 2 3...1000:SETup:AMPLitude <double> :SOURCE:LIST:STEP[1] 2 3...1000:SETup:AMPLitude?
Example	:SOUR:LIST:STEP2:SET:AMPL -50dBm :SOUR:LIST:STEP2:SET:AMPL?
Notes	SCPI is supported after A.09.40
Notes	Amplitude corrections can be specified for use with the source. In the event of amplitude corrections being applied, the valid ranges for the RF power do not change dependant on the current amplitude correction setting. Instead, if the combination of RF power + amplitude correction is higher or lower than the source output range, the Source Unleveled bit is set and the "Source Unleveled" indicator will appear on status panel to indicate that the source cannot maintain the output power that has been requested. The multiport adapter RFIO TX ports and GPS ports cannot ensure power accuracy when power setting is lower than -130dBm, this power setting value is defined by the sum of RF Power setting and related amplitude correction value. But user settable value could be lower than this limit. When application detected there exists power setting lower than -130dBm on MPA RFIO TX ports, then popup warning message . When application detected there exists power setting lower than -130dBm on MPA GPS ports, then popup warning message . These are only warning messages, and check is performed when RF is ON.
Notes	The Min and Max value here defined UI settable amplitude range. This range is larger than actual amplitude range with level accuracy defined in spec.
Dependencies	The RF power is dependent on the RF output port and frequency, such that the current frequency and selected output port determine the valid range of power values.
Preset	-100 dBm
Min	The range of values depends on the current frequency and selected RF output port. Please refer to "RF Power" on page 2098 and the table RF Power Range for the valid ranges.
Max	The range of values depends on the current frequency and selected RF output port. Please refer to "RF Power" on page 2098 and the table RF Power Range for the valid ranges.
Initial S/W Revision	A.05.00

Waveform

Allows you access to the sub-menus for selecting the waveform to be played back during the current step. Pressing this key also changes the central display area to show the Waveform File Selection view.

Key Path	Source, List Sequencer, List Sequencer Setup
Remote Command	:SOURce:LIST:STEP[1] 2 3...1000:SETup:WAVeform <string> :SOURce:LIST:STEP[1] 2 3...1000:SETup:WAVeform?
Example	:SOUR:LIST:STEP2:SET:WAV "CW" :SOUR:LIST:STEP2:SET:WAV?
Notes	SCPI is supported after A.09.40
Remote Command Notes	String type, takes "Off" "CW" "Cont" "waveform name"
Preset	CW
Range	Waveform Continue Previous CW Off
Initial S/W Revision	A.05.00

CW

Sets the current step to output a CW tone.

Key Path	Source, List Sequencer, List Sequencer Setup, Waveform
Example	:SOUR:LIST:STEP2:SET:WAV "CW"
Notes	SCPI is supported after A.09.40
Initial S/W Revision	A.05.00

Selected Waveform

Inserts the currently selected waveform in the waveform selection view as the waveform for playback during the current step.

Key Path	Source, List Sequencer, List Sequencer Setup, Waveform
Example	:SOUR:LIST:STEP2:SET:WAV "waveform name"
Notes	SCPI is supported after A.09.40 If the selected waveform contains header (which contains ARB play parameters), source list sequence will automatically apply header settings of the selected waveform in that step.
Initial S/W Revision	A.05.00

Continue Previous

Sets the current step to continue with playback of the waveform from the previous step. When continuing the previous waveform, the ARB playback will not pause while the source retunes to the new frequency or amplitude that may be defined for the new step.

Key Path	Source, List Sequencer, List Sequencer Setup, Waveform
----------	--

Example	:SOUR:LIST:STEP2:SET:WAV "Cont"
Notes	SCPI is supported after A.09.40
Initial S/W Revision	A.05.00

Off

Disable RF output of the current step.

Key Path	Source, List Sequencer, List Sequencer Setup, Waveform
Example	:SOUR:LIST:STEP2:SET:WAV "Off"
Notes	SCPI is supported after A.09.40
Initial S/W Revision	A.05.00

Segments on Hard Disk

Allows you access to the sub-menus for loading waveform segments from the hard disk into ARB memory. The default directory is: D: varb.

Pressing this key changes the current view to the Waveform Management View.

Key Path	Source, Modulation Setup, ARB, Select Waveform
Initial S/W Revision	A.05.00

Load Segment To ARB Memory

Allows you to load the selected file into ARB memory. On the front panel you select the file for loading to the ARB memory by highlighting the desired file in the list. Using the SCPI command, you specify the file name on the HDD.

"NVWFM" (none-volatile storage) MSUS (Mass Storage Unit Specifier) is supported in the memory subsystem because the ARB memory cannot be accessed directly. Therefore, files must be downloaded to the instrument hard disk and then loaded into the ARB memory. "NVWFM" MSUS will be mapped to the default directory D: VARB. The SCPI command supports using either "NVWFM" MSUS or specifying a full path. For more information, see Memory Subsystem (Remote Command Only).

If a file of the same name already exists within ARB memory, it is overwritten. If you wish to load two segments of the same name, you must rename one of the segments before loading it into ARB memory. To rename a segment, you can either use Windows File Explorer, or the :MMEMory:COPY command.

NOTE: When a waveform file is loaded to ARB memory, burst timing adjustments are made automatically, based on whether or not a Multiport Adapter is connected to the test set and powered on. If the connection/power status of the Multiport Adapter is changed after a waveform file has been loaded, it needs to be loaded again.

Key Path	Source, Modulation Setup, ARB, Select Waveform, Segments on Hard Disk
Remote Command	:SOURce:RADio:ARB:LOAD <string>
Example	:SOUR:RAD:ARB:LOAD "D: VARB\testwaveform.bin" or :SOUR:RAD:ARB:LOAD "NVWFM:testwaveform.bin"
Notes	<p>Because loading the file involves a delay of unpredictable length, this command should be followed by the query *OPC?, which holds off subsequent commands until the loading operating is complete.</p> <p><string> – specifies the path name of the file to load from the HDD into ARB memory. It could be a <full path + filename>, or <"NVWFM" MSUS + colon + filename>.</p> <p>When in Sequence Analyzer mode, and Include Source is Yes, an attempt to load a file to ARB memory will be rejected with an error.</p> <p>When Include Source is No and if there is insufficient free ARB memory to load the selected waveform, an error is generated. .</p> <p>If you specify a file over SCPI, but the file is not at the specified location, an error is generated.</p> <p>If you try to load a waveform file but the file contains less than 500 IQ samples, an error is generated.</p> <p>If you try to load a Signal Studio waveform "*.wfm" which contains invalid waveform header, an error is generated.</p> <p>If the ARB is ON when you load a file to ARB memory or delete a file from ARB memory, the playing waveform segment may not keep phase continuity during the ARB memory operation. The waveform will be replayed after the ARB operation is finished.</p> <p>ARB can be loaded into ARB memory even required licenses do not present on the instrument. In this case, a GUI only warning message -800, "Operation complete; Loaded <filename> successfully, but no license <required licenses> installed". User can install required licenses according to <required licenses> string to license it, or multi-pack license it.</p>
Initial S/W Revision	A.05.00

Load All To ARB Memory

Allows you to load all the segment files within the currently selected directory into ARB memory. If a file of the same name already exists within ARB memory, it is overwritten. If you wish to load two segments of the same name, you must rename one of the segments before loading it into ARB memory. To rename a segment, you can either use Windows File Explorer, or the :MEMory:COpy command.

NOTE: When a waveform file is loaded to ARB memory, burst timing adjustments are made automatically, based on whether or not a Multiport Adapter is connected to the test set and powered on. If the connection/power status of the Multiport Adapter is changed after a waveform file has been loaded, it needs to be loaded again.

Key Path	Source, Modulation Setup, ARB, Select Waveform, Segments on Hard Disk
Remote Command	:SOURce:RADio:ARB:LOAD:ALL <string>
Example	:SOUR:RAD:ARB:LOAD:ALL "D: varb"
Notes	<p><string> - specifies the directory on the HDD to load the files into ARB memory from.</p> <p>When in Sequence Analyzer mode, and Include Source is Yes, an attempt to load all files from a directory to ARB memory is rejected with an error.</p>

When Include Source is No and there is insufficient free ARB memory to load all the waveforms, when the ARB memory is full, the copy ceases, and an error is generated.

If you specify a directory over SCPI, but the directory does not exist, an error is generated.

If the ARB is ON, a user then loads or deletes file to ARB memory, the playing waveform segment may not keep phase continuity during the ARB memory operation. The waveform will be replayed after the ARB operation is finished.

Initial S/W Revision	A.05.00
----------------------	---------

Change Directory...

Allows you to change the currently selected directory on the hard disk. Pressing this key opens a standard windows change directory dialog allowing you to select the new directory of interest.

The current directory is used for manually loading waveform segments into ARB memory for playback, and as a search location for waveform segments that are required to be loaded into ARB memory for playback of a waveform sequence or a list sequence.

Key Path	Source, Modulation Setup, ARB, Select Waveform, Segments on Hard Disk
Notes	No remote command, SCPI front panel only.
Initial S/W Revision	A.05.00

Default Directory...

Allows you to change the default directory. It is used as a search location for waveform segments that are required to be loaded into ARB memory for playback of a waveform sequence, and as a search location for selecting waveforms using SCPI.

Key Path	Source, Modulation Setup, ARB, Select Waveform, Segments on Hard Disk
Remote Command	:SOURce:RADio:ARB:DEFault:DIRectory <string> :SOURce:RADio:ARB: DEFault:DIRectory?
Example	:SOUR:RAD:ARB:DEF:DIR "D:\ArbFiles" :SOUR:RAD:ARB:DEF:DIR?
State Saved	Persistent, survives a power cycle and a preset but not saved in the instrument state
Initial S/W Revision	A.05.00

Segments in ARB Memory

Allows you access to the sub-menus for managing the files within ARB memory.

Key Path	Source, Modulation Setup, ARB, Select Waveform
Initial S/W Revision	A.05.00

Delete Segment From ARB Mem

Allows you to remove a segment from ARB playback memory.

Key Path	Source, Modulation Setup, ARB, Select Waveform, Segments in ARB Memory
Remote Command	:SOURce:RADio:ARB:DELeTe <string>
Example	:SOUR:RAD:ARB:DEL "testwaveform.bin"
Notes	<p><string> - specifies the waveform to be deleted from the ARB playback memory.</p> <p>When in Sequence Analyzer mode and Include Source is Yes, an attempt to delete a file from ARB memory is rejected with an error.</p> <p>When Include Source is No and you specify a file that does not exist within ARB memory, an error is generated.</p> <p>It is possible to delete files from within the ARB memory when the ARB is ON. However, if you attempt to delete the file that is currently playing an error is generated.</p> <p>It is possible to delete a file from within the ARB memory when the sequencer state is ON and the file is not being used by the List Sequencer. If you attempt to delete a file which is being used by the list sequencer, an error is generated.</p> <p>When sequencer state is On, even if ARB state is On, the selected waveform will not be played. In this case, if the selected waveform is not used in List Sequence, it can be deleted and the ARB state is turned Off.</p> <p>If the ARB is ON and you load a file to ARB memory or delete a file from ARB memory, the playing waveform segment may not keep phase continuity during the ARB memory operation. The waveform will be replayed after the ARB operation is finished.</p>
Initial S/W Revision	A.05.00

Delete All From ARB Memory

Allows you to remove all segments from ARB playback memory.

Key Path	Source, Modulation Setup, ARB, Select Waveform, Segments in ARB Memory
Remote Command	:SOURce:RADio:ARB:DELeTe:ALL
Example	:SOUR:RAD:ARB:DELeTe:ALL
Notes	<p>When in Sequence Analyzer mode and Include Source is Yes, an attempt to delete all files from ARB memory is rejected with an error.</p> <p>When Include Source is No and you attempt to delete all files from ARB memory when the ARB is currently playing a file, all files except the one playing are deleted and an error is generated.</p> <p>If you attempt to delete all files from ARB memory when there are waveform files used in "List Sequencer" on page 2168 and "Sequencer" on page 2168 state is ON, all files except the files currently being used in list sequencer are deleted, and an error is generated.</p> <p>If the ARB is ON and you load a file to ARB memory or delete a file from ARB memory, the playing waveform segment may not keep phase continuity during the ARB memory operation. The waveform will be replayed after the ARB operation is finished.</p>
Initial S/W Revision	A.05.00

Step Duration

Allows access to the sub-menus for setting up the duration of play for the current step.

The duration can be set to be either the number of times for the ARB file associated with the sequence to play, or a specific time value, or continuous. If the step is set to play a CW tone, the step duration cannot be set to a play count.

Key Path	Source, List Sequencer, List Sequencer Setup
Remote Command	:SOURce:LIST:STEP[1] 2 3...1000:SETup:DURation:TYPE TIME COUNT CONTInuous CABort :SOURce:LIST:STEP[1] 2 3...1000:SETup:DURation:TYPE?
Example	:SOUR:LIST:STEP2:SET:DUR:TYPE TIME :SOUR:LIST:STEP2:SET:DUR:TYPE?
Notes	SCPI is supported after A.09.40
Notes	If “Step Duration” is set to “Time” or “Play Count” for the last step, the last step of ARB keeps playing as if set to “Continuous”, until the set “Time” has expired or until the “Play Count” setting is reached. However, you can query Error! Reference source not found. Source Sweeping Condition Message to find out if the current list sequence is complete or not.
Range	Time Play Count Continuous Continuous Abort
Initial S/W Revision	A.05.00

Time

Sets the duration of the current step to be a time value for the length of time the step will play. Pressing this key again opens another menu which allows you to set the time value for the step duration.

Key Path	Source, List Sequencer, List Sequencer Setup, Step Duration
Example	:SOUR:LIST:STEP2:SET:DUR:TYPE TIME
Notes	SCPI is supported after A.09.40
Initial S/W Revision	A.05.00

Duration Time

Allows you to specify the length of time the current step will play.

If the Transition Time value is longer than the Step Duration Time, an error is generated when initiating a source list sequence. For source list sequence, transition time is included in the step duration length (not occupy additional time). If the Transition Time value is longer than the Step Duration Time, the real step duration length is extended to equal the transition time and cause a timing shift. This check is also described in section **Error! Reference source not found.** List Sequence Step Validation.

Key Path	Source, List Sequencer, List Sequencer Setup, Step Duration, Time
Remote Command	:SOURce:LIST:STEP[1] 2 3...1000:SETup:DURation:TCOUNT <double> :SOURce:LIST:STEP[1] 2 3...1000:SETup:DURation:TCOUNT?

Example	:SOUR:LIST:STEP2:SET:DUR:TCO 1s :SOUR:LIST:STEP2:SET:DUR:TCO?
Notes	SCPI is supported after A.09.40 This SCPI is reused by "Play Count", "Duration Time" and "Continuous Abort" according to current Duration Type setting is "Play Count" or "Duration Time" or "Continuous Abort". If current "Duration Type" is "Continuous", then popup error -221, "Settings conflict;Cannot accept time or count input when step duration type is Continuous on step #"
Notes	If "Duration Time" is set for the last step, the last step of ARB keeps playing as if set to "Continuous" after set time expires. However, you can query Source Sweeping Condition Message (:STAT:OPER:COND?) to find out if the current list sequence is complete or not.
Preset	1.00 ms
Min	100 μs
Max	1800 s
Initial S/W Revision	A.05.00

Play Count

Sets the duration of the current step to be an integer value for the number of times (play count) the ARB file is selected for playback during this step. For example, a 5 second ARB will be set to play 5 times during the step.

Key Path	Source, List Sequencer, List Sequencer Setup, Step Duration
Example	:SOUR:LIST:STEP2:SET:DUR:TYPE COUN
Notes	SCPI is supported after A.09.40 This key is unavailable and is grayed out if the current step is configured to CW tone rather than an ARB waveform.
Initial S/W Revision	A.05.00

Header Utilities

Allows access to the header utilities sub-menu. Pressing this key also causes the central display area to change to display the File Header Information view.

Key Path	Source, Modulation Setup, ARB
Dependencies	This key is only available if there is currently a waveform selected for playback. If no waveform is selected, the key is grayed out.
Initial S/W Revision	A.05.00

Continuous

Sets the current step to be played continuously until the next step starts. The waveform will always play completely before transitioning to the next step.

Key Path	Source, List Sequencer, List Sequencer Setup, Step Duration
Example	:SOUR:LIST:STEP2:SET:DUR:TYPE CONT
Notes	SCPI is supported after A.09.40
Initial S/W Revision	A.05.00

Output Trigger

Allows you to specify the trigger output for the current step. The trigger output signal is sent at the start of the step.

When select “On”, trigger event will occur on both Internal and External2 paths. Select “Off” will turn off trigger output.

Key Path	Source, List Sequencer, List Sequencer Setup
Remote Command	:SOURce:LIST:STEP[1] 2 3...1000:SETup:OUTPut:TRIGger ON OFF 1 0 :SOURce:LIST:STEP[1] 2 3...1000:SETup:OUTPut:TRIGger
Example	:SOUR:LIST:STEP2:SET:OUTP:TRIG ON :SOUR:LIST:STEP2:SET:OUTP:TRIG?
Notes	SCPI is supported after A.09.40
Preset	Off
Range	On Off
Initial S/W Revision	A.05.00

Repetition

Allows access to the sub-menu for selecting the repetition type for the list sequencer globally. It cannot be changed between different sequence steps.

Key Path	Source, List Sequencer
Remote Command	:SOURce:LIST:REPetition:TYPE SINGLE CONTInuous
Example	:SOUR:LIST:REP:TYPE SING :SOUR:LIST:REP:TYPE?
Preset	SINGle
Range	SINGle CONTInuous
Initial S/W Revision	A.14.50

Single

Sets the repetition type as single for the whole source sequence. Source list will play one time after initiation.

Key Path	Source, List Sequencer, Repetition
Example	:SOUR:LIST:REP:TYPE SINGLE
Initial S/W Revision	A.14.50

Continuous

Sets the repetition type as continuous for the whole source sequence. Source list will play continuously after initiation.

Key Path	Source, List Sequencer, Repetition
Example	:SOUR:LIST:REP:TYPE CONTInuous
Initial S/W Revision	A.14.50

Trigger Type

Allows access to the sub-menu for selecting the output trigger type for the list sequencer globally. It cannot be changed between different sequence steps.

Key Path	Source, List Sequencer
Remote Command	:SOURce:LIST:TRIGgerout:TYPe BEGInningofstep DATamarker
Example	:SOUR:LIST:TRIG:TYP BEG :SOUR:LIST:TRIG:TYP?
Notes	SCPI is supported after A.14.00
Preset	BEGInningofstep
Range	BEGInningofstep DATamarker
Initial S/W Revision	A.14.00

BeginningOfStep

Sets the output trigger type as BeginningOfStep for the whole source sequence.

Key Path	Source, List Sequencer, Trigger Type
Example	:SOUR:LIST:TRIG:TYP BEG
Notes	SCPI is supported after A.14.00
Initial S/W Revision	A.14.00

DataMarker

Sets the output trigger type as DataMarker for the whole source sequence. When DataMarker is selected, which marker to route is also needed to be set.

Key Path	Source, List Sequencer, Trigger Type
Example	:SOUR:LIST:TRIG:TYP DAT
Notes	SCPI is supported after A.14.00
Initial S/W Revision	A.14.00

Marker 1

Sets the output trigger maker routing to Marker 1 for DataMarker in the whole source sequence.

Key Path	Source, List Sequencer, Trigger Type, DataMarker
Example	:SOUR:LIST:TRIG:TYPE:MARK M1
Notes	SCPI is supported after A.14.00
Initial S/W Revision	A.14.00

Marker 2

Sets the output trigger maker routing to Marker 2 for DataMarker in the whole source sequence.

Key Path	Source, List Sequencer, Trigger Type, DataMarker
Example	:SOUR:LIST:TRIG:TYPE:MARK M2
Notes	SCPI is supported after A.14.00
Initial S/W Revision	A.14.00

Marker 3

Sets the output trigger maker routing to Marker 3 for DataMarker in the whole source sequence.

Key Path	Source, List Sequencer, Trigger Type, DataMarker
Example	:SOUR:LIST:TRIG:TYPE:MARK M3
Notes	SCPI is supported after A.14.00
Initial S/W Revision	A.14.00

Marker 4

Sets the output trigger maker routing to Marker 4 for DataMarker in the whole source sequence.

Key Path	Source, List Sequencer, Trigger Type, DataMarker
Example	:SOUR:LIST:TRIG:TYPE:MARK M4
Notes	SCPI is supported after A.14.00
Initial S/W Revision	A.14.00

Manual Trigger Now

Pressing this key provides a software trigger event to the list sequencer. During execution of sequence, if the sequencer is halted on any step that has been configured with a “Manual” step trigger, then this key press will cause the sequencer to continue and execute the step.

Key Path	Source, List Sequencer
Remote Command	No remote command, front panel only.
Initial S/W Revision	A.05.00

Source Preset

Allows you to preset the source settings to their default values.

Key Path	Source
Remote Command	:SOURce:PRESet
Example	:SOUR:PRES

SPAN X Scale

Accesses a menu of functions that enable you to set the desired horizontal scale parameters.

Numbers and default numbers are independent for each window.

Metrics window and I/Q Symbol Polar Vector and Demod Bits window do not have this menu (Blank menu).

Key Path	Front-panel key
Initial S/W Revision	Prior to A.02.00

Start Code Number

Sets the start value of the code range for the code domain power graph (CDP) and CDE graph

Key Path	Span X Scale
Mode	CDMA2K
Remote Command	:DISPlay:CDPower:CDOMain:SPAN:STARt <integer> :DISPlay:CDPower:CDOMain:SPAN:STARt?
Example	DISP:CDP:CDOM:SPAN:STAR 5 DISP:CDP:CDOM:SPAN:STAR?
Couplings	Start Code Number and Stop Code Number are coupled to each other, according to: (A) Stop Code Number > Start Code Number and (B) Stop Code Number – Start Code Number >= 63 When changing the start code number, if it does not satisfy the above conditions, the stop code number is changed to satisfy (A) and (C). (C) Stop Code Number – Start Code Number = 63;
Preset	0
State Saved	Saved in instrument state.
Min	0
Max	64
Initial S/W Revision	Prior to A.02.00
Restriction and Notes	This button is only available when BTS is the selected mode and Base code length equal to 128.

Stop Code Number

Sets the stop value of the code range for the code domain power graph (CDP) and CDE graph.

Key Path	Span X Scale
----------	--------------

Remote Command	:DISPlay:CDPower:CDOMain:SPAN:STOP <integer> :DISPlay:CDPower:CDOMain:SPAN:STOP?
Example	DISP:CDP:CDOM:SPAN:STOP 127 DISP:CDP:CDOM:SPAN:STOP?
Notes	Default value is sensitive to the Base Code Length and Radio device. If Base Code Length is set 64, the stop code number is always 63, it can't be changed. If radio device is MS, it is always 31. when base code length equal to 64 or in MS mode, This key is grayed out.
Couplings	1.6.2.1.1 Start Code Number and 1.6.2.1.2 Stop Code Number are coupled to each other, according to: (A) Stop Code Number > Start Code Number and (B) Stop Code Number - Start Code Number >= 63 When changing the stop code number, if it does not satisfy the above, the start code number is changed to satisfy (A) and (C). (C) Stop Code Number - Start Code Number = 63;
Preset	63
State Saved	Saved in instrument state.
Min	63
Max	127
Initial S/W Revision	Prior to A.02.00

Code Span

Accesses a menu that enables you to set the start and stop values for the code range of the code domain power graph, if the display window is a Power Bar graph or CDE graph.

Key Path:	Span X Scale
------------------	--------------

Start Code Number

Sets the start value of the code range for the code domain power graph (CDP) and CDE graph

Key Path	Span X Scale
Mode	CDMA2K
Remote Command	:DISPlay:CDPower:CDOMain:SPAN:STARt <integer> :DISPlay:CDPower:CDOMain:SPAN:STARt?
Example	DISP:CDP:CDOM:SPAN:STAR 5 DISP:CDP:CDOM:SPAN:STAR?
Couplings	Start Code Number and Stop Code Number are coupled to each other, according to: (A) Stop Code Number > Start Code Number

	and (B) Stop Code Number – Start Code Number >= 63 When changing the start code number, if it does not satisfy the above conditions, the stop code number is changed to satisfy (A) and (C). (C) Stop Code Number – Start Code Number = 63;
Preset	0
State Saved	Saved in instrument state.
Min	0
Max	64
Initial S/W Revision	Prior to A.02.00
Restriction and Notes	This button is only available when BTS is the selected mode and Base code length equal to 128.

Stop Code Number

Sets the stop value of the code range for the code domain power graph (CDP) and CDE graph.

Key Path	Span X Scale
Remote Command	:DISPlay:CDPower:CDOMain:SPAN:STOP <integer> :DISPlay:CDPower:CDOMain:SPAN:STOP?
Example	DISP:CDP:CDOM:SPAN:STOP 127 DISP:CDP:CDOM:SPAN:STOP?
Notes	Default value is sensitive to the Base Code Length and Radio device. If Base Code Length is set 64, the stop code number is always 63, it can't be changed. If radio device is MS, it is always 31. when base code length equal to 64 or in MS mode, This key is grayed out.
Couplings	1.6.2.1.1 Start Code Number and 1.6.2.1.2 Stop Code Number are coupled to each other, according to: (A) Stop Code Number > Start Code Number and (B) Stop Code Number – Start Code Number >= 63 When changing the stop code number, if it does not satisfy the above, the start code number is changed to satisfy (A) and (C). (C) Stop Code Number – Start Code Number = 63;
Preset	63
State Saved	Saved in instrument state.
Min	63
Max	127
Initial S/W Revision	Prior to A.02.00

Sweep/Control

Accesses a menu that enables you to pause and restart the measurement. See Key and Command Descriptions – Sweep/Control for more information.

Key Path	Front Panel Key
Initial S/W Revision	Prior to A.02.00

Pause/Resume

Pauses a measurement after the current data acquisition is complete. When Paused, the label on the key changes to Resume. Pressing the Resume key resumes the measurement at the point it was at when paused. See Pause/Resume for details.

Key Path	Sweep/Control
Initial S/W Revision	Prior to A.02.00

System

See "System" on page 189

Trace/Detector

There is no Trace/Detector functionality supported in the Code Domain measurement. The front-panel key displays a blank menu key when pressed.

Key Path	Front-panel key
Initial S/W Revision	Prior to A.02.00

Trigger

See ["Trigger" on page 248](#)

Free Run

See ["Free Run " on page 255](#)

Video

See ["Video \(IF Envelope\) " on page 1440](#)

Trigger Level

See ["Trigger Level " on page 1440](#)

Trig Slope

See ["Trig Slope " on page 1441](#)

Trig Delay

See ["Trig Delay " on page 258](#)

External 1

See ["External 1 " on page 1454](#)

Trigger Level

See ["Trigger Level " on page 1455](#)

Trig Slope

See ["Trig Slope " on page 1455](#)

Trig Delay

See ["Trig Delay " on page 261](#)

Zero Span Delay Comp

See ["Zero Span Delay Comp On/Off " on page 1443](#)

External 2

See ["External 2 " on page 1456](#)

Trigger Level

See ["Trigger Level " on page 1457](#)

Trig Slope

See ["Trig Slope " on page 1457](#)

Trig Delay

See ["Trig Delay "](#) on page 264

Zero Span Delay Comp

See ["Zero Span Delay Comp On/Off"](#) on page 1446

RF Burst

See ["RF Burst "](#) on page 1458

Absolute Trigger

See ["Absolute Trigger Level"](#) on page 1458

Relative Trigger

See ["Relative Trigger Level"](#) on page 1448

Trig Slope

See ["Trigger Slope "](#) on page 1459

Trig Delay

See ["Trig Delay "](#) on page 268

Periodic Timer

See ["Periodic Timer \(Frame Trigger\) "](#) on page 1449

Period

See ["Period "](#) on page 1451

Offset

See ["Offset "](#) on page 1451

Offset Adjust (Remote Command Only)

See ["Offset Adjust \(Remote Command Only\)"](#) on page 1452

Reset Offset Display

See ["Reset Offset Display "](#) on page 1453

Sync Source

See ["Sync Source "](#) on page 1453

Off

See ["Off "](#) on page 1454

External 1

See "External 1 " on page 1454

Trigger Level

See "Trigger Level " on page 1455

Trig Slope

See "Trig Slope " on page 1455

External 2

See "External 2 " on page 1456

Trigger Level

See "Trigger Level " on page 1457

Trig Slope

See "Trig Slope " on page 1457

RF Burst

See "RF Burst " on page 1458

Absolute Trigger

See "Absolute Trigger Level" on page 1458

Trig Slope

See "Trigger Slope " on page 1459

Trig Delay

See "Trig Delay" on page 280

Auto/Holdoff

See "Auto/Holdoff " on page 1460

Auto Trig

See "Auto Trig " on page 1461

Trig Holdoff

See "Trig Holdoff " on page 1461

Internal

See "Internal" on page 282

User Preset

Accesses a menu that gives you the following three choices:

- User Preset – recalls a state previously saved using the Save User Preset function.
- User Preset All Modes – presets all of the modes in the analyzer
- Save User Preset– saves the current state for the current mode

NOTE

In products that run multiple instances of the X-Series Application, all instances use the same location to save User Preset state. So Save User Preset of one instance will overwrite the Save User Preset of another instance.

Key Path	Front-panel key
Backwards Compatibility Notes	<p>User Preset is actually loading a state, and in legacy analyzers, it was possible to load a state without affecting the trace data, limit lines or correction data. Similarly it was possible to do a User Preset without affecting the trace data, limit lines or correction data.</p> <p>In the X-Series, “state” always includes all of this data; so whenever state is loaded, or User Preset is executed, all of the traces, limit lines and corrections are affected. Although this differs from previous behavior, it is desirable behavior, and should not cause adverse issues for users.</p> <p>On ESA and PSA, User Preset affected the entire instrument’s state. In the X-Series, User Preset only recalls the state for the active mode. There is a User Preset file for each mode. User Preset can never cause a mode switch as it can in legacy analyzers. If you want to recall all modes to their user preset file state, you will need to do a User Preset after mode switching into each mode.</p> <p>User Preset recalls mode state which can now include data like traces; whereas on ESA and PSA, User Preset did not affect data.</p>
Initial S/W Revision	Prior to A.02.00

User Preset

User Preset sets the state of the currently active mode back to the state that was previously saved for this mode using the Save User Preset menu key or the SCPI command, SYST:PRES:USER:SAV. It not only recalls the Mode Preset settings, but it also recalls all of the mode persistent settings, and the Input/Output system setting that existed at the time Save User Preset was executed.

If a Save User Preset has not been done at any time, User Preset recalls the default user preset file for the currently active mode. The default user preset files are created if, at power-on, a mode detects there is no user preset file. There will never be a scenario when there is no user preset file to restore. For each mode, the default user preset state is the same state that would be saved if a Save User Preset is performed in each mode right after doing a Restore Mode Default and after a Restore Input/Output Defaults.

The User Preset function does the following:

- Aborts the currently running measurement.
- Sets the mode State to the values defined by Save User Preset.
- Makes the saved measurement for the currently running mode the active measurement.
- Brings up the saved menu for the power-on mode.

- Clears the input and output buffers.
- Sets the Status Byte to 0.

Key Path	User Preset
Remote Command	:SYSTem:PRESet:USER
Example	:SYST:PRES:USER:SAVE:SYST:PRES:USER
Notes	:SYST:PRES:USER:SAVE is used to save the current state as the user preset state. Clears all pending OPC bits. The Status Byte is set to 0. Pressing the User Preset front-panel key while already in the User Preset menu will cause the User Preset to get executed
Couplings	A user preset will cause the currently running measurement to be aborted and cause the saved measurement to be active. Recalling a User Preset file has the same issues that recalling a Save State file has. Some settings may need to be limited and therefore re-coupled, since the capabilities of the mode may have changes when the User Preset file was last saved.
Initial S/W Revision	Prior to A.02.00

User Preset All Modes

Recalls all of the User Preset files for each mode, switches to the power-on mode, and activates the saved measurement from the power-on mode User Preset file.

NOTE

When the instrument is secured, all of the user preset files are converted back to their default user preset files.

The User Preset function does the following:

- Aborts the currently running measurement.
- Switches the Mode to the power-on mode.
- Restores the User Preset files for each mode.
- Makes the saved measurement for the power-on mode the active measurement.
- Brings up the saved menu for the power-on mode.
- Clears the input and output buffers.
- Sets the Status Byte to 0.

Key Path	User Preset
Remote Command	:SYSTem:PRESet:USER:ALL
Example	:SYST:PRES:USER:SAVE:SYST:PRES:USER:ALL
Notes	Clears all pending OPC bits. The Status Byte is set to 0. :SYST:PRES:USER:SAVE is used to save the current state as the user preset state.
Couplings	A user preset will cause the currently running measurement to be aborted, cause a mode switch to the power-on mode, and cause the saved measurement to be active in the power-on mode.

Recalling a User Preset file has the same issues that recalling a Save State file has. Some settings may need to be limited and therefore re-coupled, since the capabilities of the mode may have changes when the User Preset file was last saved.

Initial S/W Revision Prior to A.02.00

Save User Preset

Saves the currently active mode and its State. You can recall this User Preset file by pressing the User Preset menu key or sending the SYST:PRES:USER remote command. This same state is also saved by the Save State function.

Key Path	User Preset
Remote Command	:SYSTem:PRESet:USER:SAVE
Example	:SYST:PRES:USER:SAVE
Notes	:SYST:PRES:SAVE creates the same file as if the user requested a *SAV or a MMEM:STOR:STAT, except User Preset Save does not allow the user to specify the filename or the location of the file.
Initial S/W Revision	Prior to A.02.00

View/Display

Accesses a menu of functions that enable you to control the instrument display.

The topic contains the following sections:

["View Selection by name \(SCPI only\)" on page 1713](#)

["View Selection by number \(SCPI only\)" on page 1713](#)

View Selection by name (SCPI only)

Selects the desired measurement view from the following selections:

- PGRaph(1) – Power Graph & Metrics provides a combination view of the code domain power graph and the summary data.
- CDE(2) – Power Graph & CDE Graph provides a combination view of the code domain power graph and the code domain error. Not available if the [:SENSE]:CDPower:CAPTURE:TIME(Capture Interval) is 4.0 or 8.0 or 16.0(Long Mode).
- SEVM(3) – I/Q Error (Quad View) – Symbol EVM provides a combination view of magnitude error, phase error, Symbol EVM, and the summary data.
- QUAD(4) – Code Domain (Quad View) provides a combination view for the code domain power symbol power, I/Q symbol polar vector and the summary data.
- DBITs(5) – Demod Bits provides a combination view of the graphs for the code domain power and symbol power, and the I/Q demodulated bit stream data for the symbol power slots selected by the measurement interval and measurement offset

Mode	CDMA2K
Remote Command	:DISPlay:CDPower:VIEW[:SElect] PGRaph CDE SEVM QUAD DBITs :DISPlay:CDPower:VIEW[:SElect]?
Example	DISP:CDP:VIEW PGR DISP:CDP:VIEW?
Remote Command Notes	You must be in the CDMA2000 mode to use this command. Use INSTRUMENT:SElect to set the mode.
Preset	PGRaph
State Saved	Saved in instrument state.
Range	Power Graph & Metrics CDP Graph & CDE Graph I/Q Error (Quad View) Code Domain (Quad View) Demod Bits Long Demod
Initial S/W Revision	Prior to A.02.00

View Selection by number (SCPI only)

Displays the numeric values of the measurement results. This function is available by SCPI command only

Remote Command	:DISPlay:CDPower:VIEW:NSElect <integer>
----------------	---

	:DISPlay:CDPower:VIEW:NSElect?
Example	DISP:CDP:VIEW:NSEL 2 DISP:CDP:VIEW:NSEL?
Remote Command Notes	You must be in the CDMA2000 mode to use this command. Use INSTRUMENT:SElect to set the mode.
Preset	1
State Saved	Saved in instrument state.
Min	1
Max	5
Initial S/W Revision	Prior to A.02.00

Key Path	Front panel key
Initial S/W Revision	Prior to A.02.00

Display

Accesses a menu of functions that enable you to set the display parameters.

See ["Display" on page 2212](#) for more information.

Key Path	View/Display
Initial S/W Revision	Prior to A.02.00

Annotation

Turns on and off various parts of the display annotation. The annotation is divided up into four categories:

1. Meas Bar: This is the measurement bar at the top of the screen. It does not include the settings panel or the Active Function. Turning off the Meas Bar turns off the settings panel and the Active Function. When the Meas Bar is off, the graticule area expands to fill the area formerly occupied by the Meas Bar.
2. Screen Annotation: this is the annotation and annunciation around the graticule, including any annotation on lines (such as the display line, the threshold line, etc.) This does NOT include the marker number or the N dB result. When off, the graticule expands to fill the entire graticule area.
3. Trace annotation: these are the labels on the traces, showing their detector (or their math mode).
4. Active Function annotation: this is the active function display in the meas bar, and all of the active function values displayed on softkeys.

See the figure below. Each type of annotation can be turned on and off individually.

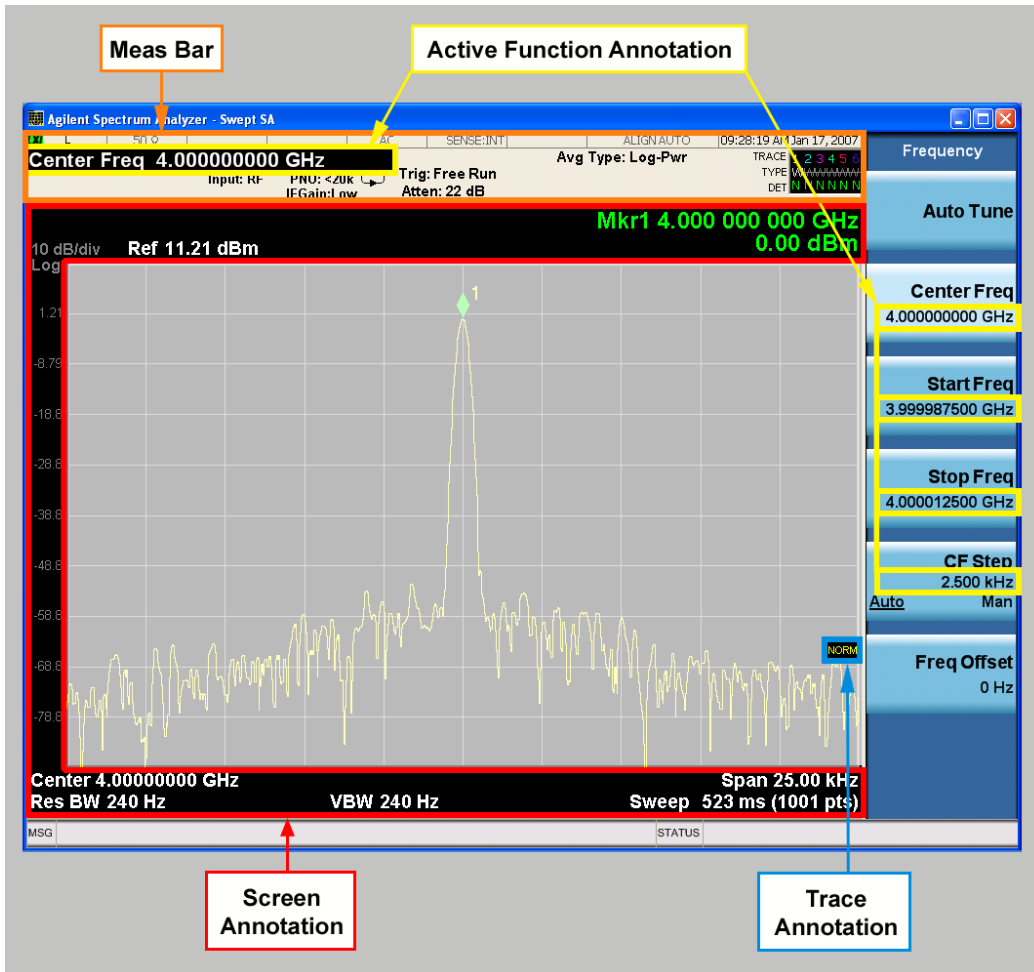

Key Path	View/Display, Display
Initial S/W Revision	Prior to A.02.00

Meas Bar On/Off

This function turns the Measurement Bar on and off, including the settings panel. When off, the graticule area expands to fill the area formerly occupied by the Measurement Bar.

Key Path	View/Display, Display, Annotation
Remote Command	:DISPlay:ANNotation:MBAR[:STATE] OFF ON 0 1 :DISPlay:ANNotation:MBAR[:STATE]?
Example	DISP:ANN:MBAR OFF
Dependencies	Grayed out and forced to OFF when System Display Settings, Annotation is set to Off.
Preset	On This should remain Off through a Preset when System DisplaySettings, Annotation is set to Off.

State Saved	Saved in instrument state.
Initial S/W Revision	Prior to A.02.00

Screen

This controls the display of the annunciation and annotation around the graticule, including any annotation on lines (such as the display line, the threshold line, etc.) and the y-axis annotation. This does NOT include marker annotation (or the N dB result). When off, the graticule expands to fill the entire graticule area, leaving only the 1.5% gap above the graticule as described in the Trace/Detector chapter.

Key Path	View/Display, Display, Annotation
Remote Command	:DISPlay:ANNotation:SCReen[:STATe] OFF ON 0 1 :DISPlay:ANNotation:SCReen[:STATe]?
Example	DISP:ANN:SCR OFF
Dependencies	Grayed-out and forced to OFF when System Display Settings, Annotation is set to Off.
Preset	On This should remain Off through a Preset when System DisplaySettings, Annotation is set to Off
State Saved	Saved in instrument state.
Initial S/W Revision	Prior to A.02.00

Active Function Values On/Off

Turns on and off the active function display in the Meas Bar, and all of the active function values displayed on the softkeys.

Note that all of the softkeys that have active functions have these numeric values blanked when this function is on. This is a security feature..

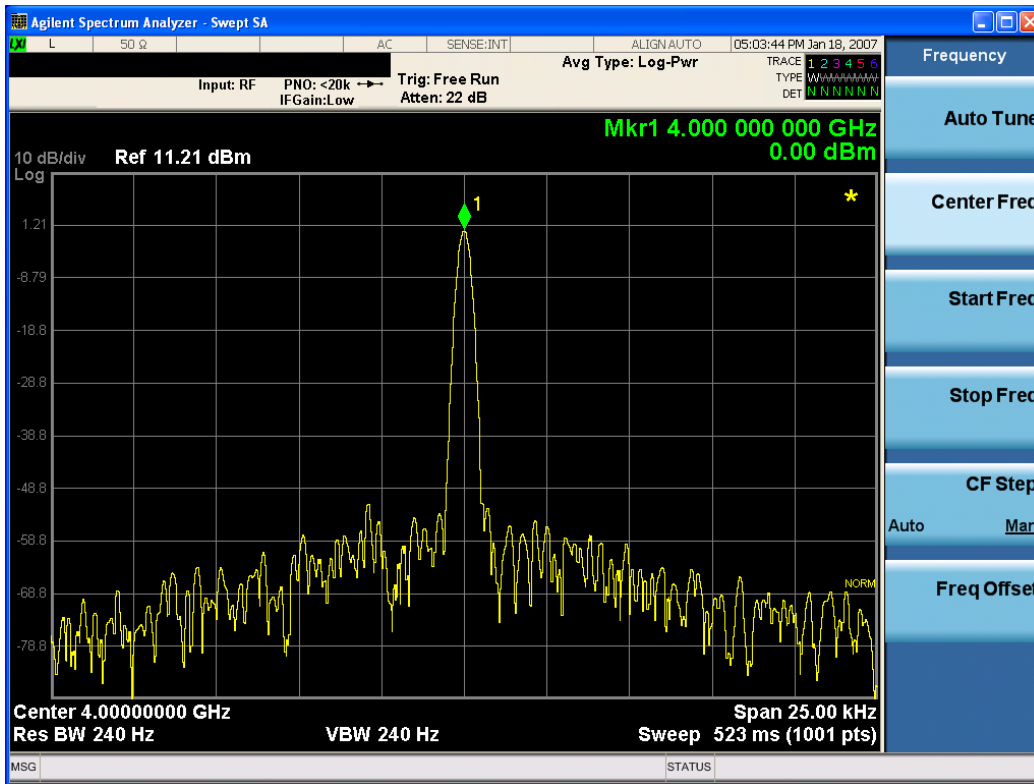

Key Path	View/Display, Display, Annotation
Remote Command	:DISPlay:ACTivefunc[:STATE] ON OFF 1 0 :DISPlay:ACTivefunc[:STATE]?
Example	DISP:ACT OFF
Dependencies	Grayed out and forced to OFF when System Display Settings, Annotation is set to Off.
Preset	On This should remain Off through a Preset when System DisplaySettings, Annotation is set to Off
State Saved	Saved in instrument state.
Initial S/W Revision	Prior to A.02.00

Title

Displays menu keys that enable you to change or clear a title on your display.

Key Path	View/Display, Display
Initial S/W Revision	Prior to A.02.00

Change Title

Writes a title into the "measurement name" field in the banner, for example, "Swept SA".

Press Change Title to enter a new title through the alpha editor. Press Enter or Return to complete the entry. Press ESC to cancel the entry and preserve your existing title.

The display title will replace the measurement name. It remains for this measurement until you press Change Title again, or you recall a state, or a Preset is performed. A title can also be cleared by pressing Title, Clear Title.

NOTE

Notice the inclusion of the <measurement> parameter in the command below. Because each measurement remembers the Display Title, the command must be qualified with the measurement name. For the Swept SA measurement this is not the case; no <measurement> parameter is used when changing the Display Title for the Swept SA measurement.

Key Path	View/Display, Display, Title
Mode	All
Remote Command	:DISPlay:<measurement>:ANNotation:TITLe:DATA <string> :DISPlay:<measurement>:ANNotation:TITLe:DATA?
Example	DISP:ANN:TITL:DATA "This Is My Title" This example is for the Swept SA measurement in the Spectrum Analyzer mode. The SANalyzer <measurement> name is not used. DISP:ACP:ANN:TITL:DATA "This Is My Title" This example is for Measurements other than Swept SA. Both set the title to: This Is My Title
Notes	Pressing this key cancels any active function. When a title is edited the previous title remains intact (it is not cleared) and the cursor goes at the end so that characters can be added or BKSP can be used to go back over previous characters.
Preset	No title (measurement name instead)
State Saved	Saved in instrument state.
Initial S/W Revision	Prior to A.02.00

Clear Title

Clears a title from the front-panel display. Once cleared, the title cannot be retrieved. After the title is cleared, the current Measurement Name replaces it in the title bar.

Key Path	View/Display, Display, Title
Example	The following commands clear the title and restore the measurement's original title: DISP:ANN:TITL:DATA "" This example is for the Swept SA measurement in the Spectrum Analyzer mode. The SANalyzer <measurement> name is not used. DISP:ACP:ANN:TITL:DATA "" This example is for ACP; in measurements other than Swept SA the measurement name is required.
Notes	Uses the :DISPlay:<measurement>:ANNotation:TITLe:DATA <string> command with an empty string (in the Swept SA, the <measurement> is omitted).

Preset	Performed on Preset.
Initial S/W Revision	Prior to A.02.00

Graticule

Pressing Graticule turns the display graticule On or Off. It also turns the graticule y-axis annotation on and off.

Key Path	View/Display, Display
Remote Command	:DISPlay:WINDow[1]:TRACe:GRATicule:GRID[:STATe] OFF ON 0 1 :DISPlay:WINDow[1]:TRACe:GRATicule:GRID[:STATe]?
Example	DISP:WIND:TRAC:GRAT:GRID OFF
Notes	The graticule is the set of horizontal and vertical lines that make up the grid/divisions for the x-axis and y-axis.
Preset	On
State Saved	Saved in instrument state
Initial S/W Revision	Prior to A.02.00

System Display Settings

These settings are "Mode Global" – they affect all modes and measurements and are reset only by Restore Misc Defaults or Restore System Defaults under System.

Key Path	View/Display, Display
Initial S/W Revision	Prior to A.02.00

Annotation Local Settings

This is a Mode Global override of the meas local annotation settings. When it is All Off, it forces ScreenAnnotation, Meas Bar, Trace, and Active Function Values settings to be OFF for all measurements in all modes. This provides the security based "annotation off" function of previous analyzers; hence it uses the legacy SCPI command.

When it is All Off, the Screen, Meas Bar, Trace, and Active Function Values keys under the Display, Annotation menu are grayed out and forced to Off. When Local Settings is selected, you are able to set the local annotation settings on a measurement by measurement basis.

Key Path	View/Display, Display, System Display Settings
Remote Command	:DISPlay:WINDow[1]:ANNotation[:ALL] OFF ON 0 1 :DISPlay:WINDow[1]:ANNotation[:ALL]?
Example	:DISP:WIND:ANN OFF

Preset	On (Set by Restore Misc Defaults)
State Saved	Not saved in instrument state.
Backwards Compatibility Notes	The WINDOW parameter and optional subopcode is included for backwards compatibility but ignored - all windows are equally affected.
Initial S/W Revision	Prior to A.02.00

Themes

Accesses a menu of functions that enable you to choose the theme to be used when saving the screen image.

The **Themes** option is the same as the **Themes** option under the **Display** and **Page Setup** dialogs. It allows you to choose between themes to be used when saving the screen image.

Key Path	Save, Screen Image
Remote Command	:MMEMory:STORe:SCReen:THEMe TDColor TDMonochrome FCOLor FMONochrome :MMEMory:STORe:SCReen:THEMe?
Example	:MMEM:STOR:SCR:THEM TDM
Preset	3D Color; Is not part of Preset, but is reset by Restore Misc Defaults or Restore System Defaults All and survives subsequent running of the modes.
Readback	3D Color 3D Mono Flat Color Flat Mono
Backwards Compatibility Notes	In ESA and PSA we offer the choice of "Reverse Bitmap" or "Reverse Metafile" when saving screen images. This is much like the "Flat Color" theme available in X-Series. Also, if you selected Reverse Bitmap AND a black & white screen image, that would be much like "Flat Monochrome". In other words, each of the X-Series themes has a similar screen image type in ESA/PSA. But they are not identical.
Initial S/W Revision	Prior to A.02.00

3D Color

Selects a standard color theme with each object filled, shaded and colored as designed.

Key Path	Save, Screen Image, Themes
Example	MMEM:STOR:SCR:THEM TDC
Readback	3D Color
Initial S/W Revision	Prior to A.02.00

3D Monochrome

Selects a format that is like 3D color but shades of gray are used instead of colors.

Key Path	Save, Screen Image, Themes
Example	MMEM:STOR:SCR:THEM TDM
Readback	3D Mono
Initial S/W Revision	Prior to A.02.00

Flat Color

Selects a format that is best when the screen is to be printed on an ink printer.

Key Path	Save, Screen Image, Themes
Example	MMEM:STOR:SCR:THEM FCOL
Readback	Flat Color
Initial S/W Revision	Prior to A.02.00

Flat Monochrome

Selects a format that is like Flat Color. But only black is used (no colors, not even gray), and no fill.

Key Path	Save, Screen Image, Themes
Example	MMEM:STOR:SCR:THEM FMON
Readback	Flat Mono
Initial S/W Revision	Prior to A.02.00

Power Graph & Metrics

Provides a combination view of the code domain power graph and the summary data.

"Radio Device: BTS" on page 1721

"Radio Device: MS" on page 1723

Radio Device: BTS

There are two windows: Power Bar Graph window (upper) and Metrics window (lower):

"CDP(Code Domain Power) Graph window" on page 1722

"Numeric Results window" on page 1722

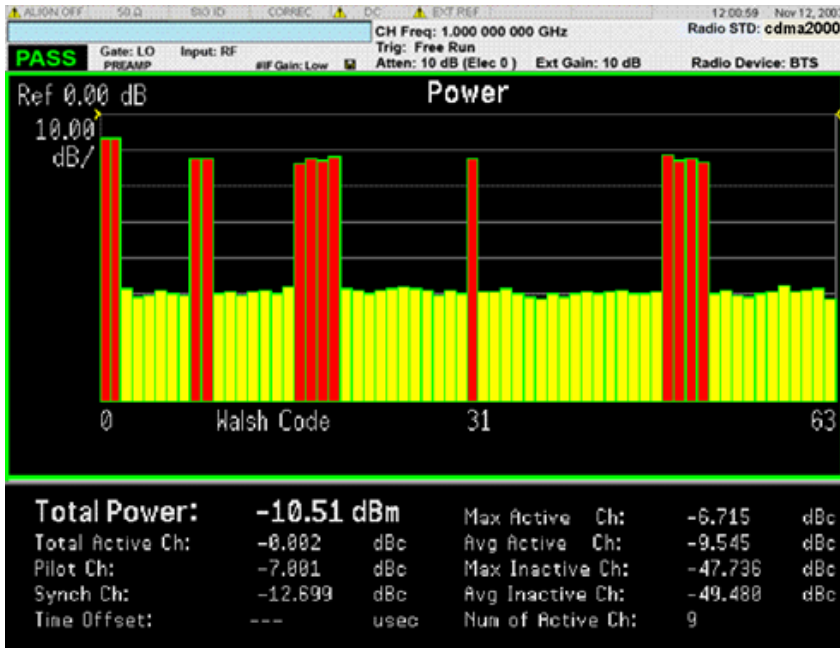

CDP(Code Domain Power) Graph window

Marker Operation	Yes
Corresponding Trace	CDPower (n=2)

Numeric Results window

Name	Corresponding	Description	Unit	Format
Total Power	n=1, 5th	the total RF power over the measurement interval.	dBm	nn.nn dBm
Total active channel power	n=1, 7th	the sum of the active channel power.	dBc or dBm (depending on the measurement type)	nn.nnn dBc/dBm
Pilot power	n=1, 8th	the average of the pilot code.	dBc or dBm (depending on the measurement type)	nn.nnn dBc/dBm
Sync power	n=1, 9th	power of the Sync code. In the MS mode, -999 shall be returned as a value.	dBc or dBm (depending on the measurement type)	nn.nnn dBc/dBm
Maximum active traffic power	n=1, 10th	maximum average power of the active code. If no active codes are detected, the value returned is -999. In the MS mode, -999 shall be returned as a value.	dBc or dBm (depending on the measurement type)	nn.nnn dBc/dBm

Average active traffic power	n=1, 11 th	the average power of all the active code. If no active codes are detected, the value returned is -999. In the MS mode, -999 shall be returned as a value.	dBc or dBm (depending on the measurement type)	nn.nnn dBc/dBm
Maximum inactive traffic power	n=1 12th	the maximum average power of the inactive traffic channels. In the MS mode, -999 shall be returned as a value.	dBc or dBm (depending on the measurement type)	nn.nnn dBc/dBm
Average inactive traffic power	n=1 13th	the average power of all the inactive traffic channels. In the MS mode, -999 shall be returned as a value.	dBc or dBm (depending on the measurement type)	nn.nnn dBc/dBm
Number of active channels	n=1, 14th	active codes. In the MS mode, -999 shall be returned as a value.	None	Integer format
Time between trigger to PN offset	n=1, 19th	The time from the trigger point to the PN offset. In the MS mode, the value return is -999.	us	nn.nnn us

Radio Device: MS

There are two windows: Power Bar Graph window (upper) and Metrics window (lower):

"CDP(Code Domain Power) Graph window" on page 1724

"Numeric Results window" on page 1724



CDP(Code Domain Power) Graph window

Marker Operation	Yes
Corresponding Trace	CDPower (n=2)

Numeric Results window

Name	Corresponding	Description	Unit	Format
Total Power	n=1, 5th	the total RF power over the measurement interval.	dBm	nn.nn dBm
Total active power	n=1, 7th	the sum of the active power.	dBc or dBm (depending on the measurement type)	nn.nnn dBc/dBm
Pilot power	n=1, 8th	the average of the pilot code.	dBc or dBm (depending on the measurement type)	nn.nnn dBc/dBm
I channel average active power	n=1, 15th	the average power of the active I channels. If no active codes are detected, the value returned is -999. In the BS mode, -999 shall be returned as a value.	dBc or dBm (depending on the measurement type)	nn.nnn dBc/dBm
I channel maximum inactive power	n=1, 16th	the maximum average power of the active I channels. In the BS mode, the value returned	dBc or dBm (depending on the measurement type)	nn.nnn dBc/dBm

		is -999.		
Q channel average active power	n=1, 17th	the average power of the active Q channels. If no active codes are detected, the value returned is -999. In the BS mode, -999 shall be returned as a value.	dBc or dBm (depending on the measurement type)	nn.nnn dBc/dBm
Q channel maximum inactive power	n=1, 18th	the maximum average power of the active Q channels. In the BS mode, the value returned is -999.	dBc or dBm (depending on the measurement type)	nn.nnn dBc/dBm

Key Path	View/Display
Initial S/W Revision	Prior to A.02.00

Code Order

Access the selection menu for the Walsh code order function. Set the Walsh code order function to Hadamard or Bit Reverse.

The Code Order key for Power Bar Graph and CDE Graph functions are coupled to each other.

Key Path	View/Display, Power Graph & Metrics
Mode	CDMA2K
Remote Command	:CALCulate:CDPower:WCODE:ORDER HADMrd BREVerse :CALCulate:CDPower:WCODE:ORDER?
Example	CALCulate:CDPower:WCODE:ORDER HADMrd CALCulate:CDPower:WCODE:ORDER?
Couplings	This command is effective only when the CDP window is selected.
Preset	HADMrd
State Saved	Saved in instrument state.
Range	Hadamard Bit Reverse
Initial S/W Revision	Prior to A.02.00

Base Code Length

Toggle the Walsh base code length between 64 and 128.

The Base Code Length for Power Bar Graph and CDE Graph functions are coupled to each other.

Key Path	View/Display, Power Graph & Metrics
----------	-------------------------------------

Mode	CDMA2K
Remote Command	:CALCulate:CDPower:WCode:BASE <integer> :CALCulate:CDPower:WCode:BASE?
Example	CALCulate:CDPower:WCode:BASE 64 CALCulate:CDPower:WCode:BASE?
Notes	Set the base code length (64 or 128) This key is grayed out when MS is selected as Radio device
Couplings	This command is effective only when the CDP window is selected.
Preset	64
State Saved	Saved in instrument state.
Range	64, 128
Min	64
Max	128
Initial S/W Revision	Prior to A.02.00

Consolidated Marker

Toggle the consolidated marker function between On and Off.

The Consolidated Marker for Power Bar Graph and CDE Graph functions are coupled to each other.

Key Path	View/Display, Power Graph & Metrics
Remote Command	DISPlay:CDPower:MARKer:CONSolidated ON OFF 1 0 DISPlay:CDPower:MARKer:CONSolidated?
Example	DISPlay:CDPower:MARKer:CONSolidated ON DISPlay:CDPower:MARKer:CONSolidated?
Notes	This key is displayed only when the CDP window is selected. This key shall be grayed out when the Code Order Bit Reverse key is selected. If set to On, the corresponding Walsh code channel power is marked in the different color upon placing the marker at the consolidated Walsh code channel power
Remote Command Notes	You must be in the CDMA2000 mode to use this command. Use INSTRument:SElect to set the mode.
Preset	ON
State Saved	Saved in instrument state.
Range	Off On
Initial S/W Revision	Prior to A.02.00

I/Q Error (Quad View)

Provides a combination view of magnitude error, phase error, Symbol EVM, and the summary data. There is no view settings for this view.

"Radio Device: BTS" on page 1727

"Radio Device: MS" on page 1728

Radio Device: BTS

There are four windows:

"Magnitude Error window" on page 1727

"Phase Error window" on page 1728

"EVM window" on page 1728

"Numeric Results window" on page 1728

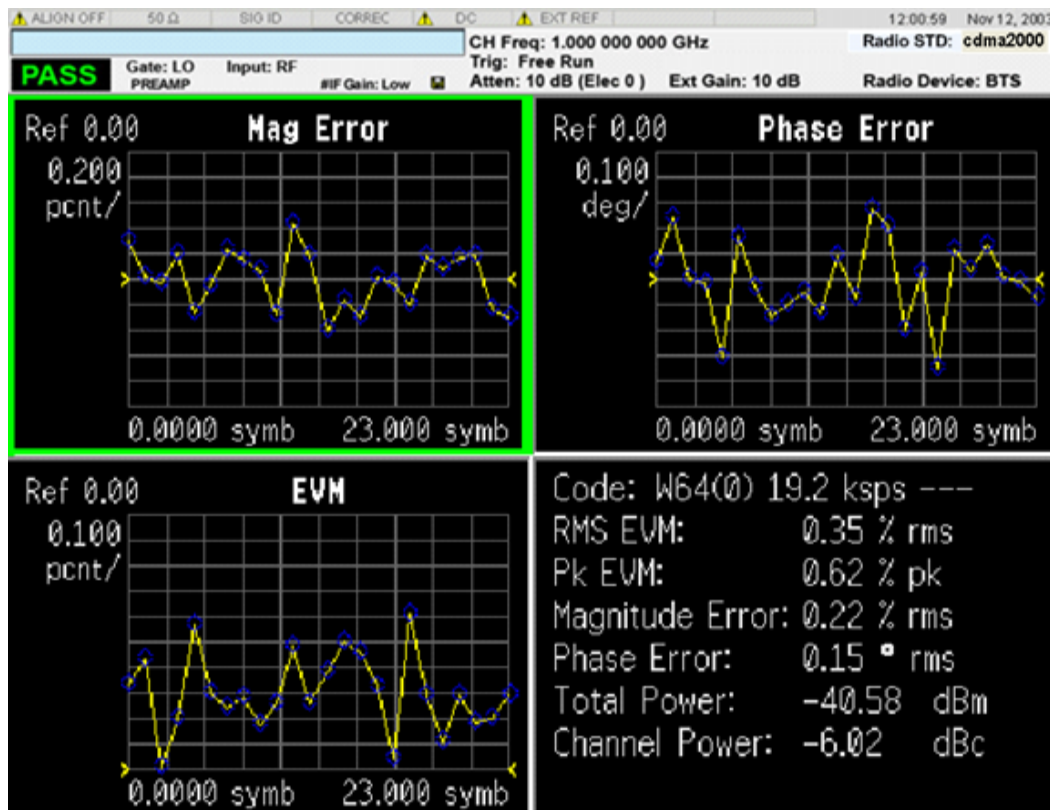

Magnitude Error window

Marker Operation	Yes
Corresponding Trace	MERRor (n=6)

Phase Error window

Marker Operation	Yes
Corresponding Trace	PERRor (n=7)

EVM window

Marker Operation	Yes
Corresponding Trace	EVM (n=5)

Numeric Results window

Name	Corresponding	Description	Unit	Format
Code Number	NA	NA		WX(Y) N ksp X: Walsh code level (2 ,4,8,... 128) Y: Walsh code number (0 ... X) N: 9.6, 14.4, 153.6 ..., 230.4 ksp
RMS EVM	n=1 1st	RMS symbol EVM	%	nn.nn % rms
Pk EVM	n=1 2nd	Peak symbol EVM	%	nn.nn % pk
Magnitude Error	n=1 3rd	Symbol magnitude error	%	nn.nn % rms
Phase Error	n=1 4th	Symbol phase error	degree	nn.nn °rms
Total Power	n=1 5th	total RF power over measurement interval.	dBm	-nn.nn dBm
Channel Power	n=1 6th	Channel Power	dBc or dBm (depending on the measurement type)	-nn.nn dBc/dBm

Radio Device: MS

"Magnitude Error window Note 1" on page 1729

"Phase Error window (Note 1, 2)" on page 1729

"EVM window Note 1" on page 1729

"Numeric Results window" on page 1729

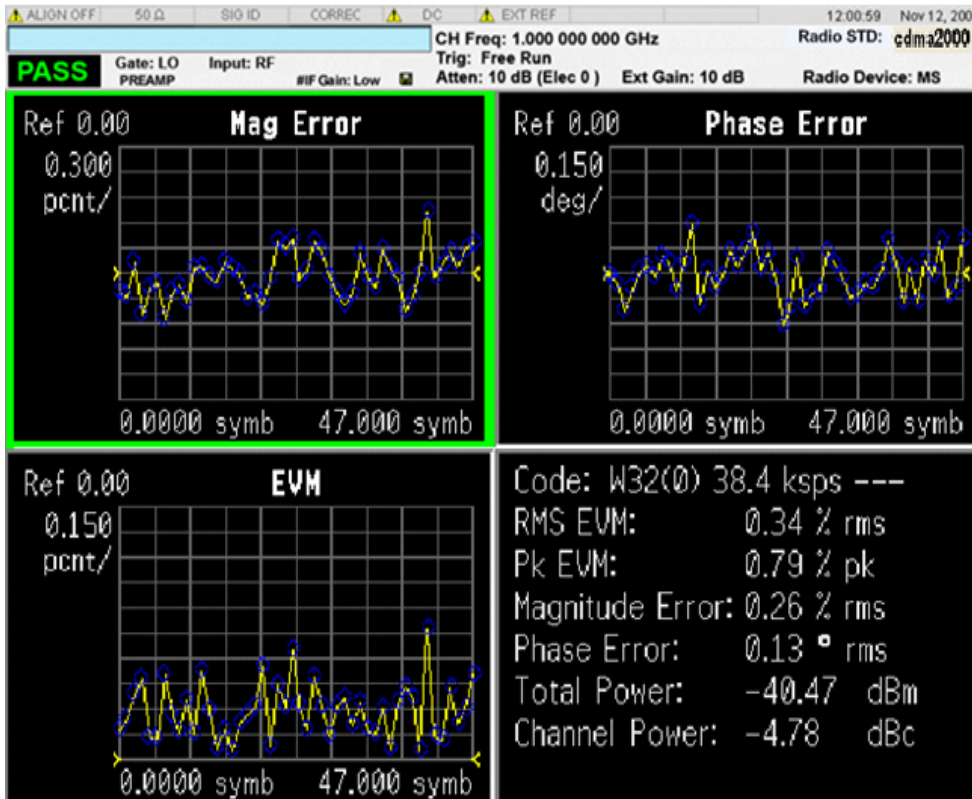

Magnitude Error window ^{Note 1}

Marker Operation	Yes
Corresponding Trace	MERRor (n=6)

Phase Error window (Note 1, 2)

Marker Operation	Yes
Corresponding Trace	PERRor(n=7)

EVM window ^{Note 1}

Marker Operation	Yes
Corresponding Trace	EVM (n=5)

Numeric Results window

Name	Corresponding	Description	Unit	Format
------	---------------	-------------	------	--------

Code Number	NA	NA		WX(Y) N ksp X: Walsh code level (2, 4, 8, ... 128) Y: Walsh code number (0 ... X) N: 9.6, 14.4, 153.6 ..., 230.4 ksp
RMS EVM	n=1 1st	RMS symbol EVM (Note 1)	%	nn.nn % rms
Pk EVM	n=1 2nd	Peak symbol EVM (Note 1)	%	nn.nn % pk
Magnitude Error	n=1 3rd	Symbol magnitude error (Note 1)	%	nn.nn % rms
Phase Error	n=1 4th	Symbol phase error (Note 2)	degree	nn.nn °rms
Total Power	n=1 5th	Total RF power over measurement interval.	dBm	-nn.nn dBm
Channel Power	n=1 6th	Channel Power	dBc or dBm (depending on the measurement type)	-nn.nn dBc/dBm

Note 1:

When I/Q Branch is either I (-BPSK) or Q (-BPSK):

EVM of single code Channel is calculated independently between I and Q each other.

When I/Q Branch is IQC (-Combined)

EVM is calculated based on combined symbol vector of I and Q decision point.

Note 2:

When I/Q Branch is either I (-BPSK) or Q (-BPSK)

IQ Phase error is no meaning.

When I/Q Branch is IQ (-Combined):

IQ Phase error is calculated based on combined symbol vector of I and Q decision point.

Key Path	View/Display
Initial S/W Revision	Prior to A.02.00

13 Modulation Accuracy (Composite Rho) Measurement

Rho is one of the key modulation quality metrics, along with EVM. Rho is the ratio of the correlated power in a multi coded channel to the total signal power. This measurement takes into account all possible error mechanisms in the entire transmission chain including: baseband filtering, I/Q modulation anomalies, filter amplitude and phase non-linearity, and power amplifier distortions.

This provides an overall indication of the performance level of the transmitter of the unit under test (UUT).

For measurements results and views, see ["View/Display" on page 1962](#).

This section contains the following topics:

["Measurement Commands for Modulation Accuracy" on page 1732](#)

["Remote Command Results for Modulation Accuracy Measurement" on page 1733](#)

Measurement Commands for Modulation Accuracy

You must be in the cdma2000 to use these commands. Use INSTRUMENT:SElect to set the mode.

:CONFigure:RHO

:FETCh:RHO [n] ?

:READ:RHO [n] ?

:MEASure:RHO [n] ?

For more measurement related commands, see the SENSE subsystem, and the section "[Remote Measurement Functions](#)" on page 2015.

Remote Command Results for Modulation Accuracy Measurement

n	Results Returned
0	Returns unprocessed I/Q trace data, as a series of comma-separated trace points, in volts. The I values are listed first in each pair, using the 0 through even-indexed values. The Q values are the odd-indexed values.
not specified or n = 1	Returns the following 11 scalar results: <ol style="list-style-type: none"> 1. RMS EVM (Average) is a floating point number (in percent) of EVM over the entire measurement area 2. Peak EVM (Peak Hold) is a floating point number (in percent) of the peak EVM in the measurement area 3. Magnitude error (Average) is a floating point number (in percent) of the average magnitude error over the entire measurement area 4. Phase error (Average) is a floating point number (in degree) of the average phase error over the entire measurement area 5. I/Q origin offset (Average) is a floating point number (in dB) of the I and Q error (magnitude squared) offset from the origin 6. Frequency error (Average) is a floating point number (in Hz) of the frequency error in the measured signal 7. Rho (Average) is a floating point number of Rho 8. Peak Code Domain Error (Peak Hold) is a floating point number (in dB) of the Peak Code Domain Error relative to the mean reference power 9. Peak Code Domain Error Channel Number (Peak Hold) is the channel number in which the peak code domain error is detected. 10. Number of active channels. 11. Time offset (Average) is a floating point number (in chips) of the pilot phase timing from the acquisition trigger point.
2	EVM trace – returns series of floating point numbers (in percent) that represent each sample in the EVM trace. The first number is the symbol 0 decision point. There are X points per symbol (X=points/chip). Therefore, the decision points are at 0, 1*X, 2*X, ...
3	Magnitude error trace – returns series of floating point numbers (in percent) that represent each sample in the magnitude error trace. The first number is the symbol 0 decision point. There are X points per symbol (X=points/chip). Therefore, the decision points are at 0, 1*X, 2*X, ...
4	Phase error trace – returns series of floating point numbers (in percent) that represent each sample in the phase error trace. The first number is the symbol 0 decision point. There are X points per symbol (X=points/chip). Therefore, the decision points are at 0, 1*X, 2*X, ...
5	Corrected measured trace – returns series of floating point numbers that alternately represent I and Q pairs of the corrected measured trace. The magnitude of each I and Q pair are normalized to 1.0. The first number is the I sample of symbol 0 decision point and the second number is the Q sample of symbol 0 decision point. There are X points per symbol (X=points/chip). Therefore, the series of numbers is: <ol style="list-style-type: none"> 1st number = I of the symbol 0 decision point 2nd number = Q of the symbol 0 decision point ...

	(2*X)+1 number = I of the symbol 1 decision point
	(2*X)+2 number = Q of the symbol 1 decision point
	...
	(2*X)*N+1 th number = I of the symbol N decision point
	(2*X)*N+2 th number = Q of the symbol N decision point

6	Returns 6 scalar values of the pass/fail (0=passed, or 1=failed) results determined by testing the EVM, the peak EVM, Rho, the peak code domain error, the time offset, and the phase error.
7	Returns series of floating point numbers of code level, code index, power (in dB), time offset (in ns), phase offset (in rad), and code domain error (in dB). The total number of results are six times of "number of active channels". The number of active channels can be obtained by the 10th result of READ:RHO1 command.

Key Path	Meas
Initial S/W Revision	Prior to A.02.00

AMPTD Y Scale

Accesses the AMPTD Y Scale menu that allows you to set the desired vertical scale and associated settings. The menus under this menu are available when in “I/Q Error” view. And only Attenuation is available when in the following views:

“I/Q Measured Polar Graph”

“Power, Timing, and Phase”.

Key Path	Front-panel key
Initial S/W Revision	Prior to A.02.00

Ref Value

Sets the absolute power reference value ranging from –500.00 to 500.00 dBm with 0.01 dB resolution. However, since Auto Scaling defaults to On, this value is automatically determined by the measurement result. When you set a value manually, Auto Scaling automatically changes to Off.

Key Path	AMPTD Y Scale
Initial S/W Revision	Prior to A.02.00

I/Q Error View - EVM Window

Sets the absolute power reference value in the EVM window.

Key Path	AMPTD Y Scale
Mode	CDMA2K
Remote Command	:DISPlay:RHO:VIEW2:WINDow[1]:TRACe:Y[:SCALe]:RLEVel <real> :DISPlay:RHO:VIEW2:WINDow[1]:TRACe:Y[:SCALe]:RLEVel?
Example	DISP:RHO:VIEW2:WIND:TRAC:Y:RLEV 0.0 DISP:RHO:VIEW2:WIND:TRAC:Y:RLEV?
Notes	If Auto Scaling is set to On, this value is automatically determined by the measurement result. When you set this value manually, Auto Scaling is automatically set to Off.
Remote Command Notes	WINDow[1]: Evm window on I/Q Error view
Couplings	See Restriction and Notes
Preset	0.00
State Saved	Saved in instrument state.
Min	–500.0
Max	500.0
Initial S/W Revision	Prior to A.02.00

I/Q Error View – Mag Error Window

Sets the absolute power reference value in the magnitude error window.

Key Path	AMPTD Y Scale
Mode	CDMA2K
Remote Command	:DISPlay:RHO:VIEW2:WINDow2:TRACe:Y[:SCALe]:RLEVel <real> :DISPlay:RHO:VIEW2:WINDow2:TRACe:Y[:SCALe]:RLEVel?
Example	DISP:RHO:VIEW2:WIND2:TRAC:Y:RLEV 0.0 DISP:RHO:VIEW2:WIND2:TRAC:Y:RLEV?
Notes	If Auto Scaling is set to On, this value is automatically determined by the measurement result. When you set this value manually, Auto Scaling is automatically set to Off.
Remote Command Notes	WINDow2: Mag Error window on I/Q Error view
Couplings	See Restriction and Notes
Preset	0.00
State Saved	Saved in instrument state.
Min	-500.0
Max	500.0
Initial S/W Revision	Prior to A.02.00

I/Q Error View – Phase Error Window

Sets the absolute power reference value in the phase error window.

Key Path	AMPTD Y Scale
Mode	CDMA2K
Remote Command	:DISPlay:RHO:VIEW2:WINDow3:TRACe:Y[:SCALe]:RLEVel <real> :DISPlay:RHO:VIEW2:WINDow3:TRACe:Y[:SCALe]:RLEVel?
Example	DISP:RHO:VIEW2:WIND3:TRAC:Y:RLEV 0.0 DISP:RHO:VIEW2:WIND3:TRAC:Y:RLEV?
Notes	If Auto Scaling is set to On, this value is automatically determined by the measurement result. When you set this value manually, Auto Scaling is automatically set to Off.
Remote Command Notes	WINDow3: Phase Error window on I/Q Error view
Couplings	See Restriction and Notes
Preset	0.00
State Saved	Saved in instrument state.
Min	-36000.0
Max	36000.0
Initial S/W Revision	Prior to A.02.00

Range

The Range menu allows setting amplitude controls of the instrument.

Key Path	AMPTD Y Scale
Scope	Meas Global
Initial S/W Revision	A.12.50

Range

Represents the amplitude of the largest sinusoidal signal that could be present within the IF without being clipped by the ADC. For signals with high peak-to-average ratios, the range may need to exceed the rms signal power by a fair amount to avoid clipping.

Key Path	Range
Mode	BASIC
Remote Command	[:SENSe] :POWer [:RF] :RANGe <real> [:SENSe] :POWer [:RF] :RANGe?
Example	:POW:RANG 10.0 :POW:RANG?
Notes	The MIN and MAX values are affected by the External Gain parameters, and by the Center Frequency. (The hardware compensates for frequency response and alters the Range setting.)
Preset	0
State Saved	Saved in instrument state.
Min	-100
Max	100
Initial S/W Revision	A.12.50

Adjust Range For Min Clip

Sets the combination of attenuation and gain based on the current measured signal level so that clipping will be at a minimum.

This is an "immediate action" function, that is, it executes once, when the key is pressed.

This key is grayed out in measurements that do not support this functionality.

Key Path	AMPTD Y Scale, Attenuation
Remote Command	[:SENSe] :POWer [:RF] :RANGe:OPTimize IMMEDIATE
Initial S/W Revision	Prior to A.02.00
Modified at S/W Revision	A.03.00

Pre-Adjust for Min Clip

If this function is on, it does the adjustment described under Adjust Range For Min Clip each time a measurement restarts. Therefore, in Continuous measurement mode, it only executes before the first measurement.

Key Path	AMPTD Y Scale, Attenuation
Remote Command	<code>[:SENSe] :POWer [:RF] :RANGe:OPTimize:ATTenuation OFF ON ELECTrical COMBined</code> <code>[:SENSe] :POWer [:RF] :RANGe:OPTimize:ATTenuation?</code>
Notes	This parameter is shared with old XA platform which uses AutoAtten. To keep the backward compatibility, ELECTrical and COMBined still can be used. Then, upon receiving ELECTrical and COMBined, these enums will be interpreted as aliases of ON. Then, when queried, ON will be returned.
Preset	OFF for Swept SA measurement; ON for all other measurements that support Pre-Adjust for Min Clip
State Saved	Saved in instrument state
Initial S/W Revision	Prior to A.02.00
Modified at S/W Revision	A.03.00

Peak to Average

The Peak to Average Ratio is used with the Range setting to optimize the level control in the instrument. The value is the ratio, in dB, of the peak power to the average power of the signal to be measured. A ratio of 0 should be used for sinusoidal signals; for 802.11g OFDM signals use 9 dB.

All Applications (Modes) will show the current value of Peak to Average ratio on the softkey. However, some applications will not permit changing the value. In these situations the softkey will be grayed-out.

Key Path	AMPTD Y Scale, Range
Remote Command	<code>[:SENSe] :POWer [:RF] :RANGe:PARatio <real></code> <code>[:SENSe] :POWer [:RF] :RANGe:PARatio?</code>
Example	POW:RANG:PAR 12 dB
Notes	In some Applications (Modes) this parameter will be read-only; meaning the value will appear on the softkey and query via SCPI, but not changeable. In such applications the softkey will be grayed-out. Attempting to change the value via SCPI will be ignored and no error message will be generated.
Preset	10 dB
State Saved	Saved in instrument state
Min	0 dB
Max	20 dB
Initial S/W Revision	A.13.00

Mixer Level Offset

Mixer level offset is an advanced setting to adjust target Range at the input mixer which in turn affects the signal level in the instrument's IF. This setting can be used when additional optimization is needed after setting Peak to Average ratio. Positive values of offset optimize noise performance over distortion, negative values optimize distortion performance over noise.

Key Path	AMPTD Y Scale, Range
Remote Command	[:SENSe]:POWer[:RF]:RANGe:MIXer:OFFSet <real> [:SENSe]:POWer[:RF]:RANGe:MIXer:OFFSet?
Example	POW:RANG:MIX:OFFS -5 dB
Preset	0 dB
State Saved	Saved in instrument state
Min	-35 dB
Max	30 dB
Initial S/W Revision	A.13.00

Ref Position

Positions the Y-axis scale reference level at the top, center or bottom of the display. Changing the reference position does not change the reference level value.

Key Path	AMPTD Y Scale
Initial S/W Revision	Prior to A.02.00

I/Q Error View - EVM Window

Sets the reference position of the vertical axis in the EVM window.

Key Path	AMPTD Y Scale
Mode	CDMA2K
Remote Command	:DISPlay:RHO:VIEW2:WINDow[1]:TRACe:Y[:SCALe]:RPOSition TOP CENTer BOTTom :DISPlay:RHO:VIEW2:WINDow[1]:TRACe:Y[:SCALe]:RPOSition?
Example	DISP:RHO:VIEW2:WIND:TRAC:Y:RPOS TOP DISP:RHO:VIEW2:WIND:TRAC:Y:RPOS?
Preset	BOTTom
State Saved	Saved in instrument state.
Range	Top Ctr Bot
Initial S/W Revision	Prior to A.02.00

I/Q Error View – Mag Error Window

Sets the reference position of the vertical axis in the magnitude error window.

Key Path	AMPTD Y Scale
Mode	CDMA2K
Remote Command	:DISPlay:RHO:VIEW2:WINDow2:TRACe:Y[:SCALe]:RPOSition TOP CENTer BOTTom :DISPlay:RHO:VIEW2:WINDow2:TRACe:Y[:SCALe]:RPOSition?
Example	DISP:RHO:VIEW2:WIND2:TRAC:Y:RPOS TOP DISP:RHO:VIEW2:WIND2:TRAC:Y:RPOS?
Preset	CENTER
State Saved	Saved in instrument state.
Range	Top Ctr Bot
Initial S/W Revision	Prior to A.02.00

I/Q Error View – Phase Error Window

Sets the reference position of the vertical axis in the phase error window.

Key Path	AMPTD Y Scale
Mode	CDMA2K
Remote Command	:DISPlay:RHO:VIEW2:WINDow3:TRACe:Y[:SCALe]:RPOSition TOP CENTer BOTTom :DISPlay:RHO:VIEW2:WINDow3:TRACe:Y[:SCALe]:RPOSition?
Example	DISP:RHO:VIEW2:WIND3:TRAC:Y:RPOS TOP DISP:RHO:VIEW2:WIND3:TRAC:Y:RPOS?
Preset	CENTER
State Saved	Saved in instrument state.
Range	Top Ctr Bot
Initial S/W Revision	Prior to A.02.00

Auto Scaling

Toggles the Auto Scaling function between On and Off. When Auto Scaling is On, pressing the Restart front-panel key results in automatically determining scale per division and reference values based on the measurement results.

When you set a value to either Scale/Div or Ref Value manually, Auto Scaling automatically changes to Off.

Key Path	AMPTD Y Scale
Initial S/W Revision	Prior to A.02.00

I/Q Error View – EVM Window

When Auto Scaling is On, pressing the Restart front-panel key results in automatically displaying the scale per division and reference value results for the vertical axis in the EVM window.

Key Path	AMPTD Y Scale
Mode	CDMA2K
Remote Command	:DISPlay:RHO:VIEW2:WINDow[1]:TRACe:Y[:SCALE]:COUPle 0 1 OFF ON :DISPlay:RHO:VIEW2:WINDow[1]:TRACe:Y[:SCALE]:COUPle?
Example	DISP:RHO:VIEW2:WIND:TRAC:Y:COUP ON DISP:RHO:VIEW2:WIND:TRAC:Y:COUP?
Notes	When this parameter is set to On, pressing the front-panel Restart key, or the Restart key in the Meas Control menu, activates the scale coupling function, that automatically determines scale per division and reference values based on the measurement results. When you set a value to either Scale/Div or Ref Value manually, Auto Scaling is automatically set to Off.
Remote Command Notes	WINDow[1]: EVM window on I/Q Error view
Couplings	See Restriction and Notes
Preset	ON
State Saved	Saved in instrument state.
Range	On Off
Initial S/W Revision	Prior to A.02.00

I/Q Error View – Mag Error Window

When Auto Scaling is On, pressing the Restart front-panel key results in automatically displaying the scale per division and reference value results for the vertical axis in the magnitude error window.

Key Path	AMPTD Y Scale
Mode	CDMA2K
Remote Command	:DISPlay:RHO:VIEW2:WINDow2:TRACe:Y[:SCALE]:COUPle 0 1 OFF ON :DISPlay:RHO:VIEW2:WINDow2:TRACe:Y[:SCALE]:COUPle?
Example	DISP:RHO:VIEW2:WIND2:TRAC:Y:COUP ON DISP:RHO:VIEW2:WIND2:TRAC:Y:COUP?
Notes	When this parameter is set to On, pressing the front-panel Restart key, or the Restart key in the Meas Control menu, based on the measurement results if this parameter is set to On. When you set a value to either Scale/Div or Ref Value manually, Auto Scaling is automatically set to Off.
Remote Command Notes	WINDow2: Mag Error window on I/Q Error view
Couplings	See Restriction and Notes
Preset	ON
State Saved	Saved in instrument state.

Range	On Off
Initial S/W Revision	Prior to A.02.00

I/Q Error View – Phase Error Window

When Auto Scaling is On, pressing the Restart front-panel key will result in automatically displaying the scale per division and reference value results for the vertical axis in the phase error window.

Key Path	AMPTD Y Scale
Mode	CDMA2K
Remote Command	:DISPlay:RHO:VIEW2:WINDow3:TRACe:Y[:SCALe]:COUPle 0 1 OFF ON :DISPlay:RHO:VIEW2:WINDow3:TRACe:Y[:SCALe]:COUPle?
Example	DISP:RHO:VIEW2:WIND3:TRAC:Y:COUP ON DISP:RHO:VIEW2:WIND3:TRAC:Y:COUP?
Notes	When this parameter is set to On, pressing the front-panel Restart key, or the Restart key in the Meas Control menu, activates the scale coupling function, that automatically determines scale per division and reference values based on the measurement results. When you set a value to either Scale/Div or Ref Value manually, Auto Scaling is automatically set to Off.
Remote Command Notes	WINDow3: Phase Error window on I/Q Error view
Couplings	See Restriction and Notes
Preset	ON
State Saved	Saved in instrument state.
Range	On Off
Initial S/W Revision	Prior to A.02.00

Auto Couple

The Auto Couple feature provides a quick and convenient way to automatically couple multiple instrument settings. This helps ensure accurate measurements and optimum dynamic range. When the Auto Couple feature is activated, either from the front panel or remotely, all parameters of the current measurement that have an Auto/Manual mode are set to Auto mode and all measurement settings dependent on (or coupled to) the Auto/Man parameters are automatically adjusted for optimal performance.

However, the Auto Couple key actions are confined to the current measurement only. It does not affect other measurements in the mode, and it does not affect markers, marker functions, or trace or display attributes.

See "[More Information](#)" on page 1743

Key Path	Front-panel key
Remote Command	:COUPle ALL NONE
Example	:COUP ALL
Notes	:COUPle ALL puts all Auto/Man parameters in Auto mode (equivalent to pressing the Auto Couple key). :COUPLE NONE puts all Auto/Man parameters in manual mode. It decouples all the coupled instrument parameters and is not recommended for making measurements.
Initial S/W Revision	Prior to A.02.00

More Information

There are two types of functions that have Auto/Manual modes.

Auto/Man Active Function keys

An Auto/Man toggle key controls the binary state associated with an instrument parameter by toggling between Auto (where the parameter is automatically coupled to the other parameters it is dependent upon) and Man (where the parameter is controlled independent of the other parameters), as well as making the parameter the active function. The current mode is indicated on the softkey with either Auto or Man underlined as illustrated below.

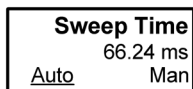

vsd07

Auto/Man 1-of-N keys

An Auto/Man 1-of-N key allows you to manually pick from a list of parameter values, or place the function in Auto, in which case the value is automatically selected (and indicated) as shown below. If in Auto, Auto is underlined on the calling key. If in manual operation, manual is indicated on the calling key. But the calling key does not actually toggle the function, it simply opens the menu.

13 Modulation Accuracy (Composite Rho) Measurement
Auto Couple

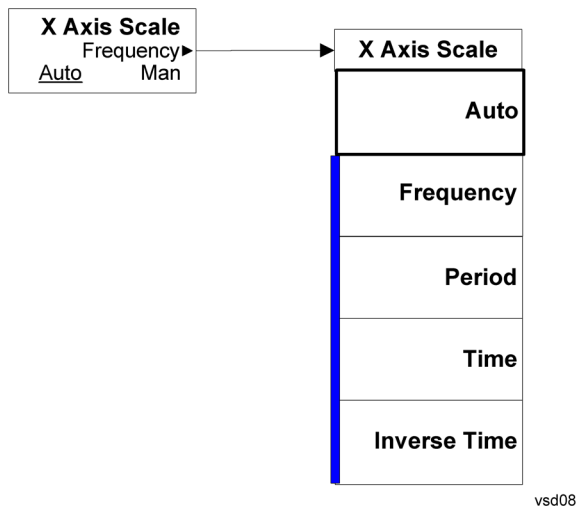

BW

There is no BW functionality supported in the Mod Accuracy measurement. The front-panel key will display a blank menu when pressed.

Key Path	BW
Initial S/W Revision	Prior to A.02.00

Cont (Continuous Measurement/Sweep)

Sets the analyzer for Continuous measurement operation. The single/continuous state is Meas Global so the setting will affect all measurements. If you are Paused, pressing Cont does a Resume.

Key Path	Front-panel key
Remote Command	:INITiate:CONTinuous OFF ON 0 1 :INITiate:CONTinuous?
Example	:INIT:CONT 0 puts analyzer in Single measurement operation. :INIT:CONT 1 puts analyzer in Continuous measurement operation
Preset	ON (Note that SYST:PRESet sets INIT:CONT to ON but *RST sets INIT:CONT to OFF)
State Saved	Saved in instrument state
Backwards Compatibility Notes	For Spectrum Analysis mode in ESA and PSA, there is no Cont hardkey, instead there is a Sweep Single/Cont key. In these analyzers, switching the Sweep Single/Cont key from Single to Cont restarts averages (displayed average count reset to 1), but does not restart Max Hold and Min Hold. The X-Series has Single and Cont keys in place of the SweepSingleCont key. In the X-Series, if in single measurement, the Cont key (and INIT:CONT ON) switches to continuous measurement, but never restarts a measurement and never resets a sweep.
Initial S/W Revision	Prior to A.02.00

In Swept SA Measurement (Spectrum Analysis Mode):

The analyzer takes repetitive sweeps, averages, measurements, etc., when in Continuous mode. When the average count reaches the Average/Hold Number the count stops incrementing, but the analyzer keeps sweeping. See the Trace/Detector section for the averaging formula used both before and after the Average/Hold Number is reached. The trigger condition must be met prior to each sweep. The type of trace processing for multiple sweeps, is set under the Trace/Detector key, with choices of Trace Average, Max Hold, or Min Hold.

In Other Measurements/Modes:

With Avg/Hold Num (in the Meas Setup menu) set to Off or set to On with a value of 1, a sweep is taken after the trigger condition is met; and the analyzer continues to take new sweeps after the current sweep has completed and the trigger condition is again met. However, with Avg/Hold Num set to On with a value >1, multiple sweeps (data acquisitions) are taken for the measurement. The trigger condition must be met prior to each sweep. The sweep is not stopped when the average count k equals the number N set for Avg/Hold Num is reached, but the number k stops incrementing. A measurement average usually applies to all traces, marker results, and numeric results. But sometimes it only applies to the numeric results.

If the analyzer is in Single measurement, pressing the Cont key does not change k and does not cause the sweep to be reset; the only action is to put the analyzer into Continuous measurement operation.

If it is already in continuous sweep:

the INIT:CONT 1 command has no effect

the INIT:CONT 0 command will place the analyzer in Single Sweep but will have no effect on the current sequence until $k = N$, at which point the current sequence will stop and the instrument will go to the idle state.

13 Modulation Accuracy (Composite Rho) Measurement
File

File

See "File" on page 184

FREQ Channel

Accesses a menu of keys that allow you to control the Frequency and Channel parameters of the instrument.

Some features in the Frequency menu are the same for all measurements – they do not change as you change measurements. Settings like these are called “Meas Global” and are unaffected by Meas Preset. For example, the Center Freq setting is the same for all measurements – it does not change as you change measurements.

Key Path	Front-panel key
Initial S/W Revision	Prior to A.02.00

Center Freq

Sets the frequency that corresponds to the horizontal center of the graticule (when frequency Scale Type is set to linear). While adjusting the Center Frequency the Span is held constant, which means that both Start Frequency and Stop Frequency will change.

Pressing Center Freq also sets the frequency entry mode to Center/Span. In Center/Span mode, the center frequency and span values are displayed below the graticule, and the default active function in the Frequency menu is Center Freq.

The center frequency setting is the same for all measurements within a mode, that is, it is Meas Global. Some modes are also able to share a Mode Global center frequency value. If this is the case, the Mode will have a Global Settings key in its Mode Setup menu.

The Center Freq function sets (and queries) the Center Frequency for the currently selected input. If your analyzer has multiple inputs, and you select another input, the Center Freq changes to the value for that input. SCPI commands are available to directly set the Center Freq for a specific input.

Center Freq is remembered as you go from input to input. Thus you can set a Center Freq of 10 GHz with the RF Input selected, change to BBIQ and set a Center Freq of 20 MHz, then switch to External Mixing and set a Center Freq of 60 GHz, and when you go back to the RF Input the Center Freq will go back to 10 GHz; back to BBIQ and it is 20 MHz; back to External Mixing and it is 60 GHz.

See ["RF Center Freq" on page 1752](#)

See [Ext Mix Center Freq](#)

See ["I/Q Center Freq" on page 1754](#)

See ["Center Frequency Presets" on page 1750](#)

Key Path	FREQ Channel
Scope	Meas Global
Remote Command	<code>[:SENSe] :FREQuency:CENTer <freq></code> <code>[:SENSe] :FREQuency:CENTer?</code>
Example	<code>FREQ:CENT 50 MHz</code>

	FREQ:CENT UP changes the center frequency to 150 MHz if you use FREQ:CENT:STEP 100 MHz to set the center frequency step size to 100 MHz FREQ:CENT?
Notes	This command sets either the RF or I/Q Center Frequency depending on the selected input. For RF input it is equivalent to FREQ:RF:CENT For I/Q input it is equivalent to FREQ:IQ:CENT Preset and Max values are dependent on Hardware Options (5xx) If no terminator (e.g. MHz) is sent the terminator Hz is used. If a terminator with unit other than Frequency is used, an invalid suffix error message is generated.
Dependencies	The Center Frequency can be limited by Start or Stop Freq limits, if the Span is so large that Start or Stop reach their limit.
Couplings	When operating in "swept span", any value of the Center Frequency or Span that is within the frequency range of the analyzer is allowed when the value is being set through the front panel numeric key pad or the SCPI command. The other parameter is forced to a different value if needed, to keep the Start and the Stop Frequencies within the analyzer's frequency range
Preset	Depends on instrument maximum frequency, mode, measurement, and selected input. See " Center Frequency Presets " on page 1750 and " RF Center Freq " on page 1752 and Ext Mix Center Freq and " I/Q Center Freq " on page 1754.
State Saved	Saved in instrument state
Min	Depends on instrument maximum frequency, mode, measurement, and selected input.. See " Center Frequency Presets " on page 1750 and " RF Center Freq " on page 1752 and " I/Q Center Freq " on page 1754.
Max	Depends on instrument maximum frequency, mode, measurement, and selected input.. See " Center Frequency Presets " on page 1750 and " RF Center Freq " on page 1752 and " I/Q Center Freq " on page 1754.
Default Unit	Hz
Status Bits/OPC	Non-overlapped
Dependencies	
Initial S/W Revision	Prior to A.02.00

Center Frequency Presets

The following table provides the Center Frequency Presets for the Spectrum Analyzer mode, and the Max Freq, for the various frequency options:

Freq Option	CF after Mode Preset	Stop Freq after Mode Preset	Max Freq (can't tune above)

503 (all but N9000A)	1.805 GHz	3.6 GHz	3.7 GHz
503 (N9000A)	1.505 GHz	3.0 GHz	3.08 GHz
504 (M9420A)	1 GHz	3.8GHz	3.88 GHz
506 (M9420A)	1 GHz	6.0GHz	6.08 GHz
507 (all but N9000A)	3.505 GHz	7.0 GHz	7.1 GHz
507 (N9000A)	3.755 GHz	7.5 GHz	7.58 GHz
508 (all but N9038A)	1.805 GHz	3.6 GHz	8.5 GHz
508 (N9038A)	4.205 GHz	8.4 GHz	8.5 GHz
513	6.805 GHz	13.6 GHz	13.8 GHz
526 (all but N9000A and N9038A)	13.255 GHz	26.5 GHz	27.0 GHz
526 (N9000A)	13.255 GHz	26.5 GHz	26.55 GHz
526 (N9038A)	1.805 GHz	3.6 GHz	27.0 GHz
532	16.005 GHz	32.0 GHz	32.5 GHz
543	21.505 GHz	43.0 GHz	TBD
544	22.005 GHz	44.0 GHz	44.5 GHz
550	25.005 GHz	50.0 GHz	51 GHz

Input 2:

Model	CF after Mode Preset	Stop Freq after Mode Preset	Max Freq (can't tune above)
N9000A opt C75	0.7505GHz	1.5 GHz	1.58 GHz
N9038A	505 MHz	1 GHz	1.000025 GHz

Tracking Generator Frequency Limits (N9000A only):

Tracking Generator Option	Min Freq (clips to this freq when turn TG on and can't tune below while TG on)	If above this Freq, Stop Freq clipped to this Freq when TG turned on	Max Freq (can't tune above) while TG on
T03	9 kHz	3.0 GHz	3.08 GHz
T06	9 kHz	6.0 GHz	6.05 GHz

The following table shows the Center Frequency Presets for modes other than Spectrum Analyzer:

Mode	CF Preset for RF
WCDMA	1 GHz
WIMAXOFDMA,	1 GHz
BASIC	1 GHz
ADEMOD	1 GHz
VSA	1 GHz
TDSCDMA	1 GHz
PNOISE	1 GHz
LTE	1 GHz
LTETDD	1 GHz
MSR	1 GHz
GSM	935.2 MHz
NFIGURE	1.505 GHz

RF Center Freq

SCPI command for specifying the RF Center Frequency. This command will set the Center Frequency to be used when the RF input is selected, even if the RF input is not the input that is selected at the time the command is sent. Note that the Center Freq function in the Frequency menu on the front panel always applies to the currently selected input.

Scope	Meas Global
Remote Command	<code>[:SENSe] :FREQuency:RF:CENTer <freq></code> <code>[:SENSe] :FREQuency:RF:CENTer?</code>
Example	FREQ:RF:CENT 30 MHz
Notes	This command is the same in all modes, but the parameter is Measurement Global. So the value is independent in each mode and common across all the measurements in the mode.
Dependencies	If the electronic/soft attenuator is enabled, any attempt to set Center Frequency such that the Stop Frequency would be >3.6 GHz fails and results in an advisory message. If the equivalent SCPI

	command is sent, this same message is generated as part of a “-221, Settings conflict” warning. If Source Mode is set to Tracking, and the Max or Min Center Freq is therefore limited by the limits of the source, a warning message is generated, “Data out of range;clipped to source max/min” if these limits are exceeded. Note that for an external source, these limits can be affected by the settings of Source Numerator, Source Denominator and Power Sweep.
Preset	See table above
State Saved	Saved in instrument state.
Min	-79.999995 MHz, unless Source Mode is set to Tracking, in which case it is limited by the minimum frequency of the Source
Max	See table above. Basically instrument maximum frequency - 5 Hz. Note that, if the Source Mode is set to Tracking, the effective instrument maximum frequency may be limited by the source maximum frequency. If the knob or step keys are being used, also depends on the value of the other three interdependent parameters Span, Start Frequency and Stop Frequency
Initial S/W Revision	Prior to A.02.00
Modified at S/W Revision	A.03.00

Ext Mix Center Freq

SCPI command for specifying the External Mixer Center Frequency. This command will set the Center Frequency to be used when the External Mixer is selected, even if the External Mixer input is not the input which is selected at the time the command is sent. Note that the Center Freq function in the Frequency menu on the front panel always applies to the currently selected input.

Scope	Meas Global
Remote Command	<code>[:SENSe] :FREQuency:EMIXer:CENTer <freq></code> <code>[:SENSe] :FREQuency:EMIXer:CENTer?</code>
Example	<code>:FREQ:EMIX:CENT 60 GHz</code> <code>:FREQ:EMIX:CENT?</code>
Notes	This command is the same in all modes, but the parameter is Measurement Global. So the value is independent in each mode and common across all the measurements in the mode.
Couplings	When returning to External Mixing after having been switched to one of the other inputs (e.g., RF), you will come back into the settings that you had when you left External Mixing. So you will come back to the band you were in with the Center Frequency that you had. However, Span is not an input-dependent parameter, therefore you will bring the span over from the other input. Therefore, the analyzer comes back with the span from the previous input, limited as necessary by the current mixer setup.
Preset	When a Mode Preset is performed while in External Mixing, the Start frequency of the current Mode is set to the nominal Min Freq of the lowest harmonic range in the Harmonic Table for the current mixer setup. Similarly, the Stop frequency of the current Mode is set to the nominal Max Freq of the highest harmonic range in the Harmonic Table. The Center Freq thus presets to the point arithmetically equidistant from these two frequencies.

	<p>If the current measurement has a limited Span available to it, and cannot achieve the Span shown in the table (Span=Stop Freq – Start Freq), the analyzer uses the maximum Span the measurement allows, and still sets the Center Freq to the midpoint of the Start and Stop Freq values in the Harmonic Table.</p> <p>When Restore Input/Output Defaults is performed, the mixer presets to the 11970A, whose Start and Stop frequencies are 26.5 and 40 GHz respectively. The center of these two frequencies is 33.25 GHz.</p> <p>Therefore, after a Restore Input/Output Defaults, if you go into External Mixing and do a Mode Preset while in the Spectrum Analyzer Mode, the resulting Center Freq is 33.25 GHz.</p>
State Saved	Saved in instrument state.
Min	The minimum frequency in the currently selected mixer band + 5 Hz
Max	The maximum frequency in the currently selected mixer band – 5 Hz If the knob or step keys are being used, also depends on the value of the other three interdependent parameters Span, Start Frequency and Stop Frequency
Initial S/W Revision	A.08.01

I/Q Center Freq

SCPI command for specifying the I/Q Center Frequency. This command will set the Center Frequency to be used when the I/Q input is selected, even if the I/Q input is not the input which is selected at the time the command is sent. Note that the Center Freq function in the Frequency menu on the front panel always applies to the currently selected input.

Scope	Meas Global
Remote Command	[:SENSe] :FREQuency:IQ:CENTer <freq> [:SENSe] :FREQuency:IQ:CENTer?
Example	FREQ:IQ:CEN: 30 MHz
Notes	This command is the same in all modes, but the parameter is Measurement Global. So the value is independent in each mode and common across all the measurements in the mode.
Preset	0 Hz
State Saved	Saved in instrument state.
Min	-40.049995 MHz
Max	40.049995 MHz
Initial S/W Revision	Prior to A.02.00

CF Step

Changes the step size for the center frequency and start and stop frequency functions. Once a step size has been selected and the center frequency function is active, the step keys (and the UP|DOWN parameters for Center Frequency from remote commands) change the center frequency by the step-size value. The step size function is useful for finding harmonics and sidebands beyond the current frequency span of the analyzer.

Note that the start and stop frequencies also step by the CF Step value.

Key Path	FREQ Channel
Remote Command	[:SENSe] :FREQuency:CENTer:STEP [:INCRement] <freq> [:SENSe] :FREQuency:CENTer:STEP [:INCRement] ? [:SENSe] :FREQuency:CENTer:STEP:AUTO OFF ON 0 1 [:SENSe] :FREQuency:CENTer:STEP:AUTO?
Example	FREQ:CENT:STEP:AUTO ON FREQ:CENT:STEP 500 MHz FREQ:CENT UP increases the current center frequency value by 500 MHz FREQ:CENT:STEP? FREQ:CENT:STEP:AUTO?
Notes	Preset and Max values are depending on Hardware Options (503, 507, 508, 513, 526)
Notes	Preset and Max values are dependent on Hardware Options (5xx)
Dependencies	Freq Offset is not available in External Mixing. In this case the Freq Offset key is grayed out and shows a value of zero. It will once again be available, and show the previously set value, when you return to the RF Input.
Dependencies	Span, RBW, Center frequency If the electronic/soft attenuator is enabled, any attempt to change the value of the center frequency >3.6 GHz by pressing the Up-arrow key, fails and results in an advisory message. If the equivalent SCPI command is sent, this same message is generated as part of a “-221, Settings conflict” warning.
Couplings	When auto-coupled in a non-zero span, the center frequency step size is set to 10% of the span. When auto-coupled in zero span, the center frequency step size is set to the equivalent -3 dB RBW value.
Preset	Auto ADEMOD: 1 MHz ON
State Saved	Saved in instrument state
Min	- (the maximum frequency of the instrument). That is, 27 GHz max freq instrument has a CF step range of +/- 27 GHz. Note that this is the maximum frequency given the current settings of the instrument, so in External Mixing, for example, it is the maximum frequency of the current mixer band.
Max	The maximum frequency of the instrument. That is, 27 GHz max freq instrument has a CF step range of +/- 27 GHz. Note that this is the maximum frequency given the current settings of the instrument, so in External Mixing, for example, it is the maximum frequency of the current mixer band.
Default Unit	Hz
Status Bits/OPC dependencies	non-overlapped
Initial S/W Revision	Prior to A.02.00
Modified at S/W Revision	A.03.00

Input/Output

See ["Input/Output" on page 138](#)

Marker

Accesses a menu that enables you to select, set up and control the markers for the current measurement.

Key Path	Front Panel Key
Initial S/W Revision	Prior to A.02.00

Select Marker

Displays 12 markers available for selection.

Key Path	Marker
Initial S/W Revision	Prior to A.02.00

Properties

Accesses a menu that enables you to select a reference marker and marker trace.

Key Path	Marker
Initial S/W Revision	Prior to A.02.00

Select Marker

Displays 12 markers available for selection.

Key Path	Marker
Initial S/W Revision	Prior to A.02.00

Relative To

Selects the marker that the selected marker will be relative to (its reference marker).

Key Path	Marker, Properties
Mode	CDMA2K
Remote Command	:CALCulate:RHO:MARKer[1] 2 ...12:REFerence <integer> :CALCulate:RHO:MARKer[1] 2 ...12:REFerence?
Example	CALC:RHO:MARK:REF 3 CALC:RHO:MARK:REF?
Notes	A marker cannot be relative to itself so that choice is grayed out, and if sent from SCPI generates error -221: "Settings conflict; marker cannot be relative to itself."

Remote Command Notes	When queried a single value will be returned (the specified marker number's relative marker). A marker cannot be relative to itself so that choice is grayed out, and if sent from SCPI generates error -221: "Settings conflict; marker cannot be relative to itself."
Preset	2 3 4 5 6 7 8 9 10 11 12 1
State Saved	Saved in instrument state.
Min	1
Max	12
Initial S/W Revision	Prior to A.02.00

Marker Trace

Assigns the specified marker to the designated trace.

Key Path	Marker
Mode	CDMA2K
Remote Command	:CALCulate:RHO:MARKer[1] 2 ...12:TRACe POLar EVM MERRor PERRor CALCulate:RHO:MARKer[1] 2 ...12:TRACe?
Example	CALC:RHO:MARK2:TRAC EVM CALC:RHO:MARK2:TRACe?
Preset	EVM
State Saved	Saved in instrument state.
Range	POLar EVM MERRor PERRor
Initial S/W Revision	Prior to A.02.00

Couple Markers

Toggles the state of the markers to be coupled On or Off. When this function is true (On), moving any marker causes an "equal X Axis movement" of every other marker which is active. By "equal X Axis movement" we mean that we preserve the difference between each marker's X Axis value (in the fundamental x-axis units of the trace that marker is on) and the X Axis value of the marker being moved (in the same fundamental x-axis units).

See Couple Markers in the "Marker" section for more information.

This may result in markers going off screen.

Key Path	Marker
Mode	CDMA2K
Remote Command	:CALCulate:RHO:MARKer:COUPle[:STATe] ON OFF 1 0 :CALCulate:RHO:MARKer:COUPle[:STATe]?

Example	CALC:RHO:MARK:COUP ON CALC:RHO:MARK:COUP?
Notes	When the marker is assigned to the IQ Measured Polar graph, a Chip value is coupled instead of an X Axis value.
Preset	OFF
State Saved	Saved in instrument state.
Range	On Off
Initial S/W Revision	Prior to A.02.00

All Markers Off

Turns off all markers.

Key Path	Marker
Mode	CDMA2K
Remote Command	:CALCulate:RHO:MARKer:AOff
Example	CALC:RHO:MARK:AOff
Initial S/W Revision	Prior to A.02.00

Marker Chip Value (Remote Command only)

Sets the marker Chip value in the current marker for the I/Q Polar trace. It has no effect if the control mode is Off, but if the control mode is Normal, this is the SCPI equivalent of entering a Chip value.

This command is valid only when Marker Trace 'POLar'(I/Q Polar)is active. For any other Marker Trace, the command is ignored.

Mode	CDMA2K
Remote Command	:CALCulate:RHO:MARKer[1] 2 ...12:CHIP <real> :CALCulate:RHO:MARKer[1] 2 ...12:CHIP?
Example	CALC:RHO:MARK:CHIP 0 CALC:RHO:MARK:CHIP?
Notes	If no suffix is sent, 'chips' will be used. If a suffix is sent that does not match 'chips', an error "Invalid suffix" will be generated. The query returns the marker's 'chips' value in the trace if the control mode is Normal The query is returned in 'chips'. If the marker is Off the response is not a number (NAN).
Remote Command Notes	This parameter has different meanings when the marker trace is set to I/Q Polar and others cases. In the case of the I/Q Polar Graph, the X Axis Value is also the measured value, so this parameter is meaningful only when the control mode is set to Normal.
Preset	0

Preset	Start point of the trace in the display window
State Saved	No
Min	-9.9E+37
Max	9.9E+37
Initial S/W Revision	Prior to A.02.00

Marker X Axis Value (Remote Command only)

Sets the marker X Axis value in the current marker X Axis Scale unit. It has no effect if the control mode is Off, but is the SCPI equivalent of entering an X value if the control mode is Normal or Delta.

Key Path	NA
Mode	CDMA2K
Remote Command	:CALCulate:RHO:MARKer[1] 2 ...12:X <real> :CALCulate:RHO:MARKer[1] 2 ...12:X?

Example	CALC:RHO:MARK3:X 0.0 CALC:RHO:MARK3:X?
----------------	---

Notes	If no suffix is sent, the fundamental units for the current marker X Axis Scale will be used. If a suffix is sent that does not match the current marker X Axis Scale unit, an error "Invalid suffix" will be generated. The query returns the marker's absolute X Axis value if the control mode is Normal,, or the offset from the marker's reference marker, if the control mode is Delta. The query is returned in the fundamental units for the current marker X Axis scale: Hz for Frequency and Inverse Time, seconds for Period and Time. If the marker is Off the response is not a number (NAN).
-------	---

Preset	0
Preset	After a preset, all Markers are turned OFF, so a Marker X Axis Value query will return a not a number (NAN).
State Saved	No
Min	-9.9E+37
Max	9.9E+37.
Initial S/W Revision	Prior to A.02.00

Marker X Axis Position (Remote Command only)

Sets the marker X position in trace points. It has no effect if the control mode is Off, but is the SCPI equivalent of entering a value if the control mode is Normal or Delta - except in trace points rather than X Axis Scale units. The entered value is immediately translated into the current X Axis Scale units for setting the value of the marker.

Mode	CDMA2K
Remote Command	:CALCulate:RHO:MARKer[1] 2 ...12:X:POSition <real> :CALCulate:RHO:MARKer[1] 2 ...12:X:POSition?
Example	CALC:RHO:MARK10:X:POS 0.0 CALC:RHO:MARK10:X:POS?
Notes	The query returns the marker's absolute X Axis value in trace points if the control mode is Normal,, or the offset from the marker's reference marker in trace points, if the control mode is Delta. The value is returned as a real number, not an integer, corresponding to the translation from X Axis Scale units to trace points (see "Fractional Trace Points", above). If the marker is Off the response is not a number (NAN).
Remote Command Notes	This command is not available when Marker Trace of the selected marker (:CALCulate:RHO:MARKer[1] 2 3 4 5 6 7 8 9 10 11 12:TRACe?) is set to POLar. In this case, this command is ignored.
Preset	0
Preset	After a preset, all Markers are turned OFF, so Marker X Axis Value query will return a not a number (NAN).
State Saved	No
Min	-9.9E+37
Max	9.9E+37
Initial S/W Revision	Prior to A.02.00

Marker Y Axis Value (Remote Command only)

Queries the marker Y Axis value in the current unit for the marker Y Axis.

Mode	CDMA2K
Remote Command	:CALCulate:RHO:MARKer[1] 2 ...12:Y?
Example	CALC:RHO:MARK11:Y?
Notes	If no suffix is sent, the current Y Axis unit will be used. If a suffix is sent that is not expressed in units of absolute amplitude, an "Invalid suffix" error will be generated. The query returns the marker Y-axis result if the control mode is Normal or Delta. If the marker is Off the response is not a number (NAN).
Preset	Result dependent on Markers setup and signal source
State Saved	No
Backwards Compatibility SCPI	:CALCulate:RHO:MARKer[1] 2 ...12:FUNCTion:RESult?
Initial S/W Revision	Prior to A.02.00

Meas

The information in this section is common to all measurements. For key and remote command information for a specific measurement, refer to the section that describes the measurement of interest.

Measurements available under the Meas key are specific to the current Mode.

When viewing Help for measurements, note the following:

NOTE

Operation for some keys differs between measurements. The information displayed in Help pertains to the current measurement. To see how a key operates in a different measurement, exit Help (press the Cancel Esc key), select the measurement, then reenter Help (press the Help key) and press that key.

Key Path	Front-panel key
Initial S/W Revision	Prior to A.02.00

Remote Measurement Functions

This section contains the following topics:

"Measurement Group of Commands" on page 2016

"Current Measurement Query (Remote Command Only)" on page 2018

"Limit Test Current Results (Remote Command Only)" on page 2018

"Data Query (Remote Command Only)" on page 2018

"Calculate/Compress Trace Data Query (Remote Command Only)" on page 2019

"Calculate Peaks of Trace Data (Remote Command Only)" on page 2024

"Hardware-Accelerated Fast Power Measurement (Remote Command Only)" on page 2025

"Format Data: Numeric Data (Remote Command Only)" on page 2039

"Format Data: Byte Order (Remote Command Only)" on page 2040

Initial S/W Revision	Prior to A.02.00
----------------------	------------------

Measurement Group of Commands

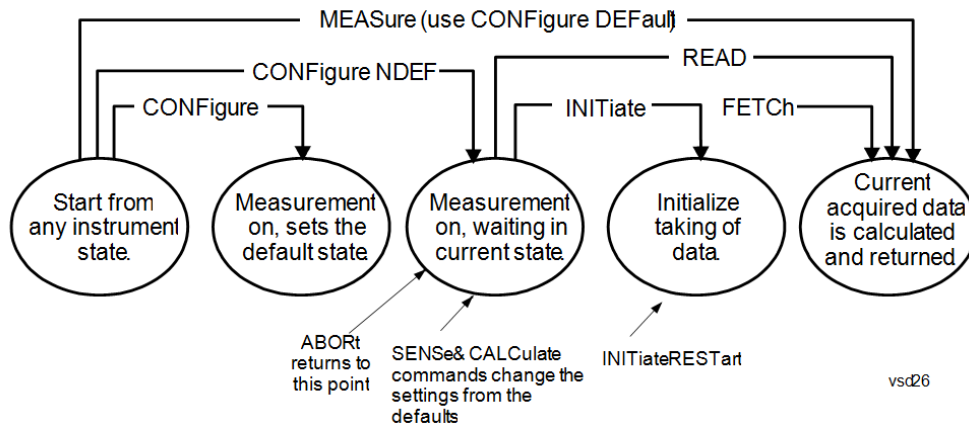

Measure Commands:

:MEASure:<measurement>[n]?

This is a fast single-command way to make a measurement using the factory default instrument settings. These are the settings and units that conform to the Mode Setup settings (e.g. radio standard) that you have currently selected.

- Stops the current measurement (if any) and sets up the instrument for the specified measurement using the factory defaults
- Initiates the data acquisition for the measurement
- Blocks other SCPI communication, waiting until the measurement is complete before returning results.
- If the function does averaging, it is turned on and the number of averages is set to 10.
- After the data is valid it returns the scalar results, or the trace data, for the specified measurement. The type of data returned may be defined by an [n] value that is sent with the command.
- The scalar measurement results will be returned if the optional [n] value is not included, or is set to 1. If the [n] value is set to a value other than 1, the selected trace data results will be returned. See each command for details of what types of scalar results or trace data results are available.
- ASCII is the default format for the data output. (Older versions of Spectrum Analysis and Phase Noise mode measurements only use ASCII.) The binary data formats should be used for handling large blocks of data since they are smaller and faster than the ASCII format. Refer to the FORMat:DATA command for more information.

If you need to change some of the measurement parameters from the factory default settings you can set up the measurement with the CONFIgure command. Use the commands in the SENSE:<measurement> and CALCulate:<measurement> subsystems to change the settings. Then you can use the READ? command to initiate the measurement and query the results.

If you need to repeatedly make a given measurement with settings other than the factory defaults, you can use the commands in the SENSE:<measurement> and CALCulate:<measurement> subsystems to set up the measurement. Then use the READ? command to initiate the measurement and query results.

Measurement settings persist if you initiate a different measurement and then return to a previous one. Use READ:<measurement>? if you want to use those persistent settings. If you want to go back to the default settings, use MEASure:<measurement>?.

Configure Commands:

:CONFIgure:<measurement>

This command stops the current measurement (if any) and sets up the instrument for the specified measurement using

the factory default instrument settings. It does not initiate the taking of measurement data unless INIT:CONTinuous is ON. If you change any measurement settings after using the CONFigure command, the READ command can be used to initiate a measurement without changing the settings back to their defaults.

In the Swept SA measurement in Spectrum Analyzer mode the CONFigure command also turns the averaging function on and sets the number of averages to 10 for all measurements.

:CONFigure: <measurement>: NDEFault stops the current measurement and changes to the specified measurement. It does not change the settings to the defaults. It does not initiate the taking of measurement data unless INIT:CONTinuous is ON.

The CONFigure? query returns the current measurement name.

The CONFigure:CATalog? query returns a quoted string of all licensed measurement names in the current mode. For example, "SAN, CHP, OBW, ACP, PST, TXP, SPUR, SEM, LIST".

Fetch Commands:

:FETCh:<measurement>[n]?

This command puts selected data from the most recent measurement into the output buffer. Use FETCh if you have already made a good measurement and you want to return several types of data (different [n] values, for example, both scalars and trace data) from a single measurement. FETCh saves you the time of re-making the measurement. You can only FETCh results from the measurement that is currently active, it will not change to a different measurement. An error message is reported if a measurement other than the current one is specified.

If you need to get new measurement data, use the READ command, which is equivalent to an INITiate followed by a FETCh.

The scalar measurement results will be returned if the optional [n] value is not included, or is set to 1. If the [n] value is set to a value other than 1, the selected trace data results will be returned. See each command for details of what types of scalar results or trace data results are available. The binary data formats should be used for handling large blocks of data since they are smaller and transfer faster than the ASCII format. (FORMat:DATA)

FETCh may be used to return results other than those specified with the original READ or MEASure command that you sent.

INITiate Commands:

:INITiate:<measurement>

This command is not available for measurements in all the instrument modes:

- Initiates a trigger cycle for the specified measurement, but does not output any data. You must then use the FETCh<meas> command to return data. If a measurement other than the current one is specified, the instrument will switch to that measurement and then initiate it.
- For example, suppose you have previously initiated the ACP measurement, but now you are running the channel power measurement. If you send INIT:ACP? it will change from channel power to ACP and will initiate an ACP measurement.
- Does not change any of the measurement settings. For example, if you have previously started the ACP measurement and you send INIT:ACP? it will initiate a new ACP measurement using the same instrument settings as the last time ACP was run.
- If your selected measurement is currently active (in the idle state) it triggers the measurement, assuming the trigger conditions are met. Then it completes one trigger cycle. Depending upon the measurement and the number of averages, there may be multiple data acquisitions, with multiple trigger events, for one full trigger cycle. It also holds off additional commands on GPIB until the acquisition is complete.

READ Commands:

:READ:<measurement>[n]?

- Does not preset the measurement to the factory default settings. For example, if you have previously initiated the ACP
-

measurement and you send READ:ACP? it will initiate a new measurement using the same instrument settings.

- Initiates the measurement and puts valid data into the output buffer. If a measurement other than the current one is specified, the instrument will switch to that measurement before it initiates the measurement and returns results.
 - For example, suppose you have previously initiated the ACP measurement, but now you are running the channel power measurement. Then you send READ:ACP? It will change from channel power back to ACP and, using the previous ACP settings, will initiate the measurement and return results.
 - Blocks other SCPI communication, waiting until the measurement is complete before returning the results
 - If the optional [n] value is not included, or is set to 1, the scalar measurement results will be returned. If the [n] value is set to a value other than 1, the selected trace data results will be returned. See each command for details of what types of scalar results or trace data results are available. The binary data formats should be used when handling large blocks of data since they are smaller and faster than the ASCII format. (FORMat:DATA)
-

Initial S/W Revision	Prior to A.02.00
----------------------	------------------

Current Measurement Query (Remote Command Only)

This command returns the name of the measurement that is currently running.

Remote Command	:CONFigure?
-----------------------	-------------

Example	CONF?
----------------	-------

Initial S/W Revision	Prior to A.02.00
----------------------	------------------

Limit Test Current Results (Remote Command Only)

Queries the status of the current measurement limit testing. It returns a 0 if the measured results pass when compared with the current limits. It returns a 1 if the measured results fail any limit tests.

Remote Command	:CALCulate:CLIMits:FAIL?
-----------------------	--------------------------

Example	CALC:CLIM:FAIL? queries the current measurement to see if it fails the defined limits. Returns a 0 or 1: 0 it passes, 1 it fails.
----------------	--

Initial S/W Revision	Prior to A.02.00
----------------------	------------------

Data Query (Remote Command Only)

Returns the designated measurement data for the currently selected measurement and subopcode.

n = any valid subopcode for the current measurement. See the measurement command results table for your current measurement, for information about what data is returned for the subopcodes.

This command uses the data setting specified by the FORMat:BORDER and FORMat:DATA commands and can return real or ASCII data. (See the format command descriptions under Input/Output in the Analyzer Setup section.)

Remote Command	:CALCulate:DATA[n]?
Notes	The return trace depends on the measurement. In CALCulate:<meas>:DATA[n], n is any valid subopcode for the current measurement. It returns the same data as the FETCH:<measurement>? query where <measurement> is the current measurement.
Initial S/W Revision	Prior to A.02.00

Calculate/Compress Trace Data Query (Remote Command Only)

Returns compressed data for the currently selected measurement and sub-opcode [n].

n = any valid sub-opcode for that measurement. See the MEASure:<measurement>? command description of your specific measurement for information on the data that can be returned.

The data is returned in the current Y Axis Unit of the analyzer. The command is used with a sub-opcode <n> (default=1) to specify the trace. With trace queries, it is best if the analyzer is not sweeping during the query. Therefore, it is generally advisable to be in Single Sweep, or Update=Off.

This command is used to compress or decimate a long trace to extract and return only the desired data. A typical example would be to acquire N frames of GSM data and return the mean power of the first burst in each frame. The command can also be used to identify the best curve fit for the data.

Remote Command	:CALCulate:DATA<n>:COMPRESS? BLOCK CFIT MAXimum MINimum MEAN DMEan RMS RMSCubed SAMPLE SDEVIation PPHase [,<soffset> [,<length>[,<roffset>[,<rlimit>]]]]
Example	To query the mean power of a set of GSM bursts: Supply a signal that is a set of GSM bursts. Select the IQ Waveform measurement (in IQ Analyzer Mode). Set the sweep time to acquire at least one burst. Set the triggers such that acquisition happens at a known position relative to a burst. Then query the mean burst levels using, CALC:DATA2:COMP? MEAN, 24e-6, 526e-6 (These parameter values correspond to GSM signals, where 526e-6 is the length of the burst in the slot and you just want 1 burst.)
Notes	The command supports 5 parameters. Note that the last 4 (<soffset>, <length>, <roffset>, <rlimit>) are optional. But these optional parameters must be entered in the specified order. For example, if you want to specify <length>, then you must also specify <soffset>. See details below for a definition of each of these parameters. This command uses the data in the format specified by FORMat:DATA, returning either binary or ASCII data.
Initial S/W Revision	Prior to A.02.00

- BLOCK or block data - returns all the data points from the region of the trace data that you specify. For example, it could be used to return the data points of an input signal over several timeslots, excluding the portions of the trace data that you do not want. (This is x,y pairs for trace data and I,Q pairs for complex data.)

- CFIT or curve fit - applies curve fitting routines to the data. <soffset> and <length> are required to define the data that you want. <roffset> is an optional parameter for the desired order of the curve equation. The query will return the following values: the x-offset (in seconds) and the curve coefficients ((order + 1) values).

MIN, MAX, MEAN, DME, RMS, RMSC, SAMP, SDEV and PPH return one data value for each specified region (or <length>) of trace data, for as many regions as possible until you run out of trace data (using <roffset> to specify regions). Or they return the number of regions you specify (using <rlimit>) ignoring any data beyond that.

- MINimum - returns the minimum data point (y value) for the specified region(s) of trace data. For I/Q trace data, the minimum magnitude of the I/Q pairs is returned.
- MAXimum - returns the maximum data point (y value) for the specified region(s) of trace data. For I/Q trace data, the maximum magnitude of the I/Q pairs is returned.
- MEAN - returns a single value that is the arithmetic mean of the data point values (in dB/ dBm) for the specified region(s) of trace data. For I/Q trace data, the mean of the magnitudes of the I/Q pairs is returned. See the following equations.

-

NOTE

If the original trace data is in dB, this function returns the arithmetic mean of those log values, not log of the mean power which is a more useful value. The mean of the log is the better measurement technique when measuring CW signals in the presence of noise. The mean of the power, expressed in dB, is useful in power measurements such as Channel Power. To achieve the mean of the power, use the RMS option.

Equation 1

Mean Value of Data Points for Specified Region(s)

$$MEAN = \frac{1}{n} \sum_{X_i \in \text{region}(s)} X_i$$

where X_i is a data point value, and n is the number of data points in the specified region(s).

Equation 2

Mean Value of I/Q Data Pairs for Specified Region(s)

$$MEAN = \frac{1}{n} \sum_{X_i \in \text{region}(s)} |X_i|$$

where $|X_i|$ is the magnitude of an I/Q pair, and n is the number of I/Q pairs in the specified region(s).

- DMEan - returns a single value that is the mean power (in dB/ dBm) of the data point values for the specified region(s) of trace data. See the following equation:

Equation 3

DMEan Value of Data Points for Specified Region(s)

$$\text{DME} = 10 \times \log_{10} \left(\frac{1}{n} \sum_{X_i \in \text{region}(s)} 10^{\frac{X_i}{10}} \right)$$

- RMS - returns a single value that is the average power on a root-mean-squared voltage scale (arithmetic rms) of the data point values for the specified region(s) of trace data. See the following equation.

NOTE For I/Q trace data, the rms of the magnitudes of the I/Q pairs is returned. See the following equation. This function is very useful for I/Q trace data. However, if the original trace data is in dB, this function returns the rms of the log values which is not usually needed.

Equation 4

RMS Value of Data Points for Specified Region(s)

$$\text{RMS} = \sqrt{\frac{1}{n} \sum_{X_i \in \text{region}(s)} X_i^2}$$

where X_i is a data point value, and n is the number of data points in the specified region(s).

Equation 5

RMS Value of I/Q Data Pairs for Specified Region(s)

$$\text{RMS} = \sqrt{\frac{1}{n} \sum_{X_i \in \text{region}(s)} X_i X_i^*}$$

where X_i is the complex value representation of an I/Q pair, X_i^* its conjugate complex number, and n is the number of I/Q pairs in the specified region(s).

Once you have the rms value for a region of trace data (linear or I/Q), you may want to calculate the mean power. You must convert this rms value (peak volts) to power in dBm:

$$10 \times \log[10 \times (\text{rms value})^2]$$

- SAMPlE - returns the first data value (x,y pair) for the specified region(s) of trace data. For I/Q trace data, the first I/Q pair is returned.
- SDEVIation - returns a single value that is the arithmetic standard deviation for the data point values for the specified region(s) of trace data. See the following equation.
- For I/Q trace data, the standard deviation of the magnitudes of the I/Q pairs is returned. See the following equation.

Equation 6

Standard Deviation of Data Point Values for Specified Region(s)

$$\text{SDEV} = \sqrt{\frac{1}{n} \sum_{X_i \in \text{region}(s)} (X_i - \bar{X})^2}$$

where X_i is a data point value, \bar{X} is the arithmetic mean of the data point values for the specified region (s), and n is the number of data points in the specified region(s).

$$\text{SDEV} = \sqrt{\frac{1}{n} \sum_{X_i \in \text{region}(s)} (|X_i| - \bar{X})^2}$$

where $|X_i|$ is the magnitude of an I/Q pair, \bar{X} is the mean of the magnitudes for the specified region(s), and n is the number of data points in the specified region(s).

- PPHase - returns the x,y pairs of both rms power (dBm) and arithmetic mean phase (radian) for every specified region and frequency offset (Hz). The number of pairs is defined by the specified number of regions. This parameter can be used for I/Q vector ($n=0$) in Waveform (time domain) measurement and all parameters are specified by data point in PPHase.

The rms power of the specified region may be expressed as:

$$\text{Power} = 10 \times \log [10 \times (\text{RMS I/Q value})] + 10.$$

The RMS I/Q value (peak volts) is:

$$\sqrt{\frac{1}{n} \sum_{X_i \in \text{region}} X_i X_i^*}$$

where X_i is the complex value representation of an I/Q pair, X_i^* its conjugate complex number, and n is the number of I/Q pairs in the specified region.

The arithmetic mean phase of the specified region may be expressed as:

$$\frac{1}{n} \sum_{Y_i \in \text{region}} Y_i$$

where Y_i is the unwrapped phase of I/Q pair with applying frequency correction and n is the number of I/Q pairs in the specified region.

The frequency correction is made by the frequency offset calculated by the arithmetic mean of every specified region's frequency offset. Each frequency offset is calculated by the least square method against the unwrapped phase of I/Q pair.

Sample Trace Data - Constant Envelope

(See below for explanation of variables.)

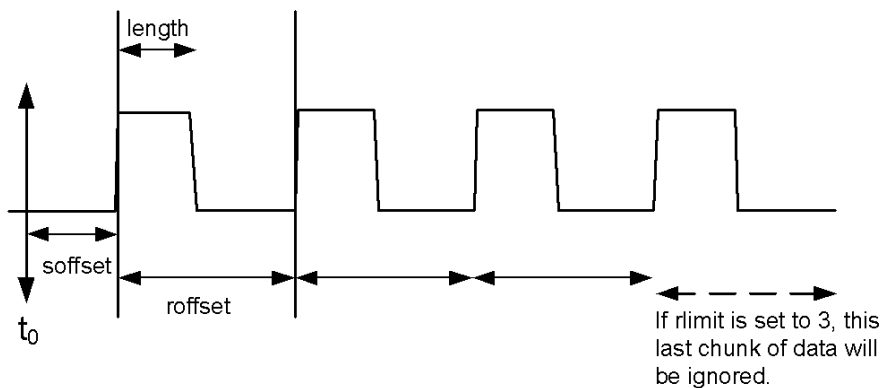

Sample Trace Data - Not Constant Envelope

(See below for explanation of variables.)

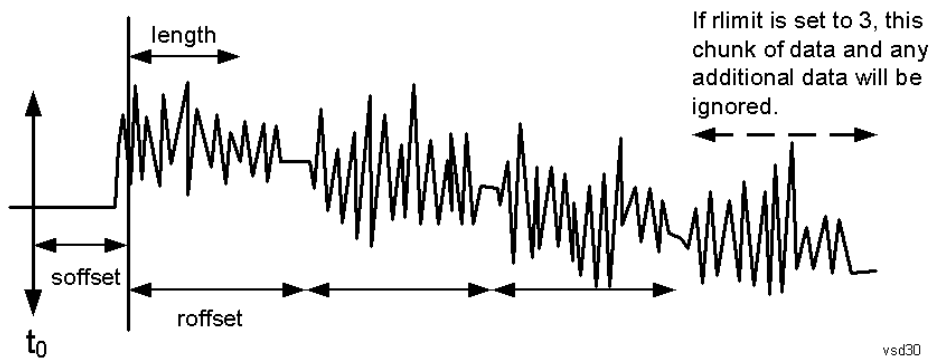

$\langle \text{soffset} \rangle$ - start offset is an optional real number. (It is in seconds for time-domain traces, and is a dimensionless index 0 to $N_{\text{points}} - 1$, for frequency-domain traces). It specifies the amount of data at the beginning of the trace that will be ignored before the decimation process starts. It is the time or frequency change from the start of the trace to the point where you want to start using the data. The default value is zero.

$\langle \text{length} \rangle$ - is an optional real number. (It is in seconds for time-domain traces, and is a dimensionless index 0 to $N_{\text{points}} - 1$, for frequency-domain traces). It defines how much data will be compressed into one value. This parameter has a default value equal to the current trace length.

$\langle \text{roffset} \rangle$ - repeat offset is an optional real number. (It is in seconds for time-domain traces, and is a dimensionless index 0 to $N_{\text{points}} - 1$, for frequency-domain traces). It defines the beginning of the next field of trace elements to be compressed. This is relative to the beginning of the previous field. This parameter has a default value equal to the $\langle \text{length} \rangle$ variable. Note that this parameter is used for a completely different purpose when curve fitting (see CFIT above).

$\langle \text{rlimit} \rangle$ - repeat limit is an optional integer. It specifies the number of data items that you want returned. It will ignore any additional items beyond that number. You can use the Start offset and the Repeat limit to pick out exactly what part of the data you want to use. The default value is all the data.

Calculate Peaks of Trace Data (Remote Command Only)

Returns a list of all the peaks for the currently selected measurement and sub-opcode [n]. The peaks must meet the requirements of the peak threshold and excursion values.

n = any valid sub-opcode for the current measurement. See the MEASure:<measurement> command description of your specific measurement for information on the data that can be returned.

The command can only be used with specific sub-opcodes with measurement results that are trace data. Both real and complex traces can be searched, but complex traces are converted to magnitude in dBm. In many measurements the sub-opcode n=0, is the raw trace data which cannot be searched for peaks. And Sub-opcode n=1, is often calculated results values which also cannot be searched for peaks.

This command uses the data setting specified by the FORMat:BORDER and FORMat:DATA commands and can return real or ASCII data. If the format is set to INT,32, it returns REAL,32 data.

The command has four types of parameters:

- Threshold (in dBm)
- Excursion (in dB)
- Sorting order (amplitude, frequency, time)
- Optional in some measurements: Display line use (all, > display line, < display line)

Remote Command	<p>For Swept SA measurement:</p> <pre>:CALCulate:DATA[1] 2 ... 6:PEAKs? <threshold>,<excursion>[,AMPLitude FREQuency TIME[,ALL GTDLine LTDLine]]</pre> <p>For most other measurements:</p> <pre>:CALCulate:DATA[1] 2 ... 6:PEAKs? <threshold>,<excursion>[,AMPLitude FREQuency TIME]</pre>
-----------------------	--

Example	<p>Example for Swept SA measurement in Spectrum Analyzer Mode:</p> <p>CALC:DATA4:PEAK? -40, 10, FREQ, GTDL This will identify the peaks of trace 4 that are above -40 dBm, with excursions of at least 10 dB. The peaks are returned in order of increasing frequency, starting with the lowest frequency. Only the peaks that are above the display line are returned.</p> <p>Query Results 1:</p> <p>With FORMat:DATA REAL, 32 selected, it returns a list of floating-point numbers. The first value in the list is the number of peak points that are in the following list. A peak point consists of two values: a peak amplitude followed by its corresponding frequency (or time).</p> <p>If no peaks are found the peak list will consist of only the number of peaks, (0).</p>
----------------	---

Notes	<p><n> - is the trace that will be used</p> <p><threshold> - is the level below which trace data peaks are ignored. Note that the threshold value is required and is always used as a peak criterion. To effectively disable the threshold criterion for this command, provide a substantially low threshold value such as -200 dBm. Also note that the threshold value used in this command is independent of and has no effect on the threshold value stored under the Peak Criteria menu.</p> <p><excursion> - is the minimum amplitude variation (rise and fall) required for a signal to be identified as peak. Note that the excursion value is required and is always used as a peak criterion. To effectively disable the excursion criterion for this command, provide the minimum value of 0.0 dB. Also note that the excursion value used in this command is independent of and has no effect on the</p>
--------------	---

excursion value stored under the Peak Criteria menu.

Values must be provided for threshold and excursion. The sorting and display line parameters are optional (defaults are AMPLitude and ALL).

Note that there is always a Y-axis value for the display line, regardless of whether the display line state is on or off. It is the current Y-axis value of the display line which is used by this command to determine whether a peak should be reported

Sorting order:

AMPLitude - lists the peaks in order of descending amplitude, with the highest peak first (default if optional parameter not sent)

FREQUency - lists the peaks in order of occurrence, left to right across the x-axis.

TIME - lists the peaks in order of occurrence, left to right across the x-axis.

Peaks vs. Display Line:

ALL - lists all of the peaks found (default if optional parameter not sent).

GTDLine (greater than display line) - lists all of the peaks found above the display line.

LTDLine (less than display line) - lists all of the peaks found below the display line.

Initial S/W Revision	Prior to A.02.00
----------------------	------------------

Hardware-Accelerated Fast Power Measurement (Remote Command Only)

The Fast Power option (FP2) enables very fast channel power measurements for instruments with the prerequisite hardware (DP2 and/or B40). It accomplishes this by performing real-time overlapped FFTs at the hardware layer, using software for basic post-processing before returning the result to the user. The upshot of this approach is improved throughput for user applications that require many sequential power measurements.

The analysis bandwidth of FP2 is limited by the licenses in the instrument, but its maximum overall analysis bandwidth per acquisition is 40 MHz.

FP2 is remote-only, which means the instrument does not switch to any particular mode or measurement. FP2 commands can be sent while another application is in use on the front panel.

Each Fast Power measurement can be predefined using an array index, and up to 1,000 measurements can be stored. In the following documentation, instances of [1,2,...,999] can be substituted with a particular measurement index, e.g. CALC:FPOW:POW1?, CALC:FPOW:POW2?, CALC:FPOW:POW134?. In this way, power measurements can be defined one time in a batch, and then executed multiple times without having to redefine them, similar to “list mode” on other measurements.

In addition to basic channel power measurements, there are a number of other measurement “functions” for each channel, including peak power, peak frequency, and power spectral density. See the Function parameter for more information.

Reset Fast Power Measurement (Remote Command Only)

Resets the measurement configuration to the defaults.

Mode	All
Remote Command	:CALCulate:FPOWer:POWer[1,2,...,999]:RESet
Example	:CALC:FPOW:POW1:RES

Notes	Option FP2 is required.
Initial S/W Revision	A.14.00

Define Fast Power Measurement (Remote Command Only)

Fast Power acquisitions are configured using the DEFine command. This command accepts a comma-delimited string of configuration parameters and their appropriate values, which are all specified in the subsection below.

Mode	All
Remote Command	:CALCulate:FPOWER:POWer[1,2,...,999]:DEFine "configuration string"
Example	:CALC:FPOW:POW1:DEF "CenterFrequency=2e9, AcquisitionTime=0.005"
Notes	See below for a list of measurement variables that can be defined in the configuration string.
Initial S/W Revision	A.14.00

Acquisition Time

Example	CALC:FPOW:POW1:DEF "AcquisitionTime=0.002"
Notes	The acquisition time parameter sets the time in which the entire spectrum is measured. An increase in the acquisition time yields an improvement in measurement repeatability.
Preset	0.001 s
Range	0 s to 1 s
Default Unit	Time (s)
Initial S/W Revision	A.14.00

Center Frequency

Example	CALC:FPOW:POW1:DEF "CenterFrequency=2e9"
Notes	The center frequency parameter sets the frequency in which the measurement is centered around. The OffsetFrequency parameter is calculated relative to the center frequency.
Preset	1 GHz
Range	0 Hz to maximum instrument frequency
Default Unit	Frequency (Hz)
Initial S/W Revision	A.14.00

DC Coupled

Example	CALC:FPOW:POW1:DEF "DCCoupled=True"
Notes	The DC coupled parameter allows the user to specify whether the DC blocking capacitor is utilized. Set parameter to true when measuring frequencies below 10 MHz.
Preset	False
Range	True (DC Coupled) or False (AC Coupled)
Default Unit	Boolean
Initial S/W Revision	A.14.00

DetectorType

Example	CALC:FPOW:POW1:DEF "DetectorType=Peak"
Notes	Option FP2 is required. The detector type parameter allows the user to choose whether a RMS average or peak value is used during the measurement.
Preset	RmsAverage
Range	RmsAverage, Peak
Initial S/W Revision	A.14.00

Do Noise Correction

Example	CALC:FPOW:POW1:DEF "DoNoiseCorrection=True"
Notes	When noise correction is enabled, the linear noise power contributed by the analyzer is subtracted from all measurements. This effectively lowers the noise floor of the analyzer. When noise correction is enabled, the first measurement for a given set of input parameters will take extra time. This is because the analyzer takes an extra acquisition with the RF input disconnected from the analyzer's front end to measure the noise of just the analyzer. The measured noise floor is stored in a cache so the noise acquisition will occur only once for the same state settings. In other words, if noise correction was turned on and the analyzer made an acquisition at frequency A, then frequency B, and back again to frequency A, the hidden initial noise floor acquisition would only occur for the first acquisition at frequency A and the cached noise floor would be used the second time frequency A was measured.
Preset	False
Range	True (enable noise correction) or False (disable noise correction)
Default Unit	Boolean
Initial S/W Revision	A.14.00

Do Spur Suppression

Example	CALC:FPOW:POW1:DEF "DoSpurSuppression=True"
Notes	<p>When measuring very low level signals, or when large out-of-band inputs are input into the analyzer, sometimes unwanted spurs and residuals can appear in the measured spectrum. Spur suppression is a method to help minimize the levels of these internally generated spurs and residuals.</p> <p>When spur suppression is enabled, the analyzer will automatically take two acquisitions using two different internal analog LO frequencies. The FFT spectrums from both acquisitions are combined by taking the minimum power between both traces on a per FFT bin basis. External signals will have the same amplitude for both traces and therefore will return the expected amplitudes. However, low level spurs and residuals generated internally to the analyzer tend to move to different FFT bins depending on the internal analog LO frequency used, and therefore tend to be suppressed using this spur suppression method.</p> <p>Because two acquisitions, rather than a single acquisition, are made when spur suppression is enabled, the measurement time will always be slower when spur suppression is enabled.</p>
Preset	False
Range	True (enable spur suppression) or False (disable spur suppression)
Default Unit	Boolean
Initial S/W Revision	A.14.00

Electronic Attenuator Bypass

Example	CALC:FPOW:POW1:DEF "ElecAttBypass =False"
Notes	The electronic attenuation bypass parameter allows the user to either utilize or bypass the electronic attenuator. The electronic attenuator is only available for frequencies up to 3.6 GHz. Set parameter to true when using frequencies above 3.6 GHz and set the parameter to false when using the preamp.
Preset	True
Range	True (bypass electronic attenuator) or False (use electronic attenuator)
Default Unit	Boolean
Initial S/W Revision	A.14.00

Electronic Attenuation

Example	CALC:FPOW:POW1:DEF "ElecAttenuation=10"
Notes	<p>Option EA3 is required.</p> <p>The electronic attenuation value parameter sets the amount of electrical attenuation from 0 to 24 dB (1 dB steps).</p> <p>Set "ElecAttBypass=False" to make sure the electronic attenuator path is enabled.</p>
Preset	0 dB
Range	0 – 24 dB (1 dB steps)

Default Unit	dB
Initial S/W Revision	A.14.00

IF Gain

Example	CALC:FPOW:POW1:DEF "IFGain=10"
Notes	The IF gain parameter allows the user to specify the gain at the IF stage anywhere from -6 to 16 dB (1 dB steps). This is an advanced feature, and for most cases this should remain at its default value of 0 dB.
Preset	0 dB
Range	-6 - 16 dB (1 dB steps)
Default Unit	dB
Initial S/W Revision	A.14.00

IF Type

Example	CALC:FPOW:POW1:DEF "IFType=B25M"
Notes	The IF type parameter allows the user to select between different IF paths. For example, if the signal is less than 25 MHz wide, then the user can select the B25M path to take advantage of additional filtering on this analog IF path.
Preset	B40M
Range	B10M, B25M, B40M
Initial S/W Revision	A.14.00

Include Power Spectrum

Example	CALC:FPOW:POW1:DEF "IncludePowerSpectrum=True"
Notes	The power spectrum parameter allows the user to read data on the entire spectrum for diagnostic purposes. It is not recommended for production use. See CALC:FPOW:POW[n]:READ2? for details on the binary format of the response.
Preset	False
Range	True (return both channel power and full power spectrum) or False (returns only channel power)
Default Unit	Boolean
Initial S/W Revision	A.14.00

Mechanical Attenuation

Example	CALC:FPOW:POW1:DEF "MechAttenuation=10"
Notes	The mechanical attenuation value parameter sets the amount of mechanical attenuation anywhere from 0 to 70 dB (2 dB steps).
Preset	0 dB
Range	0 – 70 dB (2 dB steps)
Default Unit	dB
Initial S/W Revision	A.14.00

Preamp Mode

Example	CALC:FPOW:POW1:DEF "PreAmpMode=Low"
Notes	The license for the appropriate preamp is required. The preamp mode parameter specifies whether the preamps are being utilized. Low allows any preamps up to 3.6 GHz, and Full allows all licensed preamps. Set "ElecAttBypass=True" in order to utilize any preamps.
Preset	Off
Range	Off, Low, Full
Initial S/W Revision	A.14.00

Resolution Bandwidth Mode

Example	CALC:FPOW:POW1:DEF "PreAmpMode=Low"
Notes	The resolution bandwidth mode parameter allows the user to choose whether the RBW filter is automatically or manually set. The BestSpeed value minimizes measurement time, while the Narrowest value minimizes RBW size (minimum of two FFT bins per RBW). To manually specify an RBW, set this parameter to Explicit, and set the ResolutionBW parameter to the desired value.
Preset	BestSpeed
Range	BestSpeed, Narrowest, Explicit
Initial S/W Revision	A.14.00

Resolution Bandwidth

Example	CALC:FPOW:POW1:DEF "ResolutionBW=25e3"
Notes	The resolution bandwidth parameter sets the 3-dB bandwidth of the RBW filter. The ResolutionBWMode parameter must be set to Explicit in order to manually set the RBW.

Preset	0 Hz
Default Unit	Hz
Initial S/W Revision	A.14.00

Trigger Delay

Example	CALC:FPOW:POW1:DEF "TriggerDelay=0.025"
Notes	The trigger delay parameter sets the time after an external trigger is detected until the measurement is performed.
Preset	0 s
Range	0 – 1 s
Default Unit	Seconds
Initial S/W Revision	A.14.00

Trigger Level

Example	CALC:FPOW:POW1:DEF "TriggerLevel=2"
Notes	The trigger level parameter sets the voltage value at which an external trigger is detected.
Preset	1.2 V
Range	-5 to 5 V
Default Unit	Volts
Initial S/W Revision	A.14.00

Trigger Slope

Example	CALC:FPOW:POW1:DEF "TriggerSlope=Negative"
Notes	The trigger slope parameter indicates the direction of the edge trigger voltage for detection.
Preset	Positive
Range	Positive, Negative
Initial S/W Revision	A.14.00

Trigger Source

Example	CALC:FPOW:POW1:DEF "TriggerSource=Ext1"
Notes	The trigger source parameter allows the user to choose between measurement's triggering freely or controlled by an external input. Ext1 and Ext2 correspond to Trigger 1 In and Trigger 2 In, respectively.
Preset	Free
Range	Free, Ext1, Ext2
Initial S/W Revision	A.14.00

Trigger Timeout

Example	CALC:FPOW:POW1:DEF "TriggerTimeout=0.1"
Notes	The trigger timeout parameter sets the time in which the analyzer will wait for a trigger before automatically performing the measurement.
Preset	1 s
Range	0 - 1 s
Default Unit	Seconds
Initial S/W Revision	A.14.00

Signal Input

Example	CALC:FPOW:POW1:DEF "SignalInput=Fp50MHzCW"
Notes	The signal input parameter allows the user to select between using the main RF input or the internal analyzer reference CW signal of 50 MHz.
Preset	FpMainRf
Range	FpMainRf, Fp50MHzCW
Initial S/W Revision	A.14.00

Use Preselector

Example	CALC:FPOW:POW1:DEF "UsePreSelector=True"
Notes	The preselector parameter allows the user to either utilize or bypass the front end tunable filter at frequencies above 3.6 GHz. For frequencies below 3.6 GHz, the preselector is automatically bypassed, so you do not need to set this parameter to False in those cases.
Preset	False
Range	True (use preselector above 3.6 GHz), or False (preselector bypassed)

Default Unit	Boolean
Initial S/W Revision	A.14.00

Channel Bandwidth Array

Example	CALC:FPOW:POW1:DEF "Bandwidth=[3.84e6, 5e6, 3.84e6]"
Notes	The bandwidth parameter array defines the bandwidth of each channel that will be measured. All array parameters should have the same number of elements. Alternatively, if all the elements are the same value, a single number with no square brackets can be used to define the parameter.
Preset	[1 e6]
Range	0 to 40 MHz
Default Unit	Hz
Initial S/W Revision	A.14.00

Channel Filter Type Array

Example	CALC:FPOW:POW1:DEF "FilterType=[RRC, IBW, RRC]"
Notes	The filter type parameter allows the user to choose between an integration bandwidth (IBW) filter or a root-raised-cosine (RRC) filter. The integration bandwidth filter weighs all frequencies within the bandwidth equally. The root-raised-cosine filter has an associated shape parameter, defined by the FilterAlpha parameter. All array parameters should have the same number of elements. Alternatively, if all the elements are the same value, a single value with no square brackets can be used to define the parameter.
Preset	[IBW]
Range	IBW, RRC
Initial S/W Revision	A.14.00

Channel Filter Alpha Array

Example	CALC:FPOW:POW1:DEF "FilterAlpha=[0.5, 0.0, 0.5]"
Notes	The filter alpha parameter allows the user to adjust the alpha value associated with the root-raised-cosine (RRC) filter type. Set FilterType to RRC in order to utilize this parameter. All array parameters should have the same number of elements. Alternatively, if all the elements are the same value, a single number with no square brackets can be used to define the parameter.
Preset	[0.22]
Range	0.0 - 1.0

Initial S/W Revision	A.14.00
-------------------------	---------

Channel Measurement Function Array

Example	CALC:FPOW:POW1:DEF "Function=[BandPower, PeakPower, BandPower]"
Notes	This parameter array defines what measurement is being made for each individually-specified channel: BandPower: Total power within the specified bandwidth of the channel (dBm) BandDensity: Total power density within the specified bandwidth of the channel (dBm/Hz) PeakPower: The peak power value within the specified bandwidth of the channel (dBm) PeakFrequency: The frequency which corresponds to the peak power value within the specified bandwidth of the channel. This frequency is relative to the center frequency (Hz) XdBBandwidth: The half power (-3.01 dB) bandwidth of the highest amplitude signal that resides within the channel (Hz), dB is configurable using XdBBandwidth parameter OccupiedBandwidth: The bandwidth at which 99% of the total power resides within the channel (Hz), percentage configurable using OccupiedBandwidthPercent parameter All array parameters should have the same number of elements. Alternatively, if all the elements are the same value, a single value with no square brackets can be used to define the parameter.
Preset	[BandPower]
Range	BandPower, BandDensity, PeakPower, PeakFrequency, XdBBandwidth, OccupiedBandwidth
Initial S/W Revision	A.14.00

Channel Offset Frequency Array

Example	CALC:FPOW:POW1:DEF "OffsetFrequency=[-5e6, 0, 5e6]"
Notes	The offset frequency parameter array defines the difference between the center frequency to the center frequency of each channel. All array parameters should have the same number of elements.
Preset	[0]
Range	0 to 20 MHz
Default Unit	Hz
Initial S/W Revision	A.14.00

Channel Occupied Bandwidth Percent Array

Example	CALC:FPOW:POW1:DEF "OccupiedBandwidthPercent =[0.95, 0.95, 0.95]"
Notes	This parameter only applies for channels whose Function is set to OccupiedBandwidth. The occupied

	bandwidth percent parameter specifies the percent of total power in these channels. The valid range for this parameter is 0.0 to 1.0, where 1.0 represents 100%. The default for this parameter is 0.99, which will return the bandwidth that contains 99% of the total channel power.
Preset	[0.99]
Range	0 – 1.0
Initial S/W Revision	A.14.00

Channel x-dB Bandwidth Array

Example	CALC:FPOW:POW1:DEF " XdBBandwidth =[-6.02, -3.01, -1.0]"
Notes	This parameter only applies for channels whose Function is set to XdBBandwidth. The X dB bandwidth parameter is used to specify the power relative to the peak channel power over which the bandwidth is calculated. The parameter value must be a negative number.
Preset	[-3.01]
Range	-200 to 0 dB
Default Unit	dB
Initial S/W Revision	A.14.00

Define Fast Power Measurement Query (Remote Command Only)

The DEFine? command is used to retrieve a list of all defined parameters in an ASCII string format

```

M All
o
d
e
R :CALCulate:FPOWER:POWer [1,2,...,999]:DEFine?
e
m
o
t
e
C
o
m
m
a
n
d
E :CALC:FPOW:POW1:DEF?

```

x
a
m
p
l
e

N This command query is used to retrieve a list of all defined parameters in an ASCII format.
o The following is an example of the returned results:
t "DCCoupled=False,ElecAttBypass=True,ElecAttenuation=0,IFGain=0,MechAttenuation=0,PreAmpMode=Off,PreSelectorOffset
e =0,UsePreSelector=False,ExternalReferenceFrequency=10000000,FrequencyReferenceSource=AutoExternalFrequencyRefer
s ence,IFType=B40M,LOMode=SLW,SignalInput=FpMainRf,AcquisitionTime=0.001,CenterFrequency=1000000000,Resolution
BW=0,ResolutionBWMode=BestSpeed,DetectorType=RmsAverage,Bandwidth=[1000000],OffsetFrequency=[0],Function=
[BandPower],FilterType=[IBW],FilterAlpha=[0.22],OccupiedBandwidthPercent=[0.99],XdBBandwidth=[-
3.01],DoNoiseCorrection=False,DoSpurSuppression=False,MeasurementMethod=HardwareFFT,IncludePowerSpectrum=False,
e,TriggerDelay=0,TriggerLevel=1.2,TriggerSlope=Positive,TriggerSource=Free,TriggerTimeout=1 "

I A.14.00
n
i
t
i
a
l

S
/
W

R
e
v
i
s
i
o
n

Configure Fast Power Measurement (Remote Command Only)

The configure command begins hardware setup and returns immediately, with no acquisition made. This can be used in parallel with other hardware operations to effectively hide the hardware setup time.

Mode	All
Remote Command	:CALCulate:FPOWer:POWer[1,2,...,999]:CONFigure
Example	:CALC:FPOW:POW1:CONF
Notes	Option FP2 is required.
Initial S/W Revision	A.14.00

Initiate Fast Power Measurement (Remote Command Only)

The INITiate command begins an acquisition and returns immediately. The results of the measurement can be retrieved using FETCh.

Mode	All
Remote Command	:CALCulate:FPOWer:POWer[1,2,...,999]:INITiate
Example	:CALC:FPOW:POW1:INIT
Notes	Option FP2 is required.
Initial S/W Revision	A.14.00

Fetch Fast Power Measurement (Remote Command Only)

The FETCh command query is used to retrieve the results of an acquisition initiated by the INIT command. The returned results are in ASCII string format. The string begins and ends with quotation marks.

Mode	All
Remote Command	:CALCulate:FPOWer:POWer[1,2,...,999]:FETCh?
Example	:CALC:FPOW:POW1:FETC?
Notes	Option FP2 is required. Returns m comma-separated ASCII values, where m corresponds to the number of bandwidths defined. 1. Declared function return in the 1st specified channel 2. Declared function return in the 2nd specified channel ... m. Declared function return in the last specified channel The INIT and FETC? command sequence performs the same functionality of a single CALC:FPOW:POW[n]? query. Units of the returned values are dependent on the Function parameter for each channel.
Initial S/W Revision	A.14.00

Execute Fast Power Measurement (Remote Command Only)

This command query is used as shorthand for an INIT command immediately followed by a FETC? command. The returned results are in ASCII string format. The string begins and ends with quotation marks.

Mode	All
Remote Command	:CALCulate:FPOWer:POWer[1,2,...,999]?
Example	:CALC:FPOW:POW1?

Notes	Option FP2 is required. See notes for Fast Power Fetch for return format.
Initial S/W Revision	A.14.00

Binary Read Fast Power Measurement (Remote Command Only)

This command query is used as shorthand for an INIT command immediately followed by a FETC? command. The returned results are in a binary format.

Mode	All
Remote Command	:CALCulate:FPOWER:POWER[1,2,...,999]:READ? :CALCulate:FPOWER:POWER[1,2,...,999]:READ1?
Example	:CALC:FPOW:POW1:READ? :CALC:FPOW:POW1:READ1?
Notes	Option FP2 is required. Returns m 4 byte floating point binary values (Little-Endian), where m corresponds to the number of bandwidths defined.
Initial S/W Revision	A.14.00

Diagnostic Binary Read Fast Power Measurement (Remote Command Only)

This command query is used as shorthand for an INIT command immediately followed by a FETC? command. The returned results are in a binary format. This command is used primarily for diagnostic purposes to test for ADC overloads and to visibly inspect the spectrum.

Mode	All
Remote Command	:CALCulate:FPOWER:POWER[1,2,...,999]:READ2?
Example	:CALC:FPOW:POW1:READ2?
Notes	Option FP2 is required. Note: Spectrum data is only returned if the IncludePowerSpectrum parameter is set to True. If IncludePowerSpectrum is False, the number of spectrum points will be zero (0). Units of the returned values are dependent on the Function parameter per channel (e.g. dBm for BandPower, Hz for PeakFrequency). Returns binary data (Little-Endian) that contains information on m amount of channels, along with ADC over range and full spectrum data. The following is the binary format of the response. Bandwidth Return Value 1. Number of channels specified, m [4 byte int] 2. Declared function result for the 1st specified channel [4 byte float]

	3. Declared function result for the 2nd specified channel [4 byte float]
	...
	(m + 1). Declared function result for the last (mth) specified channel [4 byte float]
	ADC Over Range
	1. ADC over-range occurred (1: true, 0: false) [2 byte short]
	Spectrum Data
	1. Number of points in the spectrum data, k [4 byte int]
	2. Start frequency of spectrum data (Hz) [8 byte double]
	3. Step frequency of spectrum data (Hz) [8 byte double]
	4. FFT bin at 1st point (dBm) [4 byte float]
	5. FFT bin at 2nd point (dBm) [4 byte float]
	...
	(k + 3). FFT bin at last (kth) point (dBm) [4 byte float]

Initial S/W Revision	A.14.00
-------------------------	---------

Format Data: Numeric Data (Remote Command Only)

This command specifies the format of the trace data input and output. It specifies the formats used for trace data during data transfer across any remote port. It affects only the data format for setting and querying trace data for the :TRACe[:DATA], TRACe[:DATA]?, :CALCulate:DATA[n]? and FETCh:SANalyzer [n]? commands and queries.

Remote Command	:FORMat[:TRACe][:DATA] ASCii INTEger,32 REAL,32 REAL,64 :FORMat[:TRACe][:DATA]?
Notes	The query response is: ASCii: ASC,8 REAL,32: REAL,32 REAL,64: REAL,64 INTEger,32: INT,32 When the numeric data format is REAL or ASCii, data is output in the current Y Axis unit. When the data format is INTEger, data is output in units of m dBm (.001 dBm). The INT,32 format returns binary 32-bit integer values in internal units (m dBm), in a definite length block.
Dependencies	Sending a data format spec with an invalid number (for example, INT,48) generates no error. The analyzer simply uses the default (8 for ASCii, 32 for INTEger, 32 for REAL). Sending data to the analyzer which does not conform to the current FORMat specified, results in an error. Sending ASCII data when a definite block is expected generates message -161 "Invalid Block Data" and sending a definite block when ASCII data is expected generates message -121 "Invalid Character in Number".
Preset	ASCii
Backwards Compatibility	Note that the INT,32 format is only applicable to the command, TRACe:DATA. This preserves

Notes	backwards compatibility for the Swept SA measurement. For all other commands/queries which honor FORMat:DATA, if INT,32 is sent the analyzer will behave as though it were set to REAL,32.
Initial S/W Revision	Prior to A.02.00

The specs for each output type follow:

ASCIi - Amplitude values are in ASCII, in the current Y Axis Unit, one ASCII character per digit, values separated by commas, each value in the form:

SX.YYYYYEsZZ

Where:

S = sign (+ or -)

X = one digit to left of decimal point

Y = 5 digits to right of decimal point

E = E, exponent header

s = sign of exponent (+ or -)

ZZ = two digit exponent

REAL,32 - Binary 32-bit real values in the current Y Axis Unit, in a definite length block.

REAL,64 - Binary 64-bit real values in the current Y Axis Unit, in a definite length block.

Format Data: Byte Order (Remote Command Only)

This command selects the binary data byte order for data transfer and other queries. It controls whether binary data is transferred in normal or swapped mode. This command affects only the byte order for setting and querying trace data for the :TRACe[:DATA], TRACe[:DATA]? , :CALCulate:DATA[n]? and FETCh:SANalyzer[n]? commands and queries.

By definition any command that says it uses FORMat:DATA uses any format supported by FORMat:DATA.

The NORMal order is a byte sequence that begins with the most significant byte (MSB) first, and ends with the least significant byte (LSB) last in the sequence: 1|2|3|4. SWAPped order is when the byte sequence begins with the LSB first, and ends with the MSB last in the sequence: 4|3|2|1.

Remote Command	:FORMat:BORDer NORMal SWAPped :FORMat:BORDer?
Preset	NORMal
Initial S/W Revision	Prior to A.02.00

Meas Setup

Displays the measurement setup menu for the currently selected measurement.

Key Path	Front panel key
Initial S/W Revision	Prior to A.02.00

Avg Number

Sets the number of data acquisitions that will be averaged. After the specified number of average counts is reached, the averaging mode (termination control) setting determines the averaging action.

Key Path	Meas Setup
Mode	CDMA2K
Remote Command	[:SENSe]:RHO:AVERage:COUNT <integer> [:SENSe]:RHO:AVERage:COUNT? [:SENSe]:RHO:AVERage[:STATe] OFF ON 0 1 [:SENSe]:RHO:AVERage[:STATe]?
Example	RHO:AVER:COUN 100 RHO:AVER:COUN? RHO:AVER OFF RHO:AVER?
Preset	10 ON
State Saved	Saved in instrument state.
Min	1
Max	10000
Initial S/W Revision	Prior to A.02.00

Avg Mode

Selects the type of termination control used for the averaging function. This determines the averaging action after the specified number of data acquisitions (average count) is reached. You can select between the Exp (exponential) and Repeat averaging modes. This selection only affects the averaging result after the number of N averages is reached. You can use the Avg Number key to set N.

KEYExponential averaging	When Measure is set at Cont, data acquisitions will continue indefinitely. After N averages, exponential averaging is used with a weighting factor of N (the displayed average count stops at N). Exponential averaging weights new data more than old data, which allows tracking of slow-changing signals.
SCPIEXponential	

KEYRepeat averaging SCPIREpeat	When Measure is set at Cont, data acquisitions will continue indefinitely. After N averages is reached, all previous result data is cleared and the average count is set back to 1. This is equivalent to being in Measure Single and pressing the Restart key when the Single measurement finishes.
-----------------------------------	--

Key Path	Meas Setup
Mode	CDMA2K
Remote Command	[:SENSe] :RHO:AVErAge:TCONtrol EXPonential REPeat [:SENSe] :RHO:AVErAge:TCONtrol?
Example	RHO:AVER:TCON EXP RHO:AVER:TCON?
Preset	REPeat
State Saved	Saved in instrument state.
Range	Exp Repeat
Initial S/W Revision	Prior to A.02.00

Limits

Accesses a menu that allows you to set the following limits:

- RMS EVM (Composite)
- Peak EVM (Composite)
- Rho (Composite)
- Peak Code Domain Error
- Timing Error
- Phase Error

Key Path	Meas Setup
Initial S/W Revision	Prior to A.02.00

RMS EVM (Composite)

Sets the limit for the composite RMS EVM measurement pass/fail test.

Key Path	Meas Setup, Limits
Mode	CDMA2K
Remote Command	:CALCulate:RHO:LIMit:RMS <real>

	:CALCulate:RHO:LIMit:RMS?
Example	CALC:RHO:LIM:RMS 10.0 CALC:RHO:LIM:RMS?
Preset	100.0
State Saved	Saved in instrument state.
Min	0.00
Max	100.00
Initial S/W Revision	Prior to A.02.00

Peak EVM (Composite)

Sets the limit for the composite peak EVM measurement pass/fail test.

Key Path	Meas Setup, Limits
Mode	CDMA2K
Remote Command	:CALCulate:RHO:LIMit:PEAK <real> :CALCulate:RHO:LIMit:PEAK?
Example	CALC:RHO:LIM:PEAK 50.0 CALC:RHO:LIM:PEAK?
Preset	200.0
State Saved	Saved in instrument state.
Min	0.0
Max	200.0
Initial S/W Revision	Prior to A.02.00

Rho (Composite)

Sets the limit for the composite Rho measurement pass/fail test.

Key Path	Meas Setup, Limits
Mode	CDMA2K
Remote Command	:CALCulate:RHO:LIMit:RHO <real> :CALCulate:RHO:LIMit:RHO?
Example	CALC:RHO:LIM:RHO 0.9 CALC:RHO:LIM:RHO?
Notes	The default value of BTS is 0.912 and MS is 0,944.
Preset	BS: 0.912 MS: 0.944

State Saved	Saved in instrument state.
Min	0
Max	1
Initial S/W Revision	Prior to A.02.00

Peak Code Domain Error

Sets the limit for the composite Peak Code Domain Error measurement pass/fail test.

Key Path	Meas Setup, Limits
Mode	CDMA2K
Remote Command	:CALCulate:RHO:LIMit:CDERror <real> :CALCulate:RHO:LIMit:CDERror?
Example	CALC:RHO:LIM:CDER -50.0 CALC:RHO:LIM:CDER?
Preset	0.0
State Saved	Saved in instrument state.
Min	-100
Max	0
Initial S/W Revision	Prior to A.02.00

Timing Error

Sets limit of Timing Offset from Pilot.

Key Path	Meas Setup, Limits
Mode	CDMA2K
Remote Command	:CALCulate:RHO:LIMit:TIMing <float> :CALCulate:RHO:LIMit:TIMing?
Example	CALC:RHO:LIM:TIM 0.000000005 CALC:RHO:LIM:TIM?
Notes	Set limits of Timing Offset from Pilot which is used to judge the result of Pilot Time Offset passes or fails. If a measured Timing Offset from Pilot is not larger than limit value, the result is PASS. Otherwise, the result is FAIL. The default value of BTS is 50 ns, and MS is 10 ns.
Preset	BS: 50 ns MS: 10 ns
State Saved	Saved in instrument state.

Min	0.0 s
Max	500 ns
Initial S/W Revision	Prior to A.02.00

Phase Error

Sets the limit of Phase Offset from Pilot.

Key Path	Meas Setup, Limits
Mode	CDMA2K
Remote Command	:CALCulate:RHO:LIMit:PHASe <float> :CALCulate:RHO:LIMit:PHASe?
Example	CALC:RHO:LIM:PHAS 0.05 CALC:RHO:LIM:PHAS?
Notes	Set limits of Phase Offset from Pilot which is used to judge the result of Pilot Phase Offset passes or fails. If a measured Timing Offset from Pilot is not larger than limit value, the result is PASS. Otherwise, the result is FAIL.
Preset	0.05
State Saved	Saved in instrument state.
Min	0.0
Max	3.0
Initial S/W Revision	Prior to A.02.00

PN Offset

Key Path	Meas Setup, More
Remote Command	:CALCulate:RHO:PNOffset <integer> :CALCulate:RHO:PNOffset?
Example	CALC:RHO:PNOF 5 CALC:RHO:PNOF?
Notes	Sets value for the pseudo-random noise offset. Different pseudo-random noise offsets are used for different base stations. By setting the pseudo-random noise offset to the value that your specific base station is set to, you get the correct time offset value displayed and returned back to you when you query READ:RHO? The instrument, by default, assumes an offset of 0. So, if you do not use this command, you will have to manually calculate the time offset when the value is other than 0.
Remote Command Notes	You must be in cdma2000 mode to use this command.
Preset	0
State Saved	Saved in instrument state.

Min	0
Max	511
Initial S/W Revision	Prior to A.02.00

Sync Type BTS

Accesses the menu that enables you to select the channel to synchronize with, and to set features, such as Symbol Rate, that may affect synchronization. You can select from the following types of channels and features listed in the menu:

F-PICH: Forward Pilot Channel.

Tx-Div F-PICH: Tx diversity forward Pilot Channel.

Key Path	Meas Setup, More 1 of 2
Mode	CDMA2K
Remote Command	[:SENSe] :RHO:SYNC [:BTS] PICH DPICH [:SENSe] :RHO:SYNC [:BTS] ?
Example	RHO:SYNC PICH RHO:SYNC?
Remote Command Notes	This command is effective when [:SENSe]:RADio:DEvIce is set to BTS.
Preset	PICH
State Saved	Saved in instrument state.
Range	F-PICH TxDiv F-PICH
Initial S/W Revision	Prior to A.02.00

Spectrum

Sets a spectrum to either normal or inverted for demodulation related measurements. If set to INVert, the upper and lower spectrums are swapped.

The Invert function conjugates the spectrum, which is equivalent to taking the negative of the quadrature component in demodulation. The correct setting (Normal or Invert) depends on whether the signal at the input of the instrument has a high or low side mix.

Key Path	Meas Setup, More 1 of 2
Mode	CDMA2K
Remote Command	[:SENSe] :RHO:SPECTrum INVert NORMal [:SENSe] :RHO:SPECTrum?
Example	RHO:SPEC INV

	RHO:SPEC?
Preset	NORMal
State Saved	Saved in instrument state.
Range	Normal Invert
Initial S/W Revision	Prior to A.02.00

Advanced

Accesses the menu that allows you to set the I/Q origin offset function, active channel identification function, alpha value of the Root Raised Cosine (RRC) filter, and chip rate.

Key Path	Meas Setup
Initial S/W Revision	Prior to A.02.00

EVM Result I/Q Offset

Toggles the I/Q origin offset function between Include (standard) and Exclude.

–Include: The measurement results for EVM, Rho, and Modulation Accuracy (Rho) error take into account the I/Q origin offset.

–Exclude: The measurement results for EVM, Rho, and Modulation Accuracy (Rho) error do not take into account the I/Q origin offset, and the message “EVM excludes I/Q Offset” is displayed in the lower right-hand graph display area.

Turns the automatic mode On or Off, for the I/Q origin offset function.

–Exclude: OFF – The measurement results for EVM and Rho do not take into account the I/Q origin offset.

–Include: ON – The measurement results for EVM and Rho take into account the I/Q origin offset.

Key Path	Meas Setup, Advanced
Mode	CDMA2K
Remote Command	:CALCulate:RHO:IQOFset:INCLude OFF ON 0 1 :CALCulate:RHO:IQOFset:INCLude?
Example	CALC:RHO:IQOF:INCL ON CALC:RHO:IQOF:INCL?
Preset	ON
State Saved	Saved in instrument state.
Range	Include Exclude
Initial S/W Revision	Prior to A.02.00

Active Threshold

Toggles the active channel identification function between Auto and Man. If set to Auto, the active channels are determined automatically by the internal algorithm. If set to Man, the active channel identification is determined by a user definable threshold ranging from 0.00 to -100.00 dB.

Key Path	Meas Setup, Advanced
Mode	CDMA2K
Remote Command	:CALCulate:RHO:ASET:THReshold <rel_amp1> :CALCulate:RHO:ASET:THReshold? CALCulate:RHO:ASET:THReshold:AUTO OFF ON 0 1 CALCulate:RHO:ASET:THReshold:AUTO?
Example	CALC:RHO:ASET:THR -20.0 CALC:RHO:ASET:THR? CALC:RHO:ASET:THR:AUTO ON CALC:RHO:ASET:THR:AUTO?
Notes	This command is effective when [:SENSe]:RHO:SBOundary[:BTS] is set to AUTO. (For MS, this command is always effective.)
Preset	0.0 ON
State Saved	Saved in instrument state.
Min	-100.0
Max	0.0
Initial S/W Revision	Prior to A.02.00

Filter Alpha

Specifies the alpha value of the complimentary filter.

Key Path	Meas Setup, Advanced
Mode	CDMA2K
Remote Command	[:SENSe]:RHO:ALPHa <real> [:SENSe]:RHO:ALPHa?
Example	RHO:ALPH 0.15 RHO:ALPH?
Preset	0.15
State Saved	Saved in instrument state.
Min	0.05
Max	0.20
Initial S/W Revision	Prior to A.02.00

Chip Rate

Sets the chip rate.

Key Path	Meas Setup, Advanced
Mode	CDMA2K
Remote Command	<code>[:SENSe] :RHO:CRATe <freq></code> <code>[:SENSe] :RHO:CRATe?</code>
Example	RHO:CRAT 1228800 RHO:CRAT?
Preset	1.2288 MHz
State Saved	Saved in instrument state.
Min	1.105925 MHz
Max	1.351680 MHz
Initial S/W Revision	Prior to A.02.00

Multi Channel Estimator

Sets the Multi Channel Estimator On or Off.

Key Path	Meas Setup, Advanced
Mode	CDMA2K
Remote Command	<code>[:SENSe] :RHO:MCEStimator OFF ON 0 1</code> <code>[:SENSe] :RHO:MCEStimator?</code>
Example	RHO: MCES: ON RHO: MCES?
Couplings	Only if Multi Channel Estimator is On, the view of Power, Timing and Phase can work. If Multi Channel Estimator is Off, there will be a message "Press Meas Setup, Advanced and turn Multi Channel Estimation On to see the data" appears on the view of Power, Timing, and Phase.
Preset	Off
State Saved	Saved in instrument state.
Range	On Off
Initial S/W Revision	Prior to A.02.00

Meas Preset

Restores all measurement parameters to their default values.

Key Path	Meas Setup, More 1 of 2
Mode	CDMA2K

13 Modulation Accuracy (Composite Rho) Measurement
Meas Setup

Remote Command	:CONFigure:RHO
Example	CONF:RHO
Initial S/W Revision	Prior to A.02.00

Mode

See "Mode" on page 162

Mode Preset

Returns the active mode to a known state.

Mode Preset does the following for the currently active mode:

- Aborts the currently running measurement.
- Brings up the default menu for the mode, with no active function.
- Sets measurement Global settings to their preset values for the active mode only.
- Activates the default measurement.
- Brings up the default menu for the mode.
- Clears the input and output buffers.
- Sets Status Byte to 0.

Mode Preset does not:

- Cause a mode switch
- Affect mode persistent settings
- Affect system settings
- See "[How-To Preset](#)" on page 1801 for more information.

Key Path	Front-panel key
Remote Command	:SYSTem:PRESet
Example	:SYST:PRES
Notes	*RST is preferred over :SYST:PRES for remote operation. *RST does a Mode Preset, as done by the :SYST:PRES command, and it sets the measurement mode to Single measurement rather than Continuous for optimal remote control throughput. Clears all pending OPC bits. The Status Byte is set to 0.
Couplings	A Mode Preset aborts the currently running measurement, activates the default measurement, and gets the mode to a consistent state with all of the default couplings set.
Backwards Compatibility Notes	In the X-Series, the legacy "Factory Preset" has been replaced with Mode Preset, which only presets the currently active mode, not the entire instrument. In the X-Series, the way to preset the entire instrument is by using System, Restore System Defaults All, which behaves essentially the same way as restore System Defaults does on ESA and PSA. There is also no "Preset Type" as there is on the PSA. There is a green Mode Preset front-panel key that does a Mode Preset and a white-with-green-letters User Preset front-panel key that does a User Preset. The old PRESet:TYPE command is ignored (without generating an error), and SYST:PRES without a parameter does a Mode Preset, which should cover most backward code compatibility issues. The settings and correction data under the Input/Output front-panel key (examples: Input Z Corr, Ext Amp Gain, etc.) are no longer part of any Mode, so they will not be preset by a Mode Preset. They are preset using Restore Input/Output Defaults, Restore System Defaults All. Note that because User Preset does a Recall State, and all of these settings are saved in State, they ARE recalled when using

	User Preset.
Initial S/W Revision	Prior to A.02.00

How-To Preset

The table below shows all possible presets, their corresponding SCPI commands and front-panel access (key paths). Instrument settings depend on the current measurement context. Some settings are local to the current measurement, some are global (common) across all the measurements in the current mode, and some are global to all the available modes. In a similar way, restoring the settings to their preset state can be done within the different contexts.

Auto Couple - is a measurement local key. It sets all Auto/Man parameter couplings in the measurement to Auto. Any Auto/Man selection that is local to other measurements in the mode will not be affected.

Meas Preset - is a measurement local key. Meas Preset resets all the variables local to the current measurement except the persistent ones.

Mode Preset - resets all the current mode's measurement local and measurement global variables except the persistent ones.

Restore Mode Defaults - resets ALL the Mode variables (and all the Meas global and Meas local variables), including the persistent ones.

Type Of Preset	SCPI Command	Front Panel Access
Auto Couple	:COUPlE ALL	Auto Couple front-panel key
Meas Preset	:CONFIgure:<Measurement>	Meas Setup Menu
Mode Preset	:SYSTem:PRESet	Mode Preset (green key)
Restore Mode Defaults	:INSTrument:DEFault	Mode Setup Menu
Restore All Mode Defaults	:SYSTem:DEFault MODEs	System Menu; Restore System Default Menu
*RST	*RST	not possible (Mode Preset with Single)
Restore Input/Output Defaults	:SYSTem:DEFault INPut	System Menu; Restore System Default Menu
Restore Power On Defaults	:SYSTem:DEFault PON	System Menu; Restore System Default Menu
Restore Alignment Defaults	:SYSTem:DEFault ALIGn	System Menu; Restore System Default Menu
Restore Miscellaneous Defaults	:SYSTem:DEFault MISC	System Menu; Restore System Default Menu
Restore All System Defaults	:SYSTem:DEFault [ALL] :SYSTem:PRESet:PERsistent	System Menu; Restore System Default Menu
User Preset	:SYSTem:PRESet:USER	User Preset Menu
User Preset All Modes	:SYSTem:PRESet:USER:ALL	User Preset Menu

13 Modulation Accuracy (Composite Rho) Measurement
Mode Preset

Power On Mode Preset	:SYSTem:PON:TYPE MODE	System Menu
Power On User Preset	:SYSTem:PON:TYPE USER	System Menu
Power On Last State	:SYSTem:PON:TYPE LAST	System Menu

Mode Setup

See "Mode Setup" on page 181

Peak Search

Accesses a menu that enables you to control the peak search function and places a marker on the trace point with highest peak.

Key Path	Front panel key
Mode	CDMA2K
Remote Command	:CALCulate:RHO:MARKer[1] 2 ...12:MAXimum
Example	CALC:RHO:MARK2:MAX
Initial S/W Revision	Prior to A.02.00

Next Peak

Moves the selected marker to the peak that has the next highest amplitude that is less than the marker's current value.

Key Path	Peak Search
Mode	CDMA2K
Remote Command	:CALCulate:RHO:MARKer[1] 2 ...12:MAXimum:NEXT
Example	CALC:RHO:MARK2:MAX:NEXT
Initial S/W Revision	Prior to A.02.00

Next Pk Right

Moves the selected marker to the nearest peak to the right of the current marker that meets all enabled peak criteria.

Key Path	Peak Search
Mode	CDMA2K
Remote Command	:CALCulate:RHO:MARKer[1] 2 ...12:MAXimum:RIGHT
Example	:CALC:RHO:MARK2:MAX:RIGH
Initial S/W Revision	Prior to A.02.00

Next Pk Left

Moves the selected marker to the nearest peak to the left of the current marker that meets all enabled peak criteria.

Key Path	Peak Search
Mode	CDMA2K

Remote Command	:CALCulate:RHO:MARKer [1] 2 . . . 12:MAXimum:LEFT
Example	CALC:RHO:MARK2:MAX:LEFT
Initial S/W Revision	Prior to A.02.00

Marker Delta

Sets the control mode for the selected marker to Delta mode.

Key Path	Peak Search
Initial S/W Revision	Prior to A.02.00

Pk-Pk Search

Finds and displays the amplitude and frequency (or time, if in zero span) differences between the highest and lowest y-axis value.

Key Path	Peak Search
Mode	CDMA2K
Remote Command	:CALCulate:RHO:MARKer [1] 2 . . . 12:PTPeak
Example	CALC:RHO:MARK:PTP
Notes	Turns on the Marker Δ active function.
Couplings	This key is not available (key is grayed out) when Coupled Markers is on.
Initial S/W Revision	Prior to A.02.00

Min Search

Moves the selected marker to the minimum y-axis value on the current trace.

Key Path	Peak Search
Mode	CDMA2K
Remote Command	:CALCulate:RHO:MARKer [1] 2 . . . 12:MINimum
Example	CALC:RHO:MARK:MIN
Initial S/W Revision	Prior to A.02.00

13 Modulation Accuracy (Composite Rho) Measurement
Print

Print

See "[Print](#) " on page 188

Quick Save

The Quick Save front-panel key repeats the most recent save that was performed from the Save menu, with the following exceptions:

- Register saves are not remembered as Saves for the purpose of the Quick Save function
- If the current measurement does not support the last non-register save that was performed, an informational message is generated, “File type not supported for this measurement”

Quick Save repeats the last type of qualified save (that is, a save qualified by the above criteria) in the last save directory by creating a unique filename using the Auto File Naming algorithm described below.

If Quick Save is pressed after startup and before any qualified Save has been performed, the Quick Save function performs a Screen Image save using the current settings for Screen Image saves (current theme, current directory), which then becomes the “last save” for the purpose of subsequent Quick Saves.

The Auto File Naming feature automatically generates a file name for use when saving a file. The filename consists of a prefix and suffix separated by a dot, as is standard for the Windows® file system. A default prefix exists for each of the available file types:

Type	Default Prefix	Menu
State	State_	(Save/Recall)
Trace + State	State_	(Save/Recall)
Screen	Screen_	(Save/Recall)
Amplitude Corrections	Ampcor_	(Import/Export)
Traces	Trace_	(Import/Export)
Limit Lines	LLine_	(Import/Export)
Measurement Result	MeasR_	(Import/Export)
Capture Buffer	CapBuf_	(Import/Export)

A four digit number is appended to the prefix to create a unique file name. The numbering sequence starts at 0000 within each Mode for each file type and updates incrementally to 9999, then wraps to 0000 again. It remembers where it was through a Mode Preset and when leaving and returning to the Mode. It is reset by Restore Misc Defaults and Restore System Defaults and subsequent running of the instrument application. So, for example, the first auto file name generated for State files is State_0000.state. The next is State_0001, and so forth.

One of the key features of Auto File Name is that we guarantee that the Auto File Name will never conflict with an existing file. The algorithm looks for the next available number. If it gets to 9999, then it looks for holes. If it find no holes, that is no more numbers are available, it gives an error.

For example, if when we get to State_0010.state there is already a State_0010.state file in the current directory, it advances the counter to State_0011.state to ensure that no conflict will exist (and then it verifies that State_0011.state also does not exist in the current directory and advances again if it does, and so forth).

If you enter a file name for a given file type, then the prefix becomes the filename you entered instead of the default prefix, followed by an underscore. The last four letters (the suffix) are the 4-digit number.

For example, if you save a measurement results file as “fred.csv”, then the next auto file name chosen for a measurement results save will be fred_0000.csv.

NOTE

Although 0000 is used in the example above, the number that is used is actually the current number in the Meas Results sequence, that is, the number that would have been used if you had not entered your own file name.

NOTE

If the filename you entered ends with _dddd, where d=any number, making it look just like an auto file name, then the next auto file name picks up where you left off with the suffix being dddd + 1.

Key Path	Front-panel key
Notes	No remote command for this key specifically.
Initial S/W Revision	Prior to A.02.00

Recall

The Recall menu lets you choose what you want to recall, and where you want to recall it from. Among the types of files you can recall are **States and Traces**. In addition, an Import (Data) option lets you recall a number of data types stored in CSV files (as used by Excel and other spreadsheet programs).

NOTE

In products that run multiple instances of the X-Series Application, all instances share the same register and file location where you want to recall from.

The default paths for Recall are data type dependent and are the same as for the Save key.

Key Path	Front-panel key
Notes	<p>No remote command for this key specifically, but the :MMEM:LOAD command is available for specific file types. An example is :MMEM:LOAD:STATE <filename>.</p> <p>If you try to recall a State file for a mode that is not licensed or not available in the instrument, an error message will occur and the state will not change.</p>
Backwards Compatibility Notes	<p>In legacy analyzers, it was possible to load a state without affecting the trace data, limit lines or correction data. Similarly (since User Preset is actually loading a state), it was possible to do a User Preset without affecting the trace data, limit lines or correction data.</p> <p>In the X-Series, “state” always includes all of this data; so whenever state is loaded, all of the traces, limit lines and corrections are affected. Although this differs from previous behavior, it is desirable behavior, and should not cause adverse issues for users.</p>
Backwards Compatibility Notes	<p>Recall for the X-Series supports backward compatibility in the sense that you can recall a state file from any X-Series model number and any version of X-Series software. This is only possible if part of the recalling process goes through a limiting step after recalling the mode settings, at least for settings that may vary with version number, model number, option and license differences. If you try to recall a state file onto an instrument with less capability than what was available on the instrument during the save, the recall will ignore the state it doesn't support and it will limit the recalled setting to what it allows.</p> <p>Example: if the saved state includes preamp ON, but the recalling instrument does not have a preamp; the preamp is limited to OFF. Conversely, if you save a state without a preamp, the preamp is OFF in the state file. When this saved file is recalled on an instrument with a licensed preamp, the preamp is changed to OFF. Another example is if the saved state has center frequency set to 20 GHz, but the instrument recalling the saved state is a different model and only supports 13.5 GHz. In this case, the center frequency is limited along with any other frequency based settings. Since the center frequency can't be preserved in this case, the recall limiting tries to at least preserve span to keep the measurement setup as intact as possible.</p> <p>It may be appropriate to issue a warning if the state is limited on the recall; warnings do not go out to SCPI so this would only affect the manual user.</p> <p>Note that there is no state file compatibility outside of the X-Series. For example, you cannot recall a state file from ESA or PSA.</p>
Initial S/W Revision	Prior to A.02.00

State

The Recall State menu lets you choose a register or file from which to recall the state.

The content of a state file includes all of the settings and data required to return the analyzer as closely as possible to the Mode it was in, with the exact settings that were in place, when the save occurred. The Mode settings in each state file include the settings that are affected by Mode Preset, as well as the additional settings affected by Restore Mode Defaults; all of the Mode's settings. In addition, all of the settings of the Input/Output system are included, even though they are outside of the Mode's state, because they are needed to restore the complete setup. Persistent System settings (for example, GPIB address) are not affected by either a Mode Preset or Restore Mode Defaults, nor are they included in a saved State file.

Since each state file is only for one Mode, the settings for other Modes are unaffected when it is loaded. Recall State will cause a mode switch if the state being recalled is not from the current active mode.

After the recall completes, the message "File <filename> recalled" or "Recalled State Register <register number>" is displayed.

For rapid recalls, the State menu lists 16 registers that you can choose from to recall. Pressing a Register key initiates the recall. You can also select a file from which to recall.

The default path for all State Files is:

My Documents\<<mode name>\state

where <mode name> is the parameter used to select the mode with the INST:SEL command (for example, SA for the Spectrum Analyzer).

See ["More Information" on page 1811](#).

Key Path	Recall
Mode	All
Remote Command	:MMEMory:LOAD:STATe <filename>
Example	:MMEM:LOAD:STAT "myState.state" This recalls the file myState.state on the default path
Example	MMEM:LOAD:STAT "MyStateFile.state" This loads the state file data (on the default file directory path) into the instrument state.
Notes	<p>When you pick a file to recall, the analyzer first verifies that the file is recallable in the current instrument by checking the software version and model number of the instrument. If everything matches, a full recall proceeds by aborting the currently running measurement, clearing any pending operations, and then loading the State from the saved state file. You can open state files from any mode, so recalling a State file switches to the mode that was active when the save occurred. After switching to the mode of the saved state file, mode settings and data (if any for the mode) are loaded with values from the saved file. The saved measurement of the mode becomes the newly active measurement and the data relevant to the measurement (if there is any) is recalled.</p> <ul style="list-style-type: none"> • If there is a mismatch between file version or model number or instrument version or model number, the recall function tries to recall as much as possible and returns a warning message. It may limit settings that differ based on model number, licensing or version number. <p>After recalling the state, the Recall State function does the following:</p> <ul style="list-style-type: none"> • Makes the saved measurement for the mode the active measurement. • Clears the input and output buffers. • Status Byte is set to 0.

	<ul style="list-style-type: none"> • Executes a *CLS <p>If the file specified is empty an error is generated. If the specified file does not exist, another error is generated. If there is a mismatch between the file and the proper file type, an error is generated. If there is a mismatch between file version or model number or instrument version or model number, a warning is displayed. Then it returns to the State menu and File Open dialog goes away.</p> <p>After the Recall, the analyzer exits the Recall menu and returns to the previous menu.</p>
Backwards Compatibility SCPI	:MMEMory:LOAD:STATe 1,<filename>
Initial S/W Revision	Prior to A.02.00

More Information

In measurements that support saving Traces, for example, Swept SA, the Trace data is saved along with the State in the State file. When recalling the State, the Trace data is recalled as well. Traces are recalled exactly as they were stored, including the writing mode and update and display modes. If a Trace was updating and visible when the State was saved, it will come back updating and visible, and its data will be rewritten right away. When you use State to save and recall traces, any trace whose data must be preserved should be placed in View or Blank mode before saving.

The following table describes the Trace Save and Recall possibilities:

You want to recall state and one trace's data, leaving other traces unaffected.	Save Trace+State from 1 trace. Make sure that no other traces are updating (they should all be in View or Blank mode) when the save is performed.	On Recall, specify the trace you want to load the one trace's data into. This trace will load in View. All other traces' data will be unaffected, although their trace mode will be as it was when the state save was performed.
You want to recall all traces	Save Trace+State from ALL traces.	On Recall, all traces will come back in View (or Blank if they were in Blank or Background when saved)
You want all traces to load exactly as they were when saved.	Save State	On recall, all traces' mode and data will be exactly as they were when saved. Any traces that were updating will have their data immediately overwritten.

From File...

When you press "From File", the analyzer brings up a Windows dialog and a menu entitled "File Open." This menu allows you to navigate to the various fields in the Windows dialog without using a keyboard or mouse. The Tab and Arrow keys can also be used for dialog navigation.

13 Modulation Accuracy (Composite Rho) Measurement Recall

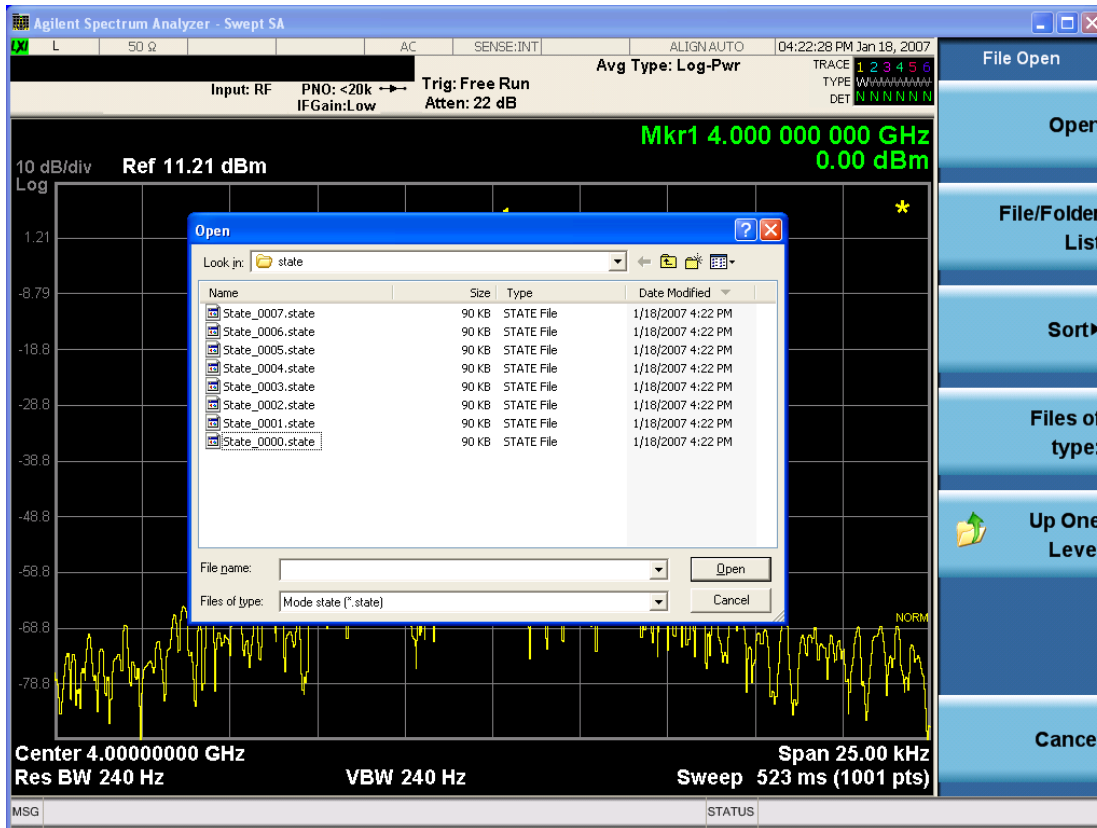

Listed below are the functions of the various fields in the dialog, and the corresponding softkeys:

Open

Performs the recall of the specified file. While the recall is being performed, the floppy icon appears briefly in the Meas bar.

File/Folder List

Enables you to navigate to the center of the dialog that contains the list of files and folders. Once here you can get information about the file and use the tab keys to navigate to the other fields in the dialog, such as Look In.

Look In

The Look In field shows the path from which the file will be recalled and allows you to change the path using the up and down arrow keys to navigate to other paths; the Enter key to open a directory; and the Backspace key to go back one directory. The **Look In field** first uses the last path from the Save As dialog **Save In:** path for that same file type. There is no softkey for directly navigating to the Look In field, but you can use the left tab to get here from the File/Folder List.

User specified paths are remembered when you leave and return to a Mode and are reset back to the default using Restore Mode Defaults.

Sort

Accesses a menu that enables you to sort the files within the File Open dialog. Only one sorting type can be selected at a time and the sorting happens immediately. The sorting types are By Date, By Name, By extension, and By Size.

Files of Type

This field shows the file suffix for the type of file you have selected to recall. For example, if you navigated here while recalling State, "Mode state (*.state)" is in the field. If you navigated here while recalling Trace, ""Mode state (*.trace)" is in the field. If you navigated here while importing a trace data file, "Trace Data (*.csv)" is in the field. For some file types, there is more than one choice in the dropdown menu, which you can select by using the up and down arrow keys and Enter.

Up One Level

This key corresponds to the icon of a folder with the up arrow that is in the tool bar of the dialog. When pressed, it causes the file and folder list to navigate up one level in the directory structure. The Backspace key does the same thing.

Cancel

This key corresponds to the Cancel selection in the dialog. It causes the current **Open** request to be cancelled. The ESC key does the same thing.

Key Path	Recall, State
Notes	Brings up the Open dialog for recalling a State Save Type
Initial S/W Revision	Prior to A.02.00

Edit Register Names

You may enter a custom name on any of the Register keys, to help you remember what you are using that state to save. To do this, press the Edit Register Names key, choose the register whose name you wish to edit, and then enter the desired label using the Alpha Editor or an external PC keyboard.

The maximum number of characters that can be added is 30. In most cases, 30 characters will fit on two lines of the key.

For more information and the SCPI command, see Edit Register Names under the Save, State function.

Key Path	Recall, State
Mode	All
Dependencies	N9060A-7FP or N9060B-2FP license required to edit the register names. When the feature is not licensed, sending the SCPI command generates an error, -221, "Settings conflict;Option not available"
Initial S/W Revision	A.11.00

Register 1 thru Register 16

Selecting any one of these register keys causes the State of the mode from the specified Register to be recalled. Each of the register keys annotates whether it is empty or at what date and time it was last

modified. In addition, you can use the Edit Register Names key under Save, State to enter custom names for each register.

NOTE In products that run multiple instances of the X-Series Application, recalling the same register name on each instance is a way to share setups between the instances.

Registers are shared by all modes, so recalling from any one of the registers will cause a mode switch to the mode that was active when the save to the Register occurred.

Although these 16 registers are the only registers available from the front panel, there are 128 state registers available in the instrument. Registers 17–128 are only available from the SCPI interface, using the *RCL command.

After the recall completes, the message "Register <register number> recalled" appears in the message bar. If you are in the Spectrum Analyzer Mode, and you are recalling a register that was saved in the Spectrum Analyzer Mode, then after the recall, you will still be in the Recall Register menu. If the Recall causes you to switch modes, then after the Recall, you will be in the Frequency menu.

If a requested register is empty an error is generated.

Key Path	Recall, State
Example	*RCL 1
Range	1–16 from front panel, 1–128 from SCPI
Readback	Date and time with seconds resolution are displayed on the key OR A custom name of up to 30 characters entered using the Save, State, Edit Register Names key OR “(empty)” if no prior save operation has been performed to this register.
Initial S/W Revision	Prior to A.02.00
Modified at S/W Revision	Prior to A.11.00

Register 1 thru Register 16

Selecting any one of these register keys causes the State of the mode from the specified Register to be recalled. Each of the register keys annotates whether it is empty or at what date and time it was last modified. In addition, you can use the Edit Register Names key under Save, State to enter custom names for each register.

NOTE In products that run multiple instances of the X-Series Application, recalling the same register name on each instance is a way to share setups between the instances.

Registers are shared by all modes, so recalling from any one of the registers will cause a mode switch to the mode that was active when the save to the Register occurred.

Although these 16 registers are the only registers available from the front panel, there are 128 state registers available in the instrument. Registers 17–128 are only available from the SCPI interface, using the *RCL command.

After the recall completes, the message "Register <register number> recalled" appears in the message bar. If you are in the Spectrum Analyzer Mode, and you are recalling a register that was saved in the Spectrum Analyzer Mode, then after the recall, you will still be in the Recall Register menu. If the Recall causes you to switch modes, then after the Recall, you will be in the Frequency menu.

If a requested register is empty an error is generated.

Key Path	Recall, State
Example	*RCL 1
Range	1-16 from front panel, 1-128 from SCPI
Readback	Date and time with seconds resolution are displayed on the key OR A custom name of up to 30 characters entered using the Save, State, Edit Register Names key OR “(empty)” if no prior save operation has been performed to this register.
Initial S/W Revision	Prior to A.02.00
Modified at S/W Revision	Prior to A.11.00

Sequences

These keys allow you to import a Tab separated or .txt file that will automatically setup all the parameters required for building a Sequence. The parameters will automatically be loaded into the Stated Sequencer.

Once selected, in order to import the selected Sequence Type you must select the Open key in the Source Sequence menu.

Key Path	Recall, Sequences
Mode	All
Remote Command	:MMEMory:LOAD:SEQuences: SLIS ALIS SAALIS "MySequence.txt"
Example	:MMEM:LOAD:SEQ:SLIS "MySequence.txt"
Notes	Available file types are: –CSV (Comma delimited) (*.csv) –Text (Tab delimited) (*.txt)
Initial S/W Revision	A.05.00

Source Sequence

The list of parameters, that configure steps, that makes up a sequence for the Source.

The Source sequence is a sequence of flexible configurable steps that can be set anywhere in the instruments frequency range.

Key Path	Recall, Sequences
----------	-------------------

Example	:MMEM:LOAD:SEQ:SLIS "MySequence.txt"
Dependencies	Only available in XOBT
Initial S/W Revision	A.05.00

Open...

When you press "Open", the analyzer brings up a Windows dialog and a menu entitled "File Open." This menu allows you to navigate to the various fields in the Windows dialog without using a keyboard or mouse. The Tab and Arrow keys can also be used for dialog navigation.

See "From File..." on page 2060 in Recall, State, for a full description of this dialog and menu.

Key Path	Recall, Data
Notes	The key location is mode-dependent and will vary. Brings up Open dialog for recalling a <mode specific> Save Type
Initial S/W Revision	Prior to A.02.00

Data (Import)

Importing a data file loads data that was previously saved from the current measurement or from other measurements and/or modes that produce compatible data files. The Import Menu only contains Data Types that are supported by the current measurement.

Since the commonly exported data files are in .csv format, the data can be edited by the user prior to importing. This allows you to export a data file, manipulate the data in Excel (the most common PC Application for manipulating .csv files) and then import it.

Importing Data loads measurement data from the specified file into the specified or default destination, depending on the data type selected. Selecting an Import Data menu key will not actually cause the importing to occur, since the analyzer still needs to know from where to get the data. Pressing the Open key in this menu brings up the Open dialog and Open menu that provides you with the options from where to recall the data. Once a filename has been selected or entered in the Open menu, the recall occurs as soon as the Open button is pressed.

Key Path	Recall
Mode	All
Notes	The menu is built from whatever data types are available for the mode. Some keys will be missing completely, so the key locations in the sub-menu will vary. No SCPI command directly controls the Data Type that this key controls. The Data Type is included in the MMEM:LOAD commands.
Dependencies	If a file type is not used by a certain measurement, it is grayed out for that measurement. The key for a file type will not show at all if there are no measurements in the Mode that support it.
Preset	Is not affected by Preset or shutdown, but is reset during Restore Mode Defaults

Readback	The data type that is currently selected
Initial S/W Revision	Prior to A.02.00

Capture Buffer

Capture buffer functionality is available only in Code Domain and Modulation Accuracy measurements. The captured data is raw data which is not processed.

Key Path	Recall, Data
Mode	CDMA2000
Example	MMEM:LOAD:CAPT "MyCaptureData.bin" This loads the file of capture data (on the default file directory path) into the instrument.
Dependencies	Capture buffer data is only available for Code Domain and Modulation Accuracy measurement. In other measurements, this key is grayed out.

Open...

When you press "Open", the analyzer brings up a Windows dialog and a menu entitled "**File Open.**" This menu allows you to navigate to the various fields in the Windows dialog without using a keyboard or mouse. The Tab and Arrow keys can also be used for dialog navigation.

See "[From File...](#)" on page 2060 in Recall, State, for a full description of this dialog and menu.

Key Path	Recall, Data
Notes	The key location is mode-dependent and will vary. Brings up Open dialog for recalling a <mode specific> Save Type
Initial S/W Revision	Prior to A.02.00

Restart

The Restart function restarts the current sweep, or measurement, or set of averaged/held sweeps or measurements. If you are Paused, pressing Restart does a Resume.

The Restart function is accessed in several ways:

- Pressing the Restart key
- Sending the remote command INIT:IMMEDIATE
- Sending the remote command INIT:RESTART

See "[More Information](#)" on page 1818

Key Path	Front-panel key
Remote Command	:INITiate[:IMMEDIATE] :INITiate:RESTART
Example	:INIT:IMM :INIT:REST
Notes	:INITiate:RESTART and :INITiate:IMMEDIATE perform exactly the same function.
Couplings	Resets average/hold count k. For the first sweep overwrites all active (update=on) traces with new current data. For application modes, it resets other parameters as required by the measurement.
Status Bits/OPC dependencies	This is an Overlapped command. The STATus:OPERation register bits 0 through 8 are cleared. The STATus:QUESTionable register bit 9 (INTegrity sum) is cleared. The SWEEPING bit is set. The MEASURING bit is set.
Backwards Compatibility Notes	For Spectrum Analysis mode in ESA and PSA, the Restart hardkey and the INITiate:RESTART command restart trace averages (displayed average count reset to 1) for a trace in Clear Write, but did not restart Max Hold and Min Hold. In the X-Series, the Restart hardkey and the INITiate:RESTART command restart not only Trace Average, but MaxHold and MinHold traces as well. For wireless comms modes in ESA and PSA, the Restart hardkey and the INITiate:RESTART command restart every measurement, which includes all traces and numeric results. There is no change to this operation.
Initial S/W Revision	Prior to A.02.00

More Information

The **Restart** function first aborts the current sweep/measurement as quickly as possible. It then resets the sweep and trigger systems, sets up the measurement and initiates a new data measurement sequence with a new data acquisition (sweep) taken once the trigger condition is met.

If the analyzer is in the process of aligning when **Restart** is executed, the alignment finishes before the restart function is performed.

Even when set for Single operation, multiple sweeps may be taken when Restart is pressed (for example, when averaging/holding is on). Thus when we say that **Restart** "restarts a measurement," we may mean:

- It restarts the current sweep
- It restarts the current measurement
- It restarts the current set of sweeps if any trace is in Trace Average, Max Hold or Min Hold
- It restarts the current set of measurements if Averaging, or Max Hold, or Min Hold is on for the measurement
- depending on the current settings.

With **Average/Hold Number** (in **Meas Setup** menu) set to 1, or Averaging off, or no trace in Trace Average or Hold, a single sweep is equivalent to a single measurement. A single sweep is taken after the trigger condition is met; and the analyzer stops sweeping once that sweep has completed. However, with **Average/Hold Number** >1 and at least one trace set to **Trace Average, Max Hold, or Min Hold (SA Measurement)** or **Averaging on (most other measurements)**, multiple sweeps/data acquisitions are taken for a single measurement. The trigger condition must be met prior to each sweep. The sweep is stopped when the average count k equals the number N set for **Average/Hold Number**. A measurement average usually applies to all traces, marker results, and numeric results; but sometimes it only applies to the numeric results.

Once the full set of sweeps has been taken, the analyzer will go to idle state. To take one more sweep without resetting the average count, increment the average count by 1, by pressing the step up key while **Average/Hold Number** is the active function, or sending the remote command `CALC:AVER:TCON UP`.

Save

The Save menu lets you choose what you want to save and where you want to save it. Among the types of files you can save are **States**, **Traces**, and **Screen Images**. In addition, an Export (Data) option lets you save a number of data types as CSV files for easy import into Excel and other spreadsheet programs.

Key Path	Front-panel key
Mode	All
Notes	No remote command for this key specifically, but the :MMEM:STORe command is available for specific file types. An example is :MMEM:STOR:STATe <filename>.
Initial S/W Revision	Prior to A.02.00

State

The Save State menu lets you choose a register or file for saving the state.

NOTE In products that run multiple instances of the X-Series Application, all instances share the same register and file location where you want to save the state.

The content of a state file includes all of the settings and data required to return the analyzer as closely as possible to the Mode it was in, with the exact settings which were in place, when the save occurred. The Mode settings in each state file include the settings that are affected by Mode Preset, as well as the additional settings affected by Restore Mode Defaults; all of the Mode's settings. In addition, all of the settings of the Input/Output system are included, even though they are outside of the Mode's state, because they are needed to restore the complete setup. Persistent System settings (for example, Verbose SCPI) are not affected by either Mode Preset or Restore Mode Defaults, nor are they included in a saved State file.

After the save completes, the message "File <filename> saved" or "State Register <register number> saved" is displayed.

For rapid saving, the State menu lists 16 registers to save to. Pressing a Register key initiates the save. You can also select a file to save to.

The default path for all State Files is:

My Documents\<<mode name>\state

where <mode name> is the parameter used to select the mode with the INST:SEL command (for example, SA for the Spectrum Analyzer).

Key Path	Save
Mode	All
Remote Command	:MMEMory:STORe:STATe <filename>
Example	MMEM:STOR:STATe "MyStateFile.state" This stores the current instrument state data in the file MyStateFile.state in the default directory.
Notes	Both single and double quotes are supported for any filename parameter over remote.

After saving to a register, that register's menu key is updated with the date the time, unless a custom label has been entered for that key.

After saving to a register, you remain in the Save State menu, so that you can see the Register key update. After saving to a file, the analyzer automatically returns to the previous menu and any Save As dialog goes away.

Backwards Compatibility SCPI :MMEMory:STORe:STATe 1,<filename>

For backwards compatibility, the above syntax is supported. The "1" is simply ignored. The command is sequential.

Initial S/W Revision Prior to A.02.00

To File . . .

When you press "To File", the analyzer brings up a Windows dialog and a menu entitled "Save As." This menu allows you to navigate to the various fields in the Windows dialog without using a keyboard or mouse. The Tab and Arrow keys can also be used for dialog navigation.

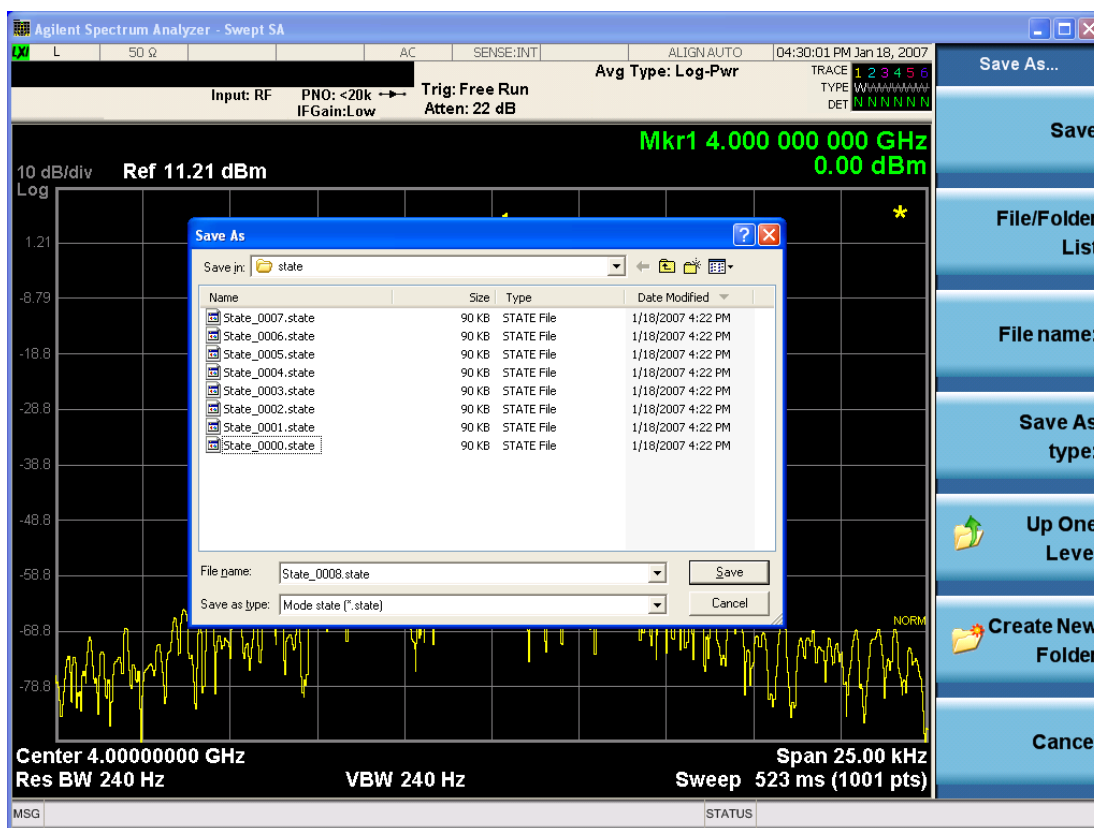

The Listed below

are the functions of the various fields in the dialog, and the corresponding softkeys:

Save

Performs the save to the specified file of the selected type. If the file already exists, a dialog will appear that allows you to replace the existing file by selecting OK, or you can Cancel the request. If you select OK,

the file will be overwritten. Using the C: drive is strongly discouraged, since it runs the risk of being overwritten during an instrument software upgrade.

While the save is being performed, the floppy icon appears briefly in the Meas bar.

File/Folder List

Enables you to navigate to the center of the dialog that contains the list of files and folders. Once here you can get information about the file and use the tab keys to navigate to the other fields in the dialog, such as Save In.

Save In

The Save In field shows the path to which the file will be saved and allows you to change the path using the up and down arrow keys to navigate to other paths; the Enter key to open a directory; and the Backspace key to go back one directory. The **Save In field** defaults to the default path for this type of file and remembers the last path you used to save this type of file. There is no softkey for directly navigating to the Save In field but you can use left tab to get here from the File/Folder List.

User specified paths are remembered when you leave and return to a Mode and are reset back to the default using Restore Mode Defaults.

File Name

The File Name field is initially loaded with an automatically generated filename specific to the appropriate Save Type. The automatically generated filename is guaranteed not to conflict with any filename currently in the directory. You may replace or modify this filename using the File Name key. See the ["Quick Save " on page 2056](#) documentation for more on the automatic file naming algorithm.

When you press the File Name key the analyzer displays the Alpha Editor. Use the knob to choose the letter to add and the front-panel Enter key to add the letter to the file name. The BK character moves you back and the FW character moves you forward in the filename. The Select key on the front panel generates a space character. When you are done entering the filename press the Done softkey. This returns back to the **File Open** dialog and menu, but does not cause the save to occur.

Save As Type

This field shows the file suffix for the type of file you have selected to save. For example, if you navigated here while saving State, "Mode state (*.state)" is in the field. If you navigated here from saving Trace, ""Mode state (*.trace)" is in the field. If you navigated here while exporting a trace data file, "Trace Data (*.csv)" is in the field. For some file types, there is more than one choice in the dropdown, which you can select by using the up and down arrow keys and Enter.

Up One Level

This key corresponds to the icon of a folder with the up arrow that is in the tool bar of the dialog. When pressed, it causes the file and folder list to navigate up one level in the directory structure. The Backspace key does the same thing.

Create New Folder

This key corresponds to the icon of a folder with the "*" that is in the tool bar of the dialog. When pressed, a new folder is created in the current directory with the name **New Folder** and you can enter a new folder name using the Alpha Editor.

Cancel

This key corresponds to the Cancel selection in the dialog. It causes the current **Save As** request to be cancelled. The ESC key does the same thing.

Key Path	Save, State
Mode	All
Notes	Brings up Save As dialog for saving a State Save Type
Initial S/W Revision	Prior to A.02.00

Edit Register Names

You may enter a custom name on any of the Register keys, to help you remember what you are using that state to save. To do this, press the Edit Register Names key, choose the register whose name you wish to edit, and then enter the desired label using the Alpha Editor or an external PC keyboard.

The maximum number of characters that can be added is 30. In most cases, 30 characters will fit on two lines of the key.

See "[More Information](#)" on page 1823

Key Path	Save, State
Mode	All
Remote Command	:MMEMory:REGister:STATe:LABel <reg number>,"label" :MMEMory:REGister:STATe:LABel? <reg number>
Example	:MMEM:REG:STAT:LAB 1,"my label"
Notes	<reg number> is an integer from 1 to 16. If the SCPI specifies an invalid register number an error message is generated, -222,"Data out of range;Invalid register label number" "label" is a string from 0 to 30 characters in length. If a label exceeds 30 characters, an error message is generated, -150,"String data error;Label clipped to 30 characters" "label" of length 0 erases the custom label and restores the default (time and date) label. E.g.: :MMEM:REG:STAT:LAB 1,""
Dependencies	N9060A-7FP or N9060B-2FP license required to edit the register names. When the feature is not licensed, sending this command generates an error, -221,"Settings conflict;Option not available"
Preset	The names are unaffected by Preset or power cycle but are set to the default label (time and date) on a "Restore System Defaults->Misc"
Initial S/W Revision	A.11.00

More Information

When you edit one of the register names, the time and date field will be replaced by the custom name.

If you delete all the characters in the custom name, it restores the default (time and date).

The register names are stored within the state files, but they are not part of the instrument state; that is, once you have edited a register name, loading a new state will not change that register name. Another

consequence of this is that the names will be persistent through a power cycle. Also, if a named state file is transferred to another analyzer, it will bring its custom name along with it.

If you try to edit the name of an empty register, the analyzer will first save the state to have a file to put the name in. If you load a named state file into an analyzer with older firmware it will ignore the metadata.

The *SAV and *RCL commands will not be affected by the custom register names, nor will the MMEM commands.

Register 1 thru Register 16

Selecting any one of these register menu keys causes the State of the currently active mode to be saved to the specified Register. The registers are provided for rapid saving and recalling, since you do not need to specify a filename or navigate to a file. Each of the register menu keys annotates whether it is empty or at what date and time it was last modified. In addition, you can use the Edit Register Names key to enter custom names for each register.

NOTE In products that run multiple instances of the X-Series Application, save with different register name if you do not want to overwrite the register of another running instance.

Although these 16 registers are the only registers available from the front panel, there are 128 state registers available in the instrument. Registers 17–128 are only available from the SCPI interface, using the *SAV command.

There is one set of 128 state registers in the instrument, not one set for each Mode. When a state is saved, the Mode it was saved from is saved with it; then when it is recalled, the instrument switches to that Mode.

After the save completes, the corresponding register menu key annotation is updated with the date and time and the message "Register <register number> saved" is displayed.

Key Path	Save, State
Mode	All
Example	*SAV 1
Range	1–16 from front panel, 1–128 from SCPI
Readback	Date and time with seconds resolution are displayed on the key OR A custom name of up to 30 characters entered using the Edit Register Names key OR “(empty)” if no prior save operation has been performed to this register.
Initial S/W Revision	Prior to A.02.00
Modified at S/W Revision	A.11.00

Register 1 thru Register 16

Selecting any one of these register menu keys causes the State of the currently active mode to be saved to the specified Register. The registers are provided for rapid saving and recalling, since you do not need to specify a filename or navigate to a file. Each of the register menu keys annotates whether it is empty or at

what date and time it was last modified. In addition, you can use the Edit Register Names key to enter custom names for each register.

NOTE In products that run multiple instances of the X-Series Application, save with different register name if you do not want to overwrite the register of another running instance.

Although these 16 registers are the only registers available from the front panel, there are 128 state registers available in the instrument. Registers 17–128 are only available from the SCPI interface, using the *SAV command.

There is one set of 128 state registers in the instrument, not one set for each Mode. When a state is saved, the Mode it was saved from is saved with it; then when it is recalled, the instrument switches to that Mode.

After the save completes, the corresponding register menu key annotation is updated with the date and time and the message "Register <register number> saved" is displayed.

Key Path	Save, State
Mode	All
Example	*SAV 1
Range	1–16 from front panel, 1–128 from SCPI
Readback	Date and time with seconds resolution are displayed on the key OR A custom name of up to 30 characters entered using the Edit Register Names key OR “(empty)” if no prior save operation has been performed to this register.
Initial S/W Revision	Prior to A.02.00
Modified at S/W Revision	A.11.00

Mass Storage Catalog (Remote Command Only)

Key path	SCPI Only
Remote Command	:MMEMory:CATalog? [<directory_name>]
Notes	The string must be a valid logical path. Queries disk usage information (drive capacity, free space available) and obtains a list of files and directories in a specified directory in the following format: <numeric_value>,<numeric_value>,{<file_entry>} It returns two numeric parameters and as many strings as there are files and directories. The first parameter indicates the total amount of storage currently used in bytes. The second parameter indicates the total amount of storage available, also in bytes. The <file_entry> is a string. Each <file_entry> indicates the name, type, and size of one file in the directory list: <file_name>,<file_type>,<file_size> As the windows file system has an extension that indicates file type, <file_type> is always empty. <file_size> provides the size of the file in bytes. For directories, <file_entry> is surrounded by square brackets and both <file_type> and <file_size> are empty
Initial S/W Revision	Prior to A.02.00

Mass Storage Change Directory (Remote Command Only)

Key path	SCPI Only
Remote Command	:MMEMory:CDIRectory [<directory_name>] :MMEMory:CDIRectory?
Notes	The string must be a valid logical path. Changes the default directory for a mass memory file system. The <directory_name> parameter is a string. If no parameter is specified, the directory is set to the *RST value. At *RST, this value is set to the default user data storage area, that is defined as System.Environment.SpecialFolder.Personal. Query returns full path of the default directory.
Initial S/W Revision	Prior to A.02.00

Mass Storage Copy (Remote Command Only)

Key path	SCPI Only
Remote Command	:MMEMory:COPY <string>,<string>[,<string>,<string>]
Notes	The string must be a valid logical path. Copies an existing file to a new file or an existing directory to a new directory. Two forms of parameters are allowed. The first form has two parameters. In this form, the first parameter specifies the source, and the second parameter specifies the destination. The second form has four parameters. In this form, the first and third parameters specify the source. The second and fourth parameters specify the directories. The first pair of parameters specifies the source. The second pair specifies the destination. An error is generated if the source doesn't exist or the destination file already exists. This command will generate an "access denied" error if the destination is a restricted folder (e.g., C:\Windows) and the current user does not have Power User or Administrator privileges.

Mass Storage Device Copy (Remote Command Only)

This command transfers data to/from a file and a peripheral device.

Key path	SCPI Only
Remote Command	:MMEMory:COPY:DEvIce <source_string>,<dest_string>
Notes	The strings must be a valid logical path or a valid device keyword. If the dest_string is a device keyword, the data is copied from the source file to the device. If the source_string is a device keyword, the data is copied to the source file from the device. Valid device keywords are: SNS (smart noise source) An error is generated if the file or device is not found.

Mass Storage Delete (Remote Command Only)

Key path	SCPI Only
Remote Command	:MMEMory:DELeTe <file_name>[,<directory_name>]
Notes	The string must be a valid logical path. Removes a file from the specified directory. The <file_name> parameter specifies the file name to be removed. This command will generate an “access denied” error if the file is in a restricted folder (e.g., C:\Windows) and the current user does not have Power User or Administrator privileges.
Initial S/W Revision	Prior to A.02.00

Mass Storage Data (Remote Command Only)

Creates a file containing the specified data OR queries the data from an existing file.

Key path	SCPI Only
Remote Command	:MMEMory:DATA <file_name>, <data> :MMEMory:DATA? <file_name>
Notes	The string must be a valid logical path. The command form is MMEMory:DATA <file_name>,<data>. It loads <data> into the file <file_name>. <data> is in 488.2 block format. <file_name> is string data. The query form is MMEMory:DATA? <file_name> with the response being the associated <data> in block format.
Initial S/W Revision	Prior to A.02.00

Mass Storage Make Directory (Remote Command Only)

Key path	SCPI Only
Remote Command	:MMEMory:MDIRectory <directory_name>
Notes	The string must be a valid logical path. Creates a new directory. The <directory_name> parameter specifies the name to be created. This command will generate an “access denied” error if the new directory would be in a restricted folder (e.g., C:\Windows) and the current user does not have Power User or Administrator privileges.
Initial S/W Revision	Prior to A.02.00

Mass Storage Move (Remote Command Only)

Key path	SCPI Only
Remote Command	:MMEMory:MOVE <string>,<string>[,<string>,<string>]
Notes	The string must be a valid logical path. Moves an existing file to a new file or an existing directory to a new directory.

Two forms of parameters are allowed. The first form has two parameters. In this form, the first parameter specifies the source, and the second parameter specifies the destination.

The second form has four parameters. In this form, the first and third parameters specify the source. The second and fourth parameters specify the directories. The first pair of parameters specifies the source. The second pair specifies the destination. An error is generated if the source doesn't exist or the destination file already exists.

This command will generate an "access denied" error if the destination is a restricted folder (e.g., C:\Windows) and the current user does not have Power User or Administrator privileges.

Initial S/W Revision Prior to A.02.00

Mass Storage Remove Directory (Remote Command Only)

Key path SCPI Only

Remote Command :MMEMory:RDIRECTory <directory_name>

Notes

The string must be a valid logical path.

Removes a directory. The <directory_name> parameter specifies the directory name to be removed. All files and directories under the specified directory shall also be removed.

This command will generate an "access denied" error if the folder is a restricted folder (e.g., C:\Windows) or is in a restricted folder and the current user does not have Power User or Administrator privileges.

Initial S/W Revision Prior to A.02.00

Mass Storage Determine Removable Media (Remote Command Only)

This command is used to determine if any removable media devices are connected to the instrument. Primarily, these are USB memory devices plugged-in to the front panel or rear panel USB ports. On instruments with PC6 or PC7 CPU's, one SD card slot is available for removable media. The instrument's primary disk drive is not a removable media device.

Key Path SCPI Only

Remote Command :MMEMory:RMEDIA:LIST?

Notes

The return value will be a string containing a list of partition identifiers which are removable media devices. Each identifier will be separated by a comma. If no removable media is present, an empty string will be returned.

Examples:

One removable device present will result in a return string of "F:".

Two removable devices present will result in a return string of "F:,G:".

No removable devices present will result in a return string of "".

Initial S/W Revision x.15.00

Mass Storage Determine Removable Media Label (Remote Command Only)

This command is used to set or query a removable media device's label.

Key Path	SCPI Only
Remote Command	:MMEMory:RMEDia:LABel <partition>,<string> :MMEMory:RMEDia:LABel? <partition>
Example	MMEM:RMED:LAB "F:","My Device"
Notes	If the <partition> specified does not exist or is not a removable media device the error -252,"Missing Media" will be generated. Setting the removable media label requires Administrative privileges. If the currently logged in user does not have appropriate privileges the error "-221.9900,Settings conflict;Administrator privileges required" is generated.
Initial S/W Revision	x.15.00

Mass Storage Determine Removable Media Write-protect status (Remote Command Only)

This command is used to query a removable media device's write-protect status.

Key Path	SCPI Only
Remote Command	:MMEMory:RMEDia:WPRotect? <partition>
Example	MMEM:RMED:WPR? "F:"
Notes	The return value is 1 if the device is write-protected, and 0 if the device is write-enabled. If the <partition> specified does not exist or is not a removable media device the error -252,"Missing Media" will be generated.
Preset	The return value will be depending on SD card installed.
Initial S/W Revision	x.15.00

Mass Storage Determine Removable Media size (Remote Command Only)

This command is used to query a removable media device's total memory size (not available memory size).

Key Path	SCPI Only
Remote Command	:MMEMory:RMEDia:SIZE? <partition>
Example	MMEM:RMED:SIZE? "F:"
Notes	The return value is integer value in GBytes. Any device which is less than 1 GB will return 0 GB. If the <partition> specified does not exist or is not a removable media device the error -252,"Missing Media" will be generated.
Initial S/W Revision	x.15.00

Sequences

These keys allow you to save a Tab separated or CSV file of the setup parameters required to build a Sequence.

In order to save you must select the Save As button and choose a destination folder.

Key Path	Save, Sequences
Mode	All
Remote Command	:MMEM:STOR:SEQ:ences: SLIST ALIST SAAList SSTep "MySequence.txt"
Example	:MMEM:STOR:SEQ:SLIST "MySequence.txt"
Notes	Available file types are: –CSV (Comma delimited) (*.csv) –Text (Tab delimited) (*.txt)
Initial S/W Revision	A.05.00

Source Sequence

The list of parameters, that configure steps, that makes up a sequence for the Source.

The Source sequence is a sequence of flexible configurable steps that can be set anywhere in the instruments frequency range.

Key Path	Save, Sequences
Example	:MMEM:STOR:SEQ:SLIS "MySequence.txt"
Dependencies	Only available in XOBT
Initial S/W Revision	A.05.00

Save As . . .

This menu lets you select the location where you can save the Sequence. This menu is a standard Windows® dialog with Save As menu keys. The "File Name" field in the Save As dialog is initially loaded with an automatically generated filename specific to the appropriate Save Type. The automatically generated filename is guaranteed not to conflict with any filename currently in the directory. You may replace or modify this filename using the File Name softkey. See the Quick Save key documentation for more on the automatic file naming algorithm.

The default path for all Sequence Files is:

My Documents\Sequences

Key Path	Save, Sequences
Mode	All

Notes	Brings up Save As dialog for saving a Sequence Save Type
Initial S/W Revision	A.05.00

Data (Export)

Exporting a data file stores data from the current measurement to mass storage files. The Export Menu only contains data types that are supported by the current measurement.

Since the commonly exported data files are in .csv format, the data can be edited by you prior to importing. This allows you to export a data file, manipulate the data in Excel (the most common PC Application for manipulating .csv files) and then import it.

Selecting an Export Data menu key will not actually cause the exporting to occur, since the analyzer still needs to know where you wish to save the data. Pressing the Save As key in this menu brings up the Save As dialog and Save As menu that allows you to specify the destination file and directory. Once a filename has been selected or entered in the Open menu, the export will occur as soon as the Save key is pressed.

Key Path	Save
Mode	All
Notes	The menu is built from whatever data types are available for the mode. So the key locations in the sub menu will vary. No SCPI command directly controls the Data Type that this key controls. The Data Type is included in the MMEM:STORe commands.
Dependencies	If a file type is not used by a certain measurement, that type is grayed out for that measurement. The key for a file type will not show at all if there are no measurements in the Mode that support it.
Preset	Is not affected by a Preset or shutdown, but is reset during Restore Mode Defaults
Readback	The data type that is currently selected
Initial S/W Revision	Prior to A.02.00

Measurement Results

Pressing this key selects Meas Results as the data type to be exported. Pressing the key a second time brings up the Meas Results menu, which allows you to select which **Meas Result** to save. In the Swept SA measurement, there are three types of Measurement Results files: Peak Table, Marker Table and Spectrogram.

See "[Meas Results File Contents](#)" on page 1832.

See "[Marker Table](#)" on page 1832.

See "[Peak Table](#)" on page 1835.

See "[Spectrogram](#)" on page 1838

Remote Command	:MMEMory:STORe:RESuLts:MTABle PTABle SPECTrogram <filename>
-----------------------	---

Example	<p>:MME:STOR:RES:MTAB "myResults.csv" Saves the results from the current marker table to the file myResults.csv in the current path.</p> <p>:MME:STOR:RES:PTAB "myResults.csv" Saves the results from the current peak table to the file myResults.csv in the current path.</p> <p>:MME:STOR:RES:SPEC "myResults.csv" Saves the results from the current Spectrogram display to the file myResults.csv in the current path.</p> <p>The default path is My Documents\SA\data\SAN\results</p>
Notes	<p>If the save is initiated via SCPI, and the file already exists, the file will be overwritten.</p> <p>Using the C: drive is strongly discouraged, since it runs the risk of being overwritten during an instrument software upgrade.</p> <p>Both single and double quotes are supported for any filename parameter over SCPI.</p>
Dependencies	<p>If a save of Marker Table results is requested and the Marker Table is not on, no file is saved and a message is generated</p> <p>If a save of Peak Table results is requested and the Peak Table is not on, no file is saved and a message is generated</p> <p>If a save of Spectrogram results is requested and the Spectrogram is not on, no file is saved and a message is generated.</p> <p>The Spectrogram choice only appears if option EDP is licensed.</p>
Preset	Not part of Preset, but is reset to Peak Table by Restore Mode Defaults. Survives a shutdown.
Initial S/W Revision	Prior to A.02.00

Meas Results File Contents

All files are .csv files. The following section details the data in each file type.

Marker Table

This section discusses the Marker Table Meas Results file format.

Imagine that, at the point where a Marker Table Meas Result is requested, the following screen is showing:

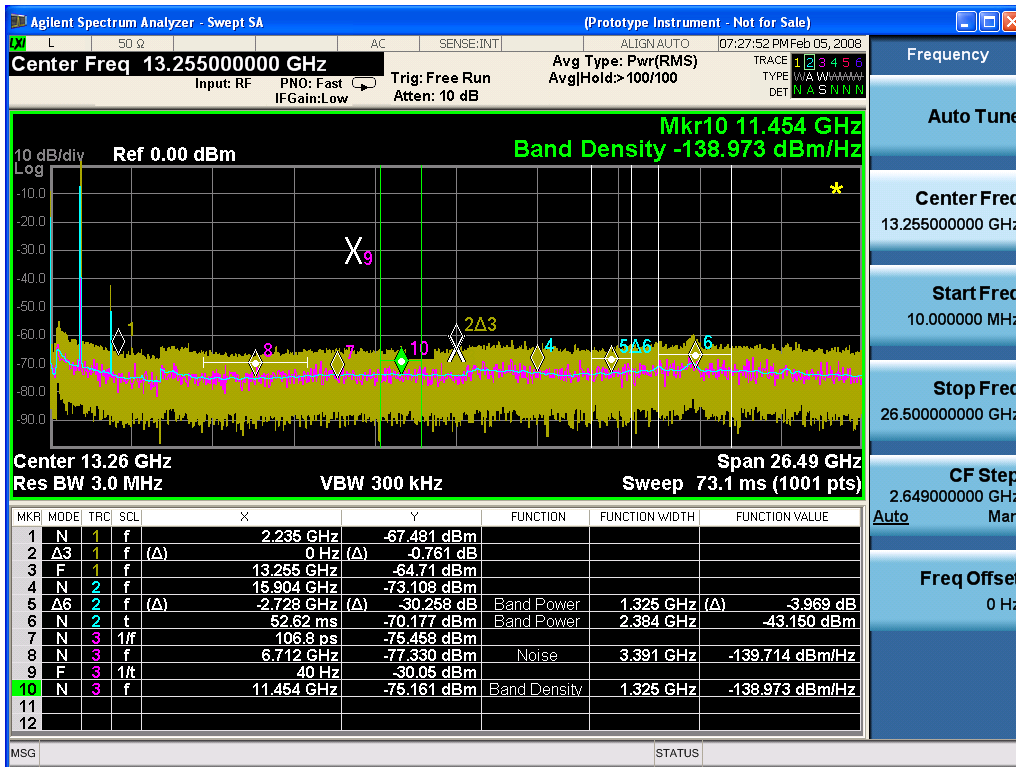

Then the Meas Results file, when opened, would show the following data:

MeasurementR	
result	
Swept SA	
A.01.40_R0017	N9020A
526 B25 PFR	1
P26 EA3	
Result Type	Marker Table
Ref Level	0
Number of Points	1001
Sweep Time	0.0662666 67
Start Frequency	10000000
Stop Frequency	26500000 000
Average Count	0
Average Type	LogPower (Video)
RBW	3000000

13 Modulation Accuracy (Composite Rho) Measurement
Save

RBW Filter	Gaussian
RBW Filter BW	3dB
VBW	3000000
Sweep Type	Swept
X Axis Scale	Lin
PreAmp State	Off
PreAmp Band	Low
Trigger Source	Free
Trigger Level	1.2
Trigger Slope	Positive
Trigger Delay	1.00E-06
Phase Noise Optimization	Fast
Swept If Gain	Low
FFT If Gain	Autorange
RF Coupling	AC
FFT Width	411900
Ext Ref	10000000
Input	RF
RF Calibrator	Off
Attenuation	10
Ref Level Offset	0
External Gain	0
X Axis Units	Hz
Y Axis Units	dBm

DATA									
MKR	MODE	TR C	SCL	X	Y	FUNCTI ON	FUNCTIO N WIDTH	FUNCTI ON VALUE	FUNCTI ON UNIT
1	Normal	1	Freque ncy	2.2350E+09	- 67.481	Off	0.0000E+00	0	None
2	Delta3	1	Freque ncy	0.0000E+00	- 0.761	Off	0.0000E+00	0	None
3	Fixed	1	Freque ncy	1.3255E+10	- 64.71	Off	0.0000E+00	0	None
4	Normal	2	Freque ncy	1.5904E+10	- 73.1	Off	0.0000E+00	0	None

08									
5	Delta7	2	Freque ncy	- 2.7280E+ 09	- 30.2 58	Band Power	1.3250E+ 06	-3.969	dB
6	Normal	2	Time	5.2620E- 02	- 70.1 77	Band Power	2.3840E+ 06	-43.15	dBm
7	Normal	3	Period	1.0680E- 10	- 75.4 58	Off	0.0000E+ 00	0	None
8	Normal	3	Freque ncy	6.7120E+ 09	- 77.3 3	Noise	3.3910E+ 06	- 139.71 4	dBm/Hz
9	Fixed	3	Inverse Time	4.0000E+ 01	- 30.0 5	Off	0.0000E+ 00	0	None
10	Normal	3	Freque ncy	1.1454E+ 10	- 75.1 61	Band Density	1.3250E+ 06	- 138.97 3	dBm/Hz
11	Off	1	Freque ncy	0.0000E+ 00	0	Off	0.0000E+ 00	0	None
12	Off	1	Freque ncy	0.0000E+ 00	0	Off	0.0000E+ 00	0	None

The numbers appear in the file exactly as they appear onscreen. If it says 11.454 GHz onscreen, then in the file it is 11.454E+09.

The metadata header is very similar to the metadata used in the trace data .csv files. See Trace File Contents. The only new information concerns the 1-of-N fields in the marker table itself.

Peak Table

This section discusses the Peak Table Meas Results file format.

Imagine that, at the point where a Marker Table Meas Result is requested, the following screen is showing:

13 Modulation Accuracy (Composite Rho) Measurement
Save

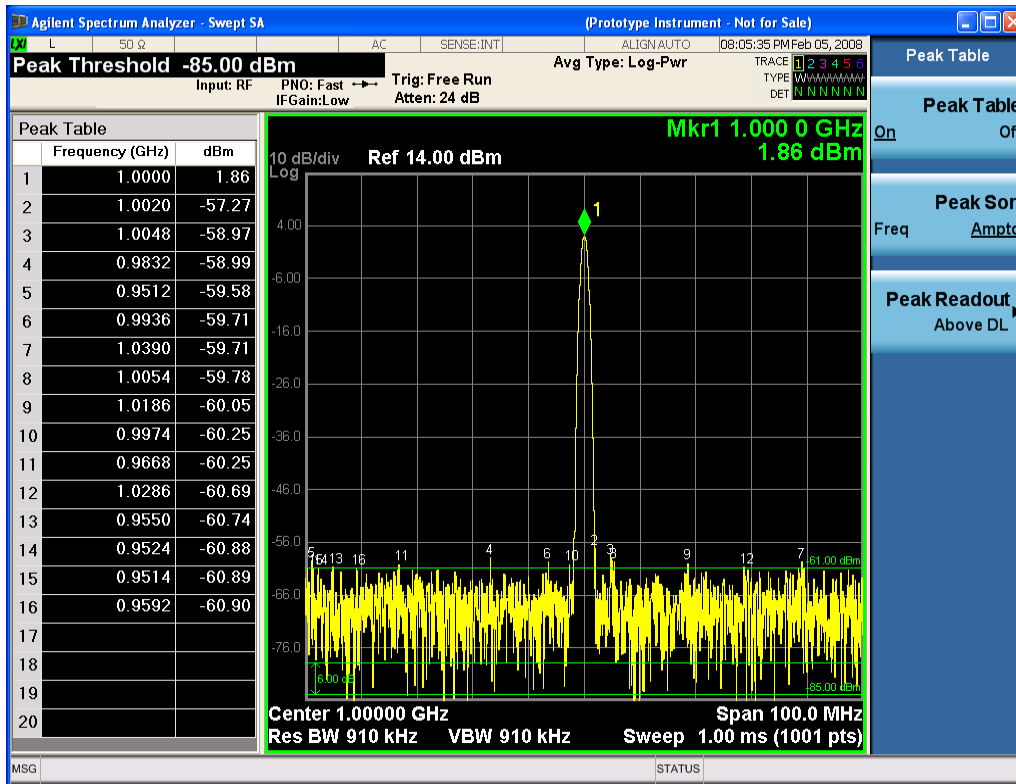

Then the Meas Results file, when opened, would show the header data (the same as for the Marker Table except that the Result Type is Peak Table) ending with a few fields of specific interest to Peak Table users:

- Peak Threshold
- Peak Threshold State (On|Off)
- Peak Excursion
- Peak Excursion State (On|Off)
- Display Line
- Peak Readout (All|AboveDL|BelowDL)
- Peak Sort (Freq|Amptd)

These fields are then followed by the data for the Peak Table itself.

Note that the label for the Frequency column changes to Time in 0 span.

Here is what the table for the above display looks like:

MeasurementResult	
Swept SA	
A.01.40_R0017	N9020A
526 B25 PFR P26 EA3	1

Result Type	Peak Table
Ref Level	0
Number of Points	1001
Sweep Time	0.066266667
Start Frequency	10000000
Stop Frequency	26500000000
Average Count	0
Average Type	LogPower(Video)
RBW	3000000
RBW Filter	Gaussian
RBW Filter BW	3dB
VBW	3000000
Sweep Type	Swept
X Axis Scale	Lin
PreAmp State	Off
PreAmp Band	Low
Trigger Source	Free
Trigger Level	1.2
Trigger Slope	Positive
Trigger Delay	1.00E-06
Phase Noise Optimization	Fast
Swept If Gain	Low
FFT If Gain	Autorange
RF Coupling	AC
FFT Width	411900
Ext Ref	10000000
Input	RF
RF Calibrator	Off
Attenuation	10
Ref Level Offset	0
External Gain	0
X Axis Units	Hz
Y Axis Units	dBm
Peak Threshold	-85
Peak Threshold State	On
Peak Excursion	6
Peak Excursion State	On

Display Line	-61	
Peak Readout	AboveDL	
Peak Sort	Amptd	
DATA		
Peak	Frequency	Amplitude
1	1.0000E+06	1.86
2	1.0020E+06	-57.27
3	1.0048E+06	-58.97
4	9.8320E+05	-58.99
5	9.5120E+05	-59.58
6	9.9360E+05	-59.71
7	1.0390E+06	-59.71
8	1.0054E+06	-59.78
9	1.1086E+06	-60.05
10	9.9740E+05	-60.25
11	9.6680E+05	-60.25
12	1.0286E+06	-60.69
13	9.5500E+05	-60.74
14	9.5240E+05	-60.88
15	9.5140E+05	-60.89
16	9.5920E+05	-60.90
17		
18		
19		
20		

Spectrogram

This section discusses the Spectrogram Results file format. The Spectrogram choice only appears if option EDP is licensed.

The Spectrogram results are the same as a Trace data export, except that instead of having just one trace's data, all 300 traces appear one after the other.

Each trace has its own data mark; the data for Spectrogram Trace 0 follows the row marked DATA, the data for Spectrogram Trace 1 follows the row marked DATA1, for Spectrogram Trace 2 follows the row marked DATA2, and so on.

Each DATA row has a timestamp in the second column (as of firmware revision A.11.01). So, for example, if Trace 0 had a relative start time of 1729.523 sec, then the first DATA row would look like this:

DATA,1729.523

And if Trace 13 had a relative start time of 100.45 sec, then the fourteenth data row would look like:

DATA13,100.453

To find the absolute time for the relative timestamps of each trace, the last row before the first DATA row gives the absolute start time of the Spectrogram, in the form YYYYMMDDHHMMSS

So, for example, if the absolute start time is 13:23:45:678 on January 30, 2012, this row would look like:

Start Time,20120130132345678

NOTE:

NOTE The resolution of the absolute time stored is 1 ms, which matches up with the fact that the fastest sweep time is also 1 ms. However, there is no specification for the absolute accuracy of the clock in the analyzer, nor is there any facility provided to allow the user to set this time to any particular degree of accuracy.

Traces that have not yet been filled in the Spectrogram display are empty; there is no DATA header for them. The file ends after the last non-empty trace.

Imagine that, at the point where a Spectrogram Meas Result is requested, the following screen is showing:



For the purpose of this example, we have set the Average/Hold Number to 10, thus we have only traces 0 thru 10. The Spectrogram was started at 02:28:08:700 pm on April 25, 2012 (that is, 700 ms after 2:28:08 pm), although the screen dump itself shows a different time, as it was taken ten minutes after the Spectrogram data. Trace 0 is showing a start time of 5.30 seconds, meaning 5.3 seconds after the Spectrogram started (trace 10 has a start time of 0, as it was the first trace taken but has now rolled up into the tenth trace slot).

The Meas Results file, when opened, shows the header data and ten traces of trace data. Below is an extract from the result file for the above display. Note the start time of 20120425142808700 showing in the last row before the first DATA row, and the relative time of 5.299231048 showing in the first DATA row:

Result Type	Spectrogram
MeasResult	
Swept SA	
A.11.00.01	N9020A
F03 F07 F13 F26 ALL ALV B1C B1X B25 B2X B40 BAB BBA CR3 CRP DP2 DRD EA3 EDP EMC EP1 ERC ESC ESP EXM FSA HBA K03 LFE MPB P03 P08 P13 P26 PFR RTL RTS S40 SB1 SEC SM1 UK6 YAS YAV	1
Segment	0
Number of Points	1001
Sweep Time	0.523333333
Start Frequency	5999984415
Stop Frequency	6000009415
Average Count	0
Average Type	LogPower(Video)
RBW	240
RBW Filter	Gaussian
RBW Filter BW	3dB
VBW	240
Sweep Type	Swept
X Axis Scale	Lin
PreAmp State	Off
PreAmp Band	Low
Trigger Source	Free
Trigger Level	1.2
Trigger Slope	Positive
Trigger Delay	0
Phase Noise Optimization	Wide
Swept If Gain	Low

Result Type	Spectrogram
FFT If Gain	Autorange
RF Coupling	AC
FFT Width	411900
Ext Ref	10000000
Input	RF
RF Calibrator	Off
Attenuation	14
Ref Level Offset	0
External Gain	0
Trace Type	Clearwrite
Detector	Normal
Trace Math	Off
Trace Math Oper1	Trace5
Trace Math Oper2	Trace6
Trace Math Offset	0
Trace Name	Trace1
X Axis Units	Hz
Y Axis Units	dBm
Start Time	20120425142808700
DATA	5.299231048
5999984415	-76.34749519
5999984440	-77.28097006
5999984465	-75.32317869
5999984490	-73.64417681
5999984515	-72.67154604

○
○
○

6000009315	-77.94423277
6000009340	-79.51829697
6000009365	-78.46108961
6000009390	-78.46108957
6000009415	-76.59570596
DATA2	4.708697055

5999984415	-80.98197882
5999984440	-80.98197879
5999984465	-75.83142132
5999984490	-74.02712079
5999984515	-73.57213005

o
o
o

6000009315	-75.9183103
6000009340	-79.53787488
6000009365	-78.82602191
6000009390	-78.82602188
6000009415	-76.37486709
DATA10	0
5999984415	-75.56751112
5999984440	-75.76485645
5999984465	-76.67718717
5999984490	-78.79238489
5999984515	-83.72680212

o
o
o

6000009315	-71.3942461
6000009340	-72.28308332
6000009365	-73.92684489
6000009390	-75.45548832
6000009415	-75.17904815

Capture Buffer

This function allows you to store captured data for reuse in demod measurements using 'Save/Recall' functionality for 'Capture Buffer'.(This function is enabled for 'Code Domain' and 'Modulation Accuracy' measurements ONLY)

'Capture Buffer' is saved and loaded as IQ Data with properties which show Sample Rate, Length, IF BW, etc.

Use-Case are as followings;

Use Capture Buffer to perform analysis of the same captured data using 'Code Domain' and 'Modulation Accuracy' measurements, or to playback previously saved captured data.

Key Path	Save, Data
Mode	CDMA2000
Example	MMEM:STOR:CAPT "MyCaptureData.bin" This stores the capture data in the file MyCaptureData.bin in the default directory.
Dependencies	Capture buffer functionality is only available for Code Domain and Modulation Accuracy measurement. In other measurements, this key is grayed out.
Initial S/W Revision	Prior to A.02.00

Save As . . .

When you press "Save As", the analyzer brings up a Windows dialog and a menu entitled "**Save As.**" This menu allows you to navigate to the various fields in the Windows dialog without using a keyboard or mouse. The Tab and Arrow keys can also be used for dialog navigation.

See "[To File . . .](#)" on page 2070 in Save, State for a full description of this dialog and menu.

The default path for saving files is:

For all of the Trace Data Files:

My Documents\`<mode name>`\data\traces

For all of the Limit Data Files:

My Documents\`<mode name>`\data\limits

For all of the Measurement Results Data Files:

My Documents\`<mode name>`\data\`<measurement name>`\results

For all of the Capture Buffer Data Files:

My Documents\`<mode name>`\data\captureBuffer

Key Path	Save, Data
Mode	All
Notes	The key location is mode-dependent and will vary. Brings up the Save As dialog for saving a <code><mode specific></code> Save Type. The save is performed immediately and does not wait until the measurement is complete.
Initial S/W Revision	Prior to A.02.00

Screen Image

Pressing Screen Image accesses a menu of functions that enable you to specify a format and location for the saved screen image. It brings up a menu that allows you to specify the color scheme of the Screen Image (Themes) or navigate to the Save As dialog to perform the actual save.

Screen Image files contain an exact representation of the analyzer display. They cannot be loaded back onto the analyzer, but they can be loaded into your PC for use in many popular applications.

The image to be saved is actually captured when the Save front panel key is pressed, and kept in temporary storage to be used if you ask for a Screen Image save. When the Screen Image key is pressed, a "thumbnail" of the captured image is displayed, as shown below:

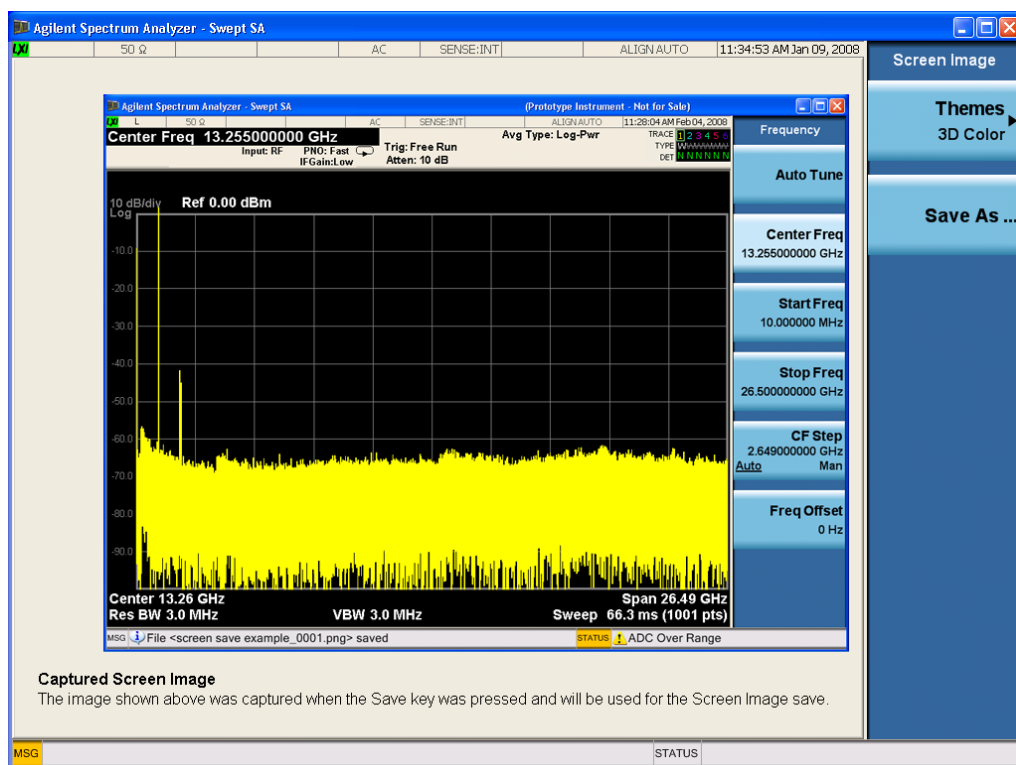

When you continue on into the Save As menu and complete the Screen Image save, the image depicted in the thumbnail is the one that gets saved, showing the menus that were on the screen before going into the Save menu. The save is performed immediately and does not wait until the measurement is complete.

After you have completed the save, the Quick Save front-panel key lets you quickly repeat the last save performed, using an auto-named file, with the current screen data.

NOTE

For versions previous to A.01.55, if you initiate a screen image save by navigating through the Save menus, the image that is saved will contain the Save menu softkeys, not the menus and the active function that were on the screen when you first pressed the Save front panel key.

Key Path	Save
Mode	All

Remote Command	:MMEMory:STORe:SCReen <filename>
Example	:MMEM:STOR:SCR "myScreen.png" This stores the current screen image in the file MyScreenFile.png in the default directory.
Initial S/W Revision	Prior to A.02.00

Themes

Accesses a menu of functions that enable you to choose the theme to be used when saving the screen image.

The **Themes** option is the same as the **Themes** option under the **Display** and **Page Setup** dialogs. It allows you to choose between themes to be used when saving the screen image.

Key Path	Save, Screen Image
Remote Command	:MMEMory:STORe:SCReen:THEME TDColor TDMonochrome FCOLOR FMONochrome :MMEMory:STORe:SCReen:THEMe?
Example	:MMEM:STOR:SCR:THEM TDM
Preset	3D Color; Is not part of Preset, but is reset by Restore Misc Defaults or Restore System Defaults All and survives subsequent running of the modes.
Readback	3D Color 3D Mono Flat Color Flat Mono
Backwards Compatibility Notes	In ESA and PSA we offer the choice of "Reverse Bitmap" or "Reverse Metafile" when saving screen images. This is much like the "Flat Color" theme available in X-Series. Also, if you selected Reverse Bitmap AND a black & white screen image, that would be much like "Flat Monochrome". In other words, each of the X-Series themes has a similar screen image type in ESA/PSA. But they are not identical.
Initial S/W Revision	Prior to A.02.00

3D Color

Selects a standard color theme with each object filled, shaded and colored as designed.

Key Path	Save, Screen Image, Themes
Example	MMEM:STOR:SCR:THEM TDC
Readback	3D Color
Initial S/W Revision	Prior to A.02.00

3D Monochrome

Selects a format that is like 3D color but shades of gray are used instead of colors.

Key Path	Save, Screen Image, Themes
Example	MMEM:STOR:SCR:THEM TDM
Readback	3D Mono
Initial S/W Revision	Prior to A.02.00

Flat Color

Selects a format that is best when the screen is to be printed on an ink printer.

Key Path	Save, Screen Image, Themes
Example	MMEM:STOR:SCR:THEM FCOL
Readback	Flat Color
Initial S/W Revision	Prior to A.02.00

Flat Monochrome

Selects a format that is like Flat Color. But only black is used (no colors, not even gray), and no fill.

Key Path	Save, Screen Image, Themes
Example	MMEM:STOR:SCR:THEM FMON
Readback	Flat Mono
Initial S/W Revision	Prior to A.02.00

Save As...

When you press "Save As", the analyzer brings up a Windows dialog and a menu entitled "**Save As.**" This menu allows you to navigate to the various fields in the Windows dialog without using a keyboard or mouse. The Tab and Arrow keys can also be used for dialog navigation.

See "[To File . . .](#)" on page 2070 in Save, State for a full description of this dialog and menu.

The default path for Screen Images is

My Documents\`<mode name>`\screen.

where `<mode name>` is the parameter used to select the mode with the INST:SEL command (for example, SA for the Spectrum Analyzer).

Key Path	Save, Screen Image
Notes	Brings up Save As dialog for saving a Screen Image Save Type
Initial S/W Revision	Prior to A.02.00

Single (Single Measurement/Sweep)

Sets the analyzer for Single measurement operation. The single/continuous state is Meas Global, so the setting will affect all the measurements. If you are Paused, pressing Single does a Resume.

See ["More Information" on page 1847](#)

Key Path	Front-panel key
Example	:INIT:CONT OFF
Notes	See Cont key description.
Backwards Compatibility Notes	<p>For Spectrum Analysis mode in ESA and PSA, the Single hardkey and the INITiate:IMM switched from continuous measurement to single measurement and restarted sweeps and averages (displayed average count reset to 1), but did not restart Max Hold and Min Hold. In the X-Series, the Single hardkey and the INITiate:IMM command initiate a sweep/ measurement/ average sequence/hold sequence including MaxHold and MinHold.</p> <p>For Spectrum Analysis mode in ESA and PSA, the Single hardkey restarted the sweep regardless of whether or not you were in an active sweep or sweep sequence. In the X-Series, Restart does this but Single only restarts the sweep or sweep sequence if you are in the idle state.</p> <p>INIT[:IMM] in ESA & PSA Spectrum Analysis Mode does an implied ABORt. In some other PSA Modes, INIT[:IMM] is ignored if not in the idle state. . The X-Series follows the ESA/PSA SA Mode model, which may cause some Modes to have compatibility problems.</p>
Initial S/W Revision	Prior to A.02.00

More Information

See ["Restart" on page 2067](#) for details on the INIT:IMMEDIATE (Restart) function.

If you are already in single sweep, the INIT:CONT OFF command has no effect.

If you are already in Single Sweep, then pressing the Single key in the middle of a sweep does not restart the sweep or sequence. Similarly, pressing the Single key does not restart the sweep or sequence if the sweep is not in the idle state (for example, if you are taking a very slow sweep, or the analyzer is waiting for a trigger). Instead, it results in a message. "Already in Single, press Restart to initiate a new sweep or sequence". Even though pressing the Single key in the middle of a sweep does not restart the sweep, sending INIT:IMMEDIATE does reset it.

To take one more sweep without resetting the average count, increment the average count by 1, by pressing the step up key while **Average/Hold Number** is the active function, or sending the remote command CALC:AVER:TCON UP.

Source

Opens a menu of keys that access various source configuration menus and settings. In the test set, pressing this key also causes the central view area to change and display the Source Control Main view.

Key Path	Front-panel key
----------	-----------------

RF Output

This parameter sets the source RF power output state.

Key Path	Source
Remote Command	:OUTPut[:EXTErnal][:STATe] ON OFF 1 0 :OUTPut[:EXTErnal][:STATe]?
Example	OUTP OFF OUTP?
Notes	<p>The EXTErnal node is shown in RD text so the SCPI remains the same between internal and external source control. However, for EXT we do not wish to document this node to the customer since we are controlling the internal source rather than the external source.</p> <p>This setting is for the independent mode and has no effect on the "List Sequencer" on page 2168. If the "Sequencer" on page 2168 is set to ON, the list sequencer controls the source output and this key will be grayed-out. And this setting will be none-forceful grey out on front panel to indicate out-of-scope. Non-forceful means user still can change this setting by SCPI but cannot change on front panel. When set to OFF will make source leave list sequencer and this setting will be black out and take effect immediately.</p> <p>When the RF Output is ON, an "RF" annunciator is displayed in the system settings panel. When the RF Output is turned Off, the RF annunciator is cleared. If the "Sequencer" on page 2168 is set to ON, the "RF" annunciator will be replaced by "SEQ" in the system settings panel, indicating that the output is controlled by the list sequencer.</p>
Preset	Off
Range	On Off
Initial S/W Revision	A.05.00

Amplitude

Allows you to access the Amplitude sub-menu.

Key Path	Source
Notes	<p>The sub-menu under this button is for independent mode and has no effect on "List Sequencer" on page 2168. If the "Sequencer" on page 2168 is set to ON, the list sequencer controls the source output and this key will be grayed-out on front panel to indicate out-of-scope. When you set "Sequencer" on page 2168 to Off will make source leave list sequencer and this button will be black out.</p>
Initial S/W Revision	A.05.00

RF Power

Allows you to adjust the power level of the source using the numeric keypad, step keys, or RPG. Pressing any digit, 0 through 9, on the numeric keypad brings up the unit terminator.

Please refer to the "RF Power Range " on page 1850 table below for the valid ranges.

Key Path	Source, Amplitude
Remote Command	:SOURce:POWer[:LEVel][:IMMediate][:AMPLitude] <ampl> :SOURce:POWer[:LEVel][:IMMediate][:AMPLitude]?
Example	:SOUR:POW -100 dBm
Notes	<p>Amplitude corrections can be specified for use with the source. In the event of amplitude corrections being applied, the valid ranges for the RF power do not change dependant on the current amplitude correction setting. If the combination of RF power + amplitude correction is higher or lower than the source output range, the Source Unleveled bit is set and the "Source Unleveled" indicator will appear on status panel to indicate that the source cannot maintain the output power that has been requested.</p> <p>When signal generator is unable to maintain the requested output level, the "Source Unleveled" indicator will appear on status panel. When the source output setting is restored to the normal range, the "Source Unleveled" is removed from status panel.</p> <p>Internal source has list sequence mode, which comprises of several steps which contain separate output power, frequency and waveform etc. When the source list sequence playing is complete, the last step keeps playing, and user can use this command to change the list sequence last step's output power.</p> <p>The multiport adapter RFIO TX ports and GPS ports cannot ensure power accuracy when power setting is lower than -130dBm, this power setting value is defined by the sum of RF Power setting and related amplitude correction value. But user settable value could be lower than this limit. When application detected there exists power setting lower than -130dBm on MPA RFIO TX ports, then popup warning message . When application detected there exists power setting lower than -130dBm on MPA GPS ports, then popup warning message . This is only warning message, and check is performed when RF is ON.</p>
Notes	The Min and Max value here defined UI settable amplitude range. This range is larger than actual amplitude range with level accuracy defined in spec.
Dependencies	The RF power is dependent on the RF output port and frequency, such that the current frequency and selected output port determine the valid range of power values.
Preset	-100 dBm
Min	The range of values depends on the current frequency and selected RF output port. Please refer to the "RF Power Range " on page 1850 table below for the valid ranges.
Max	The range of values depends on the current frequency and selected RF output port. Please refer to the "RF Power Range " on page 1850 table below for the valid ranges.
Initial S/W Revision	A.05.00

All other models:

RF Power Range

RF Output Port	Frequency Range	Min Output Power	Max Output Power
High Power RF Out	10 MHz ≤ f ≤ 6 GHz	-150 dBm	20 dBm
RFIO 1 & RFIO 2	10 MHz ≤ f ≤ 6 GHz	-150 dBm	0 dBm
GPS (Note2)	10 MHz ≤ f ≤ 6 GHz	-150 dBm	0 dBm

Note: This is the UI power range, it's larger than actual spec.

Note2: GPS port is on the multiport adapter, or E6607C which has embedded MPA.

M9420A:

RF Power Range

RF Output Port	Frequency Range	Min Output Power	Max Output Power without Option "1EA"	Max Output Power with Option "1EA"
RF Output	60 MHz ≤ f ≤ 6 GHz	-150 dBm	10 dBm	18 dBm
RFHD	60 MHz ≤ f ≤ 6 GHz	-150 dBm	10 dBm	15 dBm
RFFD	60 MHz ≤ f ≤ 6 GHz	-150 dBm	0 dBm	0 dBm

Set Reference Power

This key allows you to set the power reference. Pressing this key turns the power reference state to ON, sets the reference power value to the current RF output power, maintains this power at the RF output, and sets the displayed power to 0.00 dB. All subsequent RF power values entered under Source>Amplitude>RF Power are interpreted as being relative to this reference power.

When you use a power reference, the signal generator outputs an RF power that is set relative to the reference power by the value entered under Source>Amplitude>RF Power as follows:

Output power = reference power – entered power

Where:

reference power equals the original RF Power entered under Source>Amplitude>RF Power and set as the reference power

entered power equals a new value entered under Source>Amplitude>Amptd Offset

In addition, the displayed power value is the same as a new value entered under Source>Amplitude>RF Power.

NOTE

If Power Ref is set to ON with a reference value set, entering a value under Source>Amplitude>RF Power and pressing Set Reference Power will add that value to the existing Power Ref value.

If you wish to change the reference power value to a new value entered under Source>Amplitude>RF Power, first you must set Power Ref to OFF and then press Set Reference Power.

Key Path	Source, Amplitude
Dependencies	This key is unavailable, and is grayed out when the "List Sequencer" on page 2168 is turned ON.
Initial S/W Revision	A.05.00

Power Ref

This key allows you to toggle the state of the power reference.

When you use a power reference, the signal generator outputs an RF power that is set relative to the reference power by the value entered under Source>Amplitude>RF Power as follows:

Output power = reference power + entered power

Where:

reference power equals the original RF Power entered under Source>Amplitude>RF Power and set as the reference power

entered power equals a new value entered under Source>Amplitude>Amptd Offset

For more information on Reference Frequency refer to ["Set Reference Power " on page 2099](#)

Key Path	Source, Amplitude
Remote Command	:SOURce:POWer:REFeRence <ampl> :SOURce:POWer:REFeRence? :SOURce:POWer:REFeRence:STATe OFF ON 0 1 :SOURce:POWer:REFeRence:STATe?
Example	:SOUR:POW:REF 0.00 dBm :SOUR:POW:REF:STATe ON
Dependencies	This setting is unavailable and is grayed out when the "List Sequencer" on page 2168 is turned ON.
Couplings	This value is coupled to the "Set Reference Power " on page 2099 key such that pressing the Set Reference Power key updates the reference power with the current output power.
Preset	0.00 dBm OFF
Min	-125.00 dBm
Max	10.00 dBm
Initial S/W Revision	A.05.00

Amptd Offset

Allows you to specify the RF output power offset value.

When the amplitude offset is set to zero (0) and you set a new offset value (positive or negative), the displayed amplitude value will change as follows and the RF output power will not change:

Displayed value = output power + offset value

Where:

output power equals the original RF Power entered under Source>Amplitude>RF Power

offset value equals the value entered under Source>Amplitude>Amptd Offset

When the amplitude offset is set to a value other than zero (0) and you enter a new RF power value under Source>Amplitude>RF Power, the displayed power will be the same as the value entered and the RF output power will be equal to the value entered minus the offset value as follows:

Output power = entered power – offset power

Displayed Power = output power + offset power

Displayed power = entered power

Where:

entered power equals the amplitude entered under Source>Amplitude>RF Power

offset power equals the value previously entered and set under Source>Amplitude>Amptd Offset

Key Path	Source, Amplitude
Remote Command	:SOURce:POWer[:LEVel][:IMMediate]:OFFSet <rel_ampl> :SOURce:POWer[:LEVel][:IMMediate]:OFFSet?
Example	:SOUR:POW:OFFS 0.00 dB
Dependencies	This setting is unavailable, and is grayed out when the List Sequencer is turned ON.
Preset	0.00 dB
Min	-200.00 dB
Max	200.00 dB
Initial S/W Revision	A.05.00

Modulation

Allows you to toggle the state of the modulation.

Key Path	Source
Remote Command	:OUTPut:MODulation[:STATe] ON OFF 1 0 :OUTPut:MODulation[:STATe]?
Example	:OUTP:MOD OFF
Notes	This setting is for independent mode and has no effect on "List Sequencer" on page 2168 . If the "Sequencer" on page 2168 is set to ON, the list sequencer controls the source output and this key will be grayed-out. And this setting will be none-forceful grey out on front panel to indicate out-of-scope. Non-forceful means user still can change this setting by SCPI but cannot change manually on front panel. When set to Off will make source leave list sequencer and this setting will be black out and take effect immediately. When the Modulation is ON, the "MOD" annunciator is displayed in the system settings panel. When the Modulation is turned Off, the "MOD" annunciator is cleared. If the

"Sequencer" on page 2168 is set to ON, the "MOD" annunciator will be replaced by "SEQ" in the system settings panel indicating that the output is controlled by list sequencer.

Preset	Off
Range	On Off
Initial S/W Revision	A.05.00

Frequency

Allows you to access the Frequency sub-menu.

Key Path	Source
Notes	The sub-menu under this button is for independent mode and has no effect on "List Sequencer" on page 2168. If the "Sequencer" on page 2168 is set to ON, the list sequencer controls the source output and this key will be grayed-out. And this button will be grey out on front panel to indicate out-of-scope. When set to Off will make source leave list sequencer and this button will be black out.
Initial S/W Revision	A.05.00

Frequency

Allows you to set the RF Output Frequency. You can adjust the frequency of the source using the numeric keypad, step keys, or RPG. Pressing any digit, 0 through 9, on the numeric keypad brings up the unit terminator.

Key Path	Source, Frequency
Remote Command	:SOURce:FREQuency[:CW] <freq> :SOURce:FREQuency[:CW]?
Example	:SOUR:FREQ 1.00 GHz
Notes	Internal source has list sequence mode, which comprises of several steps which contain separate output power, frequency and waveform etc. When the source list sequence playing is complete, the last step keeps playing, and user can use this command to change the list sequence last step's output frequency.
Couplings	The frequency value is coupled to the current channel band and number, such that updates to the band and number will update the frequency value to the corresponding absolute frequency.
Preset	1.00 GHz If license F1A or 5WC is present, the default Center Frequency should be 2.412GHz.
Min	10.00 MHz
Max	Hardware Dependant: Option 503 = 3.6 GHz Option 504 = 3.8 GHz Option 506 = 6.00 GHz For E6640A, if license 5WC is present, the frequency range should be limited to: 1.1GHz-1.7GHz,

2.4GHz–2.5GHz, 4.8GHz–6.0GHz. If the user-defined frequency is outside of range, UI will report an error message called “Settings conflict; Frequency is outside available range”.

Initial S/W Revision A.05.00

Channel

The frequency of the source can be specified by a channel number of a given frequency band. This key allows you to specify the current channel number. For the appropriate range of channel numbers for a given frequency band, refer to the following tables: ["GSM/EDGE Channel Number Ranges" on page 1854](#), ["W-CDMA Channel Number Ranges" on page 1855](#), ["CDMA 2000 / 1xEVDO Channel Number Ranges" on page 1857](#), and ["LTE FDD Channel Number Ranges" on page 1859](#).

Key Path	Source, Frequency
Remote Command	:SOURCE:FREQUENCY:CHANNELS:NUMBER <int> :SOURCE:FREQUENCY:CHANNELS:NUMBER?
Example	:SOUR:FREQ:CHAN:NUMB 1
Notes	This key is grayed out when the "Radio Standard" on page 2111 is set to NONE. This key is grayed out on E6630A.
Dependencies	This key is grayed out when the "Radio Standard" on page 2111 is set to NONE. This key is grayed out on E6630A.
Couplings	The channel number is coupled to the frequency value when the "Radio Standard" on page 2111 is not set to NONE. When the frequency value is changed, the channel number will increase or decrease to match the new frequency. If the frequency is not at an exact match for a channel number, the nearest channel number is displayed along with a greater than or less than sign to indicate the frequency is above or below the channel number.
Preset	1
Min	Please refer to the tables below for the valid ranges.
Max	Please refer to the tables below for the valid ranges.
Initial S/W Revision	A.05.00

GSM/EDGE Channel Number Ranges

Band	Link (Device)	Range	Frequency (MHz)
P-GSM	Uplink (MS)	$1 \leq n \leq 124$	$890.0 + 0.2*n$
	Downlink (BS)	$1 \leq n \leq 124$	$935.0 + 0.2*n$
E-GSM	Uplink (MS)	$0 \leq n \leq 124$	$890.0 + 0.2*n$
		$975 \leq n \leq 1023$	$890.0 + 0.2*(n-1024)$
	Downlink (BS)	$0 \leq n \leq 124$	$935.0 + 0.2*n$
		$975 \leq n \leq 1023$	$935.0 + 0.2*(n-1024)$

Band	Link (Device)	Range	Frequency (MHz)
DCS 1800	Uplink (MS)	$512 \leq n \leq 885$	$1710.200 + 0.20*(n-512)$
	Downlink (BS)	$512 \leq n \leq 885$	$1805.200 + 0.20*(n-512)$
PCS 1900	Uplink (MS)	$512 \leq n \leq 810$	$1850.200 + 0.2*(n-512)$
	Downlink (BS)	$512 \leq n \leq 810$	$1930.200 + 0.2*(n-512)$
R-GSM	Uplink (MS)	$0 \leq n \leq 124$	$890.0 + 0.2*n$
		$955 \leq n \leq 1023$	$890.0 + 0.2*(n-1024)$
	Downlink (BS)	$0 \leq n \leq 124$	$935.0 + 0.2*n$
		$955 \leq n \leq 1023$	$935.0 + 0.2*(n-1024)$
GSM 450	Uplink (MS)	$256 \leq n \leq 293$	$450.6 + 0.2*(n-259)$
	Downlink (BS)	$256 \leq n \leq 293$	$460.6 + 0.2*(n-259)$
GSM 480	Uplink (MS)	$306 \leq n \leq 340$	$479.000 + 0.20*(n-306)$
	Downlink (BS)	$306 \leq n \leq 340$	$489.000 + 0.20*(n-306)$
GSM 850	Uplink (MS)	$128 \leq n \leq 251$	$824.200 + 0.20*(n-128)$
	Downlink (BS)	$128 \leq n \leq 251$	$869.200 + 0.20*(n-128)$
GSM 700	Uplink (MS)	$438 \leq n \leq 516$	$777.200 + 0.20*(n-438)$
	Downlink (BS)	$438 \leq n \leq 516$	$747.200 + 0.20*(n-438)$
T-GSM810	Uplink (MS)	$350 \leq n \leq 425$	$806.0 + 0.20*(n-350)$
	Downlink (BS)	$350 \leq n \leq 425$	$851.0 + 0.20*(n-350)$

W-CDMA Channel Number Ranges

Band	Link (Device)	Range	Frequency (MHz)
Band I	Downlink	$10562 \leq n \leq 10838$	$n \div 5$
	Uplink	$9612 \leq n \leq 9888$	$n \div 5$
Band II	Downlink	$412 \leq n \leq 687$	$n \div 5 + 1850.1$
		$9662 \leq n \leq 9938$	$n \div 5$
	Uplink	$12 \leq n \leq 287$	$n \div 5 + 1850.1$
		$350 \leq n \leq 425$	$n \div 5$
Band III	Downlink	$1162 \leq n \leq 1513$	$n \div 5 + 1575$
	Uplink	$937 \leq n \leq 1288$	$n \div 5 + 1525$
Band IV	Downlink	$537 \leq n \leq 1738$	$n \div 5 + 1805$
		$1887 \leq n \leq 2087$	$n \div 5 + 1735.1$
	Uplink	$1312 \leq n \leq 1513$	$n \div 5 + 1450$
		$1662 \leq n \leq 1862$	$n \div 5 + 1380.1$
Band V	Downlink	$1007 \leq n \leq 1087$	$n \div 5 + 670.1$
		$4357 \leq n \leq 4458$	$n \div 5$

Band	Link (Device)	Range	Frequency (MHz)
	Uplink	$782 \leq n \leq 862$	$n \div 5 + 670.1$
		$4132 \leq n \leq 4233$	$n \div 5$
Band VI	Downlink	$1037 \leq n \leq 1062$	$n \div 5 + 670.1$
		$4387 \leq n \leq 4413$	$n \div 5$
	Uplink	$812 \leq n \leq 837$	$n \div 5 + 670.1$
		$4162 \leq n \leq 4188$	$n \div 5$
Band VII	Downlink	$2237 \leq n \leq 2563$	$n \div 5 + 2175$
		$2587 \leq n \leq 2912$	$n \div 5 + 2105.1$
	Uplink	$2012 \leq n \leq 2338$	$n \div 5 + 2100$
		$2362 \leq n \leq 2687$	$n \div 5 + 2030.1$
Band VIII	Downlink	$2937 \leq n \leq 3088$	$n \div 5 + 340$
	Uplink	$2712 \leq n \leq 2863$	$n \div 5 + 340$
Band IX	Downlink	$9237 \leq n \leq 9387$	$n \div 5$
	Uplink	$8762 \leq n \leq 8912$	$n \div 5$
Band X	Downlink	$3112 \leq n \leq 3388$	$n \div 5 + 1490$
		$3412 \leq n \leq 3687$	$n \div 5 + 1430.1$
	Uplink	$2887 \leq n \leq 3163$	$n \div 5 + 1135$
		$3187 \leq n \leq 3462$	$n \div 5 + 1075.1$
Band XI	Downlink	$3712 \leq n \leq 3812$	$n \div 5 + 736$
	Uplink	$3487 \leq n \leq 3587$	$n \div 5 + 733$
Band XII	Downlink	$3837 \leq n \leq 3903$	$n \div 5 - 37$
		$3927 \leq n \leq 3992$	$n \div 5 - 54.9$
	Uplink	$3612 \leq n \leq 3678$	$n \div 5 - 22$
		$3702 \leq n \leq 3767$	$n \div 5 - 39.9$
Band XIII	Downlink	$4017 \leq n \leq 4043$	$n \div 5 - 55$
		$4067 \leq n \leq 4092$	$n \div 5 - 64.9$
	Uplink	$3792 \leq n \leq 3818$	$n \div 5 + 21$
		$3702 \leq n \leq 3767$	$n \div 5 - 39.9$
Band XIV	Downlink	$4117 \leq n \leq 4143$	$n \div 5 - 63$
		$4167 \leq n \leq 4192$	$n \div 5 - 72.9$
	Uplink	$3892 \leq n \leq 3918$	$n \div 5 + 12$
		$3942 \leq n \leq 3967$	$n \div 5 + 2.1$
Band XIX	Downlink	$712 \leq n \leq 763$	$n \div 5 + 735$
		$787 \leq n \leq 837$	$n \div 5 + 720.1$
	Uplink	$312 \leq n \leq 363$	$n \div 5 + 770$
		$387 \leq n \leq 437$	$n \div 5 + 755.1$

CDMA 2000 / 1xEVDO Channel Number Ranges

Band	Link (Device)	Range	Frequency (MHz)
US Cellular	Uplink (MS, reverse link)	$1 \leq N \leq 799$	$0.030 \times N + 825.000$
		$991 \leq N \leq 1023$	$0.030 \times (N - 1023) + 825.000$
		$1024 \leq N \leq 1323$	$0.030 \times (N - 1024) + 815.040$
	Downlink (BS, forward link)	$1 \leq N \leq 799$	$0.030 \times N + 870.000$
		$991 \leq N \leq 1023$	$0.030 \times (N - 1023) + 870.000$
		$1024 \leq N \leq 1323$	$0.030 \times (N - 1024) + 860.040$
US PCS	Uplink (MS, reverse link)	$0 \leq N \leq 1199$	$1850.000 + 0.050 \times N$
	Downlink (BS, forward link)	$0 \leq N \leq 1199$	$1930.000 + 0.050 \times N$
Japan Cellular Band	Uplink (MS, reverse link)	$1 \leq N \leq 799$	$0.0125 \times (N + 915.000)$
		$801 \leq N \leq 1039$	$0.0125 \times (N - 800) + 898.000$
		$1041 \leq N \leq 1199$	$0.0125 \times (N - 1040) + 887.000$
		$1201 \leq N \leq 1600$	$0.0125 \times (N - 1200) + 893.000$
	Downlink (BS, forward link)	$1 \leq N \leq 799$	$0.0125 \times (N + 860.000)$
		$801 \leq N \leq 1039$	$0.0125 \times (N - 800) + 843.000$
		$1041 \leq N \leq 1199$	$0.0125 \times (N - 1040) + 832.000$
		$1201 \leq N \leq 1600$	$0.0125 \times (N - 1200) + 838.000$
Korean PCS Band	Uplink (MS, reverse link)	$0 \leq N \leq 599$	$0.050 \times N + 1750.000$
	Downlink (BS, forward link)	$0 \leq N \leq 599$	$0.050 \times N + 1840.000$
NMT-450 Band	Uplink (MS, reverse link)	$1 \leq N \leq 400$	$0.025 \times (N - 1) + 450.000$
		$472 \leq N \leq 871$	$0.025 \times (N - 472) + 410.000$
		$1039 \leq N \leq 1473$	$0.020 \times (N - 1024) + 451.010$
		$1536 \leq N \leq 1715$	$0.025 \times (N - 1536) + 479.000$
		$1792 \leq N \leq 2016$	$0.020 \times (N - 1792) + 479.000$
	Downlink (BS, forward link)	$1 \leq N \leq 400$	$0.025 \times (N - 1) + 460.000$
		$472 \leq N \leq 871$	$0.025 \times (N - 472) + 420.000$
		$1039 \leq N \leq 1473$	$0.020 \times (N - 1024) + 461.010$
IMT-2000 Band	Uplink (MS, reverse link)	$0 \leq N \leq 1199$	$1920.000 + 0.050 \times N$
	Downlink (BS, forward link)	$0 \leq N \leq 1199$	$2100.000 + 0.050 \times N$
Upper 700 MHz Band	Uplink (MS, reverse link)	$0 \leq N \leq 240$	$776.000 + 0.050 \times N$
	Downlink (BS, forward link)	$0 \leq N \leq 240$	$746.000 + 0.050 \times N$

Band	Link (Device)	Range	Frequency (MHz)
	forward link)		
Secondary 800 MHz Band	Uplink (MS, reverse link)	$0 \leq N \leq 719$	$0.025 \times N + 806.000$
		$720 \leq N \leq 919$	$0.025 \times (N - 720) + 896.000$
	Downlink (BS, forward link)	$0 \leq N \leq 719$	$0.025 \times N + 851.000$
		$720 \leq N \leq 919$	$0.025 \times (N - 720) + 935.000$
2.5 GHz IMT Extension	Uplink (MS, reverse link)	$0 \leq N \leq 1399$	$2500.000 + 0.050 \times N$
	Downlink (BS, forward link)	$0 \leq N \leq 1399$	$2620.000 + 0.050 \times N$
US PCS 1.9 GHz	Uplink (MS, reverse link)	$0 \leq N \leq 1299$	$1850.000 + 0.050 \times N$
	Downlink (BS, forward link)	$0 \leq N \leq 1299$	$1930.000 + 0.050 \times N$
AWS	Uplink (MS, reverse link)	$0 \leq N \leq 899$	$1710.000 + 0.050 \times N$
	Downlink (BS, forward link)	$0 \leq N \leq 899$	$2100.000 + 0.050 \times N$
US 2.5 GHz	Uplink (MS, reverse link)	$140 \leq N \leq 1459$	$2495.000 + 0.050 \times N$
	Downlink (BS, forward link)	$140 \leq N \leq 1459$	$2617.000 + 0.050 \times N$
700 Public Safety	Uplink (MS, reverse link)	$0 \leq N \leq 240$	$787.000 + 0.050 \times N$
	Downlink (BS, forward link)	$0 \leq N \leq 240$	$757.000 + 0.050 \times N$
C2K Lower 700	Uplink (MS, reverse link)	$0 \leq N \leq 360$	$698.000 + 0.050 \times N$
	Downlink (BS, forward link)	$0 \leq N \leq 360$	$728.000 + 0.050 \times N$
400 Euro PAMR	Uplink (MS, reverse link)	$1 \leq N \leq 400$	$0.025 \times (N - 1) + 450.000$
		$472 \leq N \leq 871$	$0.025 \times (N - 472) + 410.000$
	Uplink (MS, reverse link)	$1536 \leq N \leq 1715$	$0.025 \times (N - 1536) + 479.000$
	Uplink (MS, reverse link)		
	Downlink (BS, forward link)	$1 \leq N \leq 400$	$0.025 \times (N - 1) + 460.000$
		$472 \leq N \leq 871$	$0.025 \times (N - 472) + 420.000$
	Downlink (BS, forward link)	$1536 \leq N \leq 1715$	$0.025 \times (N - 1536) + 489.000$
	Downlink (BS, forward link)		

Band	Link (Device)	Range	Frequency (MHz)
800 PAMR	Uplink (MS, reverse link)	$0 \leq N \leq 239$	$870.0125 + 0.025 \times N$
	Downlink (BS, forward link)	$0 \leq N \leq 239$	$915.0125 + 0.025 \times N$

LTE FDD Channel Number Ranges

The carrier frequency in the uplink and downlink is designated by the E-UTRA Absolute Radio Frequency Channel Number (EARFCN) in the range 0 – 65535. The relation between EARFCN and the carrier frequency in MHz for the downlink is given by the following equation, where FDL_low and NOffs-DL are given in table 5.4.4-1 and NDL is the downlink EARFCN.

$$FDL = FDL_low + 0.1(NDL - NOffs-DL)$$

The relation between EARFCN and the carrier frequency in MHz for the uplink is given by the following equation where FUL_low and NOffs-UL are given in table 5.4.4-1 and NUL is the uplink EARFCN.

$$FUL = FUL_low + 0.1(NUL - NOffs-UL)$$

Band	Downlink		Uplink			
	FDL_low (MHz)	NOffs-DL	Range of NDL	FUL_low (MHz)	NOffs-UL	Range of NUL
1		2110	0	0 - 599	1920	18000 - 18599
2		1930	600	600 - 1199	1850	18600 - 19199
3		1805	1200	1200 - 1949	1710	19200 - 19949
4		2110	1950	1950 - 2399	1710	19950 - 20399
5		869	2400	2400 - 2649	824	20400 - 20649
6		875	2650	2650 - 2749	830	20650 - 20749
7		2620	2750	2750 - 3449	2500	20750 - 20449
8		925	3450	3450 - 3799	880	21450 - 21799
9		1844.9	3800	3800 - 4149	1749.9	21800 - 22149
10		2110	4150	4150 - 4749	1710	22150 - 22749
11		1475.9	4750	4750 - 4949	1427.9	22750 - 22949

Band	Downlink	Uplink				
12	729	5010	5010 - 5179	699	23010	23010 - 23179
13	746	5180	5180 - 5279	777	23180	23180 - 23279
14	758	5280	5280 - 5379	788	23280	23280 - 23379
...						
17	734	5730	5730 - 5849	704	23730	23730 - 23849
18	860	5850	5850 - 5999	815	23850	23850 - 23999
19	875	6000	6000 - 6149	830	24000	24000 - 24149
20	791	6150	6150 - 6449	832	24150	24150 - 24449
21	1495.9	6450	6450 - 6599	1447.9	24450	24450 - 24599
...						
24	1525	7700	7700 - 8039	1626.5	25700	25700 - 26039
25	1930	8040	8040 - 8689	1850	26040	26040 - 26689
26	859	8690	8690 - 9039	814	26690	26690 - 27039
...						

Note: The channel numbers that designate carrier frequencies so close to the operating band edges that the carrier extends beyond the operating band edge shall not be used. This implies that the first 7, 15, 25, 50, 75 and 100 channel numbers at the lower operating band edge and the last 6, 14, 24, 49, 74 and 99 channel numbers at the upper operating band edge shall not be used for channel bandwidths of 1.4, 3, 5, 10, 15 and 20 MHz respectively.

LTE TDD Channel Number Ranges

The carrier frequency in the uplink and downlink is designated by the E-UTRA Absolute Radio Frequency Channel Number (EARFCN) in the range 0 – 65535. The relation between EARFCN and the carrier frequency in MHz for the downlink is given by the following equation, where FDL_low and NOffs-DL are given in table 5.4.4-1 and NDL is the downlink EARFCN.

$$FDL = FDL_low + 0.1(NDL - NOffs-DL)$$

The relation between EARFCN and the carrier frequency in MHz for the uplink is given by the following equation where FUL_low and NOffs-UL are given in table 5.4.4-1 and NUL is the uplink EARFCN.

$$FUL = FUL_low + 0.1(NUL - NOffs-UL)$$

Band	Downlink		Uplink		
	NOffs-DL	Range of ND	FUL_low (MHz)	NOffs-UL	Range of NUL
33	1900	36000	36000 - 36199	1900	36000 - 36199
34	2010	36200	36200 - 36349	2010	36200 - 36349
35	1850	36350	36350 - 36949	1850	36350 - 36949
36	1930	36950	36950 - 37549	1930	36950 - 37549
37	1910	37550	37550 - 37749	1910	37550 - 37749
38	2570	37750	37750 - 38249	2570	37750 - 38249
39	1880	38250	38250 - 38649	1880	38250 - 38649
40	2300	38650	38650 - 39649	2300	38650 - 39649
41	2496	39650	39650 - 41589	2496	39650 - 41589
42	3400	41590	41590 - 43589	3400	41590 - 43589
43	3600	43590	43590 - 45589	3600	43590 - 45589

Note: The channel numbers that designate carrier frequencies so close to the operating band edges that the carrier extends beyond the operating band edge shall not be used. This implies that the first 7, 15, 25, 50, 75 and 100 channel numbers at the lower operating band edge and the last 6, 14, 24, 49, 74 and 99 channel numbers at the upper operating band edge shall not be used for channel bandwidths of 1.4, 3, 5, 10, 15 and 20 MHz respectively.

TDSCDMA Channel Number Ranges

1.28 Mcps TDD Option

No TX-RX frequency separation is required as Time Division Duplex (TDD) is employed. Each subframe consists of 7 main timeslots where all main timeslots (at least the first one) before the single switching point are allocated DL and all main timeslots (at least the last one) after the single switching point are allocated UL.

The nominal channel spacing is 1.6 MHz, but this can be adjusted to optimise performance in a particular deployment scenario.

The carrier frequency is designated by the UTRA absolute radio frequency channel number (UARFCN). The value of the UARFCN in the IMT2000 band is defined in the general case as follows:

$$N_t = 5 * F \text{ 0.0 MHz } \leq F \leq 3276.6 \text{ MHz}$$

where F is the carrier frequency in MHz

Additional channels applicable to operation in the frequency band defined in sub-clause 5.2(d) are defined via the following UARFCN definition:

$$N_t = 5 * (F - 2150.1 \text{ MHz}) / 2572.5 \text{ MHz} \leq F \leq 2617.5 \text{ MHz}$$

UARFCN

1.28 Mcps TDD Option

The following UARFCN range shall be supported for each band:

Table: UTRA Absolute Radio Frequency Channel Number 1.28 Mcps TDD Option

Frequency Band	Frequency Range	UARFCN Uplink and Downlink transmission
For operation in frequency band as defined in subclause 5.2 (a)	1900-1920 MHz	9504 to 9596
	2010-2025 MHz	10054 to 10121
For operation in frequency band as defined in subclause 5.2 (b)	1850-1910 MHz	9254 to 9546
	1930-1990 MHz	9654 to 9946
For operation in frequency band as defined in subclause 5.2 (c)	1910-1930 MHz	9554 to 9646
For operation in frequency band as defined in subclause 5.2 (d)	2570-2620 MHz	12854 to 13096
For operation in frequency band as defined in subclause 5.2 (e)	2300-2400 MHz	11504 to 11996
For operation in frequency band as defined in subclause 5.2 (f)	1880-1920 MHz	9404 to 9596

Radio Setup

Allows access to the sub-menus for selecting the radio standard and associated radio band. You can also set a frequency reference and offset.

This menu is greyed out when on E6630A. Radio band settings for GSM, cdma2000, and so on -- most of which are not actually supported in E6630A, which has three narrow frequency bands. So band settings are grayed out.

Key Path	Source, Frequency
Initial S/W Revision	A.05.00

Radio Standard

Allows access to the channel band sub-menus to select the desired radio standard. When you have selected the radio standard, you can then set an active channel band. The radio standard and the active

channel band allow you to use channel numbers to set frequency automatically.

Key Path	Source, Frequency, Radio Setup
Remote Command	:SOURce:FREQuency:CHANnels:BAND NONE PGSM EGSM RGSM DCS1800 PCS1900 TGSM810 GSM450 GSM480 GSM700 GSM850 BANDI BANDII BANDIII BANDIV BANDV BANDVI BANDVII BANDVIII BANDIX BANDX BANDXI BANDXII BANDXIII BANDXIV BANDXIX USCELL USPCS JAPAN KOREAN NMT IMT2K UPPER SECOND PAMR400 PAMR800 IMTEXT PCS1DOT9G AWS US2DOT5G PUBLIC LOWER BAND1 BAND2 BAND3 BAND4 BAND5 BAND6 BAND7 BAND8 BAND10 BAND11 BAND12 BAND13 BAND14 BAND17 BAND18 BAND19 BAND20 BAND21 BAND24 BAND25 BAND26 BAND27 BAND28 BAND29 BAND30 BAND31 BAND33 BAND34 BAND35 BAND36 BAND37 BAND38 BAND39 BAND40 BAND41 BAND42 BAND43 BAND44 BANDA BANDB BANDC BANDD BANDE BANDF :SOURce:FREQuency:CHANnels:BAND?
Example	:SOUR:FREQ:CHAN:BAND PGSM
Notes	Set this setting to "NONE" will grey out "Channel" on page 2103 Channel
Initial S/W Revision	A.05.00

None

Selects no radio standard for use. When you have selected the radio standard to NONE, you cannot use channel numbers to set frequency automatically. You will need to set the frequency manually.

Key Path	Source, Frequency, Radio Setup, Radio Standard
Initial S/W Revision	A.05.00

GSM/EDGE

Sets GSM/EDGE as the radio standard for use and accesses the GSM/EDGE specific channel band sub-menus.

Key Path	Source, Frequency, Radio Setup, Radio Standard
Initial S/W Revision	A.05.00

P-GSM

Selects P-GSM as the active channel band.

Key Path	Source, Frequency, Radio Setup, Radio Standard, GSM/EDGE
Example	:SOUR:FREQ:CHAN:BAND PGSM
Initial S/W Revision	A.05.00

E-GSM

Selects E-GSM as the active channel band.

Key Path	Source, Frequency, Radio Setup, Radio Standard, GSM/EDGE
Example	:SOUR:FREQ:CHAN:BAND EGSM
Initial S/W Revision	A.05.00

R-GSM

Selects R-GSM as the active channel band.

Key Path	Source, Frequency, Radio Setup, Radio Standard, GSM/EDGE
Example	:SOUR:FREQ:CHAN:BAND RGSM
Initial S/W Revision	A.05.00

DCS 1800

Selects DCS 1800 as the active channel band.

Key Path	Source, Frequency, Radio Setup, Radio Standard, GSM/EDGE
Example	:SOUR:FREQ:CHAN:BAND DCS1800
Initial S/W Revision	A.05.00

PCS 1900

Selects PCS 1900 as the active channel band.

Key Path	Source, Frequency, Radio Setup, Radio Standard, GSM/EDGE
Example	:SOUR:FREQ:CHAN:BAND PCS1900
Initial S/W Revision	A.05.00

GSM 450

Selects GSM 450 as the active channel band.

Key Path	Source, Frequency, Radio Setup, Radio Standard, GSM/EDGE
Example	:SOUR:FREQ:CHAN:BAND GSM450
Initial S/W Revision	A.05.00

GSM 480

Selects GSM 480 as the active channel band.

Key Path	Source, Frequency, Radio Setup, Radio Standard, GSM/EDGE
Example	:SOUR:FREQ:CHAN:BAND GSM480
Initial S/W Revision	A.05.00

GSM 850

Selects GSM 850 as the active channel band.

Key Path	Source, Frequency, Radio Setup, Radio Standard, GSM/EDGE
Example	:SOUR:FREQ:CHAN:BAND GSM850
Initial S/W Revision	A.05.00

GSM 700

Selects GSM 700 as the active channel band.

Key Path	Source, Frequency, Radio Setup, Radio Standard, GSM/EDGE
Example	:SOUR:FREQ:CHAN:BAND GSM700
Initial S/W Revision	A.05.00

T-GSM 810

Selects T-GSM 810 as the active channel band.

Key Path	Source, Frequency, Radio Setup, Radio Standard, GSM/EDGE
Example	:SOUR:FREQ:CHAN:BAND T-GSM810
Initial S/W Revision	A.05.00

WCDMA

Sets WCDMA as the radio standard for use and accesses the W-CDMA specific channel band sub-menus.

Key Path	Source, Frequency, Radio Setup, Radio Standard
Initial S/W Revision	A.05.00

Band I

Selects Band I as the active channel band.

Key Path	Source, Frequency, Radio Setup, Radio Standard, WCDMA
Example	:SOUR:FREQ:CHAN:BAND BANDI
Initial S/W Revision	A.05.00

Band II

Selects Band II as the active channel band.

Key Path	Source, Frequency, Radio Setup, Radio Standard, WCDMA
Example	:SOUR:FREQ:CHAN:BAND BANDII
Initial S/W Revision	A.05.00

Band III

Selects Band III as the active channel band.

Key Path	Source, Frequency, Radio Setup, Radio Standard, WCDMA
Example	:SOUR:FREQ:CHAN:BAND BANDIII
Initial S/W Revision	A.05.00

Band IV

Selects Band IV as the active channel band.

Key Path	Source, Frequency, Radio Setup, Radio Standard, WCDMA
Example	:SOUR:FREQ:CHAN:BAND BANDIV
Initial S/W Revision	A.05.00

Band V

Selects Band V as the active channel band.

Key Path	Source, Frequency, Radio Setup, Radio Standard, WCDMA
Example	:SOUR:FREQ:CHAN:BAND BANDV
Initial S/W Revision	A.05.00

Band VI

Selects Band VI as the active channel band.

Key Path	Source, Frequency, Radio Setup, Radio Standard, WCDMA
Example	:SOUR:FREQ:CHAN:BAND BANDVI
Initial S/W Revision	A.05.00

Band VII

Selects Band VII as the active channel band.

Key Path	Source, Frequency, Radio Setup, Radio Standard, WCDMA
Example	:SOUR:FREQ:CHAN:BAND BANDVII
Initial S/W Revision	A.05.00

Band VIII

Selects Band VIII as the active channel band.

Key Path	Source, Frequency, Radio Setup, Radio Standard, WCDMA
Example	:SOUR:FREQ:CHAN:BAND BANDVIII
Initial S/W Revision	A.05.00

Band IX

Selects Band IX as the active channel band.

Key Path	Source, Frequency, Radio Setup, Radio Standard, WCDMA
Example	:SOUR:FREQ:CHAN:BAND BANDIX
Initial S/W Revision	A.05.00

Band X

Selects Band X as the active channel band.

Key Path	Source, Frequency, Radio Setup, Radio Standard, WCDMA
Example	:SOUR:FREQ:CHAN:BAND BANDX
Initial S/W Revision	A.05.00

Band XI

Selects Band XI as the active channel band.

Key Path	Source, Frequency, Radio Setup, Radio Standard, WCDMA
Example	:SOUR:FREQ:CHAN:BAND BANDXI
Initial S/W Revision	A.05.00

Band XII

Selects Band XII as the active channel band.

Key Path	Source, Frequency, Radio Setup, Radio Standard, WCDMA
Example	:SOUR:FREQ:CHAN:BAND BANDXII
Initial S/W Revision	A.05.00

Band XIII

Selects band XIII as the active channel band.

Key Path	Source, Frequency, Radio Setup, Radio Standard, WCDMA
Example	:SOUR:FREQ:CHAN:BAND BANDXIII
Initial S/W Revision	A.05.00

Band XIV

Selects Band XIV as the active channel band.

Key Path	Source, Frequency, Radio Setup, Radio Standard, WCDMA
Example	:SOUR:FREQ:CHAN:BAND BANDXIV
Initial S/W Revision	A.05.00

LTE

Sets LTE FDD as the radio standard for use and accesses the LTE FDD specific channel band sub-menus..

Key Path	Source, Frequency, Radio Setup, Radio Standard
Initial S/W Revision	A.09.50

BAND 1

Selects BAND 1 as the band for the current step.

Key Path	Source, Frequency, Radio Setup, Radio Standard, LTE
----------	---

Example	:SOUR:FREQ:CHAN:BAND BAND1
Initial S/W Revision	A.09.50

BAND 2

Selects BAND 2 as the band for the current step.

Key Path	Source, Frequency, Radio Setup, Radio Standard, LTE
Example	:SOUR:FREQ:CHAN:BAND BAND2
Initial S/W Revision	A.09.50

BAND 3

Selects BAND 3 as the band for the current step.

Key Path	Source, Frequency, Radio Setup, Radio Standard, LTE
Example	:SOUR:FREQ:CHAN:BAND BAND3
Initial S/W Revision	A.09.50

BAND 4

Selects BAND 4 as the band for the current step.

Key Path	Source, Frequency, Radio Setup, Radio Standard, LTE
Example	:SOUR:FREQ:CHAN:BAND BAND4
Initial S/W Revision	A.09.50

BAND 5

Selects BAND 5 as the band for the current step.

Key Path	Source, Frequency, Radio Setup, Radio Standard, LTE
Example	:SOUR:FREQ:CHAN:BAND BAND5
Initial S/W Revision	A.09.50

BAND 6

Selects BAND 6 as the band for the current step.

Key Path	Source, Frequency, Radio Setup, Radio Standard, LTE
----------	---

Example	:SOUR:FREQ:CHAN:BAND BAND6
Initial S/W Revision	A.09.50

BAND 7

Selects BAND 7 as the band for the current step.

Key Path	Source, Frequency, Radio Setup, Radio Standard, LTE
Example	:SOUR:FREQ:CHAN:BAND BAND7
Initial S/W Revision	A.09.50

BAND 8

Selects BAND 8 as the band for the current step.

Key Path	Source, Frequency, Radio Setup, Radio Standard, LTE
Example	:SOUR:FREQ:CHAN:BAND BAND8
Initial S/W Revision	A.09.50

BAND 9

Selects BAND 9 as the band for the current step.

Key Path	Source, Frequency, Radio Setup, Radio Standard, LTE
Example	:SOUR:FREQ:CHAN:BAND BAND9
Initial S/W Revision	A.09.50

BAND 10

Selects BAND 10 as the band for the current step.

Key Path	Source, Frequency, Radio Setup, Radio Standard, LTE
Example	:SOUR:FREQ:CHAN:BAND BAND10
Initial S/W Revision	A.09.50

BAND 11

Selects BAND 11 as the band for the current step.

Key Path	Source, Frequency, Radio Setup, Radio Standard, LTE
----------	---

Example	:SOUR:FREQ:CHAN:BAND BAND11
Initial S/W Revision	A.09.50

BAND 12

Selects BAND 12 as the band for the current step.

Key Path	Source, Frequency, Radio Setup, Radio Standard, LTE
Example	:SOUR:FREQ:CHAN:BAND BAND12
Initial S/W Revision	A.09.50

BAND 13

Selects BAND 13 as the band for the current step.

Key Path	Source, Frequency, Radio Setup, Radio Standard, LTE
Example	:SOUR:FREQ:CHAN:BAND BAND13
Initial S/W Revision	A.09.50

BAND 14

Selects BAND 14 as the band for the current step.

Key Path	Source, Frequency, Radio Setup, Radio Standard, LTE
Example	:SOUR:FREQ:CHAN:BAND BAND14
Initial S/W Revision	A.09.50

BAND 17

Selects BAND 17 as the band for the current step.

Key Path	Source, Frequency, Radio Setup, Radio Standard, LTE
Example	:SOUR:FREQ:CHAN:BAND BAND17
Initial S/W Revision	A.09.50

BAND 18

Selects BAND 18 as the band for the current step.

Key Path	Source, Frequency, Radio Setup, Radio Standard, LTE
----------	---

Example	:SOUR:FREQ:CHAN:BAND BAND18
Initial S/W Revision	A.09.50

BAND 19

Selects BAND 19 as the band for the current step.

Key Path	Source, Frequency, Radio Setup, Radio Standard, LTE
Example	:SOUR:FREQ:CHAN:BAND BAND19
Initial S/W Revision	A.09.50

BAND 20

Selects BAND 20 as the band for the current step.

Key Path	Source, Frequency, Radio Setup, Radio Standard, LTE
Example	:SOUR:FREQ:CHAN:BAND BAND20
Initial S/W Revision	A.09.50

BAND 21

Selects BAND 21 as the band for the current step.

Key Path	Source, Frequency, Radio Setup, Radio Standard, LTE
Example	:SOUR:FREQ:CHAN:BAND BAND21
Initial S/W Revision	A.09.50

BAND 24

Selects BAND 24 as the band for the current step.

Key Path	Source, Frequency, Radio Setup, Radio Standard, LTE
Example	:SOUR:FREQ:CHAN:BAND BAND24
Initial S/W Revision	A.09.50

BAND 25

Selects BAND 25 as the band for the current step.

Key Path	Source, Frequency, Radio Setup, Radio Standard, LTE
----------	---

Example	:SOUR:FREQ:CHAN:BAND BAND25
Initial S/W Revision	A.09.50

BAND 26

Selects BAND 26 as the band for the current step.

Key Path	Source, Frequency, Radio Setup, Radio Standard, LTE
Example	:SOUR:FREQ:CHAN:BAND BAND26
Initial S/W Revision	A.12.53

BAND 27

Selects BAND 27 as the band for the current step.

Key Path	Source, Frequency, Radio Setup, Radio Standard, LTE
Example	:SOUR:FREQ:CHAN:BAND BAND27
Initial S/W Revision	A.14.00

BAND 28

Selects BAND 28 as the band for the current step.

Key Path	Source, Frequency, Radio Setup, Radio Standard, LTE
Example	:SOUR:FREQ:CHAN:BAND BAND28
Initial S/W Revision	A.14.00

BAND 31

Selects BAND 31 as the band for the current step.

Key Path	Source, Frequency, Radio Setup, Radio Standard, LTE
Example	:SOUR:FREQ:CHAN:BAND BAND31
Initial S/W Revision	A.14.00

LTE TDD

Sets LTE TDD as the radio standard for use and accesses the LTE TDD specific channel band sub-menus..

Key Path	Source, Frequency, Radio Setup, Radio Standard
Initial S/W Revision	A.11.50

BAND 33

Selects BAND 33 as the band for the current step.

Key Path	Source, Frequency, Radio Setup, Radio Standard, LTE TDD
Example	:SOUR:FREQ:CHAN:BAND BAND33
Initial S/W Revision	A.11.50

BAND 34

Selects BAND 34 as the band for the current step.

Key Path	Source, Frequency, Radio Setup, Radio Standard, LTE TDD
Example	:SOUR:FREQ:CHAN:BAND BAND34
Initial S/W Revision	A.11.50

BAND 35

Selects BAND 35 as the band for the current step.

Key Path	Source, Frequency, Radio Setup, Radio Standard, LTE TDD
Example	:SOUR:FREQ:CHAN:BAND BAND35
Initial S/W Revision	A.11.50

BAND 36

Selects BAND 36 as the band for the current step.

Key Path	Source, Frequency, Radio Setup, Radio Standard, LTE TDD
Example	:SOUR:FREQ:CHAN:BAND BAND36
Initial S/W Revision	A.11.50

BAND 37

Selects BAND 37 as the band for the current step.

Key Path	Source, Frequency, Radio Setup, Radio Standard, LTE TDD
Example	:SOUR:FREQ:CHAN:BAND BAND37
Initial S/W Revision	A.11.50

BAND 38

Selects BAND 38 as the band for the current step.

Key Path	Source, Frequency, Radio Setup, Radio Standard, LTE TDD
Example	:SOUR:FREQ:CHAN:BAND BAND38
Initial S/W Revision	A.11.50

BAND 39

Selects BAND 39 as the band for the current step.

Key Path	Source, Frequency, Radio Setup, Radio Standard, LTE TDD
Example	:SOUR:FREQ:CHAN:BAND BAND39
Initial S/W Revision	A.11.50

BAND 40

Selects BAND 40 as the band for the current step.

Key Path	Source, Frequency, Radio Setup, Radio Standard, LTE TDD
Example	:SOUR:FREQ:CHAN:BAND BAND40
Initial S/W Revision	A.11.50

BAND 41

Selects BAND 41 as the band for the current step.

Key Path	Source, Frequency, Radio Setup, Radio Standard, LTE TDD
Example	:SOUR:FREQ:CHAN:BAND BAND41
Initial S/W Revision	A.11.50

BAND 42

Selects BAND 42 as the band for the current step.

Key Path	Source, Frequency, Radio Setup, Radio Standard, LTE TDD
Example	:SOUR:FREQ:CHAN:BAND BAND42
Initial S/W Revision	A.11.50

BAND 43

Selects BAND 43 as the band for the current step.

Key Path	Source, Frequency, Radio Setup, Radio Standard, LTE TDD
Example	:SOUR:FREQ:CHAN:BAND BAND43
Initial S/W Revision	A.11.50

BAND 44

Selects BAND 44 as the band for the current step.

Key Path	Source, Frequency, Radio Setup, Radio Standard, LTE TDD
Example	:SOUR:FREQ:CHAN:BAND BAND44
Initial S/W Revision	A.14.00

TDSCDMA

Sets TDSCDMA as the radio standard for use and accesses the TDSCDMA specific channel band sub-menus..

Key Path	Source, Frequency, Radio Setup, Radio Standard
Initial S/W Revision	A.11.50

BAND A

Selects BAND A as the band for the current step.

Key Path	Source, Frequency, Radio Setup, Radio Standard, TDSCDMA
Example	:SOUR:FREQ:CHAN:BAND BANDA
Initial S/W Revision	A.11.50

BAND B

Selects BAND B as the band for the current step.

Key Path	Source, Frequency, Radio Setup, Radio Standard, TDSCDMA
Example	:SOUR:FREQ:CHAN:BAND BANDB
Initial S/W Revision	A.11.50

BAND C

Selects BAND C as the band for the current step.

Key Path	Source, Frequency, Radio Setup, Radio Standard, TDSCDMA
Example	:SOUR:FREQ:CHAN:BAND BANDC
Initial S/W Revision	A.11.50

BAND D

Selects BAND D as the band for the current step.

Key Path	Source, Frequency, Radio Setup, Radio Standard, TDSCDMA
Example	:SOUR:FREQ:CHAN:BAND BANDD
Initial S/W Revision	A.11.50

BAND E

Selects BAND E as the band for the current step.

Key Path	Source, Frequency, Radio Setup, Radio Standard, TDSCDMA
Example	:SOUR:FREQ:CHAN:BAND BANDE
Initial S/W Revision	A.11.50

BAND F

Selects BAND F as the band for the current step.

Key Path	Source, Frequency, Radio Setup, Radio Standard, TDSCDMA
Example	:SOUR:FREQ:CHAN:BAND BANDF
Initial S/W Revision	A.11.50

Radio Band Link

Allows you to specify the channel band type as either uplink or downlink link direction. This value is used in conjunction with the channel band and channel number to determine the absolute frequency output by the source. When set to “Uplink”, the source will calculate the uplink frequency using an uplink formula together with the selected channel band and channel number . When set to “Downlink”, the source will calculate the downlink frequency using a downlink formula together with the selected channel band and channel number.

Key Path	Source, Frequency, Radio Setup
Remote Command	:SOURce:RADio:BAND:LINK DOWN UP :SOURce:RADio:BAND:LINK?

Example	:SOUR:RAD:BAND:LINK UP
Preset	DOWN
Range	DOWN UP
Backwards Compatibility SCPI	:SOURce:RADio:DEVIce BTS MS :SOURce:RADio:DEVIce?
Backwards Compatibility Notes	BTS maps to the Downlink frequency MS maps to the Uplink frequency
Initial S/W Revision	A.05.00

Set Reference Frequency

This key allows you to set the frequency reference. Pressing this key turns the frequency reference state to ON, sets the reference frequency value to the current frequency, maintains this frequency at the RF output, and sets the displayed frequency to 0.00 Hz. All subsequent frequencies entered under Source>Frequency>Frequency are interpreted as being relative to this reference frequency.

When you use a frequency reference, the signal generator outputs a frequency that is set relative to the reference frequency by the value entered under Source>Frequency>Frequency as follows:

$$\text{Output frequency} = \text{reference frequency} - \text{entered frequency}$$

Where:

reference frequency equals the original RF frequency entered under Source>Frequency>Frequency and set as the reference frequency

entered frequency equals a new value entered under Source>Frequency>Frequency

In addition, the displayed frequency value will be the same as the value entered under Source>Frequency>Frequency.

NOTE

If Freq Reference is set to ON with a reference value set, entering a value under Source>Frequency>Frequency and pressing Set Frequency Reference will add that value to the existing Freq Reference value.

If you wish to change the reference frequency value to the new value entered under Source>Frequency>Frequency, first you must set Freq Reference to OFF and then press Set Frequency Reference.

Key Path	Source, Frequency
Remote Command	:SOURce:FREQuency:REFerence:SET
Example	:SOUR:FREQ:REF:SET
Dependencies	This setting is unavailable, and is grayed out when the List Sequencer is turned ON.
Initial S/W Revision	A.05.00

Freq Reference

This key allows you to toggle the state of the frequency reference. When the frequency reference state is ON, an annunciator is displayed on the main source view to indicate this state to the user.

When you use a frequency reference, the signal generator outputs a frequency that is set relative to the reference frequency by the value entered under Source>Frequency>Frequency as follows:

Output frequency = reference frequency + entered frequency

Where:

reference frequency equals the original RF frequency entered under Source>Frequency>Frequency and set as the reference frequency

entered frequency equals a new value entered under Source>Frequency>Frequency

For more information on Reference Frequency refer to ["Set Reference Frequency" on page 2127](#)

Key Path	Source, Frequency
Remote Command	:SOURce:FREQuency:REFerence <freq> :SOURce:FREQuency:REFerence? :SOURce:FREQuency:REFerence:STATe OFF ON 0 1 :SOURce:FREQuency:REFerence:STATe?
Example	:SOUR:FREQ:REF 0.00 Hz :SOUR:FREQ:REF:STATe ON
Dependencies	This setting is unavailable, and is grayed out when the List Sequencer is turned ON.
Couplings	The frequency reference state is coupled to the frequency reference set immediate action. When the reference set immediate action key is pressed, or the SCPI command issued, it turns the frequency reference state ON.
Preset	0.00 Hz OFF
Min	0.00 Hz
Max	Hardware Dependant: Option 503 = 3.6 GHz Option 504 = 3.8 GHz Option 506 = 6.00 GHz
Initial S/W Revision	A.05.00

Freq Offset

Allows you to specify the frequency offset value. When the frequency offset state is ON, an annunciator is displayed on the main source view to indicate this state to the user.

When the frequency offset is set to zero (0) and you set a new offset value, the displayed frequency value will change as follows and the RF output frequency will not change:

Displayed value = output frequency + offset value

Where:

output frequency equals the original frequency entered under Source>Frequency>Frequency

offset value equals the value entered under Source>Frequency>Freq Offset

When the frequency offset is set to a value other than zero (0) and you enter a new frequency value under Source>Frequency>Frequency, the displayed frequency will be the same as the value entered and the RF output frequency will be equal to the value entered minus the offset value as follows:

Output frequency = entered frequency – offset frequency

Displayed frequency = output frequency + offset frequency

Displayed frequency = entered frequency

Where:

entered frequency equals the frequency entered under Source>Frequency>Frequency

offset frequency equals the value previously entered and set under Source>Frequency>Freq Offset

Key Path	Source, Frequency
Remote Command	:SOURce:FREQuency:OFFSet <freq> :SOURce:FREQuency:OFFSet?
Example	:SOUR:FREQ:OFFS 0 Hz
Dependencies	This setting is unavailable, and is grayed out when the List Sequencer is turned ON.
Preset	0 Hz
Min	-100.00 GHz
Max	100.00 GHz
Initial S/W Revision	A.05.00

Modulation Setup

Allows access to the menus for setting up the available modulation types: "ARB" on page 2143, "AM" on page 2164, "FM" on page 2165, and "PM" on page 2167.

Key Path	Source
Initial S/W Revision	A.05.00

ARB

Allows you access to the ARB sub-menus.

Key Path	Source, Modulation Setup
Initial S/W Revision	A.05.00

ARB

Allows you to toggle the state of the ARB function. When the ARB is On, a “MOD” annunciator is displayed in the system settings panel. When the ARB is turned Off, the MOD annunciator is cleared

Key Path	Source, Modulation Setup, ARB
Remote Command	:SOURce:RADio:ARB[:STATe] ON OFF 1 0 :SOURce:RADio:ARB[:STATe]?
Example	:SOUR:RAD:ARB OFF :SOUR:RAD:ARB?
Notes	If the ARB is ON, a user then loads or deletes another file to ARB memory, the playing waveform segment may not keep phase continuity during the ARB memory operation. The waveform will be replayed after the ARB operation is finished.
Dependencies	This setting is for independent mode and has no effect on 3.3.8 list sequencer mode. Setting "Sequencer" on page 2168 Sequencer to On will put source enter list sequencer mode, and even if ARB state is On, the ARB file will not be played. Setting "Sequencer" on page 2168 Sequencer to Off will make source leave list sequencer mode, and this setting will take effect immediately. The ARB can only be turned on when there is a waveform file selected for playback. On the GUI If no waveform is selected, this key is grayed out. If you send the SCPI command to turn the ARB on with no waveform selected for playback, the ARB state remains OFF and an error is generated. "- When you try to recall a certain set of states in which the selected waveform is not in ARB memory and the ARB state is On, errors are reported
Preset	Off
Range	On Off
Initial S/W Revision	A.05.00

Select Waveform

Allows you to access to the waveform selection sub-menus.

Pressing this key changes the central view area to show the Waveform File Selection view.

Key Path	Source, Modulation Setup, ARB
Initial S/W Revision	A.05.00

Select Waveform

Allows you to select a waveform sequence or segment for the dual ARB to play.

NOTE: Selecting a waveform file does not result in automatic adjustments to burst timing (to compensate for the presence or absence of a Multiport Adapter); that adjustment occurs only when a waveform is loaded to ARB memory. See "Load Segment to ARB Memory" for more information about this adjustment.

Key Path	Source, Modulation Setup, ARB, Select Waveform
Remote Command	:SOURce:RADio:ARB:WAVeform <string> :SOURce:RADio:ARB:WAVeform?
Example	:SOUR:RAD:ARB:WAV "test_waveform.bin"
Notes	<p>If intended waveform is not in the memory yet, then issuing this command by SCPI will invoke ARB loading operation first, which involves a delay of unpredictable length. So this command should be followed by the query *OPC?, which holds off subsequent commands until the loading operating is complete.</p> <p><string> - specifies the name of the waveform segment or waveform sequence to be played by the ARB.</p> <p>When in Sequence Analyzer mode, and Include Source is Yes, if the you attempt to play a waveform sequence but not all the required waveform segments are in the ARB playback memory, the application will reject the loading operation with an error is generated .</p> <p>When Include Source is No, if you attempt to play a waveform sequence but not all the required waveform segments are contained in the ARB playback memory, the application will attempt to load the required segments from either the default directory of the current directory. If the ARB memory does not have enough space for all the waveform segments to be loaded, an error is generated and none of the waveform segments is loaded.</p> <p>If the ARB is ON, and you attempt to play a waveform sequence but not all the waveform segments within the sequence could be found to be loaded into ARB memory, an error is generated. The selected waveform keeps the previous value and ARB state remains On.</p> <p>If you specify a waveform segment over SCPI but the waveform segment is not present within ARB playback memory and cannot be found for auto loading within the current directory or the default directory, an error is generated and the file selection remains unchanged.</p> <p>If you select a waveform for playback and the waveform requires a license that is not installed on the instrument, an error is generated. error is generated.</p> <p>If the ARB is ON and you load a file to ARB memory or delete a file from ARB memory, the playing waveform segment may not keep phase continuity during the ARB memory operation. The waveform will be replayed after the ARB operation is finished.</p>
Initial S/W Revision	A.05.00

Segments on Hard Disk

Allows you access to the sub-menus for loading waveform segments from the hard disk into ARB memory. The default directory is: D: varb.

Pressing this key changes the current view to the Waveform Management View.

Key Path	Source, Modulation Setup, ARB, Select Waveform
Initial S/W Revision	A.05.00

Load Segment To ARB Memory

Allows you to load the selected file into ARB memory. On the front panel you select the file for loading to the ARB memory by highlighting the desired file in the list. Using the SCPI command, you specify the file

name on the HDD.

“NVWFM” (none-volatile storage) MSUS (Mass Storage Unit Specifier) is supported in the memory subsystem because the ARB memory cannot be accessed directly. Therefore, files must be downloaded to the instrument hard disk and then loaded into the ARB memory. “NVWFM” MSUS will be mapped to the default directory D: VARB. The SCPI command supports using either “NVWFM” MSUS or specifying a full path. For more information, see Memory Subsystem (Remote Command Only).

If a file of the same name already exists within ARB memory, it is overwritten. If you wish to load two segments of the same name, you must rename one of the segments before loading it into ARB memory. To rename a segment, you can either use Windows File Explorer, or the :MMEMory:COPI command.

NOTE: When a waveform file is loaded to ARB memory, burst timing adjustments are made automatically, based on whether or not a Multiport Adapter is connected to the test set and powered on. If the connection/power status of the Multiport Adapter is changed after a waveform file has been loaded, it needs to be loaded again.

Key Path	Source, Modulation Setup, ARB, Select Waveform, Segments on Hard Disk
Remote Command	:SOURce:RADio:ARB:LOAD <string>
Example	:SOUR:RAD:ARB:LOAD "D: VARB\testwaveform.bin" or :SOUR:RAD:ARB:LOAD "NVWFM:testwaveform.bin"
Notes	<p>Because loading the file involves a delay of unpredictable length, this command should be followed by the query *OPC?, which holds off subsequent commands until the loading operating is complete.</p> <p><string> – specifies the path name of the file to load from the HDD into ARB memory. It could be a <full path + filename>, or <“NVWFM” MSUS + colon + filename>.</p> <p>When in Sequence Analyzer mode, and Include Source is Yes, an attempt to load a file to ARB memory will be rejected with an error.</p> <p>When Include Source is No and if there is insufficient free ARB memory to load the selected waveform, an error is generated. .</p> <p>If you specify a file over SCPI, but the file is not at the specified location, an error is generated.</p> <p>If you try to load a waveform file but the file contains less than 500 IQ samples, an error is generated.</p> <p>If you try to load a Signal Studio waveform “*.wfm” which contains invalid waveform header, an error is generated.</p> <p>If the ARB is ON when you load a file to ARB memory or delete a file from ARB memory, the playing waveform segment may not keep phase continuity during the ARB memory operation. The waveform will be replayed after the ARB operation is finished.</p> <p>ARB can be loaded into ARB memory even required licenses do not present on the instrument. In this case, a GUI only warning message -800, “Operation complete; Loaded <filename> successfully, but no license <required licenses> installed”. User can install required licenses according to <required licenses> string to license it, or multi-pack license it.</p>
Initial S/W Revision	A.05.00

Load All To ARB Memory

Allows you to load all the segment files within the currently selected directory into ARB memory. If a file of the same name already exists within ARB memory, it is overwritten. If you wish to load two segments of the

same name, you must rename one of the segments before loading it into ARB memory. To rename a segment, you can either use Windows File Explorer, or the :MEMory:COpy command.

NOTE: When a waveform file is loaded to ARB memory, burst timing adjustments are made automatically, based on whether or not a Multiport Adapter is connected to the test set and powered on. If the connection/power status of the Multiport Adapter is changed after a waveform file has been loaded, it needs to be loaded again.

Key Path	Source, Modulation Setup, ARB, Select Waveform, Segments on Hard Disk
Remote Command	:SOURce:RADio:ARB:LOAD:ALL <string>
Example	:SOUR:RAD:ARB:LOAD:ALL "D: varb"
Notes	<p><string> - specifies the directory on the HDD to load the files into ARB memory from.</p> <p>When in Sequence Analyzer mode, and Include Source is Yes, an attempt to load all files from a directory to ARB memory is rejected with an error.</p> <p>When Include Source is No and there is insufficient free ARB memory to load all the waveforms, when the ARB memory is full, the copy ceases, and an error is generated.</p> <p>If you specify a directory over SCPI, but the directory does not exist, an error is generated.</p> <p>If the ARB is ON, a user then loads or deletes file to ARB memory, the playing waveform segment may not keep phase continuity during the ARB memory operation. The waveform will be replayed after the ARB operation is finished.</p>
Initial S/W Revision	A.05.00

Change Directory...

Allows you to change the currently selected directory on the hard disk. Pressing this key opens a standard windows change directory dialog allowing you to select the new directory of interest.

The current directory is used for manually loading waveform segments into ARB memory for playback, and as a search location for waveform segments that are required to be loaded into ARB memory for playback of a waveform sequence or a list sequence.

Key Path	Source, Modulation Setup, ARB, Select Waveform, Segments on Hard Disk
Notes	No remote command, SCPIfront panel only.
Initial S/W Revision	A.05.00

Default Directory...

Allows you to change the default directory. It is used as a search location for waveform segments that are required to be loaded into ARB memory for playback of a waveform sequence, and as a search location for selecting waveforms using SCPI.

Key Path	Source, Modulation Setup, ARB, Select Waveform, Segments on Hard Disk
Remote Command	:SOURce:RADio:ARB:DEFault:DIRectory <string> :SOURce:RADio:ARB: DEFault:DIRectory?
Example	:SOUR:RAD:ARB:DEF:DIR "D:\ArbFiles"

	:SOUR:RAD:ARB:DEF:DIR?
State Saved	Persistent, survives a power cycle and a preset but not saved in the instrument state
Initial S/W Revision	A.05.00

Segments in ARB Memory

Allows you access to the sub-menus for managing the files within ARB memory.

Key Path	Source, Modulation Setup, ARB, Select Waveform
Initial S/W Revision	A.05.00

Delete Segment From ARB Mem

Allows you to remove a segment from ARB playback memory.

Key Path	Source, Modulation Setup, ARB, Select Waveform, Segments in ARB Memory
Remote Command	:SOURce:RADio:ARB:DELeTe <string>
Example	:SOUR:RAD:ARB:DEL "testwaveform.bin"
Notes	<p><string> - specifies the waveform to be deleted from the ARB playback memory.</p> <p>When in Sequence Analyzer mode and Include Source is Yes, an attempt to delete a file from ARB memory is rejected with an error.</p> <p>When Include Source is No and you specify a file that does not exist within ARB memory, an error is generated.</p> <p>It is possible to delete files from within the ARB memory when the ARB is ON. However, if you attempt to delete the file that is currently playing an error is generated.</p> <p>It is possible to delete a file from within the ARB memory when the sequencer state is ON and the file is not being used by the List Sequencer. If you attempt to delete a file which is being used by the list sequencer, an error is generated.</p> <p>When sequencer state is On, even if ARB state is On, the selected waveform will not be played. In this case, if the selected waveform is not used in List Sequence, it can be deleted and the ARB state is turned Off.</p> <p>If the ARB is ON and you load a file to ARB memory or delete a file from ARB memory, the playing waveform segment may not keep phase continuity during the ARB memory operation. The waveform will be replayed after the ARB operation is finished.</p>
Initial S/W Revision	A.05.00

Delete All From ARB Memory

Allows you to remove all segments from ARB playback memory.

Key Path	Source, Modulation Setup, ARB, Select Waveform, Segments in ARB Memory
----------	--

Remote Command	:SOURce:RADio:ARB:DELeTe:ALL
Example	:SOUR:RAD:ARB:DELeTe:ALL
Notes	<p>When in Sequence Analyzer mode and Include Source is Yes, an attempt to delete all files from ARB memory is rejected with an error.</p> <p>When Include Source is No and you attempt to delete all files from ARB memory when the ARB is currently playing a file, all files except the one playing are deleted and an error is generated.</p> <p>If you attempt to delete all files from ARB memory when there are waveform files used in "List Sequencer" on page 2168 and "Sequencer" on page 2168 state is ON, all files except the files currently being used in list sequencer are deleted, and an error is generated.</p> <p>If the ARB is ON and you load a file to ARB memory or delete a file from ARB memory, the playing waveform segment may not keep phase continuity during the ARB memory operation. The waveform will be replayed after the ARB operation is finished.</p>
Initial S/W Revision	A.05.00

ARB Setup

Allows access to the ARB setup sub-menus.

Key Path	Source, Modulation Setup, ARB
Initial S/W Revision	A.05.00

Sample Rate

Allows you to set the ARB waveform playback sample rate.

Key Path	Source, Modulation Setup, ARB, ARB Setup
Remote Command	:SOURce:RADio:ARB:SCLock:RATE <freq> :SOURce:RADio:ARB:SCLock:RATE?
Example	:SOUR:RAD:ARB:SCL:RATE 48.00 MHz
Notes	If there is a sample rate specified in the header of the waveform file, changing that sample rate is not recommended, as it may cause problems with burst timing.
Dependencies	When a new waveform is selected for playback the settings contained within the associated waveform header file are applied to the ARB. The sample rate is one of the values stored within the header file. If the newly selected waveform file has an associated header file, the sample rate is updated with the value from the header file. The sample rate will remain unchanged if the newly selected waveform does not have an associated header file.
Preset	125.00 MHz
Min	1.00 kHz
Max	125.00 MHz
Initial S/W Revision	A.05.00

Run-Time Scaling

Allows you to adjust the run-time scaling value. The run-time scaling value is applied in real-time while the waveform is playing.

Key Path	Source, Modulation Setup, ARB, ARB Setup
Remote Command	:SOURce:RADio:ARB:RSCaling <real> :SOURce:RADio:ARB:RSCaling?
Example	:SOUR:RAD:ARB:RSC 100.00
Notes	This setting cannot be set in E6640A/M9420A. Grey out on menu and the value is fixed at 70.00%.
Dependencies	When a new waveform is selected for playback the settings contained within the associated waveform header file are applied to the ARB. The run-time scaling is one of the values stored within the header file. If the newly selected waveform file has an associated header file, the run-time scaling is updated with the value from the header file. The run-time scaling will remain unchanged if the newly selected waveform does not have an associated header file.
Preset	70.00 %
Min	1.00 %
Max	100.00 %
Initial S/W Revision	A.05.00

Baseband Freq Offset

Allows you to adjust the value by which the baseband frequency is offset relative to the carrier.

Key Path	Source, Modulation Setup, ARB, ARB Setup
Remote Command	:SOURce:RADio:ARB:BASEband:FREQuency:OFFSet <freq> :SOURce:RADio:ARB:BASEband:FREQuency:OFFSet?
Example	:SOUR:RAD:ARB:BAS:FREQ:OFFS 0.00 Hz
Dependencies	When a new waveform is selected for playback the settings contained within the associated waveform header file are applied to the ARB. The baseband frequency offset is one of the values stored within the header file. If the newly selected waveform file has an associated header file, the baseband frequency offset is updated with the value from the header file. The baseband frequency offset will remain unchanged if the newly selected waveform does not have an associated header file.
Preset	0.00 Hz
Min	-50.00 MHz
Max	50.00 MHz
Initial S/W Revision	A.05.00

Edit RMS

Allows you to edit or calculate current RMS of selected waveform.

Key Path	Source, Modulation Setup, ARB, ARB Setup
Initial S/W Revision	A.14.50

Current RMS

Allows you to directly specify current RMS value used to playback currently selected waveform. Please note incorrect RMS value may cause inaccurate power output in E6640A/M9420A that is sensitive to RMS value.

This setting is also updated by RMS in waveform header or updated when invoking RMS calculation operation.

This setting can be saved to the header of currently selected waveform by invoking ["Save Setup To Header" on page 2164](#) "Save Setup To Header".

Key Path	Source, Modulation Setup, ARB, ARB Setup, Edit RMS
Remote Command	:SOURce:RADio:ARB:RMS <float> :SOURce:RADio:ARB:RMS?
Example	:SOUR:RAD:ARB:HEAD:RMS 0.7 :SOUR:RAD:ARB:HEAD:RMS?
Notes	Valid range is 0 to 1.414, values outside the range will be clipped to the closest boundary. Note this value does not affect "List Sequencer" on page 2168 Source List Sequencer that always uses RMS value resides in each ARB header. If want this value to take effect in list sequencer, use "Save Setup To Header" on page 2164 "Save Setup to Header" to save current RMS value to header first, then play the ARB in source list sequencer.
Dependencies	When a new waveform is selected for playback, this setting is updated by the RMS value defined in associated waveform header file. If selected waveform has no associated header file or header file does not specify RMS value, then instrument will try to calculate out one automatically. Calculating RMS can also update this setting.
Preset	0
Range	0 ~ 1.414
Initial S/W Revision	A.14.50

RMS Calculation Mode

Allows you to specify the mode to calculate the current RMS.

Key Path	Source, Modulation Setup, ARB, ARB Setup, Edit RMS
Remote Command	:SOURce:RADio:ARB:RMS:CALCulation:MODE AUTO M1 M2 M3 M4 :SOURce:RADio:ARB:RMS:CALCulation:MODE?
Example	:SOUR:RAD:ARB:RMS:CALC:MODE AUTO
Notes	If no waveform is selected, or selected waveform is waveform sequence, the key will grey out.

Preset	AUTO
Range	AUTO M1 M2 M3 M4
Initial S/W Revision	A.14.50

Auto

RMS will be calculated based on the whole sample range of current selected waveform.

Key Path	Source, Modulation Setup, ARB, ARB Setup, Edit RMS, Calculate RMS, RMS Calculation Mode
Example	:SOUR:RAD:ARB:RMS:CALC:MODE AUTO
Initial S/W Revision	A.14.50

Marker 1

Selects marker 1 to designate sample range used for RMS calculation.

Key Path	Source, Modulation Setup, ARB, ARB Setup, Edit RMS, Calculate RMS, RMS Calculation Mode , Marker
Example	:SOUR:RAD:ARB:RMS:CALC:MODE M1
Initial S/W Revision	A.14.50

Marker 2

Selects marker 2 to designate sample range used for RMS calculation.

Key Path	Source, Modulation Setup, ARB, ARB Setup, Edit RMS, Calculate RMS, RMS Calculation Mode , Marker
Example	:SOUR:RAD:ARB:RMS:CALC:MODE M2
Initial S/W Revision	A.14.50

Marker 3

Selects marker 3 to designate sample range used for RMS calculation.

Key Path	Source, Modulation Setup, ARB, ARB Setup, Edit RMS, Calculate RMS, RMS Calculation Mode , Marker
Example	:SOUR:RAD:ARB:RMS:CALC:MODE M3
Initial S/W Revision	A.14.50

Marker 4

Selects marker 4 to designate sample range used for RMS calculation.

Key Path	Source, Modulation Setup, ARB, ARB Setup, Edit RMS, Calculate RMS, RMS Calculation Mode , Marker
Example	:SOUR:RAD:ARB:RMS:CALC:MODE M4
Initial S/W Revision	A.14.50

Calculate RMS

Allows you to calculate current RMS based on mode selected. This will update ["Current RMS" on page 2137](#) Current RMS setting.

Key Path	Source, Modulation Setup, ARB, ARB Setup, Edit RMS, Calculate RMS
Remote Command	:SOURce:RADio:ARB:RMS:CALCulate
Example	:SOUR:RAD:ARB:RMS:CALC
Notes	<p>If no waveform is selected, invoking this operation will get error “-221 Setting conflict; No waveform is selected for RMS operation”.</p> <p>If no waveform is selected, or selected waveform is waveform sequence, the key will grey out.</p> <p>If selected waveform does not contain marker data, but "RMS Calculation Mode" on page 2137 “RMS Calculation Mode” is set to marker, under this circumstance, invoking calculation operation will get error “-221 Setting conflict; There is no marker for currently selected waveform, auto RMS calculation mode is used instead”, and "RMS Calculation Mode" on page 2137 “RMS Calculation Mode” will be coupled to “Auto” mode automatically.</p> <p>RMS calculation does not suit for waveform sequence. If selected waveform is waveform sequence file, invoking this operation will get error “-221 Setting conflict; RMS calculation does not apply to waveform sequence”. But users can still edit current RMS as play parameter, and can save current RMS to waveform sequence header for later use.</p>
Initial S/W Revision	A.14.50

Use Header RMS

Allows you to quickly set RMS in ARB header to ["Current RMS" on page 2137](#) Current RMS setting.

Key Path	Source, Modulation Setup, ARB, ARB Setup, Edit RMS,
Notes	<p>No remote command, front panel only.</p> <p>If no waveform is selected, the key will grey out.</p> <p>If no waveform is selected, invoking this operation will get error “-221 Setting conflict; No waveform is selected for RMS operation”.</p>
Initial S/W Revision	A.14.50

Trigger Type

Allows access to the trigger type sub-menus. The setting for trigger type determines the behavior of the waveform when it plays.

Key Path	Source, Modulation Setup, ARB
Remote Command	:SOURce:RADio:ARB:TRIGger:TYPE CONTInuous SINGle SADVance :SOURce:RADio:ARB:TRIGger:TYPE?
Example	:SOUR:RAD:ARB:TRIG:TYPE CONT :SOUR:RAD:ARB:TRIG:TYPE?
Notes	Gated trigger type will be implemented at a later release
Preset	CONTInuous
Range	Continuous Single Seg Adv
Initial S/W Revision	A.05.00

Continuous

Sets the active trigger type to Continuous. If Continuous is already selected as the active trigger type, pressing this key allows access to the continuous trigger type setup menu. In Continuous trigger mode, the waveform repeats continuously.

Key Path	Source, Modulation Setup, ARB, Trigger Type
Remote Command	:SOURce:RADio:ARB:TRIGger:TYPE:CONTInuous[:TYPE] FREE TRIGger RESet :SOURce:RADio:ARB:TRIGger:TYPE:CONTInuous[:TYPE]?
Example	:SOUR:RAD:ARB:TRIG:TYPE:CONT FREE
Preset	FREE
Range	Free Run Trigger + Run Reset + Run
Initial S/W Revision	A.05.00

Free Run

Selects Free Run as the trigger response for the continuous trigger type. Free Run sets the waveform generator to play a waveform sequence or segment continuously, without waiting for a trigger. In this mode, the waveform generator does not respond to triggers.

Key Path	Source, Modulation Setup, ARB, Trigger Type, Continuous
Example	:SOUR:RAD:ARB:TRIG:TYPE:CONT FREE
Initial S/W Revision	A.05.00

Trigger + Run

Sets Trigger and Run as the trigger response for the continuous trigger type. Trigger and Run sets the waveform generator to play a waveform sequence or segment continuously when the first trigger is received, and to ignore any subsequent triggers.

Key Path	Source, Modulation Setup, ARB, Trigger Type, Continuous
Example	:SOUR:RAD:ARB:TRIG:TYPE:CONT TRIG
Initial S/W Revision	A.05.00

Reset + Run

Sets Reset and Run as the trigger response for the continuous trigger type. Reset and Run sets the waveform generator to play a waveform sequence or segment continuously when the first trigger is received. Subsequent triggers reset the waveform sequence or segment to the start, and then play it continuously.

Key Path	Source, Modulation Setup, ARB, Trigger Type, Continuous
Example	:SOUR:RAD:ARB:TRIG:TYPE:CONT RES
Initial S/W Revision	A.05.00

Single

Sets the active trigger type to Single. If Single is already selected as the active trigger type, pressing this key allows access to the single trigger type setup menu. In Single trigger mode, the waveform plays once.

Key Path	Source, Modulation Setup, ARB, Trigger Type
Remote Command	:SOURce:RADio:ARB:RETRigger ON OFF IMMediate :SOURce:RADio:ARB:RETRigger?
Example	:SOUR:RAD:ARB:RETR OFF
Notes	ON: Buffered Trigger OFF: No Retrigger Immediate: Restart on Trigger This is defined as an enumerated SCPI command, with ON OFF being considered as enumerated types rather than Boolean. This means the query will return OFF instead of 0, and ON instead of 1.
Preset	ON
Range	No Retrigger Buffered Trigger Restart on Trigger
Initial S/W Revision	A.05.00

No Retrigger

Selects No Retrigger as the trigger response for single trigger type. No Retrigger sets the waveform generator to play a waveform sequence or segment once when a trigger is received. Any triggers then

received during playback are ignored.

Key Path	Source, Modulation Setup, ARB, Trigger Type, Single
Example	:SOUR:RAD:ARB:RETR OFF
Initial S/W Revision	A.05.00

Buffered Trigger

Selects Buffered Trigger as the trigger response for single trigger type. Buffered Trigger sets the waveform generator to play a waveform sequence or segment once when a trigger is received. If a trigger is received during playback, the waveform generator plays the sequence or segment to the end, then plays the sequence or segment once more.

Key Path	Source, Modulation Setup, ARB, Trigger Type, Single
Example	:SOUR:RAD:ARB:RETR ON
Initial S/W Revision	A.05.00

Restart on Trigger

Selects Restart on Trigger as the trigger response for single trigger type. Restart on Trigger sets the waveform generator to play a waveform sequence or segment once when a trigger is received. If a trigger is received during playback, the waveform generator resets and plays the sequence or segment from the start.

Key Path	Source, Modulation Setup, ARB, Trigger Type, Single
Example	:SOUR:RAD:ARB:RETR IMM
Initial S/W Revision	A.05.00

Segment Advance

Sets the active trigger type to Segment Advance. If Segment Advance is already selected as the active trigger type, pressing this key allows access to the segment advance trigger type setup menu.

Segment Advance triggering allows you to control the playback of waveform segments within a waveform sequence. When a trigger is received the ARB advances to the next waveform segment within the waveform sequence. This type of triggering ignores the repetition count for the waveform segment within the waveform sequence. For example, if a waveform segment has a repetition count of 10 and you select single segment advance triggering mode, the waveform segment will only play once.

Segment Advance triggering can also be used for waveform segments only. In this situation the same waveform segment is played again when a trigger is received.

Key Path	Source, Modulation Setup, ARB, Trigger Type
Remote Command	:SOURce:RADio:ARB:TRIGger:TYPE:SADvance[:TYPE] SINGLE CONTInuous

	:SOURce:RADio:ARB:TRIGger:TYPE:SADVance[:TYPE]?
Example	:SOUR:RAD:ARB:TRIG:TYPE:SADV SING
Preset	CONTInuous
Range	Single Continuous
Initial S/W Revision	A.05.00

Single

Selects Single as the trigger response for Segment Advance trigger type. With single selected, once a trigger is received a segment is played once. If a trigger is received during playback of a segment, the segment plays to completion and the next segment is played once.

Key Path	Source, Modulation Setup, ARB, Trigger Type, Segment Advance
Example	:SOUR:RAD:ARB:TRIG:TYPE:SADV SING
Initial S/W Revision	A.05.00

Continuous

Selects Continuous as the trigger response for Segment Advance trigger type. With continuous selected, once a trigger is received a segment is played continuously. When subsequent triggers are received, the currently playing segment plays to completion and then the next segment is played continuously.

Key Path	Source, Modulation Setup, ARB, Trigger Type, Segment Advance
Example	:SOUR:RAD:ARB:TRIG:TYPE:SADV CONT
Initial S/W Revision	A.05.00

ARB

Allows you access to the ARB sub-menus.

Key Path	Source, Modulation Setup
Initial S/W Revision	A.05.00

Trigger Source

The trigger source setting determines how the source receives the trigger that starts the waveform playing. Therefore, this key is grayed out if the trigger type is free run, since free run triggers immediately with no trigger source required.

Key Path	Source, Modulation Setup, ARB
Remote Command	:SOURce:RADio:ARB:TRIGger[:SOURce] KEY BUS EXTeRnal2

	:SOURce:RADio:ARB:TRIGger[:SOURce]?
Example	:SOUR:RAD:ARB:TRIGger KEY
Dependencies	This key is grayed out if the current trigger type is Continuous, Free Run.
Preset	EXTernal2
Range	Trigger Key Bus External 2
Initial S/W Revision	A.05.00

Trigger Key

Sets the current trigger source to the front panel Trigger key. When Trigger Key is selected, the waveform is triggered when you press the front panel Trigger key.

Key Path	Source, Modulation Setup, ARB, Trigger Source
Example	:SOUR:RAD:ARB:TRIGger KEY
Initial S/W Revision	A.05.00

Bus

Sets the current trigger source to Bus. Selecting Bus trigger source enables triggering over GPIB, LAN, or USB using the :SOURce:RADio:ARB:TRIGger:INITiate command.

Key Path	Source, Modulation Setup, ARB, Trigger Source
Example	:SOUR:RAD:ARB:TRIGger BUS
Initial S/W Revision	A.05.00

External 2

Sets the current trigger source to External 2. Selecting External 2 enables triggering a waveform by an externally applied signal.

Key Path	Source, Modulation Setup, ARB, Trigger Source
Example	:SOUR:RAD:ARB:TRIGger EXT2
Notes	Note: When on E6640A, trigger 2 is a bi-directional trigger port. So when trigger 2 has been configured as OUTPUT type, choosing External 2 as the input trigger for the current step will generate error.
Initial S/W Revision	A.05.00

External Trigger Delay

This key allows you to toggle the state and value of external trigger delay. The value you enter sets a delay time between when an external trigger is received and when it is applied to the waveform. This is key is

active only if you select external trigger as trigger source.

Key Path	Source, Modulation Setup, ARB, Trigger Source
Remote Command	:SOURce:RADio:ARB:TRIGger[:SOURce]:EXTErnal:DELay <time> :SOURce:RADio:ARB:TRIGger[:SOURce]:EXTErnal:DELay? SOURce:RADio:ARB:TRIGger[:SOURce]:EXTErnal:DELay:STATe OFF ON 0 1 :SOURce:RADio:ARB:TRIGger[:SOURce]:EXTErnal:DELay:STATe?
Example	:SOUR:RAD:ARB:TRIG:EXT:DEL 100ns :SOUR:RAD:ARB:TRIG:EXT:DEL? :SOUR:RAD:ARB:TRIG:EXT:DEL:STAT ON :SOUR:RAD:ARB:TRIG:EXT:DEL:STAT?
Notes	External trigger delay time set by users will be rounded to the nearest integer multiple of the resolution.
Dependencies	This setting is unavailable and is grayed out when the Trigger Source is not set to external trigger.
Preset	1 ms OFF
Min	0 s
Max	8.589934588 s (Note: This value comes from $4\text{ns} * (2^{31} - 1) = 8589934588\text{ ns}$)
Initial S/W Revision	A.14.50

Trigger Initiate

Used to initiate an immediate trigger event if the trigger source is set to Trigger Key.

Key Path	Source, Modulation Setup, ARB
Notes	No remote command, SCPI front panel only.
Initial S/W Revision	A.05.00

Waveform Sequences

Allows access to the waveform sequence sub-menus. Pressing this key changes the central view area to display the Waveform Sequence List view.

Key Path	Source, Modulation Setup, ARB
Notes	No remote command, SCPI front panel only.
Initial S/W Revision	A.05.00

Build New Sequence

Allows access to the sub-menus for creating a new waveform sequence. Pressing this key changes the central view area to display the Waveform Sequence Creation and Editing view.

Key Path	Source, Modulation Setup, ARB, Waveform Sequences
Notes	No remote command, SCPI front panel only.
Initial S/W Revision	A.05.00

Current Segment

Specifies the selected sequence segment that will be affected by the menu functions.

Key Path	Source, Modulation Setup , ARB, Waveform Sequences, Build New Sequence
Notes	No remote command, SCPI front panel only. This key is grayed out and unavailable if the sequence is currently empty.
Initial S/W Revision	A.05.00

Insert New Waveform

Allows you access to the sub-menu for inserting a new waveform segment or sequence. Pressing this key also changes the central display to show the Waveform File Selection View.

Key Path	Source, Modulation Setup, ARB, Waveform Sequences, Build New Sequence
Notes	No remote command, SCPI front panel only. Waveform segment name string length upper limit is 128 chars. Please do NOT insert waveform which name string exceeds 128 chars.
Initial S/W Revision	A.05.00

Insert Waveform

Inserts the currently highlighted waveform to the end of the waveform sequence. Pressing this key also returns you to the menus for creating or editing a sequence, and returns the central view to the sequence creation view.

Key Path	Source, Modulation Setup, ARB, Waveform Sequences, Build New Sequence, Insert New Waveform
Notes	No remote command, SCPI front panel only. Waveform segment name string length upper limit is 128 chars. Please do NOT insert waveform which name string exceeds 128 chars.
Initial S/W Revision	A.05.00

Segments on Hard Disk

Allows you access to the sub-menus for loading waveform segments from the hard disk into ARB memory. The default directory is: D: varb.

Pressing this key changes the current view to the Waveform Management View.

Key Path	Source, Modulation Setup, ARB, Select Waveform
Initial S/W Revision	A.05.00

Load Segment To ARB Memory

Allows you to load the selected file into ARB memory. On the front panel you select the file for loading to the ARB memory by highlighting the desired file in the list. Using the SCPI command, you specify the file name on the HDD.

“NVWFM” (none-volatile storage) MSUS (Mass Storage Unit Specifier) is supported in the memory subsystem because the ARB memory cannot be accessed directly. Therefore, files must be downloaded to the instrument hard disk and then loaded into the ARB memory. “NVWFM” MSUS will be mapped to the default directory D: VARB. The SCPI command supports using either “NVWFM” MSUS or specifying a full path. For more information, see Memory Subsystem (Remote Command Only).

If a file of the same name already exists within ARB memory, it is overwritten. If you wish to load two segments of the same name, you must rename one of the segments before loading it into ARB memory. To rename a segment, you can either use Windows File Explorer, or the :MMEMory:COPI command.

NOTE: When a waveform file is loaded to ARB memory, burst timing adjustments are made automatically, based on whether or not a Multiport Adapter is connected to the test set and powered on. If the connection/power status of the Multiport Adapter is changed after a waveform file has been loaded, it needs to be loaded again.

Key Path	Source, Modulation Setup, ARB, Select Waveform, Segments on Hard Disk
Remote Command	:SOURce:RADio:ARB:LOAD <string>
Example	:SOUR:RAD:ARB:LOAD "D: VARB\testwaveform.bin" or :SOUR:RAD:ARB:LOAD "NVWFM:testwaveform.bin"
Notes	<p>Because loading the file involves a delay of unpredictable length, this command should be followed by the query *OPC?, which holds off subsequent commands until the loading operating is complete.</p> <p><string> – specifies the path name of the file to load from the HDD into ARB memory. It could be a <full path + filename>, or <"NVWFM" MSUS + colon + filename>.</p> <p>When in Sequence Analyzer mode, and Include Source is Yes, an attempt to load a file to ARB memory will be rejected with an error.</p> <p>When Include Source is No and if there is insufficient free ARB memory to load the selected waveform, an error is generated. .</p> <p>If you specify a file over SCPI, but the file is not at the specified location, an error is generated.</p> <p>If you try to load a waveform file but the file contains less than 500 IQ samples, an error is generated.</p> <p>If you try to load a Signal Studio waveform "*.wfm" which contains invalid waveform header, an error is generated.</p>

If the ARB is ON when you load a file to ARB memory or delete a file from ARB memory, the playing waveform segment may not keep phase continuity during the ARB memory operation. The waveform will be replayed after the ARB operation is finished.

ARB can be loaded into ARB memory even if required licenses do not present on the instrument. In this case, a GUI only warning message -800, "Operation complete; Loaded <filename> successfully, but no license <required licenses> installed". User can install required licenses according to <required licenses> string to license it, or multi-pack license it.

Initial S/W Revision	A.05.00
----------------------	---------

Load All To ARB Memory

Allows you to load all the segment files within the currently selected directory into ARB memory. If a file of the same name already exists within ARB memory, it is overwritten. If you wish to load two segments of the same name, you must rename one of the segments before loading it into ARB memory. To rename a segment, you can either use Windows File Explorer, or the :MEMORY:COPY command.

NOTE: When a waveform file is loaded to ARB memory, burst timing adjustments are made automatically, based on whether or not a Multiport Adapter is connected to the test set and powered on. If the connection/power status of the Multiport Adapter is changed after a waveform file has been loaded, it needs to be loaded again.

Key Path	Source, Modulation Setup, ARB, Select Waveform, Segments on Hard Disk
Remote Command	:SOURce:RADio:ARB:LOAD:ALL <string>
Example	:SOUR:RAD:ARB:LOAD:ALL "D: varb"
Notes	<p><string> - specifies the directory on the HDD to load the files into ARB memory from.</p> <p>When in Sequence Analyzer mode, and Include Source is Yes, an attempt to load all files from a directory to ARB memory is rejected with an error.</p> <p>When Include Source is No and there is insufficient free ARB memory to load all the waveforms, when the ARB memory is full, the copy ceases, and an error is generated.</p> <p>If you specify a directory over SCPI, but the directory does not exist, an error is generated.</p> <p>If the ARB is ON, a user then loads or deletes file to ARB memory, the playing waveform segment may not keep phase continuity during the ARB memory operation. The waveform will be replayed after the ARB operation is finished.</p>
Initial S/W Revision	A.05.00

Change Directory...

Allows you to change the currently selected directory on the hard disk. Pressing this key opens a standard windows change directory dialog allowing you to select the new directory of interest.

The current directory is used for manually loading waveform segments into ARB memory for playback, and as a search location for waveform segments that are required to be loaded into ARB memory for playback of a waveform sequence or a list sequence.

Key Path	Source, Modulation Setup, ARB, Select Waveform, Segments on Hard Disk
Notes	No remote command, SCPI front panel only.
Initial S/W Revision	A.05.00

Default Directory...

Allows you to change the default directory. It is used as a search location for waveform segments that are required to be loaded into ARB memory for playback of a waveform sequence, and as a search location for selecting waveforms using SCPI.

Key Path	Source, Modulation Setup, ARB, Select Waveform, Segments on Hard Disk
Remote Command	:SOURce:RADio:ARB:DEFault:DIRectory <string> :SOURce:RADio:ARB: DEFault:DIRectory?
Example	:SOUR:RAD:ARB:DEF:DIR "D:\ArbFiles" :SOUR:RAD:ARB:DEF:DIR?
State Saved	Persistent, survives a power cycle and a preset but not saved in the instrument state
Initial S/W Revision	A.05.00

Segments in ARB Memory

Allows you access to the sub-menus for managing the files within ARB memory.

Key Path	Source, Modulation Setup, ARB, Select Waveform
Initial S/W Revision	A.05.00

Delete Segment From ARB Mem

Allows you to remove a segment from ARB playback memory.

Key Path	Source, Modulation Setup, ARB, Select Waveform, Segments in ARB Memory
Remote Command	:SOURce:RADio:ARB:DELete <string>
Example	:SOUR:RAD:ARB:DEL "testwaveform.bin"
Notes	<string> - specifies the waveform to be deleted from the ARB playback memory. When in Sequence Analyzer mode and Include Source is Yes, an attempt to delete a file from ARB memory is rejected with an error. When Include Source is No and you specify a file that does not exist within ARB memory, an error is generated. It is possible to delete files from within the ARB memory when the ARB is ON. However, if you attempt to delete the file that is currently playing an error is generated. It is possible to delete a file from within the ARB memory when the sequencer state is ON and the file is not being used by the List Sequencer. If you attempt to delete a file which is being used by the list

sequencer, an error is generated.

When sequencer state is On, even if ARB state is On, the selected waveform will not be played. In this case, if the selected waveform is not used in List Sequence, it can be deleted and the ARB state is turned Off.

If the ARB is ON and you load a file to ARB memory or delete a file from ARB memory, the playing waveform segment may not keep phase continuity during the ARB memory operation. The waveform will be replayed after the ARB operation is finished.

Initial S/W Revision A.05.00

Delete All From ARB Memory

Allows you to remove all segments from ARB playback memory.

Key Path	Source, Modulation Setup, ARB, Select Waveform, Segments in ARB Memory
Remote Command	:SOURce:RADio:ARB:DELeTe:ALL
Example	:SOUR:RAD:ARB:DELeTe:ALL
Notes	<p>When in Sequence Analyzer mode and Include Source is Yes, an attempt to delete all files from ARB memory is rejected with an error.</p> <p>When Include Source is No and you attempt to delete all files from ARB memory when the ARB is currently playing a file, all files except the one playing are deleted and an error is generated.</p> <p>If you attempt to delete all files from ARB memory when there are waveform files used in "List Sequencer" on page 2168 and "Sequencer" on page 2168 state is ON, all files except the files currently being used in list sequencer are deleted, and an error is generated.</p> <p>If the ARB is ON and you load a file to ARB memory or delete a file from ARB memory, the playing waveform segment may not keep phase continuity during the ARB memory operation. The waveform will be replayed after the ARB operation is finished.</p>
Initial S/W Revision	A.05.00

Edit Selected Waveform

Allows access to the sub-menus for editing the details of the currently selected waveform segment.

Key Path	Source, Modulation Setup, ARB, Waveform Sequences, Build New Sequence
Notes	No remote command, front panel only.
Initial S/W Revision	A.05.00

Repetitions

Allows you to specify the number of times the currently selected waveform is played within the sequence.

Key Path	Source, Modulation Setup, ARB, Waveform Sequences, Build New Sequence, Edit Selected Waveform
----------	---

Notes	No remote command, SCPI front panel only.
Preset	1
Min	1
Max	65535
Initial S/W Revision	A.05.00

Marker 1

Allows you to enable or disable marker 1 for the currently selected waveform. For a waveform sequence, you can enable and disable markers on a per-segment basis, allowing you to output markers from some waveform segments within the sequence, but not for others.

Key Path	Source, Modulation Setup, ARB, Waveform Sequences, Build New Sequence, Edit Selected Waveform
Notes	No remote command, front panel only.
Preset	Enabled
Range	Enabled Disabled
Initial S/W Revision	A.05.00

Marker 2

Allows you to enable or disable marker 2 for the currently selected waveform. For a waveform sequence, you can enable and disable markers on a per-segment basis, allowing you to output markers from some waveform segments within the sequence, but not for others.

Key Path	Source, Modulation Setup, ARB, Waveform Sequences, Build New Sequence, Edit Selected Waveform
Notes	No remote command, front panel only.
Preset	Enabled
Range	Enabled Disabled
Initial S/W Revision	A.05.00

Marker 3

Allows you to enable or disable marker 3 for the currently selected waveform. For a waveform sequence, you can enable and disable markers on a per-segment basis, allowing you to output markers from some waveform segments within the sequence, but not for others.

Key Path	Source, Modulation Setup, ARB, Waveform Sequences, Build New Sequence, Edit Selected Waveform
----------	---

Notes	No remote command, front panel only.
Preset	Enabled
Range	Enabled Disabled
Initial S/W Revision	A.05.00

Marker 4

Allows you to enable or disable marker 4 for the currently selected waveform. For a waveform sequence, you can enable and disable markers on a per-segment basis, allowing you to output markers from some waveform segments within the sequence, but not for others.

Key Path	Source, Modulation Setup, ARB, Waveform Sequences, Build New Sequence, Edit Selected Waveform
Notes	No remote command, front panel only.
Preset	Enabled
Range	Enabled Disabled
Initial S/W Revision	A.05.00

Delete Segment

Allows you to delete the selected segment from the waveform sequence.

Key Path	Source, Modulation Setup, ARB, Waveform Sequences, Build New Sequence
Notes	No remote command, front panel only.
Initial S/W Revision	A.05.00

Save Sequence...

Pressing this key displays the “Save As” dialog. The sequence name is passed to the save as dialog to use as the filename for saving, and the directory the save as dialog will open into is the default waveform directory.

Key Path	Source, Modulation Setup, ARB, Waveform Sequences, Build New Sequence
Initial S/W Revision	A.05.00

Edit Selected Sequence

Allows access to the sub-menus for editing the sequence currently selected within the Waveform Sequence List view. Pressing this key changes the central view area to display the Waveform Sequence Creation and Editing view.

Key Path	Source, Modulation Setup, ARB, Waveform Sequences
Notes	No remote command, front panel only.
Initial S/W Revision	A.05.00

Current Directory...

Allows you to change the currently selected directory on the hard disk. Pressing this key opens a standard windows change directory dialog and allows you to select the new directory of interest.

Key Path	Source, Modulation Setup, ARB, Waveform Sequences
Notes	No remote command, front panel only.
Initial S/W Revision	A.05.00

Waveform Utilities

Allows you access to the waveform utilities sub-menus.

Key Path	Source, Modulation Setup, ARB
Initial S/W Revision	A.05.00

Multi-Pack Licenses

Allows you access to the Multi - Pack License sub-menus. Pressing this key also changes the central view area to display the Multi -Pack License Management view.

On modular instrument like E6630A or E6640A, multi-pack license operations are only allowed on the default module, i.e. "Left" module for E6630A or "TRX1" module for E6640A.

Key Path	Source, Modulation Setup, ARB, Waveform Utilities
Dependencies	This key is only available if there is at least one Multi-pack license installed on the instrument.
Initial S/W Revision	A.05.00

Add Waveform

Pressing this key accesses the Add Waveform sub-menu. It also changes the central display area to display the Multi-Pack License Waveform Add view.

Key Path	Source, Modulation Setup, ARB, Waveform Utilities, Multi-Pack Licenses
Dependencies	This key is only available if there is at least one slot available within at least one multi-pack license.
Initial S/W Revision	A.05.00

Add Waveform

Allows you to add the currently selected waveform segment to a multi-pack license. The new waveform is added to the next available slot regardless of which slot was selected on the Multi-Pack License Management view.

Key Path	Source, Modulation Setup, ARB, Waveform Utilities, Multi-Pack Licenses, Add Waveform
Remote Command	:SYSTem:LKEY:WAVeform:ADD <string> or :SYSTem:LICense[:FPACK]:WAVeform:ADD <string>
Example	SYST:LKEY:WAV:ADD "mywaveform.wfm" or SYST:LIC:WAV:ADD "mywaveform.wfm"
Notes	The second SCPI :SYSTem:LICense[:FPACK]:WAVeform:ADD is provided to be consistent with the style of Keysight signal sources. You can use either one of them. Since adding a waveform segment to a Multi-Pack license causes the license slot to enter the trial period of only 48 hours, pressing this key causes a confirmation dialog to be displayed to ensure you do want to add the waveform segment to the Multi-Pack. If you attempt to license a waveform that is already licensed using another slot an error is generated. .
Dependencies	This key is only available if the currently selected file is a secure waveform requiring a license, and there is at least one slot available within at least one multi-pack license. If the waveform highlighted is a secure waveform, but is already licensed, this key will be unavailable.
Initial S/W Revision	A.05.00

Segments on Hard Disk

Allows you access to the sub-menus for loading waveform segments from the hard disk into ARB memory. The default directory is: D: varb.

Pressing this key changes the current view to the Waveform Management View.

Key Path	Source, Modulation Setup, ARB, Select Waveform
Initial S/W Revision	A.05.00

Load Segment To ARB Memory

Allows you to load the selected file into ARB memory. On the front panel you select the file for loading to the ARB memory by highlighting the desired file in the list. Using the SCPI command, you specify the file name on the HDD.

"NVWFM" (none-volatile storage) MSUS (Mass Storage Unit Specifier) is supported in the memory subsystem because the ARB memory cannot be accessed directly. Therefore, files must be downloaded to the instrument hard disk and then loaded into the ARB memory. "NVWFM" MSUS will be mapped to the

default directory D: VARB. The SCPI command supports using either “NVWFM” MSUS or specifying a full path. For more information, see Memory Subsystem (Remote Command Only).

If a file of the same name already exists within ARB memory, it is overwritten. If you wish to load two segments of the same name, you must rename one of the segments before loading it into ARB memory. To rename a segment, you can either use Windows File Explorer, or the :MMEMory:COPI command.

NOTE: When a waveform file is loaded to ARB memory, burst timing adjustments are made automatically, based on whether or not a Multiport Adapter is connected to the test set and powered on. If the connection/power status of the Multiport Adapter is changed after a waveform file has been loaded, it needs to be loaded again.

Key Path	Source, Modulation Setup, ARB, Select Waveform, Segments on Hard Disk
Remote Command	:SOURce:RADio:ARB:LOAD <string>
Example	:SOUR:RAD:ARB:LOAD "D: VARB\testwaveform.bin" or :SOUR:RAD:ARB:LOAD "NVWFM:testwaveform.bin"
Notes	<p>Because loading the file involves a delay of unpredictable length, this command should be followed by the query *OPC?, which holds off subsequent commands until the loading operating is complete.</p> <p><string> – specifies the path name of the file to load from the HDD into ARB memory. It could be a <full path + filename>, or <“NVWFM” MSUS + colon + filename>.</p> <p>When in Sequence Analyzer mode, and Include Source is Yes, an attempt to load a file to ARB memory will be rejected with an error.</p> <p>When Include Source is No and if there is insufficient free ARB memory to load the selected waveform, an error is generated. .</p> <p>If you specify a file over SCPI, but the file is not at the specified location, an error is generated.</p> <p>If you try to load a waveform file but the file contains less than 500 IQ samples, an error is generated.</p> <p>If you try to load a Signal Studio waveform “*.wfm” which contains invalid waveform header, an error is generated.</p> <p>If the ARB is ON when you load a file to ARB memory or delete a file from ARB memory, the playing waveform segment may not keep phase continuity during the ARB memory operation. The waveform will be replayed after the ARB operation is finished.</p> <p>ARB can be loaded into ARB memory even required licenses do not present on the instrument. In this case, a GUI only warning message –800, “Operation complete; Loaded <filename> successfully, but no license <required licenses> installed”. User can install required licenses according to <required licenses> string to license it, or multi-pack license it.</p>
Initial S/W Revision	A.05.00

Load All To ARB Memory

Allows you to load all the segment files within the currently selected directory into ARB memory. If a file of the same name already exists within ARB memory, it is overwritten. If you wish to load two segments of the same name, you must rename one of the segments before loading it into ARB memory. To rename a segment, you can either use Windows File Explorer, or the :MEMory:COPI command.

NOTE: When a waveform file is loaded to ARB memory, burst timing adjustments are made automatically, based on whether or not a Multiport Adapter is connected to the test set and powered on. If the

connection/power status of the Multiport Adapter is changed after a waveform file has been loaded, it needs to be loaded again.

Key Path	Source, Modulation Setup, ARB, Select Waveform, Segments on Hard Disk
Remote Command	:SOURce:RADio:ARB:LOAD:ALL <string>
Example	:SOUR:RAD:ARB:LOAD:ALL "D: varb"
Notes	<p><string> - specifies the directory on the HDD to load the files into ARB memory from.</p> <p>When in Sequence Analyzer mode, and Include Source is Yes, an attempt to load all files from a directory to ARB memory is rejected with an error.</p> <p>When Include Source is No and there is insufficient free ARB memory to load all the waveforms, when the ARB memory is full, the copy ceases, and an error is generated.</p> <p>If you specify a directory over SCPI, but the directory does not exist, an error is generated.</p> <p>If the ARB is ON, a user then loads or deletes file to ARB memory, the playing waveform segment may not keep phase continuity during the ARB memory operation. The waveform will be replayed after the ARB operation is finished.</p>
Initial S/W Revision	A.05.00

Change Directory...

Allows you to change the currently selected directory on the hard disk. Pressing this key opens a standard windows change directory dialog allowing you to select the new directory of interest.

The current directory is used for manually loading waveform segments into ARB memory for playback, and as a search location for waveform segments that are required to be loaded into ARB memory for playback of a waveform sequence or a list sequence.

Key Path	Source, Modulation Setup, ARB, Select Waveform, Segments on Hard Disk
Notes	No remote command, SCPIfront panel only.
Initial S/W Revision	A.05.00

Default Directory...

Allows you to change the default directory. It is used as a search location for waveform segments that are required to be loaded into ARB memory for playback of a waveform sequence, and as a search location for selecting waveforms using SCPI.

Key Path	Source, Modulation Setup, ARB, Select Waveform, Segments on Hard Disk
Remote Command	:SOURce:RADio:ARB:DEFault:DIRectory <string> :SOURce:RADio:ARB: DEFault:DIRectory?
Example	:SOUR:RAD:ARB:DEF:DIR "D:\ArbFiles" :SOUR:RAD:ARB:DEF:DIR?
State Saved	Persistent, survives a power cycle and a preset but not saved in the instrument state
Initial S/W Revision	A.05.00

Replace Waveform

Pressing this key accesses the Replace Waveform submenu. It also changes the central display area to display the Multi-Pack License Waveform Add view.

Key Path	Source, Modulation Setup, ARB, Waveform Utilities, Multi-Pack Licenses
Dependencies	This key is only available if the currently selected slot is in the trial state.
Initial S/W Revision	A.05.00

Replace Waveform

Allows you to replace the waveform in the currently selected slot with the waveform currently selected in the Multi-Pack License Waveform Add view.

Key Path	Source, Modulation Setup, ARB, Waveform Utilities, Multi-Pack Licenses, Replace Waveform
Remote Command	:SYSTem:LKEY:WAVeform:REPLace <int>, <string> or :SYSTem:LICense[:FPACK]:WAVeform:REPLace <int>, <string>
Example	SYST:LKEY:WAV:REPL 1, "myotherwaveform.wfm" or :SYST:LIC:WAV:REPL 1, "myotherwaveform.wfm"
Notes	The second SCPI :SYSTem:LICense[:FPACK]:WAVeform:REPLace is provided to be consistent with the style of Keysight signal sources. You can use either one of them. If you attempt to license a waveform that is already licensed using another slot an error is generated. Waveform slot number <int> is positive. If you attempt to input a slot number less than or equals 0, an error is generated.
Initial S/W Revision	A.05.00

Clear Waveform from Slot

Allows you to clear the waveform from the selected slot.

Key Path	Source, Modulation Setup, ARB, Waveform Utilities, Multi-Pack Licenses
Remote Command	:SYSTem:LKEY:WAVeform:CLEar <int> or :SYSTem:LICense[:FPACK]:WAVeform:CLEar <int>
Example	SYST:LKEY:WAV:CLE 1 or :SYST:LIC:WAV:CLE 1
Notes	The second SCPI :SYSTem:LICense[:FPACK]:WAVeform:CLEar is provided to be consistent with the style of Keysight signal sources. You can use either one of them. Waveform slot number <int> is positive. If you attempt to input a slot number less than or equals 0, an

error is generated.

Dependencies	This key is only available if the currently selected slot is in the trial state.
Initial S/W Revision	A.05.00

Lock Waveform in Slot

If the selected slot is in the trial state or the lock required state, the waveform that occupies the slot is locked and permanently licensed.

Key Path	Source, Modulation Setup, ARB, Waveform Utilities, Multi-Pack Licenses
----------	--

Remote Command	:SYSTem:LKEY:WAVeform:LOCK <int> or :SYSTem:LICense[:FPACK]:WAVeform:LOCK <int>
----------------	---

Example	SYST:LKEY:WAV:LOCK 1 or SYST:LIC:WAV:LOCK 1
---------	---

Notes	The second SCPI :SYSTem:LICense[:FPACK]:WAVeform:LOCK is provided to be consistent with the style of Keysight signal sources. You can use either one of them. Waveform slot number <int> is positive. If you attempt to input a slot number less than or equals 0, an error is generated.
-------	--

Dependencies	This key is only available if the currently selected slot is in the trial state or the lock required state.
Initial S/W Revision	A.05.00

Marker Utilities

Allows access to the marker utilities sub-menus.

Key Path	Source, Modulation Setup, ARB
Initial S/W Revision	A.05.00

Marker Polarity

Allows access to the marker polarity sub-menu, which allows you to specify the polarity for the four markers. For a positive polarity, the marker signal is high during the marker points. For a negative marker polarity, the marker signal is high during the period of no marker points.

Key Path	Source, Modulation Setup, ARB, Marker Utilities
Initial S/W Revision	A.05.00

Mkr 1 Polarity

Allows you to set the polarity of marker 1.

Key Path	Source, Modulation Setup, ARB, Marker Utilities, Marker Polarity
Remote Command	:SOURce:RADio:ARB:MPOLarity:MARKer1 POSitive NEGative :SOURce:RADio:ARB:MPOLarity:MARKer1?
Example	:SOUR:RAD:ARB:MPOL:MARK1 NEG
Dependencies	When a new waveform is selected for playback the settings contained within the associated waveform header file are applied to the ARB. The marker polarity is one of the values stored within the header file. If the newly selected waveform file has an associated header file, the marker polarity is updated with the value from the header file. The marker polarity will remain unchanged if the newly selected waveform does not have an associated header file.
Preset	Pos
Range	Neg Pos
Initial S/W Revision	A.05.00

Mkr 2 Polarity

Allows you to set the polarity of marker 2.

Key Path	Source, Modulation Setup, ARB, Marker Utilities, Marker Polarity
Remote Command	:SOURce:RADio:ARB:MPOLarity:MARKer2 POSitive NEGative :SOURce:RADio:ARB:MPOLarity:MARKer2?
Example	:SOUR:RAD:ARB:MPOL:MARK2 NEG
Dependencies	When a new waveform is selected for playback the settings contained within the associated waveform header file are applied to the ARB. The marker polarity is one of the values stored within the header file. If the newly selected waveform file has an associated header file, the marker polarity is updated with the value from the header file. The marker polarity will remain unchanged if the newly selected waveform does not have an associated header file.
Preset	Pos
Range	Neg Pos
Initial S/W Revision	A.05.00

Mkr 3 Polarity

Allows you to set the polarity of marker 3.

Key Path	Source, Modulation Setup, ARB, Marker Utilities, Marker Polarity
Remote Command	:SOURce:RADio:ARB:MPOLarity:MARKer3 POSitive NEGative :SOURce:RADio:ARB:MPOLarity:MARKer3?
Example	:SOUR:RAD:ARB:MPOL:MARK3 NEG
Dependencies	When a new waveform is selected for playback the settings contained within the associated

	waveform header file are applied to the ARB. The marker polarity is one of the values stored within the header file. If the newly selected waveform file has an associated header file, the marker polarity is updated with the value from the header file. The marker polarity will remain unchanged if the newly selected waveform does not have an associated header file.
Preset	Pos
Range	Neg Pos
Initial S/W Revision	A.05.00

Mkr 4 Polarity

Allows you to set the polarity of marker 4.

Key Path	Source, Modulation Setup, ARB, Marker Utilities, Marker Polarity
Remote Command	:SOURce:RADio:ARB:MPOLarity:MARKer4 POSitive NEGative :SOURce:RADio:ARB:MPOLarity:MARKer4?
Example	:SOUR:RAD:ARB:MPOL:MARK4 NEG
Dependencies	When a new waveform is selected for playback the settings contained within the associated waveform header file are applied to the ARB. The marker polarity is one of the values stored within the header file. If the newly selected waveform file has an associated header file, the marker polarity is updated with the value from the header file. The marker polarity will remain unchanged if the newly selected waveform does not have an associated header file.
Preset	Pos
Range	Neg Pos
Initial S/W Revision	A.05.00

Marker Routing

Allows access to the marker routing sub-menus, which allow you to specify where the marker events are routed. It should be noted that the markers can also be routed to Trigger 1 Out and Trigger 2 Out, however this must be set up using the menus accessed by pressing the “Trigger” hard key.

Key Path	Source, Modulation Setup, ARB, Marker Utilities
Initial S/W Revision	A.05.00

Pulse/RF Blank

Allows you to select which marker is used for the pulse/RF blanking function. The pulse/RF blanking function blanks the RF when the marker signal goes low. The marker polarity determines when the marker signal is high. For a positive polarity, this is during the marker points. For a negative polarity, this is when there are no marker points.

Marker points should be set before using this function. Enabling this function without setting marker points may create a continuous low or high signal, dependant on the marker polarity. This causes either no RF output, or a continuous RF output.

Key Path	Source, Modulation Setup, ARB, Marker Utilities, Marker Routing
Remote Command	:SOURce:RADio:ARB:MDEStination:PULSe NONE M1 M2 M3 M4 :SOURce:RADio:ARB:MDEStination:PULSe?
Example	:SOUR:RAD:ARB:MDES:PULS NONE
Dependencies	When a new waveform is selected for playback the settings contained within the associated waveform header file are applied to the ARB. The pulse/RF blanking setting is one of the values stored within the header file. If the newly selected waveform file has an associated header file, the pulse/RF blanking setting is updated with the value from the header file. The pulse/RF blanking setting will remain unchanged if the newly selected waveform does not have an associated header file.
Range	None M1 M2 M3 M4
Initial S/W Revision	A.05.00

None

Sets no marker to be used for the pulse/RF blanking function, essentially turning the RF blanking function off.

Key Path	Source, Modulation Setup, ARB, Marker Utilities, Marker Routing, Pulse/RF Blank
Example	:SOUR:RAD:ARB:MDES:PULS NONE
Initial S/W Revision	A.05.00

Marker 1

Sets marker 1 to be used for the pulse/RF blanking function.

Key Path	Source, Modulation Setup, ARB, Marker Utilities, Marker Routing, Pulse/RF Blank
Example	:SOUR:RAD:ARB:MDES:PULS M1
Initial S/W Revision	A.05.00

Marker 2

Sets marker 2 to be used for the pulse/RF blanking function.

Key Path	Source, Modulation Setup, ARB, Marker Utilities, Marker Routing, Pulse/RF Blank
Example	:SOUR:RAD:ARB:MDES:PULS M2
Initial S/W Revision	A.05.00

Marker 3

Sets marker 3 to be used for the pulse/RF blanking function.

Key Path	Source, Modulation Setup, ARB, Marker Utilities, Marker Routing, Pulse/RF Blank
Example	:SOUR:RAD:ARB:MDES:PULS M3
Initial S/W Revision	A.05.00

Marker 4

Sets marker 4 to be used for the pulse/RF blanking function.

Key Path	Source, Modulation Setup, ARB, Marker Utilities, Marker Routing, Pulse/RF Blank
Example	:SOUR:RAD:ARB:MDES:PULS M4
Initial S/W Revision	A.05.00

ALC Hold

Allows you to specify which marker is routed for use within the ALC hold function. The ALC hold marker function holds the ALC circuitry at the average value of the sample points set by the marker.

The ALC hold function operates during the low periods of the marker signal. The marker polarity determines when the marker signal is high. For positive polarity, this is during the marker points. For a negative polarity, this is when there are no marker points.

Key Path	Source, Modulation Setup, ARB, Marker Utilities, Marker Routing
Remote Command	:SOURce:RADio:ARB:MDEStination:ALCHold NONE M1 M2 M3 M4 :SOURce:RADio:ARB:MDEStination:ALCHold?
Example	:SOUR:RAD:ARB:MDES:ALCH NONE
Dependencies	When a new waveform is selected for playback the settings contained within the associated waveform header file are applied to the ARB. The ALC hold setting is one of the values stored within the header file. If the newly selected waveform file has an associated header file, the ALC hold setting is updated with the value from the header file. The ALC hold setting will remain unchanged if the newly selected waveform does not have an associated header file.
Range	None M1 M2 M3 M4
Initial S/W Revision	A.05.00

None

Sets no marker to be used for the ALC hold function, essentially turning the ALC hold function off.

Key Path	Source, Modulation Setup, ARB, Marker Utilities, Marker Routing, ALC Hold
Example	:SOUR:RAD:ARB:MDES:PULS NONE
Initial S/W Revision	A.05.00

Marker 1

Sets marker 1 to be used for the ALC hold function.

Key Path	Source, Modulation Setup, ARB, Marker Utilities, Marker Routing, ALC Hold
Example	:SOUR:RAD:ARB:MDES:PULS M1
Initial S/W Revision	A.05.00

Marker 2

Sets marker 2 to be used for the ALC hold function.

Key Path	Source, Modulation Setup, ARB, Marker Utilities, Marker Routing, ALC Hold
Example	:SOUR:RAD:ARB:MDES:PULS M2
Initial S/W Revision	A.05.00

Marker 3

Sets marker 3 to be used for the ALC hold function.

Key Path	Source, Modulation Setup, ARB, Marker Utilities, Marker Routing, ALC Hold
Example	:SOUR:RAD:ARB:MDES:PULS M3
Initial S/W Revision	A.05.00

Marker 4

Sets marker 4 to be used for the ALC hold function.

Key Path	Source, Modulation Setup, ARB, Marker Utilities, Marker Routing, ALC Hold
Example	:SOUR:RAD:ARB:MDES:PULS M4
Initial S/W Revision	A.05.00

Header Utilities

Allows access to the header utilities sub-menu. Pressing this key also causes the central display area to change to display the File Header Information view.

Key Path	Source, Modulation Setup, ARB
Dependencies	This key is only available if there is currently a waveform selected for playback. If no waveform is selected, the key is grayed out.
Initial S/W Revision	A.05.00

Clear Header

Allows you to clear the header information from the file header associated with the currently selected waveform.

Key Path	Source, Modulation Setup, ARB, Header Utilities
Remote Command	:SOURce:RADio:ARB:HEADer:CLEar
Example	:SOUR:RAD:ARB:HEAD:CLE
Notes	Attempting to clear the header details via SCPI when no waveform was selected for playback will generate an error.
Initial S/W Revision	A.05.00

Save Setup To Header

Allows you to save new file header information details to the file.

Key Path	Source, Modulation Setup, ARB, Header Utilities
Remote Command	:SOURce:RADio:ARB:HEADer:SAVE
Example	:SOUR:RAD:ARB:HEAD:SAVE
Notes	Attempting to save the header details via SCPI when no waveform was selected for playback will generate an error.
Initial S/W Revision	A.05.00

AM

Allows access to the menu for configuring the Amplitude Modulation.

Key Path	Source, Modulation Setup
Initial S/W Revision	A.05.00

AM

Enables or disables the amplitude modulation.

Turning AM on when another modulation format is already on results in the previous modulation format being turned off and the generation of an error.

Key Path	Source, Modulation Setup, AM
Remote Command	:SOURce:AM:STATe :SOURce:AM:STATe?
Example	:SOUR:AM:STAT OFF

Preset	Off
Range	On Off
Initial S/W Revision	A.05.00

AM Depth

Allows you to set the amplitude modulation depth in percent.

Key Path	Source, Modulation Setup, AM
Remote Command	:SOURce:AM[:DEPTh] [:LINear] :SOURce:AM[:DEPTh] [:LINear]?
Example	:SOUR:AM 0.1
Preset	0.1 %
Min	0.1 %
Max	95.0 %
Initial S/W Revision	A.05.00

AM Rate

Allows you to set the internal amplitude modulation rate.

Key Path	Source, Modulation Setup, AM
Remote Command	:SOURce:AM:INTernal:FREQuency :SOURce:AM:INTernal:FREQuency?
Example	:SOUR:AM:INT:FREQ 40.0 Hz
Preset	400.0 Hz
Min	10 Hz
Max	40 kHz
Initial S/W Revision	A.05.00

FM

Allows access to the menu for configuring the frequency modulation.

Key Path	Source, Modulation Setup
Initial S/W Revision	A.05.00

FM

Enables or disables the frequency modulation.

Turning FM on when another modulation format is already on results in the previous modulation format being turned off and the generation of an error.

Key Path	Source, Modulation Setup, FM
Remote Command	:SOURce:FM:STATe :SOURce:FM:STATe?
Example	:SOUR:FM:STAT OFF
Preset	Off
Range	On Off
Initial S/W Revision	A.05.00

FM Deviation

Allows you to set the frequency modulation deviation.

Key Path	Source, Modulation Setup, FM
Remote Command	:SOURce:FM[:DEVIation] :SOURce:FM[:DEVIation]?
Example	:SOUR:FM 1.00 kHz
Preset	1.00 Hz
Min	1.00 Hz
Max	100.00 kHz
Initial S/W Revision	A.05.00

FM Rate

Allows you to set the internal frequency modulation rate.

Key Path	Source, Modulation Setup, FM
Remote Command	:SOURce:FM:INTernal:FREQuency :SOURce:FM:INTernal:FREQuency?
Example	:SOUR:FM:INT:FREQ 40.0 Hz
Preset	400.0 Hz
Min	10 Hz
Max	40 kHz
Initial S/W Revision	A.05.00

PM

Allows access to the menu for configuring the phase modulation.

Key Path	Source, Modulation Setup
Initial S/W Revision	A.05.00

PM

Enables or disables the phase modulation.

Turning PM on when another modulation format is already on results in the previous modulation format being turned off and the generation of an error.

Key Path	Source, Modulation Setup, PM
Remote Command	:SOURce:PM:STATe :SOURce:PM:STATe?
Example	:SOUR:PM:STAT OFF
Preset	Off
Range	On Off
Initial S/W Revision	A.05.00

PM Deviation

Allows you to set the phase modulation deviation.

Key Path	Source, Modulation Setup, PM
Remote Command	:SOURce:PM[:DEViation] :SOURce:PM[:DEViation]?
Example	:SOUR:PM 1.00 rad
Preset	0.1 rad
Min	0.1 rad
Max	20.0 rad
Initial S/W Revision	A.05.00

PM Rate

Allows you to set the internal phase modulation rate.

Key Path	Source, Modulation Setup, PM
Remote Command	:SOURce:PM:INTernal:FREQuency :SOURce:PM:INTernal:FREQuency?

Example	:SOUR:PM:INT:FREQ 40.0 Hz
Preset	400.0 Hz
Min	10 Hz
Max	40 kHz
Initial S/W Revision	A.05.00

List Sequencer

Allows you access to the sub-menus for configuring the list sequencer.

List sequences allows you to enter frequencies and amplitudes at unequal intervals in nonlinear ascending, descending or random order. Each step within the list can also include its own waveform file for playback, step duration, trigger event and trigger output.

The complexities involved in configuring the list sequencer do not lend itself to manual configuration; hence the manual configuration for this feature is limited. For easier configuration of the list sequencer, it is recommended that you use either SCPI or load a tab delimited file containing the setup parameters in a tabular form. The details of the SCPI for configuring the list sequencer can be found in Step Configuration (Remote Command Only).

Once the List Sequencer has been configured using the front panel, SCPI, or loading in a tab delimited file, the sequence must be initiated using the front panel Initiate Sequence key or the corresponding SCPI command.

Key Path	Source
Initial S/W Revision	A.05.00

Sequencer

Allows you to set the state of the list sequencer. When the list sequencer is on, the source is outputting the sequence defined by the sequencer. When the list sequencer is off, the source outputs a single waveform segment or sequence (independent mode) at a single frequency and amplitude.

Key Path	Source, List Sequencer
Remote Command	:SOURce:LIST[:STATe] ON OFF 1 0 :SOURce:LIST[:STATe]?
Example	:SOUR:LIST OFF
Notes	When the sequencer is set to ON, the list sequencer controls the output of the source.
Couplings	When in Sequence Analyzer mode and the list sequencer state is Off, Include Source is forced to No, and the Include Source key is grayed out. When in Sequence Analyzer mode and the list sequencer state is On, Include Source is available to set. And, an ARB memory related operation, like load or delete will be rejected.

Preset	Off
Range	On Off
Initial S/W Revision	A.05.00

Initiate Sequence

Pressing this key arms the sequence for single execution. Once the sequence is armed the source begins the sequence as soon as the trigger is received. If the trigger is set to Free Run, the sequence starts immediately.

Key Path	Source, List Sequencer
Remote Command	:SOURce:LIST:TRIGger [:IMMediate]
Example	:SOUR:LIST:TRIG
Notes	<p>When in Sequence Analyzer mode and Include Source is Yes, the Initiate list sequencer operation is rejected, and the key is grayed out, since source list sequence request is sent to physics via Parallel batch by sequence analyzer.</p> <p>If the file needed by the sequencer is not already in ARB memory, the sequence cannot be initiated and an error will be generated.</p> <p>There is a blocking SCPI query which can be used to query if source list sequence being initiated successfully or not. (see Query List Sequence Initiation Armed Status (Remote Command Only) Query Source List Sequence Armed Status)</p>
Dependencies	Under the Sequence Analyzer Mode, if Meas Setup->Include Source is set to YES, Source->List Sequencer->Initiate Sequence is disabled.
Initial S/W Revision	A.05.00

List Sequencer Setup

Allows you access to the list sequencer setup menus.

Key Path	Source, List Sequencer
----------	------------------------

Number of Steps

Allows you to specify the number of steps within the list sequence.

Key Path	Source, List Sequencer, List Sequencer Setup
Remote Command	:SOURce:LIST:NUMBer:STEPs <integer> :SOURce:LIST:NUMBer:STEPs?
Example	:SOUR:LIST:NUMB:STEP 1
Notes	Increasing the number of steps creates additional steps at the end of the list, with all the settings

	within the steps set to their default values. Decreasing the number of steps removes steps from the end of the list. The settings within the removed steps are not reset. This means that increasing the number of steps again would allow you to retrieve these steps.
Dependencies	The Step Count parameter is increased or decreased when you insert or delete a point from within the GUI interface to the sequencer.
Preset	1
Min	1
Max	1000
Initial S/W Revision	A.05.00

Current Step

Allows you to select the step number you wish to view or edit.

Key Path	Source, List Sequencer, List Sequencer Setup
Notes	No remote command, front panel only.
Preset	1
Min	1
Max	Step Count
Initial S/W Revision	A.05.00

Insert Step Before

Allows you to insert a new step, containing default values, before the currently selected step. Inserting a step will automatically increase the Step Count parameter by 1. If sequence already reaches upper limit of 1000 steps, then insert more step will be rejected and popup error -221, "Setting Conflict; Cannot insert more steps, maximum number of steps reached"

Key Path	Source, List Sequencer, List Sequencer Setup
Notes	No remote command, front panel only. If the list already contains the maximum limit of 1000 steps, no operation will be made after pressing this key.
Initial S/W Revision	A.05.00

Delete Step

Allows you to delete the current step. Deleting a step will automatically decrease the Step Count parameter by 1. If sequence only has one step left, delete step will be rejected and popup error -221, "Setting conflict; Cannot delete current step, minimum number of steps reached"

Key Path	Source, List Sequencer, List Sequencer Setup
Notes	No remote command, Front Panel key only. If the list already contains the minimum limit of 1 step, no operation will be made after pressing this key
Initial S/W Revision	A.05.00

Clear List

Allows you to clear the list. Clearing the list sets the number of steps to the default value of 1 and sets the parameters for the only step to their default values.

Key Path	Source, List Sequencer, List Sequencer Setup
Initial S/W Revision	A.05.00

Step Trigger

Allows access to the sub-menu for selecting the trigger input for the current step.

Key Path	Source, List Sequencer, List Sequencer Setup
Remote Command	:SOURCE:LIST:STEP[1] 2 3...1000:SETup:INPut:TRIGger IMMEDIATE INTERNAL EXTERNAL2 KEY BUS EXTERNAL4 :SOURCE:LIST:STEP[1] 2 3...1000:SETup:INPut:TRIGger?
Example	:SOUR:LIST:STEP2:SET:INP:TRIG BUS :SOUR:LIST:STEP2:SET:INP:TRIG?
Notes	SCPI is supported after A.09.40
Preset	Free Run
Range	Free Run Internal Manual (Trigger Key) Bus External 2 EXTERNAL4
Initial S/W Revision	A.05.00

Free Run

Sets the trigger input for the current step to Free Run.

Key Path	Source, List Sequencer, List Sequencer Setup, Step Trigger
Example	:SOUR:LIST:STEP2:SET:INP:TRIG IMM
Notes	SCPI is supported after A.09.40
Initial S/W Revision	A.05.00

Internal

Sets the trigger input for the current step to Internal.

Key Path	Source, List Sequencer, List Sequencer Setup, Step Trigger
Example	:SOUR:LIST:STEP2:SET:INP:TRIG INT
Notes	SCPI is supported after A.09.40
Initial S/W Revision	A.05.00

Manual (Trigger Key)

Sets the trigger input for the current step to Manual (Trigger Key). Any step in the sequence set to Manual will cause the sequence execution to stop until the manual trigger key is pressed. Sending the Bus Trigger SCPI command will have no effect. At any point in the sequence where the list sequencer is paused waiting for a software trigger, a pop up dialog is displayed until the trigger event occurs.

Key Path	Source, List Sequencer, List Sequencer Setup, Step Trigger
Example	:SOUR:LIST:STEP2:SET:INP:TRIG KEY
Notes	SCPI is supported after A.09.40
Initial S/W Revision	A.05.00

Bus

Sets the trigger input for the current step to Bus. Any step in the sequence set to Bus will cause the sequence execution to stop until the Bus Trigger SCPI command is sent. Pressing the manual trigger key has no effect. At any point in the sequence where the list sequencer is paused waiting for a software trigger, a pop up dialog is displayed until the trigger event occurs.

Key Path	Source, List Sequencer, List Sequencer Setup, Step Trigger
Example	:SOUR:LIST:STEP2:SET:INP:TRIG BUS
Notes	SCPI is supported after A.09.40
Initial S/W Revision	A.05.00

External 2

Sets the trigger input for the current step to External 2.

Key Path	Source, List Sequencer, List Sequencer Setup, Step Trigger
Example	:SOUR:LIST:STEP2:SET:INP:TRIG EXT2
Notes	SCPI is supported after A.09.40
Notes	Note: When on E6640A, trigger 2 is a bi-directional trigger port. So when trigger 2 has been configured as OUTPUT type, choosing External 2 as the input trigger for the current step will generate error.
Initial S/W Revision	A.05.00

Transition Time

Allows you to specify the transition time for the current step.

The transition time is the amount of time allowed for the source to settle at the current frequency or amplitude value.

Transition Time should not be taken as additional time before or inside the Step Duration. You can set a value for the settling time to allow the source output frequency or amplitude to become stable. Make sure that during this period of time, you do not use the source output signal.

The following table lists recommended values for appropriate settling times to allow for changes within the source.

Value Changed	Recommended Transition Time
Frequency	500 μ s
Amplitude	100 μ s to within 0.1 dB 20 μ s to within 1.0 dB

If the Transition Time value is shorter than the time necessary for the hardware to settle and a List Sequence is initiated, a **warning** is generated.

If the Transition Time value is longer than the Step Duration, an error is generated when initiating a source list sequence. For source list sequence, transition time is included in the step duration length. If the Transition Time value is longer than the Step Duration Time, the real step duration length is extended to equal the transition time and cause a timing shift.

Key Path	Source, List Sequencer, List Sequencer Setup
Remote Command	:SOURce:LIST:STEP[1] 2 3...1000:SETup:TRANSition:TIME <time> :SOURce:LIST:STEP[1] 2 3...1000:SETup:TRANSition:TIME?
Example	:SOUR:LIST:STEP2:SET:TRAN:TIME 1ms :SOUR:LIST:STEP2:SET:TRAN:TIME?
Notes	SCPI is supported after A.09.40
Preset	1.0 ms
Min	0.0 ms
Max	4.0 ks
Initial S/W Revision	A.05.00

Radio Setup

Allows you access to the sub-menus for setting up the radio standard, band, and radio band link direction for the current step.

Key Path	Source, List Sequencer, List Sequencer Setup
Notes	No remote command, front panel only.

Initial S/W Revision	A.05.00
----------------------	---------

Radio Standard

Allows access to the sub-menus for selecting the radio standard and the associated radio band for use in the current step.

Key Path	Source, List Sequencer, List Sequencer Setup, Radio Setup
Remote Command	:SOURCE:LIST:STEP[1] 2 3...1000:SETup:RADio:BAND NONE PGSM EGSM RGSM DCS1800 PCS1900 TGSM810 GSM450 GSM480 GSM700 GSM850 BANDI BANDII BANDIII BANDIV BANDV BANDVI BANDVII BANDVIII BANDIX BANDX BANDXI BANDXII BANDXIII BANDXIV BANDXIX USCELL USPCS JAPAN KOREAN NMT IMT2K UPPER SECOND PAMR400 PAMR800 IMTEXT PCS1DOT9G AWS US2DOT5G PUBLIC LOWER NONE BAND1 BAND2 BAND3 BAND4 BAND5 BAND6 BAND7 BAND8 BAND10 BAND11 BAND12 BAND13 BAND14 BAND17 BAND18 BAND19 BAND20 BAND21 BAND24 BAND25 BAND26 BAND27 BAND28 BAND29 BAND30 BAND31 BAND33 BAND34 BAND35 BAND36 BAND37 BAND38 BAND39 BAND40 BAND41 BAND42 BAND43 BAND44 BANDA BANDB BANDC BANDD BANDE BANDF :SOURCE:LIST:STEP[1] 2 3...1000:SETup: RADio:BAND?
Example	:SOUR:LIST:STEP2:SET:RAD:BAND PGSM :SOUR:LIST:STEP2:SET:RAD:BAND?
Notes	SCPI is supported after A.09.40
Initial S/W Revision	A.05.00

None

Selects no radio standard for use on the current step.

Key Path	Source, List Sequencer, List Sequencer Setup, Radio Setup, Radio Standard
Example	:SOUR:LIST:STEP2:SET:RAD:BAND NONE
Notes	SCPI is supported after A.09.40
Initial S/W Revision	A.05.00

GSM/EDGE

Pressing this key once selects GSM/EDGE as the radio standard and the current GSM/EDGE band as the active channel band. Pressing this key again allows access to the sub-menus for selecting a different GSM/EDGE band.

Key Path	Source, List Sequencer, List Sequencer Setup, Radio Setup, Radio Standard
Initial S/W Revision	A.05.00

P-GSM

Selects P-GSM as the band for the current step.

Key Path	Source, List Sequencer, List Sequencer Setup, Radio Setup, Radio Standard, GSM/EDGE
Initial S/W Revision	A.05.00

E-GSM

Selects E-GSM as the band for the current step.

Key Path	Source, List Sequencer, List Sequencer Setup, Radio Setup, Radio Standard, GSM/EDGE
Initial S/W Revision	A.05.00

R-GSM

Selects R-GSM as the band for the current step.

Key Path	Source, List Sequencer, List Sequencer Setup, Radio Setup, Radio Standard, GSM/EDGE
Initial S/W Revision	A.05.00

DCS 1800

Selects DCS 1800 as the band for the current step.

Key Path	Source, List Sequencer, List Sequencer Setup, Radio Setup, Radio Standard, GSM/EDGE
Initial S/W Revision	A.05.00

PCS 1900

Selects PCS 1900 as the band for the current step.

Key Path	Source, List Sequencer, List Sequencer Setup, Radio Setup, Radio Standard, GSM/EDGE
Initial S/W Revision	A.05.00

GSM 450

Selects GSM 450 as the band for the current step.

Key Path	Source, List Sequencer, List Sequencer Setup, Radio Setup, Radio Standard, GSM/EDGE
Initial S/W Revision	A.05.00

GSM 480

Selects GSM 480 as the band for the current step.

Key Path	Source, List Sequencer, List Sequencer Setup, Radio Setup, Radio Standard, GSM/EDGE
Initial S/W Revision	A.05.00

GSM 850

Selects GSM 850 as the band for the current step.

Key Path	Source, List Sequencer, List Sequencer Setup, Radio Setup, Radio Standard, GSM/EDGE
Initial S/W Revision	A.05.00

GSM 700

Selects GSM 700 as the band for the current step.

Key Path	Source, List Sequencer, List Sequencer Setup, Radio Setup, Radio Standard, GSM/EDGE
Initial S/W Revision	A.05.00

T-GSM 810

Selects T-GSM 810 as the band for the current step.

Key Path	Source, List Sequencer, List Sequencer Setup, Radio Setup, Radio Standard, GSM/EDGE
Initial S/W Revision	A.05.00

WCDMA

Pressing this key once selects WCDMA as the radio standard and the current WCDMA band as the active channel band. Pressing this key again allows access to the sub-menus for selecting a different WCDMA band.

Key Path	Source, List Sequencer, List Sequencer Setup, Radio Setup, Radio Standard
Initial S/W Revision	A.05.00

Band I

Selects Band I as the band for the current step.

Key Path	Source, List Sequencer, List Sequencer Setup, Radio Setup, Radio Standard, WCDMA
Initial S/W Revision	A.05.00

Band II

Selects Band II as the band for the current step.

Key Path	Source, List Sequencer, List Sequencer Setup, Radio Setup, Radio Standard, WCDMA
Initial S/W Revision	A.05.00

Band III

Selects Band III as the band for the current step.

Key Path	Source, List Sequencer, List Sequencer Setup, Radio Setup, Radio Standard, WCDMA
Initial S/W Revision	A.05.00

Band IV

Selects Band IV as the band for the current step.

Key Path	Source, List Sequencer, List Sequencer Setup, Radio Setup, Radio Standard, WCDMA
Initial S/W Revision	A.05.00

Band V

Selects Band V as the band for the current step.

Key Path	Source, List Sequencer, List Sequencer Setup, Radio Setup, Radio Standard, WCDMA
Initial S/W Revision	A.05.00

Band VI

Selects Band VI as the band for the current step.

Key Path	Source, List Sequencer, List Sequencer Setup, Radio Setup, Radio Standard, WCDMA
Initial S/W Revision	A.05.00

Band VII

Selects Band VII as the band for the current step.

Key Path	Source, List Sequencer, List Sequencer Setup, Radio Setup, Radio Standard, WCDMA
Initial S/W Revision	A.05.00

Band VIII

Selects Band VIII as the band for the current step.

Key Path	Source, List Sequencer, List Sequencer Setup, Radio Setup, Radio Standard, WCDMA
Initial S/W Revision	A.05.00

Band IX

Selects Band IX as the band for the current step.

Key Path	Source, List Sequencer, List Sequencer Setup, Radio Setup, Radio Standard, WCDMA
Initial S/W Revision	A.05.00

Band X

Selects Band X as the band for the current step.

Key Path	Source, List Sequencer, List Sequencer Setup, Radio Setup, Radio Standard, WCDMA
Initial S/W Revision	A.05.00

Band XI

Selects Band XI as the band for the current step.

Key Path	Source, List Sequencer, List Sequencer Setup, Radio Setup, Radio Standard, WCDMA
Initial S/W Revision	A.05.00

Band XII

Selects Band XII as the band for the current step.

Key Path	Source, List Sequencer, List Sequencer Setup, Radio Setup, Radio Standard, WCDMA
Initial S/W Revision	A.05.00

Band XIII

Selects Band XIII as the band for the current step.

Key Path	Source, List Sequencer, List Sequencer Setup, Radio Setup, Radio Standard, WCDMA
Initial S/W Revision	A.05.00

Band XIV

Selects Band XIV as the band for the current step.

Key Path	Source, List Sequencer, List Sequencer Setup, Radio Setup, Radio Standard, WCDMA
Initial S/W Revision	A.05.00

LTE

Pressing this key once selects LTE FDD as the radio standard and the current LTE FDD band as the active channel band. Pressing this key again allows access to the sub-menus for selecting a different LTE FDD band.

Key Path	Source, List Sequencer, List Sequencer Setup, Radio Setup, Radio Standard
Initial S/W Revision	A.09.50

BAND 1

Selects BAND 1 as the band for the current step.

Key Path	Source, List Sequencer, List Sequencer Setup, Radio Setup, Radio Standard, LTE
Initial S/W Revision	A.09.50

BAND 2

Selects BAND 2 as the band for the current step.

Key Path	Source, List Sequencer, List Sequencer Setup, Radio Setup, Radio Standard, LTE
Initial S/W Revision	A.09.50

BAND 3

Selects BAND 3 as the band for the current step.

Key Path	Source, List Sequencer, List Sequencer Setup, Radio Setup, Radio Standard, LTE
Initial S/W Revision	A.09.50

BAND 4

Selects BAND 4 as the band for the current step.

Key Path	Source, List Sequencer, List Sequencer Setup, Radio Setup, Radio Standard, LTE
Initial S/W Revision	A.09.50

BAND 5

Selects BAND 5 as the band for the current step.

Key Path	Source, List Sequencer, List Sequencer Setup, Radio Setup, Radio Standard, LTE
Initial S/W Revision	A.09.50

BAND 6

Selects BAND 6 as the band for the current step.

Key Path	Source, List Sequencer, List Sequencer Setup, Radio Setup, Radio Standard, LTE
Initial S/W Revision	A.09.50

BAND 7

Selects BAND 7 as the band for the current step.

Key Path	Source, List Sequencer, List Sequencer Setup, Radio Setup, Radio Standard, LTE
Initial S/W Revision	A.09.50

BAND 8

Selects BAND 8 as the band for the current step.

Key Path	Source, List Sequencer, List Sequencer Setup, Radio Setup, Radio Standard, LTE
Initial S/W Revision	A.09.50

BAND 9

Selects BAND 9 as the band for the current step.

Key Path	Source, List Sequencer, List Sequencer Setup, Radio Setup, Radio Standard, LTE
Initial S/W Revision	A.09.50

BAND 10

Selects BAND 10 as the band for the current step.

Key Path	Source, List Sequencer, List Sequencer Setup, Radio Setup, Radio Standard, LTE
Initial S/W Revision	A.09.50

BAND 11

Selects BAND 11 as the band for the current step.

Key Path	Source, List Sequencer, List Sequencer Setup, Radio Setup, Radio Standard, LTE
Initial S/W Revision	A.09.50

BAND 12

Selects BAND 12 as the band for the current step.

Key Path	Source, List Sequencer, List Sequencer Setup, Radio Setup, Radio Standard, LTE
Initial S/W Revision	A.09.50

BAND 13

Selects BAND 13 as the band for the current step.

Key Path	Source, List Sequencer, List Sequencer Setup, Radio Setup, Radio Standard, LTE
Initial S/W Revision	A.09.50

BAND 14

Selects BAND 14 as the band for the current step.

Key Path	Source, List Sequencer, List Sequencer Setup, Radio Setup, Radio Standard, LTE
Initial S/W Revision	A.09.50

BAND 17

Selects BAND 17 as the band for the current step.

Key Path	Source, List Sequencer, List Sequencer Setup, Radio Setup, Radio Standard, LTE
Initial S/W Revision	A.09.50

BAND 18

Selects BAND 18 as the band for the current step.

Key Path	Source, List Sequencer, List Sequencer Setup, Radio Setup, Radio Standard, LTE
Initial S/W Revision	A.09.50

BAND 19

Selects BAND 19 as the band for the current step.

Key Path	Source, List Sequencer, List Sequencer Setup, Radio Setup, Radio Standard, LTE
Initial S/W Revision	A.09.50

BAND 20

Selects BAND 20 as the band for the current step.

Key Path	Source, List Sequencer, List Sequencer Setup, Radio Setup, Radio Standard, LTE
Initial S/W Revision	A.09.50

BAND 21

Selects BAND 21 as the band for the current step.

Key Path	Source, List Sequencer, List Sequencer Setup, Radio Setup, Radio Standard, LTE
Initial S/W Revision	A.09.50

BAND 24

Selects BAND 24 as the band for the current step.

Key Path	Source, List Sequencer, List Sequencer Setup, Radio Setup, Radio Standard, LTE
Initial S/W Revision	A.09.50

BAND 25

Selects BAND 25 as the band for the current step.

Key Path	Source, List Sequencer, List Sequencer Setup, Radio Setup, Radio Standard, LTE
Initial S/W Revision	A.09.50

BAND 26

Selects BAND 26 as the band for the current step.

Key Path	Source, List Sequencer, List Sequencer Setup, Radio Setup, Radio Standard, LTE
Initial S/W Revision	A.12.53

BAND 27

Selects BAND 27 as the band for the current step.

Key Path	Source, List Sequencer, List Sequencer Setup, Radio Setup, Radio Standard, LTE
Initial S/W Revision	A.14.00

BAND 28

Selects BAND 28 as the band for the current step.

Key Path	Source, List Sequencer, List Sequencer Setup, Radio Setup, Radio Standard, LTE
Initial S/W Revision	A.14.00

BAND 31

Selects BAND 31 as the band for the current step.

Key Path	Source, List Sequencer, List Sequencer Setup, Radio Setup, Radio Standard, LTE
Initial S/W Revision	A.14.00

LTE TDD

Sets LTE TDD as the radio standard for use and accesses the LTE TDD specific channel band sub-menus..

Key Path	Source, Frequency, Radio Setup, Radio Standard
Initial S/W Revision	A.11.50

BAND 33

Selects BAND 33 as the band for the current step.

Key Path	Source, Frequency, Radio Setup, Radio Standard, LTE TDD
Example	:SOUR:FREQ:CHAN:BAND BAND33
Initial S/W Revision	A.11.50

BAND 34

Selects BAND 34 as the band for the current step.

Key Path	Source, Frequency, Radio Setup, Radio Standard, LTE TDD
Example	:SOUR:FREQ:CHAN:BAND BAND34
Initial S/W Revision	A.11.50

BAND 35

Selects BAND 35 as the band for the current step.

Key Path	Source, Frequency, Radio Setup, Radio Standard, LTE TDD
Example	:SOUR:FREQ:CHAN:BAND BAND35
Initial S/W Revision	A.11.50

BAND 36

Selects BAND 36 as the band for the current step.

Key Path	Source, Frequency, Radio Setup, Radio Standard, LTE TDD
Example	:SOUR:FREQ:CHAN:BAND BAND36
Initial S/W Revision	A.11.50

BAND 37

Selects BAND 37 as the band for the current step.

Key Path	Source, Frequency, Radio Setup, Radio Standard, LTE TDD
Example	:SOUR:FREQ:CHAN:BAND BAND37
Initial S/W Revision	A.11.50

BAND 38

Selects BAND 38 as the band for the current step.

Key Path	Source, Frequency, Radio Setup, Radio Standard, LTE TDD
Example	:SOUR:FREQ:CHAN:BAND BAND38
Initial S/W Revision	A.11.50

BAND 39

Selects BAND 39 as the band for the current step.

Key Path	Source, Frequency, Radio Setup, Radio Standard, LTE TDD
Example	:SOUR:FREQ:CHAN:BAND BAND39
Initial S/W Revision	A.11.50

BAND 40

Selects BAND 40 as the band for the current step.

Key Path	Source, Frequency, Radio Setup, Radio Standard, LTE TDD
Example	:SOUR:FREQ:CHAN:BAND BAND40
Initial S/W Revision	A.11.50

BAND 41

Selects BAND 41 as the band for the current step.

Key Path	Source, Frequency, Radio Setup, Radio Standard, LTE TDD
Example	:SOUR:FREQ:CHAN:BAND BAND41
Initial S/W Revision	A.11.50

BAND 42

Selects BAND 42 as the band for the current step.

Key Path	Source, Frequency, Radio Setup, Radio Standard, LTE TDD
Example	:SOUR:FREQ:CHAN:BAND BAND42
Initial S/W Revision	A.11.50

BAND 43

Selects BAND 43 as the band for the current step.

Key Path	Source, Frequency, Radio Setup, Radio Standard, LTE TDD
Example	:SOUR:FREQ:CHAN:BAND BAND43
Initial S/W Revision	A.11.50

BAND 44

Selects BAND 44 as the band for the current step.

Key Path	Source, List Sequencer, List Sequencer Setup, Radio Setup, Radio Standard, LTE TDD
Initial S/W Revision	A.14.00

TDSCDMA

Sets TDSCDMA as the radio standard for use and accesses the TDSCDMA specific channel band sub-menus..

Key Path	Source, Frequency, Radio Setup, Radio Standard
Initial S/W Revision	A.11.50

BAND A

Selects BAND A as the band for the current step.

Key Path	Source, Frequency, Radio Setup, Radio Standard, TDSCDMA
Example	:SOUR:FREQ:CHAN:BAND BANDA
Initial S/W Revision	A.11.50

BAND B

Selects BAND B as the band for the current step.

Key Path	Source, Frequency, Radio Setup, Radio Standard, TDSCDMA
Example	:SOUR:FREQ:CHAN:BAND BANDB
Initial S/W Revision	A.11.50

BAND C

Selects BAND C as the band for the current step.

Key Path	Source, Frequency, Radio Setup, Radio Standard, TDSCDMA
Example	:SOUR:FREQ:CHAN:BAND BANDC
Initial S/W Revision	A.11.50

BAND D

Selects BAND D as the band for the current step.

Key Path	Source, Frequency, Radio Setup, Radio Standard, TDSCDMA
Example	:SOUR:FREQ:CHAN:BAND BANDD
Initial S/W Revision	A.11.50

BAND E

Selects BAND E as the band for the current step.

Key Path	Source, Frequency, Radio Setup, Radio Standard, TDSCDMA
Example	:SOUR:FREQ:CHAN:BAND BANDE
Initial S/W Revision	A.11.50

BAND F

Selects BAND F as the band for the current step.

Key Path	Source, Frequency, Radio Setup, Radio Standard, TDSCDMA
Example	:SOUR:FREQ:CHAN:BAND BANDF
Initial S/W Revision	A.11.50

Radio Band Link

Allows you to specify the radio band link direction for the steps within the list sequence. The link is used in conjunction with the channel band and channel number to determine the output frequency.

When set to “Uplink”, the source will calculate the uplink frequency according to an uplink formula together with selected channel band and channel number. When set to “Downlink”, the source will calculate the downlink frequency according to a downlink formula together with selected channel band and channel number.

Key Path	Source, List Sequencer, List Sequencer Setup, Radio Setup
Remote Command	:SOURce:LIST:STEP[1] 2 3...1000:SETup:RADio:BAND:LINK DOWN UP :SOURce:LIST:STEP[1] 2 3...1000:SETup:RADio:BAND:LINK?
Example	:SOUR:LIST:STEP2:SET:RAD:BAND:LINK UP :SOUR:LIST:STEP2:SET:RAD:BAND:LINK?
Notes	SCPI is supported after A.09.40
Preset	DOWN
Range	DOWN UP
Initial S/W Revision	A.05.00

Channel

Allows you to specify the frequency of the current step via a channel number.

Key Path	Source, List Sequencer, List Sequencer Setup
Remote Command	:SOURce:LIST:STEP[1] 2 3...1000:SETup:CNFRrequency <double> :SOURce:LIST:STEP[1] 2 3...1000:SETup:CNFRrequency?
Example	:SOUR:LIST:STEP2:SET:CNFR 124 :SOUR:LIST:STEP2:SET:CNFR?
Notes	SCPI is supported after A.09.40. This SCPI is used to setup channel number or frequency setting, according to current Radio Band setting. If Radio Band is "NONE", then it's frequency. If Radio Band is not "NONE", then it's channel number.
Couplings	The channel number is coupled to the step frequency value. When the step frequency value is changed, the channel number will increase or decrease to match the new step frequency. If the step frequency is not at an exact match for a channel number, the nearest channel number is displayed, along with a greater than, or less than sign to indicate the frequency is above or below the channel number.
Preset	1
Min	0 (Please refer to for valid ranges.)
Max	10838 (Please refer to for valid ranges.)
Initial S/W Revision	A.05.00

Frequency

Allows you to specify a frequency value for the current step.

Key Path	Source, List Sequencer, List Sequencer Setup
Remote Command	:SOURce:LIST:STEP[1] 2 3...1000:SETup:CNFRrequency <double> :SOURce:LIST:STEP[1] 2 3...1000:SETup:CNFRrequency?
Example	:SOUR:LIST:STEP2:SET:CNFR 1GHz :SOUR:LIST:STEP2:SET:CNFR?
Notes	SCPI is supported after A.09.40. This SCPI is used to setup channel number or frequency setting, according to current Radio Band setting. If Radio Band is "NONE", then it's frequency. If Radio Band is not "NONE", then it's channel number.
Couplings	The frequency value is coupled to the channel band and number for the step, such that updates to the radio band and channel number will update the frequency value to the corresponding absolute frequency. The reverse is also true, changing the frequency value causes the value of the channel number to be updated.
Preset	1.00 GHz
Min	10.00 MHz
Max	Hardware Dependant:

	Option 503 = 3.6 GHz Option 504 = 3.9 GHz Option 506 = 6.00 GHz
Initial S/W Revision	A.05.00

Power

Allows you to specify a power value for the current step.

Key Path	Source, List Sequencer, List Sequencer Setup
Remote Command	:SOURce:LIST:STEP[1] 2 3...1000:SETup:AMPLitude <double> :SOURce:LIST:STEP[1] 2 3...1000:SETup:AMPLitude?
Example	:SOUR:LIST:STEP2:SET:AMPL -50dBm :SOUR:LIST:STEP2:SET:AMPL?
Notes	SCPI is supported after A.09.40
Notes	Amplitude corrections can be specified for use with the source. In the event of amplitude corrections being applied, the valid ranges for the RF power do not change dependant on the current amplitude correction setting. Instead, if the combination of RF power + amplitude correction is higher or lower than the source output range, the Source Unleveled bit is set and the "Source Unleveled" indicator will appear on status panel to indicate that the source cannot maintain the output power that has been requested. The multiport adapter RFIO TX ports and GPS ports cannot ensure power accuracy when power setting is lower than -130dBm, this power setting value is defined by the sum of RF Power setting and related amplitude correction value. But user settable value could be lower than this limit. When application detected there exists power setting lower than -130dBm on MPA RFIO TX ports, then popup warning message . When application detected there exists power setting lower than -130dBm on MPA GPS ports, then popup warning message . These are only warning messages, and check is performed when RF is ON.
Notes	The Min and Max value here defined UI settable amplitude range. This range is larger than actual amplitude range with level accuracy defined in spec.
Dependencies	The RF power is dependent on the RF output port and frequency, such that the current frequency and selected output port determine the valid range of power values.
Preset	-100 dBm
Min	The range of values depends on the current frequency and selected RF output port. Please refer to "RF Power" on page 2098 and the table RF Power Range for the valid ranges.
Max	The range of values depends on the current frequency and selected RF output port. Please refer to "RF Power" on page 2098 and the table RF Power Range for the valid ranges.
Initial S/W Revision	A.05.00

Waveform

Allows you access to the sub-menus for selecting the waveform to be played back during the current step. Pressing this key also changes the central display area to show the Waveform File Selection view.

Key Path	Source, List Sequencer, List Sequencer Setup
Remote Command	:SOURce:LIST:STEP[1] 2 3...1000:SETup:WAVeform <string> :SOURce:LIST:STEP[1] 2 3...1000:SETup:WAVeform?
Example	:SOUR:LIST:STEP2:SET:WAV "CW" :SOUR:LIST:STEP2:SET:WAV?
Notes	SCPI is supported after A.09.40
Remote Command Notes	String type, takes "Off" "CW" "Cont" "waveform name"
Preset	CW
Range	Waveform Continue Previous CW Off
Initial S/W Revision	A.05.00

CW

Sets the current step to output a CW tone.

Key Path	Source, List Sequencer, List Sequencer Setup, Waveform
Example	:SOUR:LIST:STEP2:SET:WAV "CW"
Notes	SCPI is supported after A.09.40
Initial S/W Revision	A.05.00

Selected Waveform

Inserts the currently selected waveform in the waveform selection view as the waveform for playback during the current step.

Key Path	Source, List Sequencer, List Sequencer Setup, Waveform
Example	:SOUR:LIST:STEP2:SET:WAV "waveform name"
Notes	SCPI is supported after A.09.40 If the selected waveform contains header (which contains ARB play parameters), source list sequence will automatically apply header settings of the selected waveform in that step.
Initial S/W Revision	A.05.00

Continue Previous

Sets the current step to continue with playback of the waveform from the previous step. When continuing the previous waveform, the ARB playback will not pause while the source retunes to the new frequency or amplitude that may be defined for the new step.

Key Path	Source, List Sequencer, List Sequencer Setup, Waveform
----------	--

Example	:SOUR:LIST:STEP2:SET:WAV "Cont"
Notes	SCPI is supported after A.09.40
Initial S/W Revision	A.05.00

Off

Disable RF output of the current step.

Key Path	Source, List Sequencer, List Sequencer Setup, Waveform
Example	:SOUR:LIST:STEP2:SET:WAV "Off"
Notes	SCPI is supported after A.09.40
Initial S/W Revision	A.05.00

Segments on Hard Disk

Allows you access to the sub-menus for loading waveform segments from the hard disk into ARB memory. The default directory is: D: varb.

Pressing this key changes the current view to the Waveform Management View.

Key Path	Source, Modulation Setup, ARB, Select Waveform
Initial S/W Revision	A.05.00

Load Segment To ARB Memory

Allows you to load the selected file into ARB memory. On the front panel you select the file for loading to the ARB memory by highlighting the desired file in the list. Using the SCPI command, you specify the file name on the HDD.

"NVWFM" (none-volatile storage) MSUS (Mass Storage Unit Specifier) is supported in the memory subsystem because the ARB memory cannot be accessed directly. Therefore, files must be downloaded to the instrument hard disk and then loaded into the ARB memory. "NVWFM" MSUS will be mapped to the default directory D: VARB. The SCPI command supports using either "NVWFM" MSUS or specifying a full path. For more information, see Memory Subsystem (Remote Command Only).

If a file of the same name already exists within ARB memory, it is overwritten. If you wish to load two segments of the same name, you must rename one of the segments before loading it into ARB memory. To rename a segment, you can either use Windows File Explorer, or the :MMEMORY:COPY command.

NOTE: When a waveform file is loaded to ARB memory, burst timing adjustments are made automatically, based on whether or not a Multiport Adapter is connected to the test set and powered on. If the connection/power status of the Multiport Adapter is changed after a waveform file has been loaded, it needs to be loaded again.

Key Path	Source, Modulation Setup, ARB, Select Waveform, Segments on Hard Disk
Remote Command	:SOURce:RADio:ARB:LOAD <string>
Example	:SOUR:RAD:ARB:LOAD "D: VARB\testwaveform.bin" or :SOUR:RAD:ARB:LOAD "NVWFM:testwaveform.bin"
Notes	<p>Because loading the file involves a delay of unpredictable length, this command should be followed by the query *OPC?, which holds off subsequent commands until the loading operating is complete.</p> <p><string> – specifies the path name of the file to load from the HDD into ARB memory. It could be a <full path + filename>, or <"NVWFM" MSUS + colon + filename>.</p> <p>When in Sequence Analyzer mode, and Include Source is Yes, an attempt to load a file to ARB memory will be rejected with an error.</p> <p>When Include Source is No and if there is insufficient free ARB memory to load the selected waveform, an error is generated. .</p> <p>If you specify a file over SCPI, but the file is not at the specified location, an error is generated.</p> <p>If you try to load a waveform file but the file contains less than 500 IQ samples, an error is generated.</p> <p>If you try to load a Signal Studio waveform "*.wfm" which contains invalid waveform header, an error is generated.</p> <p>If the ARB is ON when you load a file to ARB memory or delete a file from ARB memory, the playing waveform segment may not keep phase continuity during the ARB memory operation. The waveform will be replayed after the ARB operation is finished.</p> <p>ARB can be loaded into ARB memory even required licenses do not present on the instrument. In this case, a GUI only warning message -800, "Operation complete; Loaded <filename> successfully, but no license <required licenses> installed". User can install required licenses according to <required licenses> string to license it, or multi-pack license it.</p>
Initial S/W Revision	A.05.00

Load All To ARB Memory

Allows you to load all the segment files within the currently selected directory into ARB memory. If a file of the same name already exists within ARB memory, it is overwritten. If you wish to load two segments of the same name, you must rename one of the segments before loading it into ARB memory. To rename a segment, you can either use Windows File Explorer, or the :MEMory:COPY command.

NOTE: When a waveform file is loaded to ARB memory, burst timing adjustments are made automatically, based on whether or not a Multiport Adapter is connected to the test set and powered on. If the connection/power status of the Multiport Adapter is changed after a waveform file has been loaded, it needs to be loaded again.

Key Path	Source, Modulation Setup, ARB, Select Waveform, Segments on Hard Disk
Remote Command	:SOURce:RADio:ARB:LOAD:ALL <string>
Example	:SOUR:RAD:ARB:LOAD:ALL "D: varb"
Notes	<p><string> - specifies the directory on the HDD to load the files into ARB memory from.</p> <p>When in Sequence Analyzer mode, and Include Source is Yes, an attempt to load all files from a directory to ARB memory is rejected with an error.</p>

	<p>When Include Source is No and there is insufficient free ARB memory to load all the waveforms, when the ARB memory is full, the copy ceases, and an error is generated.</p> <p>If you specify a directory over SCPI, but the directory does not exist, an error is generated.</p> <p>If the ARB is ON, a user then loads or deletes file to ARB memory, the playing waveform segment may not keep phase continuity during the ARB memory operation. The waveform will be replayed after the ARB operation is finished.</p>
Initial S/W Revision	A.05.00

Change Directory...

Allows you to change the currently selected directory on the hard disk. Pressing this key opens a standard windows change directory dialog allowing you to select the new directory of interest.

The current directory is used for manually loading waveform segments into ARB memory for playback, and as a search location for waveform segments that are required to be loaded into ARB memory for playback of a waveform sequence or a list sequence.

Key Path	Source, Modulation Setup, ARB, Select Waveform, Segments on Hard Disk
Notes	No remote command, SCPI front panel only.
Initial S/W Revision	A.05.00

Default Directory...

Allows you to change the default directory. It is used as a search location for waveform segments that are required to be loaded into ARB memory for playback of a waveform sequence, and as a search location for selecting waveforms using SCPI.

Key Path	Source, Modulation Setup, ARB, Select Waveform, Segments on Hard Disk
Remote Command	:SOURce:RADio:ARB:DEFault:DIRectory <string> :SOURce:RADio:ARB: DEFault:DIRectory?
Example	:SOUR:RAD:ARB:DEF:DIR "D:\ArbFiles" :SOUR:RAD:ARB:DEF:DIR?
State Saved	Persistent, survives a power cycle and a preset but not saved in the instrument state
Initial S/W Revision	A.05.00

Segments in ARB Memory

Allows you access to the sub-menus for managing the files within ARB memory.

Key Path	Source, Modulation Setup, ARB, Select Waveform
Initial S/W Revision	A.05.00

Delete Segment From ARB Mem

Allows you to remove a segment from ARB playback memory.

Key Path	Source, Modulation Setup, ARB, Select Waveform, Segments in ARB Memory
Remote Command	:SOURce:RADio:ARB:DELeTe <string>
Example	:SOUR:RAD:ARB:DEL "testwaveform.bin"
Notes	<p><string> - specifies the waveform to be deleted from the ARB playback memory.</p> <p>When in Sequence Analyzer mode and Include Source is Yes, an attempt to delete a file from ARB memory is rejected with an error.</p> <p>When Include Source is No and you specify a file that does not exist within ARB memory, an error is generated.</p> <p>It is possible to delete files from within the ARB memory when the ARB is ON. However, if you attempt to delete the file that is currently playing an error is generated.</p> <p>It is possible to delete a file from within the ARB memory when the sequencer state is ON and the file is not being used by the List Sequencer. If you attempt to delete a file which is being used by the list sequencer, an error is generated.</p> <p>When sequencer state is On, even if ARB state is On, the selected waveform will not be played. In this case, if the selected waveform is not used in List Sequence, it can be deleted and the ARB state is turned Off.</p> <p>If the ARB is ON and you load a file to ARB memory or delete a file from ARB memory, the playing waveform segment may not keep phase continuity during the ARB memory operation. The waveform will be replayed after the ARB operation is finished.</p>
Initial S/W Revision	A.05.00

Delete All From ARB Memory

Allows you to remove all segments from ARB playback memory.

Key Path	Source, Modulation Setup, ARB, Select Waveform, Segments in ARB Memory
Remote Command	:SOURce:RADio:ARB:DELeTe:ALL
Example	:SOUR:RAD:ARB:DELeTe:ALL
Notes	<p>When in Sequence Analyzer mode and Include Source is Yes, an attempt to delete all files from ARB memory is rejected with an error.</p> <p>When Include Source is No and you attempt to delete all files from ARB memory when the ARB is currently playing a file, all files except the one playing are deleted and an error is generated.</p> <p>If you attempt to delete all files from ARB memory when there are waveform files used in "List Sequencer" on page 2168 and "Sequencer" on page 2168 state is ON, all files except the files currently being used in list sequencer are deleted, and an error is generated.</p> <p>If the ARB is ON and you load a file to ARB memory or delete a file from ARB memory, the playing waveform segment may not keep phase continuity during the ARB memory operation. The waveform will be replayed after the ARB operation is finished.</p>
Initial S/W Revision	A.05.00

Step Duration

Allows access to the sub-menus for setting up the duration of play for the current step.

The duration can be set to be either the number of times for the ARB file associated with the sequence to play, or a specific time value, or continuous. If the step is set to play a CW tone, the step duration cannot be set to a play count.

Key Path	Source, List Sequencer, List Sequencer Setup
Remote Command	:SOURce:LIST:STEP[1] 2 3...1000:SETup:DURation:TYPE TIME COUNT CONTinuous CABort :SOURce:LIST:STEP[1] 2 3...1000:SETup:DURation:TYPE?
Example	:SOUR:LIST:STEP2:SET:DUR:TYPE TIME :SOUR:LIST:STEP2:SET:DUR:TYPE?
Notes	SCPI is supported after A.09.40
Notes	If “Step Duration” is set to “Time” or “Play Count” for the last step, the last step of ARB keeps playing as if set to “Continuous”, until the set “Time” has expired or until the “Play Count” setting is reached. However, you can query Error! Reference source not found. Source Sweeping Condition Message to find out if the current list sequence is complete or not.
Range	Time Play Count Continuous Continuous Abort
Initial S/W Revision	A.05.00

Time

Sets the duration of the current step to be a time value for the length of time the step will play. Pressing this key again opens another menu which allows you to set the time value for the step duration.

Key Path	Source, List Sequencer, List Sequencer Setup, Step Duration
Example	:SOUR:LIST:STEP2:SET:DUR:TYPE TIME
Notes	SCPI is supported after A.09.40
Initial S/W Revision	A.05.00

Duration Time

Allows you to specify the length of time the current step will play.

If the Transition Time value is longer than the Step Duration Time, an error is generated when initiating a source list sequence. For source list sequence, transition time is included in the step duration length (not occupy additional time). If the Transition Time value is longer than the Step Duration Time, the real step duration length is extended to equal the transition time and cause a timing shift. This check is also described in section **Error! Reference source not found.** List Sequence Step Validation.

Key Path	Source, List Sequencer, List Sequencer Setup, Step Duration, Time
Remote Command	:SOURce:LIST:STEP[1] 2 3...1000:SETup:DURation:TCOUNT <double> :SOURce:LIST:STEP[1] 2 3...1000:SETup:DURation:TCOUNT?

Example	:SOUR:LIST:STEP2:SET:DUR:TCO 1s :SOUR:LIST:STEP2:SET:DUR:TCO?
Notes	SCPI is supported after A.09.40 This SCPI is reused by "Play Count", "Duration Time" and "Continuous Abort" according to current Duration Type setting is "Play Count" or "Duration Time" or "Continuous Abort". If current "Duration Type" is "Continuous", then popup error -221, "Settings conflict; Cannot accept time or count input when step duration type is Continuous on step #"
Notes	If "Duration Time" is set for the last step, the last step of ARB keeps playing as if set to "Continuous" after set time expires. However, you can query Source Sweeping Condition Message (:STAT:OPER:COND?) to find out if the current list sequence is complete or not.
Preset	1.00 ms
Min	100 μ s
Max	1800 s
Initial S/W Revision	A.05.00

Play Count

Sets the duration of the current step to be an integer value for the number of times (play count) the ARB file is selected for playback during this step. For example, a 5 second ARB will be set to play 5 times during the step.

Key Path	Source, List Sequencer, List Sequencer Setup, Step Duration
Example	:SOUR:LIST:STEP2:SET:DUR:TYPE COUN
Notes	SCPI is supported after A.09.40 This key is unavailable and is grayed out if the current step is configured to CW tone rather than an ARB waveform.
Initial S/W Revision	A.05.00

Header Utilities

Allows access to the header utilities sub-menu. Pressing this key also causes the central display area to change to display the File Header Information view.

Key Path	Source, Modulation Setup, ARB
Dependencies	This key is only available if there is currently a waveform selected for playback. If no waveform is selected, the key is grayed out.
Initial S/W Revision	A.05.00

Continuous

Sets the current step to be played continuously until the next step starts. The waveform will always play completely before transitioning to the next step.

Key Path	Source, List Sequencer, List Sequencer Setup, Step Duration
Example	:SOUR:LIST:STEP2:SET:DUR:TYPE CONT
Notes	SCPI is supported after A.09.40
Initial S/W Revision	A.05.00

Output Trigger

Allows you to specify the trigger output for the current step. The trigger output signal is sent at the start of the step.

When select “On”, trigger event will occur on both Internal and External2 paths. Select “Off” will turn off trigger output.

Key Path	Source, List Sequencer, List Sequencer Setup
Remote Command	:SOURce:LIST:STEP [1] 2 3...1000:SETup:OUTPut:TRIGger ON OFF 1 0 :SOURce:LIST:STEP [1] 2 3...1000:SETup:OUTPut:TRIGger
Example	:SOUR:LIST:STEP2:SET:OUTP:TRIG ON :SOUR:LIST:STEP2:SET:OUTP:TRIG?
Notes	SCPI is supported after A.09.40
Preset	Off
Range	On Off
Initial S/W Revision	A.05.00

Repetition

Allows access to the sub-menu for selecting the repetition type for the list sequencer globally. It cannot be changed between different sequence steps.

Key Path	Source, List Sequencer
Remote Command	:SOURce:LIST:REPetition:TYPE SINGLE CONTInuous
Example	:SOUR:LIST:REP:TYPE SING :SOUR:LIST:REP:TYPE?
Preset	SINGLE
Range	SINGLE CONTInuous
Initial S/W Revision	A.14.50

Single

Sets the repetition type as single for the whole source sequence. Source list will play one time after initiation.

Key Path	Source, List Sequencer, Repetition
Example	:SOUR:LIST:REP:TYPE SINGLE
Initial S/W Revision	A.14.50

Continuous

Sets the repetition type as continuous for the whole source sequence. Source list will play continuously after initiation.

Key Path	Source, List Sequencer, Repetition
Example	:SOUR:LIST:REP:TYPE CONTInuous
Initial S/W Revision	A.14.50

Trigger Type

Allows access to the sub-menu for selecting the output trigger type for the list sequencer globally. It cannot be changed between different sequence steps.

Key Path	Source, List Sequencer
Remote Command	:SOURce:LIST:TRIGgerout:TYPe BEGInningofstep DATAmarker
Example	:SOUR:LIST:TRIG:TYP BEG :SOUR:LIST:TRIG:TYP?
Notes	SCPI is supported after A.14.00
Preset	BEGInningofstep
Range	BEGInningofstep DATAmarker
Initial S/W Revision	A.14.00

BeginningOfStep

Sets the output trigger type as BeginningOfStep for the whole source sequence.

Key Path	Source, List Sequencer, Trigger Type
Example	:SOUR:LIST:TRIG:TYP BEG
Notes	SCPI is supported after A.14.00
Initial S/W Revision	A.14.00

DataMarker

Sets the output trigger type as DataMarker for the whole source sequence. When DataMarker is selected, which marker to route is also needed to be set.

Key Path	Source, List Sequencer, Trigger Type
Example	:SOUR:LIST:TRIG:TYP DAT
Notes	SCPI is supported after A.14.00
Initial S/W Revision	A.14.00

Marker 1

Sets the output trigger maker routing to Marker 1 for DataMarker in the whole source sequence.

Key Path	Source, List Sequencer, Trigger Type, DataMarker
Example	:SOUR:LIST:TRIG:TYPE:MARK M1
Notes	SCPI is supported after A.14.00
Initial S/W Revision	A.14.00

Marker 2

Sets the output trigger maker routing to Marker 2 for DataMarker in the whole source sequence.

Key Path	Source, List Sequencer, Trigger Type, DataMarker
Example	:SOUR:LIST:TRIG:TYPE:MARK M2
Notes	SCPI is supported after A.14.00
Initial S/W Revision	A.14.00

Marker 3

Sets the output trigger maker routing to Marker 3 for DataMarker in the whole source sequence.

Key Path	Source, List Sequencer, Trigger Type, DataMarker
Example	:SOUR:LIST:TRIG:TYPE:MARK M3
Notes	SCPI is supported after A.14.00
Initial S/W Revision	A.14.00

Marker 4

Sets the output trigger maker routing to Marker 4 for DataMarker in the whole source sequence.

Key Path	Source, List Sequencer, Trigger Type, DataMarker
Example	:SOUR:LIST:TRIG:TYPE:MARK M4
Notes	SCPI is supported after A.14.00
Initial S/W Revision	A.14.00

Manual Trigger Now

Pressing this key provides a software trigger event to the list sequencer. During execution of sequence, if the sequencer is halted on any step that has been configured with a “Manual” step trigger, then this key press will cause the sequencer to continue and execute the step.

Key Path	Source, List Sequencer
Remote Command	No remote command, front panel only.
Initial S/W Revision	A.05.00

Source Preset

Allows you to preset the source settings to their default values.

Key Path	Source
Remote Command	:SOURce:PRESet
Example	:SOUR:PRES

SPAN X Scale

Accesses a menu of functions that enable you set the horizontal scale parameters.

This menu is blank if the selected **window** is:

- I/Q Measured Polar Graph or,
- RMS EVM (Numeric Results).

For details of available **views** in this measurement, see "[View/Display](#)" on page 2211. Within a view, you can change the selected window by pressing the Next Window key.

Key Path	Front-panel key
Initial S/W Revision	Prior to A.02.00

Sweep/Control

Accesses a menu that enables you to pause and restart the measurement.

Key Path	Front Panel Key
Initial S/W Revision	Prior to A.02.00

Pause/Resume

Pauses a measurement after the current data acquisition is complete. When Paused, the label on the key changes to Resume. Pressing Resume un-pauses the measurement. See Pause/Resume for details.

Key Path	Sweep/Control
Initial S/W Revision	Prior to A.02.00

System

See "System" on page 189

Trace/Detector

There is no Trace/Detector functionality supported in the Mod Accuracy measurement. The front-panel key will display a blank menu when pressed.

Key Path	Trace/Detector
Initial S/W Revision	Prior to A.02.00

Trigger

See ["Trigger" on page 248](#)

Free Run

See ["Free Run " on page 255](#)

Video

See ["Video \(IF Envelope\) " on page 1440](#)

Trigger Level

See ["Trigger Level " on page 1440](#)

Trig Slope

See ["Trig Slope " on page 1441](#)

Trig Delay

See ["Trig Delay " on page 258](#)

External 1

See ["External 1 " on page 1454](#)

Trigger Level

See ["Trigger Level " on page 1455](#)

Trig Slope

See ["Trig Slope " on page 1455](#)

Trig Delay

See ["Trig Delay " on page 261](#)

Zero Span Delay Comp

See ["Zero Span Delay Comp On/Off " on page 1443](#)

External 2

See ["External 2 " on page 1456](#)

Trigger Level

See ["Trigger Level " on page 1457](#)

Trig Slope

See ["Trig Slope " on page 1457](#)

Trig Delay

See "Trig Delay " on page 264

Zero Span Delay Comp

See "Zero Span Delay Comp On/Off" on page 1446

RF Burst

See "RF Burst " on page 1458

Absolute Trigger

See "Absolute Trigger Level" on page 1458

Relative Trigger

See "Relative Trigger Level" on page 1448

Trig Slope

See "Trigger Slope " on page 1459

Trig Delay

See "Trig Delay " on page 268

Periodic Timer

See "Periodic Timer (Frame Trigger) " on page 1449

Period

See "Period " on page 1451

Offset

See "Offset " on page 1451

Offset Adjust (Remote Command Only)

See "Offset Adjust (Remote Command Only)" on page 1452

Reset Offset Display

See "Reset Offset Display " on page 1453

Sync Source

See "Sync Source " on page 1453

Off

See "Off " on page 1454

External 1

See "[External 1](#)" on page 1454

Trigger Level

See "[Trigger Level](#)" on page 1455

Trig Slope

See "[Trig Slope](#)" on page 1455

External 2

See "[External 2](#)" on page 1456

Trigger Level

See "[Trigger Level](#)" on page 1457

Trig Slope

See "[Trig Slope](#)" on page 1457

RF Burst

See "[RF Burst](#)" on page 1458

Absolute Trigger

See "[Absolute Trigger Level](#)" on page 1458

Trig Slope

See "[Trigger Slope](#)" on page 1459

Trig Delay

See "[Trig Delay](#)" on page 280

Auto/Holdoff

See "[Auto/Holdoff](#)" on page 1460

Auto Trig

See "[Auto Trig](#)" on page 1461

Trig Holdoff

See "[Trig Holdoff](#)" on page 1461

Internal

See "[Internal](#)" on page 282

User Preset

Accesses a menu that gives you the following three choices:

- User Preset – recalls a state previously saved using the Save User Preset function.
- User Preset All Modes – presets all of the modes in the analyzer
- Save User Preset– saves the current state for the current mode

NOTE

In products that run multiple instances of the X-Series Application, all instances use the same location to save User Preset state. So Save User Preset of one instance will overwrite the Save User Preset of another instance.

Key Path	Front-panel key
Backwards Compatibility Notes	<p>User Preset is actually loading a state, and in legacy analyzers, it was possible to load a state without affecting the trace data, limit lines or correction data. Similarly it was possible to do a User Preset without affecting the trace data, limit lines or correction data.</p> <p>In the X-Series, “state” always includes all of this data; so whenever state is loaded, or User Preset is executed, all of the traces, limit lines and corrections are affected. Although this differs from previous behavior, it is desirable behavior, and should not cause adverse issues for users.</p> <p>On ESA and PSA, User Preset affected the entire instrument’s state. In the X-Series, User Preset only recalls the state for the active mode. There is a User Preset file for each mode. User Preset can never cause a mode switch as it can in legacy analyzers. If you want to recall all modes to their user preset file state, you will need to do a User Preset after mode switching into each mode.</p> <p>User Preset recalls mode state which can now include data like traces; whereas on ESA and PSA, User Preset did not affect data.</p>
Initial S/W Revision	Prior to A.02.00

User Preset

User Preset sets the state of the currently active mode back to the state that was previously saved for this mode using the Save User Preset menu key or the SCPI command, SYST:PRES:USER:SAV. It not only recalls the Mode Preset settings, but it also recalls all of the mode persistent settings, and the Input/Output system setting that existed at the time Save User Preset was executed.

If a Save User Preset has not been done at any time, User Preset recalls the default user preset file for the currently active mode. The default user preset files are created if, at power-on, a mode detects there is no user preset file. There will never be a scenario when there is no user preset file to restore. For each mode, the default user preset state is the same state that would be saved if a Save User Preset is performed in each mode right after doing a Restore Mode Default and after a Restore Input/Output Defaults.

The User Preset function does the following:

- Aborts the currently running measurement.
- Sets the mode State to the values defined by Save User Preset.
- Makes the saved measurement for the currently running mode the active measurement.
- Brings up the saved menu for the power-on mode.

- Clears the input and output buffers.
- Sets the Status Byte to 0.

Key Path	User Preset
Remote Command	:SYSTem:PRESet:USER
Example	:SYST:PRES:USER:SAVE:SYST:PRES:USER
Notes	:SYST:PRES:USER:SAVE is used to save the current state as the user preset state. Clears all pending OPC bits. The Status Byte is set to 0. Pressing the User Preset front-panel key while already in the User Preset menu will cause the User Preset to get executed
Couplings	A user preset will cause the currently running measurement to be aborted and cause the saved measurement to be active. Recalling a User Preset file has the same issues that recalling a Save State file has. Some settings may need to be limited and therefore re-coupled, since the capabilities of the mode may have changes when the User Preset file was last saved.
Initial S/W Revision	Prior to A.02.00

User Preset All Modes

Recalls all of the User Preset files for each mode, switches to the power-on mode, and activates the saved measurement from the power-on mode User Preset file.

NOTE

When the instrument is secured, all of the user preset files are converted back to their default user preset files.

The User Preset function does the following:

- Aborts the currently running measurement.
- Switches the Mode to the power-on mode.
- Restores the User Preset files for each mode.
- Makes the saved measurement for the power-on mode the active measurement.
- Brings up the saved menu for the power-on mode.
- Clears the input and output buffers.
- Sets the Status Byte to 0.

Key Path	User Preset
Remote Command	:SYSTem:PRESet:USER:ALL
Example	:SYST:PRES:USER:SAVE:SYST:PRES:USER:ALL
Notes	Clears all pending OPC bits. The Status Byte is set to 0. :SYST:PRES:USER:SAVE is used to save the current state as the user preset state.
Couplings	A user preset will cause the currently running measurement to be aborted, cause a mode switch to the power-on mode, and cause the saved measurement to be active in the power-on mode.

Recalling a User Preset file has the same issues that recalling a Save State file has. Some settings may need to be limited and therefore re-coupled, since the capabilities of the mode may have changes when the User Preset file was last saved.

Initial S/W Revision Prior to A.02.00

Save User Preset

Saves the currently active mode and its State. You can recall this User Preset file by pressing the User Preset menu key or sending the SYST:PRES:USER remote command. This same state is also saved by the Save State function.

Key Path	User Preset
Remote Command	:SYSTem:PRESet:USER:SAVE
Example	:SYST:PRES:USER:SAVE
Notes	:SYST:PRES:SAVE creates the same file as if the user requested a *SAV or a MMEM: STOR:STAT, except User Preset Save does not allow the user to specify the filename or the location of the file.
Initial S/W Revision	Prior to A.02.00

View/Display

The Mod Accuracy measurement consists of three views, which are common for both Reverse Link (MS) and Forward Link (BTS) measurements.

NO.	View	Multiple/Single PCG Note 1	NO. of Windows	Window No.	Window
1	VIEW[1] I/Q Measured Polar Graph	Single PCG	Dual (Horizontal)	WINDow[1]	I/Q Measured Polar Vector
				WINDow2	Metrics
2	VIEW2 I/Q Error	Single PCG	Tri (Vertical)	WINDow[1]	EVM
				WINDow2	Magnitude Error
				WINDow3	Phase Error
3	VIEW3 Power, Timing and Phase	Single PCG	One	WINDow[1]	Metrics

Note 1: Single PCG (Power Control Group) means the range to display the trace on view is 1 PCG. When average is on, the measured results are averaged PCG by PCG.

This topic contains the following sections:

["View Selection by name \(SCPI only\)" on page 1962](#)

["View Selection by number \(SCPI only\)" on page 1963](#)

View Selection by name (SCPI only)

Allows you to select the desired measurement view from the following selections:

POLar(1): I/Q Measured Polar Graph - Provides a combination view of an I/Q measured polar vector graph and the summary data as shown below.

ERRor(2): I/Q Error (Tri View) - Provides a combination view of the EVM, magnitude error, and phase error graphs.

TPHase(3): Power, Timing, and Phase-Provides the power of the code channels, and time/phase of the code channels to pilot channel, and also CDE of each code channel.

XXX...X(n) in the above,

XXX...X: Enum ID for :DISP:RHO:VIEW:SEL

n : Numeric ID for :DISP:RHO:VIEW:NSEL

Mode	CDMA2K
Remote Command	:DISPlay:RHO:VIEW[:SElect] POLar ERRor TPHase

	:DISPlay:RHO:VIEW[:SElect]?
Example	DISP:RHO:VIEW:SEL POL DISP:RHO:VIEW:SEL?
Couplings	TPHase(3) is available only if Multi Channel Estimator is On.
Preset	POLar
State Saved	Saved in instrument state.
Range	Polar Graph I/Q Error Power, Timing and Phase
Initial S/W Revision	Prior to A.02.00

View Selection by number (SCPI only)

Displays the numeric values of the measurement results.

Mode	CDMA2K
Remote Command	:DISPlay:RHO:VIEW:NSElect <integer> :DISPlay:RHO:VIEW:NSElect?
Example	DISP:RHO:VIEW:NSEL 1 DISP:RHO:VIEW:NSEL?
Remote Command Notes	You must be in cdma2000 mode to use this command. Use INSTRument:SElect to set the mode.
Preset	1
State Saved	Saved in instrument state.
Min	1
Max	3
Initial S/W Revision	Prior to A.02.00

Key Path	Front panel key
Initial S/W Revision	Prior to A.02.00

Display

Accesses a menu of functions that enable you to set the display parameters.

See "[Display](#)" on page 2212 for more information.

Key Path	View/Display
Initial S/W Revision	Prior to A.02.00

Annotation

Turns on and off various parts of the display annotation. The annotation is divided up into four categories:

1. Meas Bar: This is the measurement bar at the top of the screen. It does not include the settings panel or the Active Function. Turning off the Meas Bar turns off the settings panel and the Active Function. When the Meas Bar is off, the graticule area expands to fill the area formerly occupied by the Meas Bar.
2. Screen Annotation: this is the annotation and annunciation around the graticule, including any annotation on lines (such as the display line, the threshold line, etc.) This does NOT include the marker number or the N dB result. When off, the graticule expands to fill the entire graticule area.
3. Trace annotation: these are the labels on the traces, showing their detector (or their math mode).
4. Active Function annotation: this is the active function display in the meas bar, and all of the active function values displayed on softkeys.

See the figure below. Each type of annotation can be turned on and off individually.

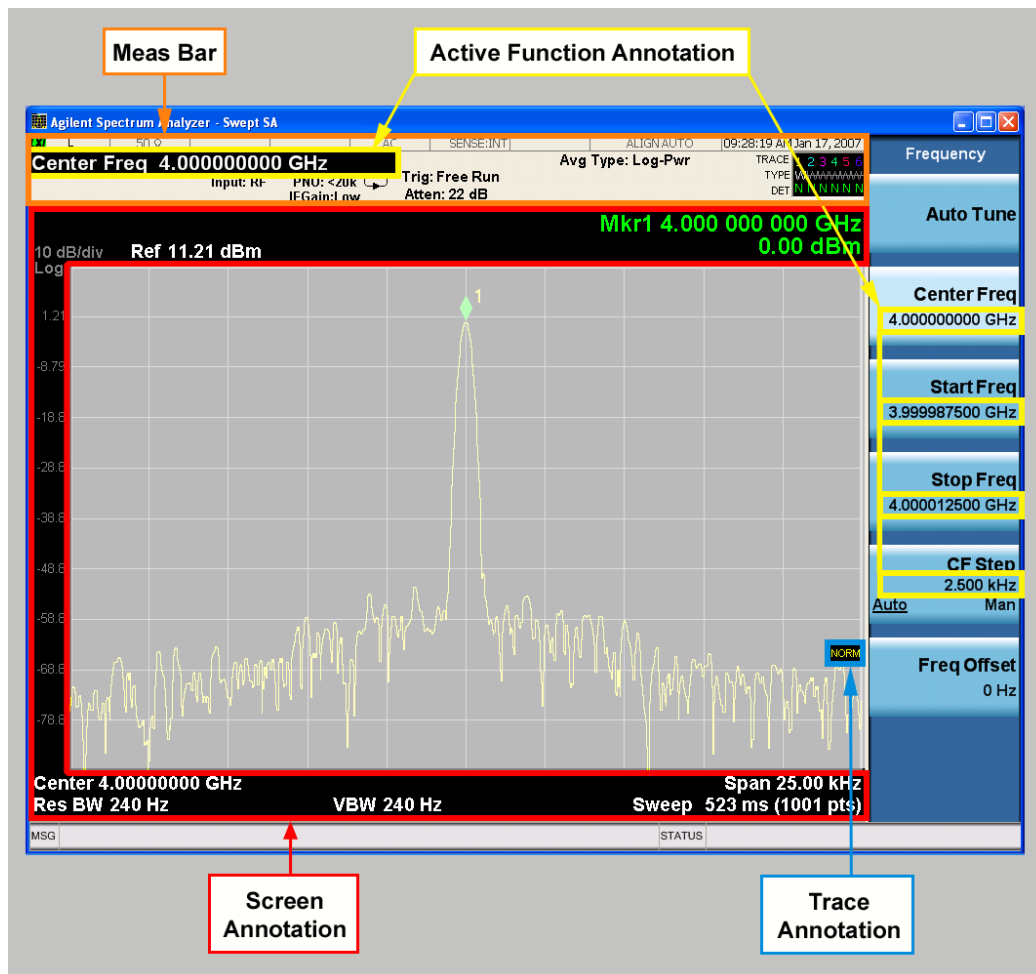

Key Path	View/Display, Display
Initial S/W Revision	Prior to A.02.00

Meas Bar On/Off

This function turns the Measurement Bar on and off, including the settings panel. When off, the graticule area expands to fill the area formerly occupied by the Measurement Bar.

Key Path	View/Display, Display, Annotation
Remote Command	:DISPlay:ANNotation:MBAR[:STATe] OFF ON 0 1 :DISPlay:ANNotation:MBAR[:STATe]?
Example	DISP:ANN:MBAR OFF
Dependencies	Grayed out and forced to OFF when System Display Settings, Annotation is set to Off.
Preset	On This should remain Off through a Preset when System DisplaySettings, Annotation is set to Off.
State Saved	Saved in instrument state.
Initial S/W Revision	Prior to A.02.00

Screen

This controls the display of the annunciation and annotation around the graticule, including any annotation on lines (such as the display line, the threshold line, etc.) and the y-axis annotation. This does NOT include marker annotation (or the N dB result). When off, the graticule expands to fill the entire graticule area, leaving only the 1.5% gap above the graticule as described in the Trace/Detector chapter.

Key Path	View/Display, Display, Annotation
Remote Command	:DISPlay:ANNotation:SCReen[:STATe] OFF ON 0 1 :DISPlay:ANNotation:SCReen[:STATe]?
Example	DISP:ANN:SCR OFF
Dependencies	Grayed-out and forced to OFF when System Display Settings, Annotation is set to Off.
Preset	On This should remain Off through a Preset when System DisplaySettings, Annotation is set to Off
State Saved	Saved in instrument state.
Initial S/W Revision	Prior to A.02.00

Active Function Values On/Off

Turns on and off the active function display in the Meas Bar, and all of the active function values displayed on the softkeys.

Note that all of the softkeys that have active functions have these numeric values blanked when this function is on. This is a security feature..

13 Modulation Accuracy (Composite Rho) Measurement
View/Display

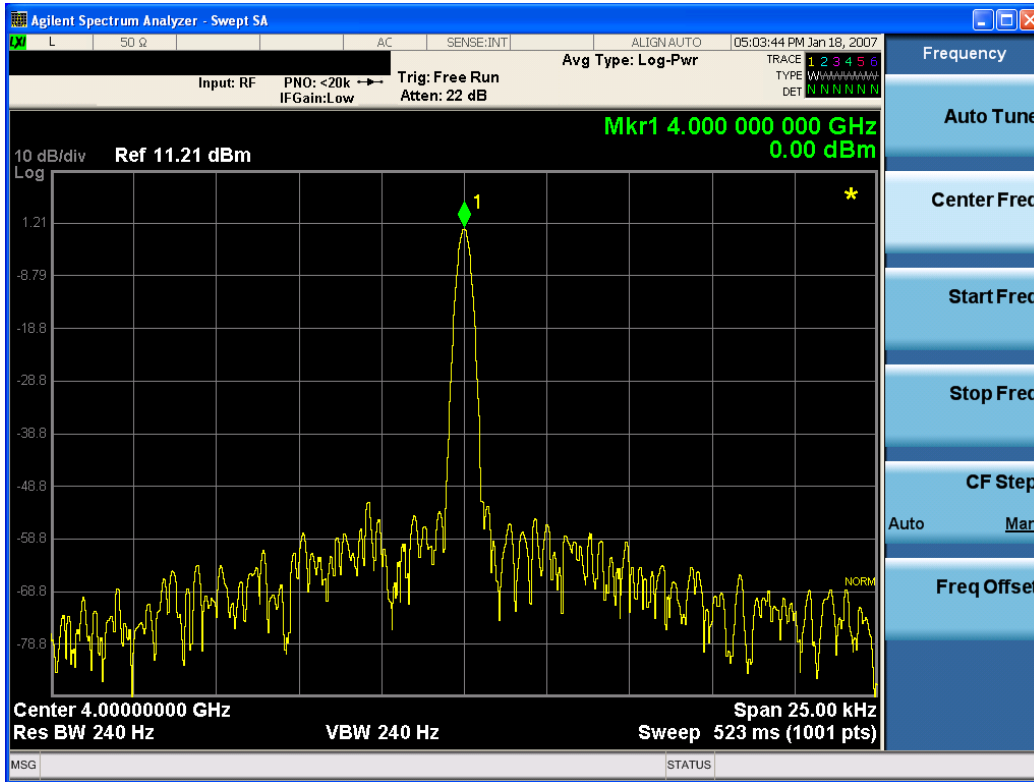

Key Path	View/Display, Display, Annotation
Remote Command	:DISPlay:ACTivefunc[:STATE] ON OFF 1 0 :DISPlay:ACTivefunc[:STATE]?
Example	DISP:ACT OFF
Dependencies	Grayed out and forced to OFF when System Display Settings, Annotation is set to Off.
Preset	On This should remain Off through a Preset when System DisplaySettings, Annotation is set to Off
State Saved	Saved in instrument state.
Initial S/W Revision	Prior to A.02.00

Title

Displays menu keys that enable you to change or clear a title on your display.

Key Path	View/Display, Display
Initial S/W Revision	Prior to A.02.00

Change Title

Writes a title into the "measurement name" field in the banner, for example, "Swept SA".

Press Change Title to enter a new title through the alpha editor. Press Enter or Return to complete the entry. Press ESC to cancel the entry and preserve your existing title.

The display title will replace the measurement name. It remains for this measurement until you press Change Title again, or you recall a state, or a Preset is performed. A title can also be cleared by pressing Title, Clear Title.

NOTE

Notice the inclusion of the <measurement> parameter in the command below. Because each measurement remembers the Display Title, the command must be qualified with the measurement name. For the Swept SA measurement this is not the case; no <measurement> parameter is used when changing the Display Title for the Swept SA measurement.

Key Path	View/Display, Display, Title
Mode	All
Remote Command	:DISPlay:<measurement>:ANNotation:TITLe:DATA <string> :DISPlay:<measurement>:ANNotation:TITLe:DATA?
Example	DISP:ANN:TITL:DATA "This Is My Title" This example is for the Swept SA measurement in the Spectrum Analyzer mode. The SANalyzer <measurement> name is not used. DISP:ACP:ANN:TITL:DATA "This Is My Title" This example is for Measurements other than Swept SA. Both set the title to: This Is My Title
Notes	Pressing this key cancels any active function. When a title is edited the previous title remains intact (it is not cleared) and the cursor goes at the end so that characters can be added or BKSP can be used to go back over previous characters.
Preset	No title (measurement name instead)
State Saved	Saved in instrument state.
Initial S/W Revision	Prior to A.02.00

Clear Title

Clears a title from the front-panel display. Once cleared, the title cannot be retrieved. After the title is cleared, the current Measurement Name replaces it in the title bar.

Key Path	View/Display, Display, Title
Example	The following commands clear the title and restore the measurement's original title: DISP:ANN:TITL:DATA "" This example is for the Swept SA measurement in the Spectrum Analyzer mode. The SANalyzer <measurement> name is not used. DISP:ACP:ANN:TITL:DATA "" This example is for ACP; in measurements other than Swept SA the measurement name is required.
Notes	Uses the :DISPlay:<measurement>:ANNotation:TITLe:DATA <string> command with an empty string (in the Swept SA, the <measurement> is omitted).

Preset	Performed on Preset.
Initial S/W Revision	Prior to A.02.00

Graticule

Pressing Graticule turns the display graticule On or Off. It also turns the graticule y-axis annotation on and off.

Key Path	View/Display, Display
Remote Command	:DISPlay:WINDow[1]:TRACe:GRATicule:GRID[:STATe] OFF ON 0 1 :DISPlay:WINDow[1]:TRACe:GRATicule:GRID[:STATe]?
Example	DISP:WIND:TRAC:GRAT:GRID OFF
Notes	The graticule is the set of horizontal and vertical lines that make up the grid/divisions for the x-axis and y-axis.
Preset	On
State Saved	Saved in instrument state
Initial S/W Revision	Prior to A.02.00

System Display Settings

These settings are "Mode Global" – they affect all modes and measurements and are reset only by Restore Misc Defaults or Restore System Defaults under System.

Key Path	View/Display, Display
Initial S/W Revision	Prior to A.02.00

Annotation Local Settings

This is a Mode Global override of the meas local annotation settings. When it is All Off, it forces ScreenAnnotation, Meas Bar, Trace, and Active Function Values settings to be OFF for all measurements in all modes. This provides the security based "annotation off" function of previous analyzers; hence it uses the legacy SCPI command.

When it is All Off, the Screen, Meas Bar, Trace, and Active Function Values keys under the Display, Annotation menu are grayed out and forced to Off. When Local Settings is selected, you are able to set the local annotation settings on a measurement by measurement basis.

Key Path	View/Display, Display, System Display Settings
Remote Command	:DISPlay:WINDow[1]:ANNotation[:ALL] OFF ON 0 1 :DISPlay:WINDow[1]:ANNotation[:ALL]?
Example	:DISP:WIND:ANN OFF

Preset	On (Set by Restore Misc Defaults)
State Saved	Not saved in instrument state.
Backwards Compatibility Notes	The WINDow parameter and optional subopcode is included for backwards compatibility but ignored – all windows are equally affected.
Initial S/W Revision	Prior to A.02.00

Themes

Accesses a menu of functions that enable you to choose the theme to be used when saving the screen image.

The **Themes** option is the same as the **Themes** option under the **Display** and **Page Setup** dialogs. It allows you to choose between themes to be used when saving the screen image.

Key Path	Save, Screen Image
Remote Command	:MMEMory:STORe:SCReen:THEMe TDColor TDMonochrome FCOLOR FMONochrome :MMEMory:STORe:SCReen:THEMe?
Example	:MMEM:STOR:SCR:THEM TDM
Preset	3D Color; Is not part of Preset, but is reset by Restore Misc Defaults or Restore System Defaults All and survives subsequent running of the modes.
Readback	3D Color 3D Mono Flat Color Flat Mono
Backwards Compatibility Notes	In ESA and PSA we offer the choice of "Reverse Bitmap" or "Reverse Metafile" when saving screen images. This is much like the "Flat Color" theme available in X-Series. Also, if you selected Reverse Bitmap AND a black & white screen image, that would be much like "Flat Monochrome". In other words, each of the X-Series themes has a similar screen image type in ESA/PSA. But they are not identical.
Initial S/W Revision	Prior to A.02.00

3D Color

Selects a standard color theme with each object filled, shaded and colored as designed.

Key Path	Save, Screen Image, Themes
Example	MMEM:STOR:SCR:THEM TDC
Readback	3D Color
Initial S/W Revision	Prior to A.02.00

3D Monochrome

Selects a format that is like 3D color but shades of gray are used instead of colors.

Key Path	Save, Screen Image, Themes
Example	MMEM:STOR:SCR:THEM TDM
Readback	3D Mono
Initial S/W Revision	Prior to A.02.00

Flat Color

Selects a format that is best when the screen is to be printed on an ink printer.

Key Path	Save, Screen Image, Themes
Example	MMEM:STOR:SCR:THEM FCOL
Readback	Flat Color
Initial S/W Revision	Prior to A.02.00

Flat Monochrome

Selects a format that is like Flat Color. But only black is used (no colors, not even gray), and no fill.

Key Path	Save, Screen Image, Themes
Example	MMEM:STOR:SCR:THEM FMON
Readback	Flat Mono
Initial S/W Revision	Prior to A.02.00

I/Q Measured Polar Graph

Provides a combination view of the I/Q polar graph and the Metric Result summary

["I/Q Measured Polar Graph view for Radio Device: BTS" on page 1970](#)

["I/Q Measured Polar Graph view for Radio Device: MS" on page 1972](#)

I/Q Measured Polar Graph view for Radio Device: BTS

There are two windows, Metrics (left) and I/Q Measured Polar Vector graph display (right).

The traces and results of this view are only for one PCG. The traces are not averaged, even if the average is on.

["I/Q Measured Polar Vector window \(Note 1\)" on page 1971](#)

["Numeric Results window \(Note 1\)" on page 1971](#)

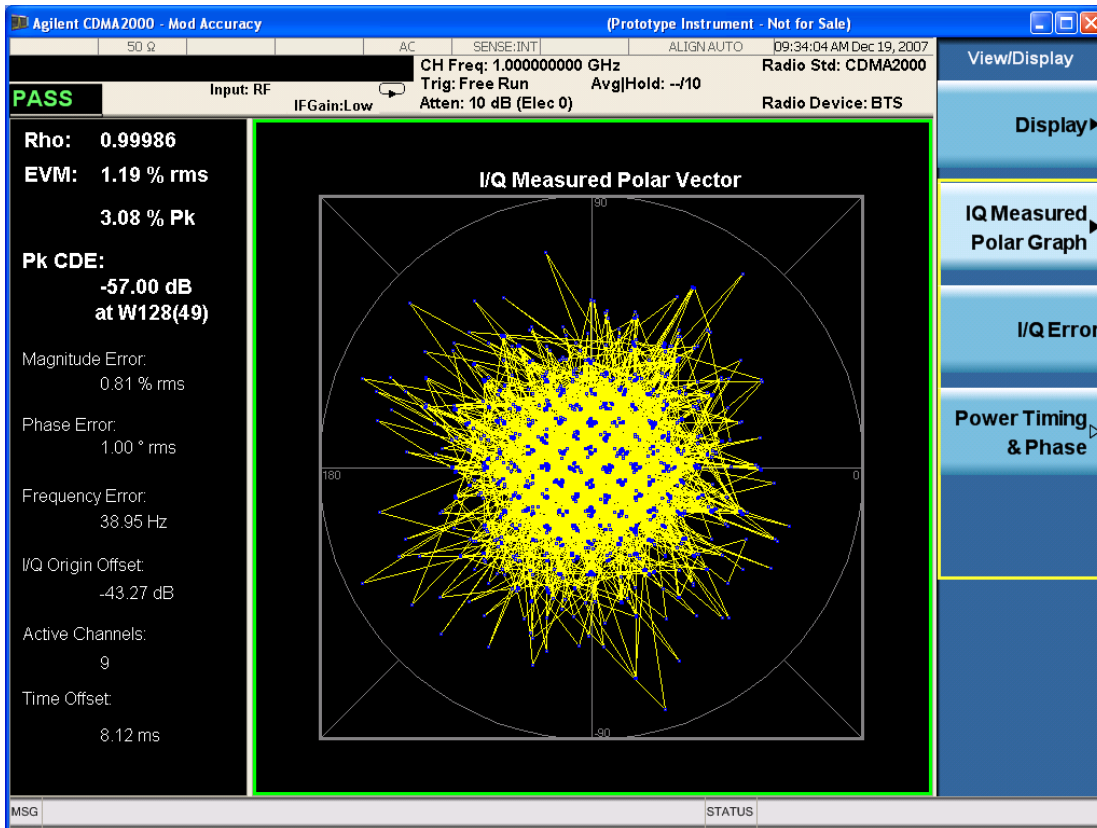

I/Q Measured Polar Vector window (Note 1)

Marker Operation	None
Corresponding Trace	Corrected measured trace (n=5)
Active Channels	n=1 10th a Number of Active Channels.

Note 1: These traces and scalar results are of one PCG. If averaged toggled to On, the scalar results are averaged PVG by PCG, but traces aren't averaged.

Numeric Results window (Note 1)

Name	Corresponding Results	Display Format
Rho	n=1 7th rho	9.99999
EVM (rms)	n=1 1st EVM over the entire measurement area	99.99 % rms
EVM (pk)	n=1 2nd peak EVM in the measurement area	99.99 % pk
Pk CDE (dB)	n=1 8th Peak Code Domain Error relative to the mean	-99.99 dB

	reference power	
Pk CDE Position	n=1 9th Channel number in which the peak code domain error is detected at the max spreading factor.	Wx(Y) x=128 for Forward Link Y: OVSF code number (0 ... 127)
Magnitude Error	n=1 3rd Average magnitude error over the entire measurement area	99.99 % rms
Phase Error	n=1 4th Average phase error over the entire measurement area	99.99 °rms
Freq Error	n=1 6th Frequency error in the measured signal	99.99 Hz
I/Q Origin Offset	n=1 5th I and Q error (magnitude squared) offset from the origin.	-99.99 dB
Active Channels Number	n=1 10th Number of active channels.	10
Time Offset	N=1 11th Pilot phase timing from the acquisition trigger point.	9999.99 us

Note 1: These traces and scalar results are of one PCG. If averaged toggled to On, the scalar results are averaged PVG by PCG, but traces aren't averaged.

I/Q Measured Polar Graph view for Radio Device: MS

There are two windows, Metrics (left) and I/Q Measured Polar Vector graph display (right).

The traces and results of this view are only for one PCG. The traces are not averaged, even if the average is on.

["I/Q Measured Polar Vector window \(Note 1\)" on page 1973](#)

["Numeric Results window \(Note 1\)" on page 1973](#)

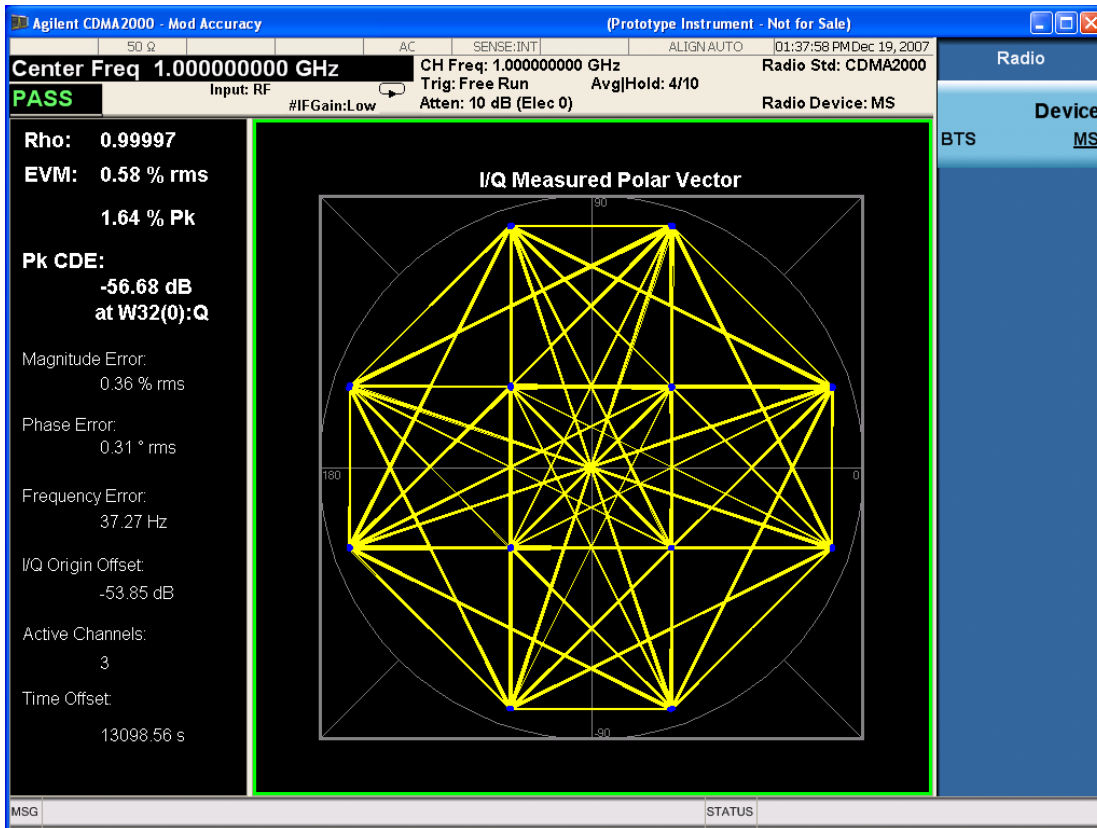

I/Q Measured Polar Vector window (Note 1)

Marker Operation	No
Corresponding Trace	Corrected measured trace (n=5)
Active Channels	n=1 10th a Number of Active Channels.

Note 1: These traces and scalar results are of one PCG. If averaged toggled to On, the scalar results are averaged PVG by PCG, but traces aren't averaged.

Numeric Results window (Note 1)

Name	Corresponding Results	Display Format
Rho	n=1 7th rho	9.99999
EVM (rms)	n=1 1st EVM over the entire measurement area	99.99 % rms
EVM (pk)	n=1 2nd peak EVM in the measurement area	99.99 % pk
Pk CDE (dB)	n=1 8th Peak Code Domain Error relative to the mean	-99.99 dB

	reference power	
Pk CDE Position	n=1 9th Channel number in which the peak code domain error is detected at the max spreading factor.	Wx(Y) x=128 for Forward Link Y: Walsh code number (0 ... 127)
Magnitude Error	n=1 3rd Average magnitude error over the entire measurement area	99.99 % rms
Phase Error	n=1 4th Average phase error over the entire measurement area	99.99 °rms
Freq Error	n=1 6th Frequency error in the measured signal	99.99 Hz
I/Q Origin Offset	n=1 5th I and Q error (magnitude squared) offset from the origin.	-99.99 dB
Active Channels Number	n=1 10th Number of active channels.	10
Time Offset	n=1 11th Pilot phase timing from the acquisition trigger point.	9999.99 us

Note 1: These traces and scalar results are of one PCG. If averaged toggled to On, the scalar results are averaged PVG by PCG, but traces aren't averaged.

Key Path	View/Display
Initial S/W Revision	Prior to A.02.00

I/Q Polar Vec/ConstIn

Specifies the format of the Polar Vector graph display. You can select one of the following formats:

- Vec ConstIn (Vector and Constellation)
- Vector (Vector only)
- Constellation (Constellation only)

Key Path	View/Display, Display
Mode	CDMA2K
Remote Command	:DISPlay:RHO:VIEW[1]:WINDow[1]:TRACe:POLar VC VECTor CONStIn :DISPlay:RHO:VIEW[1]:WINDow[1]:TRACe:POLar?

Example	DISP:RHO:VIEW:WIND1:TRAC:POL CONS DISP:RHO:VIEW:WIND1:TRAC:POL?
Preset	VC
State Saved	Saved in instrument state.
Range	Vec & Constln Vector Constellation
Initial S/W Revision	Prior to A.02.00

Chip Offset

Specifies the number of chips offset from the first chip in a captured PCG.

Key Path	View/Display, Display
Mode	CDMA2K
Remote Command	:DISPlay:RHO:VIEW[1]:WINDow[1]:TRACe:COFFset <integer> :DISPlay:RHO:VIEW[1]:WINDow[1]:TRACe:COFFset?
Example	DISP:RHO:VIEW:WIND1:TRAC:COFF 100 DISP:RHO:VIEW:WIND1:TRAC:COFF?
Preset	0
State Saved	Saved in instrument state.
Min	0
Max	1535 - I/Q chips
Initial S/W Revision	Prior to A.02.00

I/Q Chips

Specifies the number of I/Q chips displayed for the I/Q waveforms.

Key Path	View/Display, Display
Mode	CDMA2K
Remote Command	:DISPlay:RHO:VIEW[1]:WINDow[1]:TRACe:IQCHips <integer> :DISPlay:RHO:VIEW[1]:WINDow[1]:TRACe:IQCHips?
Example	DISP:RHO:VIEW:WIND1:TRAC:IQCH 10 DISP:RHO:VIEW:WIND1:TRAC:IQCH?
Preset	1536
State Saved	Saved in instrument state.
Min	1
Max	1536
Initial S/W Revision	Prior to A.02.00

+45° Rotation

Toggles the display rotation function between On and Off. If set to On, the I/Q polar vector or I/Q polar constellation graph is rotated by +45° to provide a rectangular display.

Key Path	View/Display, Display
Mode	CDMA2K
Remote Command	:DISPlay:RHO:VIEW[1]:WINDow[1]:TRACe:ROTQpi[:STATe] 0 1 OFF ON :DISPlay:RHO:VIEW[1]:WINDow[1]:TRACe:ROTQpi[:STATe] ?
Example	DISP:RHO:VIEW:WIND1:TRAC:ROTQ ON DISP:RHO:VIEW:WIND1:TRAC:ROTQ?
Preset	OFF
State Saved	Saved in instrument state.
Range	On Off
Initial S/W Revision	Prior to A.02.00

Full Vector

Toggles the full vector display function between On and Off. If set to On, the full vector traces, that are shown in gray, are displayed in the background of the polar vector solid traces, which are shown in yellow. Both traces can be interpolated by using the Interpolation key.

Key Path	View/Display, Display
Mode	CDMA2K
Remote Command	:DISPlay:RHO:VIEW[1]:WINDow[1]:TRACe:FVECTor[:STATe] 0 1 OFF ON :DISPlay:RHO:VIEW[1]:WINDow[1]:TRACe:FVECTor[:STATe] ?
Example	DISP:RHO:VIEW:WIND1:TRAC:FVEC ON DISP:RHO:VIEW:WIND1:TRAC:FVEC?
Notes	This key is grayed out if the selected view is I/Q Measured Polar Graph and the selected I/Q Polar Vec/Constln is Constellation.
Preset	OFF
State Saved	Saved in instrument state.
Range	On Off
Initial S/W Revision	Prior to A.02.00

I/Q Error

Provides a combination view of magnitude error, phase error, and EVM. There is no view settings for this view.

"I/Q Error view for Radio Device: BTS" on page 1977

"I/Q Error view for Radio Device: MS" on page 1978

I/Q Error view for Radio Device: BTS

There are three windows, EVM window (upper), Magnitude Error window (middle), Phase Error window (lower),

The traces of this view are not averaged, even if the average function is on.

"EVM window" on page 1977

"Magnitude Error window" on page 1977

"Phase Error window" on page 1978

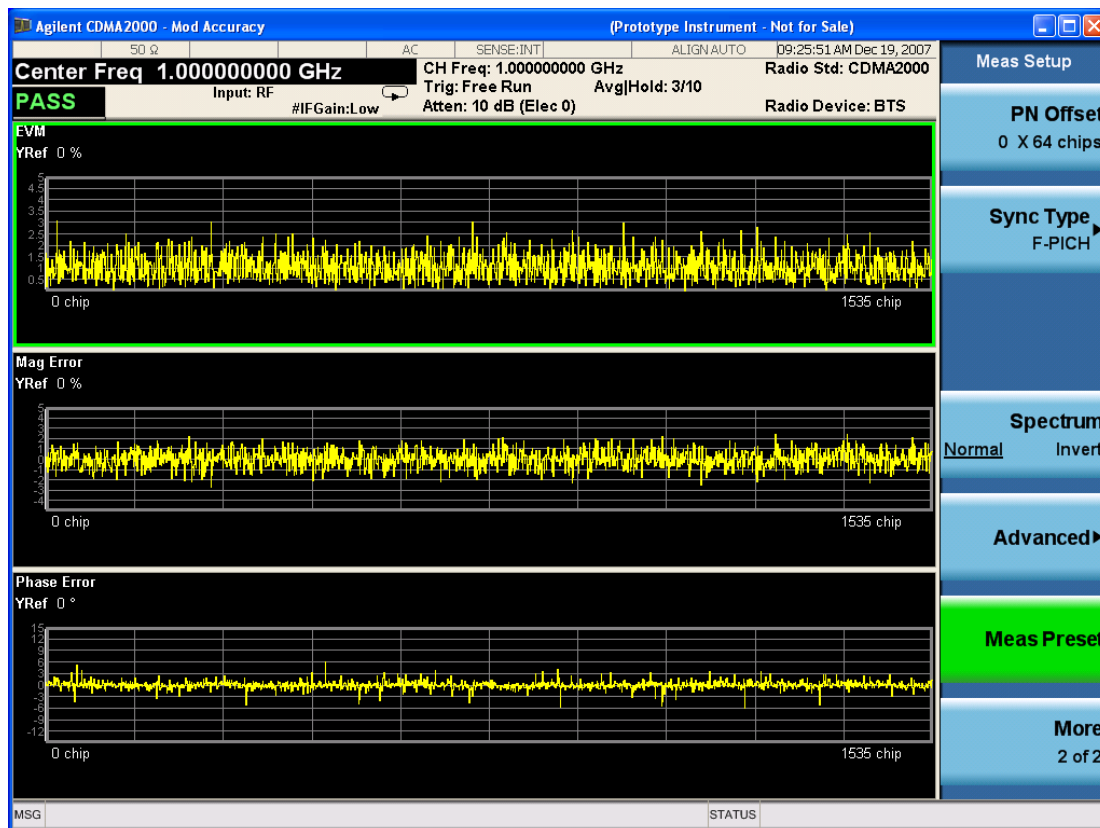

EVM window

Marker Operation	Yes
Corresponding Trace	EVM trace (n=2)

Magnitude Error window

Marker Operation	Yes
Corresponding Trace	Magnitude error trace (n=3)

Phase Error window

Marker Operation	Yes
Corresponding Trace	Phase error trace (n=4)

I/Q Error view for Radio Device: MS

There are three windows, EVM window (upper), Magnitude Error window (middle), Phase Error window (lower),

The traces of this view are not averaged, even if the average function is on.

"EVM window" on page 1978

"Magnitude Error window" on page 1979

"Phase Error window" on page 1979

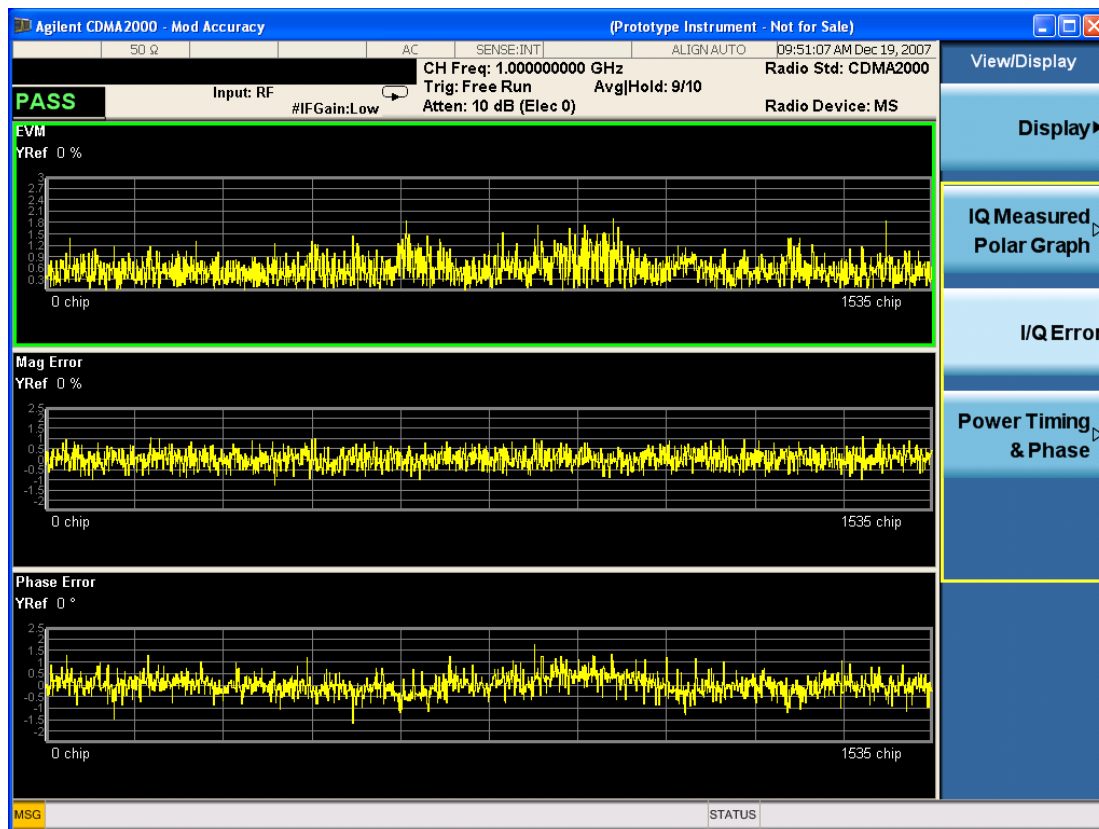

EVM window

Marker Operation	Yes
Corresponding Trace	EVM trace (n=2)

Magnitude Error window

Marker Operation	Yes
Corresponding Trace	Magnitude error trace (n=3)

Phase Error window

Marker Operation	Yes
Corresponding Trace	Phase error trace (n=4)

Key Path	View/Display
Initial S/W Revision	Prior to A.02.00

Power Timing & Phase

Power, Timing and Phase view displays the power of the code channels, and time/phase of the code channels to pilot channel, and also CDE of each code channel using the Multi Channel Estimator. The results of this view are not averaged, even if the average function is on. If Multi Channel Estimator is Off, there will be a message "Press Meas Setup, Advanced and turn Multi Channel Estimation On to see the data" appears on the view of Power, Timing, and Phase.

["Power, Timing, and Phase view for Radio Device: BTS" on page 1979](#)

["Power, Timing and Phase view for Radio Device: MS" on page 1980](#)

Power, Timing, and Phase view for Radio Device: BTS

There is only one window in this view. If you need to see the metric result of power, timing and phase in channel level, you need first turn the Multi-Channel Estimator option to "ON".

- Prev Page - Returns one page back to the previous page of the measurement results.
- Next Page - Moves one page forward to the next page of the measurement results.
- Scroll Up - Moves one line upward from the current page of the measurement results by each pressing.
- Scroll Down - Moves one line downward from the current page of the measurement results by each pressing.
- First Page - Moves from the current page to the first page of the measurement results.
- Last Page - Moves from the current page to the last page of the measurement results.



Power, Timing and Phase view for Radio Device: MS

There is only one window in this view. If you need to see the metric result of power, timing and phase in channel level, you need first turn the Multi-Channel Estimator option to “ON”.

- Prev Page - Returns one page back to the previous page of the measurement results.
- Next Page - Moves one page forward to the next page of the measurement results.
- Scroll Up - Moves one line upward from the current page of the measurement results by each pressing.
- Scroll Down - Moves one line downward from the current page of the measurement results by each pressing.
- First Page - Moves from the current page to the first page of the measurement results.
- Last Page - Moves from the current page to the last page of the measurement results.



Key Path	View/Display
Initial S/W Revision	Prior to A.02.00

Prev Page

Returns the current page back to the previous page of the measurement results.

Key Path	View/Display, Power Timing & Phase
Mode	CDMA2K
Remote Command Notes	NO SCPI
Initial S/W Revision	Prior to A.02.00

Next Page

Moves the current page forward to the next page of the measurement results.

Key Path	View/Display, Power Timing & Phase
Mode	CDMA2K

Remote Command Notes	NO SCPI
Initial S/W Revision	Prior to A.02.00

Scroll Up

Moves one line upward from the current page of the measurement results by each pressing.

Key Path	View/Display, Power Timing & Phase
Mode	CDMA2K
Remote Command Notes	NO SCPI
Initial S/W Revision	Prior to A.02.00

Scroll Down

Moves one line downward from the current page of the measurement results by each press.

Key Path	View/Display, Power Timing & Phase
Mode	CDMA2K
Remote Command Notes	NO SCPI
Initial S/W Revision	Prior to A.02.00

First Page

Moves from the current page to the first page of the measurement results.

Key Path	View/Display, Power Timing & Phase
Mode	CDMA2K
Remote Command Notes	NO SCPI
Initial S/W Revision	Prior to A.02.00

Last Page

Moves from the current page to the last page of the measurement results.

Key Path	View/Display, Power Timing & Phase
Mode	CDMA2K
Remote Command Notes	NO SCPI
Initial S/W Revision	Prior to A.02.00

14 QPSK EVM Measurement

The quadrature phase shift keying (QPSK) error vector magnitude (EVM) measurement is a measure of phase and amplitude modulation quality that relates the performance of the actual signal compared to an ideal signal as a percentage, as calculated over the course of the ideal constellation. These phase and frequency errors are measures of modulation quality for the W-CDMA (3GPP) system, and can be quantified through QPSK EVM measurements. For measurement results and views, see ["View/Display" on page 2211](#).

This topic contains the following sections:

["Measurement Commands for QPSK EVM" on page 1984](#)

["Remote Command Results for QPSK EVM Measurement" on page 1985](#)

Measurement Commands for QPSK EVM

The general functionality of CONFigure, FETCh, MEASure, and READ are described at the beginning of this section. See the SENSE:EVMQpsk commands for more measurement related commands.

```
:CONFigure:EVMQpsk
```

```
:CONFigure:EVMQpsk:NDEFault
```

```
:FETCh:EVMQpsk[n]?
```

```
:READ:EVMQpsk[n]?
```

```
:MEASure:EVMQpsk[n]?
```

For more measurement related commands, see the SENSE subsystem, and the section "[Remote Measurement Functions](#)" on page 2015.

Remote Command Results for QPSK EVM Measurement

n	Results Returned
0	Returns unprocessed I/Q trace data, as a series of comma-separated trace points, in volts.
not specified or n = 1	<p>Returns the following 11 scalar results:</p> <ol style="list-style-type: none"> 1. RMS EVM is a floating point number (in percent) of EVM over the entire measurement area. 2. RMS EVM maximum is the maximum RMS EVM over the average counts. 3. Peak EVM is a floating point number (in percent) of peak EVM in the measurement area. 4. Peak EVM maximum is the maximum peak EVM over the average counts. 5. Magnitude Error is a floating point number (in percent) of averaged magnitude error over the entire measurement area. 6. Magnitude Error maximum is a floating point number over the average counts. 7. Phase Error is a floating point number (in degrees) of the averaged phase error over the entire measurement area. 8. Phase Error maximum is the maximum phase error over the average counts. 9. Frequency Error is a floating point number (in Hz) of the frequency error in the measured signal. 10. Frequency Error maximum is the maximum frequency error over the average counts. 11. I/Q Origin Offset is a floating point number (in dB) of the I and Q error (magnitude squared) offset from the origin.
2	EVM trace – returns a series of floating point numbers (in percent) that represent each sample in the EVM trace. The first number is the symbol 0 decision point. There are X points per symbol (X=points/chip). Therefore, the decision points are at 0, 1*X, 2*X, and so on.
3	Magnitude error trace – returns a series of floating point numbers (in percent) that represent each sample in the magnitude error trace. The first number is the symbol 0 decision point. There are X points per symbol (X=points/chip). Therefore, the decision points are at 0, 1*X, 2*X, ...
4	Phase error trace – returns a series of floating point numbers (in percent) that represent each sample in the phase error trace. The first number is the symbol 0 decision point. There are X points per symbol (X=points/chip). Therefore, the decision points are at 0, 1*X, 2*X, ...
5	<p>Corrected measured trace – returns a series of floating point numbers that alternately represent I and Q pairs of the corrected measured trace. The magnitude of each I and Q pair are normalized to 1.0. The first number is the I sample of symbol 0 decision point and the second number is the Q sample of symbol 0 decision point. There are X points per symbol (X=points/chip). Therefore, the series of numbers is:</p> <p>1st number = I of the symbol 0 decision point 2nd number = Q of the symbol 0 decision point ... (2*X)+1 number = I of the symbol 1 decision point (2*X)+2 number = Q of the symbol 1 decision point ... (2*X)*N+1 th number = I of the symbol N decision point (2*X)*N+2 th number = Q of the symbol N decision point</p>

Key Path	Meas
Initial S/W Revision	Prior to A.02.00

AMPTD Y Scale

Accesses the AMPTD Y Scale menu that allows you to set the desired vertical scale and associated settings for the current measurement.

Key Path	Front-panel key
Initial S/W Revision	Prior to A.02.00

Range

The Range menu allows setting amplitude controls of the instrument.

Key Path	AMPTD Y Scale
Scope	Meas Global
Initial S/W Revision	A.12.50

Range

Represents the amplitude of the largest sinusoidal signal that could be present within the IF without being clipped by the ADC. For signals with high peak-to-average ratios, the range may need to exceed the rms signal power by a fair amount to avoid clipping.

Key Path	Range
Mode	BASIC
Remote Command	[:SENSe] :POWer [:RF] :RANGe <real> [:SENSe] :POWer [:RF] :RANGe?
Example	:POW:RANG 10.0 :POW:RANG?
Notes	The MIN and MAX values are affected by the External Gain parameters, and by the Center Frequency. (The hardware compensates for frequency response and alters the Range setting.)
Preset	0
State Saved	Saved in instrument state.
Min	-100
Max	100
Initial S/W Revision	A.12.50

Adjust Range For Min Clip

Sets the combination of attenuation and gain based on the current measured signal level so that clipping will be at a minimum.

This is an "immediate action" function, that is, it executes once, when the key is pressed.

This key is grayed out in measurements that do not support this functionality.

Key Path	AMPTD Y Scale, Attenuation
Remote Command	<code>[:SENSe] :POWer [:RF] :RANGe:OPTimize IMMEDIATE</code>
Initial S/W Revision	Prior to A.02.00
Modified at S/W Revision	A.03.00

Pre-Adjust for Min Clip

If this function is on, it does the adjustment described under Adjust Range For Min Clip each time a measurement restarts. Therefore, in Continuous measurement mode, it only executes before the first measurement.

Key Path	AMPTD Y Scale, Attenuation
Remote Command	<code>[:SENSe] :POWer [:RF] :RANGe:OPTimize:ATTenuation OFF ON ELEctrical COMBined</code> <code>[:SENSe] :POWer [:RF] :RANGe:OPTimize:ATTenuation?</code>
Notes	This parameter is shared with old XA platform which uses AutoAtten. To keep the backward compatibility, ELEctrical and COMBined still can be used. Then, upon receiving ELEctrical and COMBined, these enums will be interpreted as aliases of ON. Then, when queried, ON will be returned.
Preset	OFF for Swept SA measurement; ON for all other measurements that support Pre-Adjust for Min Clip
State Saved	Saved in instrument state
Initial S/W Revision	Prior to A.02.00
Modified at S/W Revision	A.03.00

Peak to Average

The Peak to Average Ratio is used with the Range setting to optimize the level control in the instrument. The value is the ratio, in dB, of the peak power to the average power of the signal to be measured. A ratio of 0 should be used for sinusoidal signals; for 802.11g OFDM signals use 9 dB.

All Applications (Modes) will show the current value of Peak to Average ratio on the softkey. However, some applications will not permit changing the value. In these situations the softkey will be grayed-out.

Key Path	AMPTD Y Scale, Range
Remote Command	<code>[:SENSe] :POWer [:RF] :RANGe:PARatio <real></code> <code>[:SENSe] :POWer [:RF] :RANGe:PARatio?</code>
Example	POW:RANG:PAR 12 dB
Notes	In some Applications (Modes) this parameter will be read-only; meaning the value will appear on the softkey and query via SCPI, but not changeable. In such applications the softkey will be grayed-out. Attempting to change the value via SCPI will be ignored and no error message will be generated.

Preset	10 dB
State Saved	Saved in instrument state
Min	0 dB
Max	20 dB
Initial S/W Revision	A.13.00

Mixer Level Offset

Mixer level offset is an advanced setting to adjust target Range at the input mixer which in turn affects the signal level in the instrument's IF. This setting can be used when additional optimization is needed after setting Peak to Average ratio. Positive values of offset optimize noise performance over distortion, negative values optimize distortion performance over noise.

Key Path	AMPTD Y Scale, Range
Remote Command	[:SENSe] :POWer [:RF] :RANGe :MIXer :OFFSet <real> [:SENSe] :POWer [:RF] :RANGe :MIXer :OFFSet?
Example	POW:RANG:MIX:OFFS -5 dB
Preset	0 dB
State Saved	Saved in instrument state
Min	-35 dB
Max	30 dB
Initial S/W Revision	A.13.00

Presel Center

When this key is pressed, the centering of the preselector filter is adjusted to optimize the amplitude accuracy at the frequency of the selected marker.

See AMPTD Y Scale, [Presel Center](#) for more information.

This is only available when the selected input is RF.

Key Path	AMPTD/Y Scale
Initial S/W Revision	Prior to A.02.00

Presel Adjust

Allows you to manually adjust the preselector filter frequency to optimize its response to the signal of interest. This function is only available when Presel Center is available.

See AMPTD Y Scale, [Preselector Adjust](#) for more information.

This is only available when the selected input is RF.

Key Path	AMPTD/Y Scale
Initial S/W Revision	Prior to A.02.00

Auto Couple

The Auto Couple feature provides a quick and convenient way to automatically couple multiple instrument settings. This helps ensure accurate measurements and optimum dynamic range. When the Auto Couple feature is activated, either from the front panel or remotely, all parameters of the current measurement that have an Auto/Manual mode are set to Auto mode and all measurement settings dependent on (or coupled to) the Auto/Man parameters are automatically adjusted for optimal performance.

However, the Auto Couple key actions are confined to the current measurement only. It does not affect other measurements in the mode, and it does not affect markers, marker functions, or trace or display attributes.

See "[More Information](#)" on page 1991

Key Path	Front-panel key
Remote Command	:COUPle ALL NONE
Example	:COUP ALL
Notes	:COUPle ALL puts all Auto/Man parameters in Auto mode (equivalent to pressing the Auto Couple key). :COUPLE NONE puts all Auto/Man parameters in manual mode. It decouples all the coupled instrument parameters and is not recommended for making measurements.
Initial S/W Revision	Prior to A.02.00

More Information

There are two types of functions that have Auto/Manual modes.

Auto/Man Active Function keys

An Auto/Man toggle key controls the binary state associated with an instrument parameter by toggling between Auto (where the parameter is automatically coupled to the other parameters it is dependent upon) and Man (where the parameter is controlled independent of the other parameters), as well as making the parameter the active function. The current mode is indicated on the softkey with either Auto or Man underlined as illustrated below.

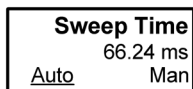

vsd07

Auto/Man 1-of-N keys

An Auto/Man 1-of-N key allows you to manually pick from a list of parameter values, or place the function in Auto, in which case the value is automatically selected (and indicated) as shown below. If in Auto, Auto is underlined on the calling key. If in manual operation, manual is indicated on the calling key. But the calling key does not actually toggle the function, it simply opens the menu.

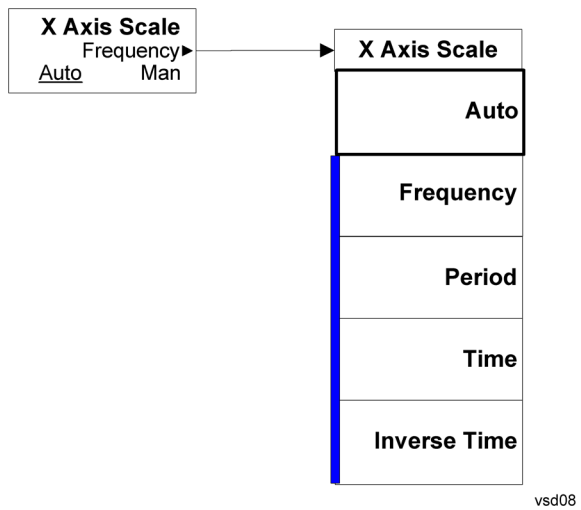

BW

Accesses a menu of functions that enable you to specify and control the Info BW.

Key Path	Front-panel key
Initial S/W Revision	Prior to A.02.00

Info BW

Activates the Info BW function, which enables you to manually set the information bandwidth of the analyzer. This is used to set the hardware filter of the ADC.

Key Path	BW
Mode	WCDMA, C2K, 1xEVDO
Remote Command	<code>[:SENSe] :EVMQpsk :BANDwidth [:RESolution] <freq></code> <code>[:SENSe] :EVMQpsk :BANDwidth [:RESolution] ?</code>
Example	EVMQ:BAND 1 kHz EVMQ:BAND?
Notes	The values shown in this table reflect the conditions after a Mode Preset.
Preset	WCDMA: 6 MHz CDMA1xEVDO, C2K: 1.5MHz
State Saved	Saved in instrument state.
Min	1 kHz
Max	Hardware Dependent: RF Input: No Option = 10 MHz WB (25 MHz or wider) = Hardware Option Limit I/Q Input (for I+jQ) No Option = 20 MHz OptionB25 = 50 MHz
Backwards Compatibility SCPI	<code>[:SENSe] :EVMQpsk :BWIDth [:RESolution]</code>
Initial S/W Revision	Prior to A.02.00
Modified at S/W Revision	A.06.00

Info BW Control

Accesses a menu that enables you to select either A Gaussian or Flat Top filter.

Key Path	BW
Initial S/W Revision	Prior to A.02.00

Filter Type

Selects the type of bandwidth filter that is used. The choices are Gaussian or Flat top.

Key Path	BW, RBW Control
Mode	WCDMA, C2K, 1xEVDO
Remote Command	[:SENSe] :EVMQpsk :BANDwidth :SHAPE GAUSSian FLATtop [:SENSe] :EVMQpsk :BANDwidth :SHAPE?
Example	EVMQ:BAND:SHAP GAUS EVMQ:BAND:SHAP?
Preset	FLATtop
State Saved	Saved in instrument state.
Range	Gaussian FlatTop
Backwards Compatibility SCPI	[:SENSe] :EVMQpsk :BWIDth :SHAPE
Initial S/W Revision	Prior to A.02.00

Cont (Continuous Measurement/Sweep)

Sets the analyzer for Continuous measurement operation. The single/continuous state is Meas Global so the setting will affect all measurements. If you are Paused, pressing Cont does a Resume.

Key Path	Front-panel key
Remote Command	:INITiate:CONTinuous OFF ON 0 1 :INITiate:CONTinuous?
Example	:INIT:CONT 0 puts analyzer in Single measurement operation. :INIT:CONT 1 puts analyzer in Continuous measurement operation
Preset	ON (Note that SYST:PRESet sets INIT:CONT to ON but *RST sets INIT:CONT to OFF)
State Saved	Saved in instrument state
Backwards Compatibility Notes	For Spectrum Analysis mode in ESA and PSA, there is no Cont hardkey, instead there is a Sweep Single/Cont key. In these analyzers, switching the Sweep Single/Cont key from Single to Cont restarts averages (displayed average count reset to 1), but does not restart Max Hold and Min Hold. The X-Series has Single and Cont keys in place of the SweepSingleCont key. In the X-Series, if in single measurement, the Cont key (and INIT:CONT ON) switches to continuous measurement, but never restarts a measurement and never resets a sweep.
Initial S/W Revision	Prior to A.02.00

In Swept SA Measurement (Spectrum Analysis Mode):

The analyzer takes repetitive sweeps, averages, measurements, etc., when in Continuous mode. When the average count reaches the Average/Hold Number the count stops incrementing, but the analyzer keeps sweeping. See the Trace/Detector section for the averaging formula used both before and after the Average/Hold Number is reached. The trigger condition must be met prior to each sweep. The type of trace processing for multiple sweeps, is set under the Trace/Detector key, with choices of Trace Average, Max Hold, or Min Hold.

In Other Measurements/Modes:

With Avg/Hold Num (in the Meas Setup menu) set to Off or set to On with a value of 1, a sweep is taken after the trigger condition is met; and the analyzer continues to take new sweeps after the current sweep has completed and the trigger condition is again met. However, with Avg/Hold Num set to On with a value >1, multiple sweeps (data acquisitions) are taken for the measurement. The trigger condition must be met prior to each sweep. The sweep is not stopped when the average count k equals the number N set for Avg/Hold Num is reached, but the number k stops incrementing. A measurement average usually applies to all traces, marker results, and numeric results. But sometimes it only applies to the numeric results.

If the analyzer is in Single measurement, pressing the Cont key does not change k and does not cause the sweep to be reset; the only action is to put the analyzer into Continuous measurement operation.

If it is already in continuous sweep:

the INIT:CONT 1 command has no effect

14 QPSK EVM Measurement
Cont (Continuous Measurement/Sweep)

the INIT:CONT 0 command will place the analyzer in Single Sweep but will have no effect on the current sequence until $k = N$, at which point the current sequence will stop and the instrument will go to the idle state.

File

See "File" on page 184

FREQ Channel

Accesses a menu of keys that allow you to control the Frequency and Channel parameters of the instrument.

Some features in the Frequency menu are the same for all measurements – they do not change as you change measurements. Settings like these are called “Meas Global” and are unaffected by Meas Preset. For example, the Center Freq setting is the same for all measurements - it does not change as you change measurements.

Key Path	Front-panel key
Initial S/W Revision	Prior to A.02.00

Center Freq

Sets the frequency that corresponds to the horizontal center of the graticule (when frequency Scale Type is set to linear). While adjusting the Center Frequency the Span is held constant, which means that both Start Frequency and Stop Frequency will change.

Pressing Center Freq also sets the frequency entry mode to Center/Span. In Center/Span mode, the center frequency and span values are displayed below the graticule, and the default active function in the Frequency menu is Center Freq.

The center frequency setting is the same for all measurements within a mode, that is, it is Meas Global. Some modes are also able to share a Mode Global center frequency value. If this is the case, the Mode will have a Global Settings key in its Mode Setup menu.

The Center Freq function sets (and queries) the Center Frequency for the currently selected input. If your analyzer has multiple inputs, and you select another input, the Center Freq changes to the value for that input. SCPI commands are available to directly set the Center Freq for a specific input.

Center Freq is remembered as you go from input to input. Thus you can set a Center Freq of 10 GHz with the RF Input selected, change to BBIQ and set a Center Freq of 20 MHz, then switch to External Mixing and set a Center Freq of 60 GHz, and when you go back to the RF Input the Center Freq will go back to 10 GHz; back to BBIQ and it is 20 MHz; back to External Mixing and it is 60 GHz.

See ["RF Center Freq" on page 2001](#)

See [Ext Mix Center Freq](#)

See ["I/Q Center Freq" on page 2003](#)

See ["Center Frequency Presets" on page 1999](#)

Key Path	FREQ Channel
Scope	Meas Global
Remote Command	<code>[:SENSe] :FREQuency:CENTer <freq></code> <code>[:SENSe] :FREQuency:CENTer?</code>
Example	<code>FREQ:CENT 50 MHz</code>

	FREQ:CENT UP changes the center frequency to 150 MHz if you use FREQ:CENT:STEP 100 MHz to set the center frequency step size to 100 MHz FREQ:CENT?
Notes	This command sets either the RF or I/Q Center Frequency depending on the selected input. For RF input it is equivalent to FREQ:RF:CENT For I/Q input it is equivalent to FREQ:IQ:CENT Preset and Max values are dependent on Hardware Options (5xx) If no terminator (e.g. MHz) is sent the terminator Hz is used. If a terminator with unit other than Frequency is used, an invalid suffix error message is generated.
Dependencies	The Center Frequency can be limited by Start or Stop Freq limits, if the Span is so large that Start or Stop reach their limit.
Couplings	When operating in "swept span", any value of the Center Frequency or Span that is within the frequency range of the analyzer is allowed when the value is being set through the front panel numeric key pad or the SCPI command. The other parameter is forced to a different value if needed, to keep the Start and the Stop Frequencies within the analyzer's frequency range
Preset	Depends on instrument maximum frequency, mode, measurement, and selected input. See "Center Frequency Presets" on page 1999 and "RF Center Freq" on page 2001 and Ext Mix Center Freq and "I/Q Center Freq" on page 2003.
State Saved	Saved in instrument state
Min	Depends on instrument maximum frequency, mode, measurement, and selected input.. See "Center Frequency Presets" on page 1999 and "RF Center Freq" on page 2001 and "I/Q Center Freq" on page 2003.
Max	Depends on instrument maximum frequency, mode, measurement, and selected input.. See "Center Frequency Presets" on page 1999 and "RF Center Freq" on page 2001 and "I/Q Center Freq" on page 2003.
Default Unit	Hz
Status Bits/OPC	Non-overlapped
Dependencies	
Initial S/W Revision	Prior to A.02.00

Center Frequency Presets

The following table provides the Center Frequency Presets for the Spectrum Analyzer mode, and the Max Freq, for the various frequency options:

Freq Option	CF after Mode Preset	Stop Freq after Mode Preset	Max Freq (can't tune above)

14 QPSK EVM Measurement
 FREQ Channel

503 (all but N9000A)	1.805 GHz	3.6 GHz	3.7 GHz
503 (N9000A)	1.505 GHz	3.0 GHz	3.08 GHz
504 (M9420A)	1 GHz	3.8GHz	3.88 GHz
506 (M9420A)	1 GHz	6.0GHz	6.08 GHz
507 (all but N9000A)	3.505 GHz	7.0 GHz	7.1 GHz
507 (N9000A)	3.755 GHz	7.5 GHz	7.58 GHz
508 (all but N9038A)	1.805 GHz	3.6 GHz	8.5 GHz
508 (N9038A)	4.205 GHz	8.4 GHz	8.5 GHz
513	6.805 GHz	13.6 GHz	13.8 GHz
526 (all but N9000A and N9038A)	13.255 GHz	26.5 GHz	27.0 GHz
526 (N9000A)	13.255 GHz	26.5 GHz	26.55 GHz
526 (N9038A)	1.805 GHz	3.6 GHz	27.0 GHz
532	16.005 GHz	32.0 GHz	32.5 GHz
543	21.505 GHz	43.0 GHz	TBD
544	22.005 GHz	44.0 GHz	44.5 GHz
550	25.005 GHz	50.0 GHz	51 GHz

Input 2:

Model	CF after Mode Preset	Stop Freq after Mode Preset	Max Freq (can't tune above)
N9000A opt C75	0.7505GHz	1.5 GHz	1.58 GHz
N9038A	505 MHz	1 GHz	1.000025 GHz

Tracking Generator Frequency Limits (N9000A only):

Tracking Generator Option	Min Freq (clips to this freq when turn TG on and can't tune below while TG on)	If above this Freq, Stop Freq clipped to this Freq when TG turned on	Max Freq (can't tune above) while TG on
T03	9 kHz	3.0 GHz	3.08 GHz
T06	9 kHz	6.0 GHz	6.05 GHz

The following table shows the Center Frequency Presets for modes other than Spectrum Analyzer:

Mode	CF Preset for RF
WCDMA	1 GHz
WIMAXOFDMA,	1 GHz
BASIC	1 GHz
ADEMOD	1 GHz
VSA	1 GHz
TDSCDMA	1 GHz
PNOISE	1 GHz
LTE	1 GHz
LTETDD	1 GHz
MSR	1 GHz
GSM	935.2 MHz
NFIGURE	1.505 GHz

RF Center Freq

SCPI command for specifying the RF Center Frequency. This command will set the Center Frequency to be used when the RF input is selected, even if the RF input is not the input that is selected at the time the command is sent. Note that the Center Freq function in the Frequency menu on the front panel always applies to the currently selected input.

Scope	Meas Global
Remote Command	<code>[:SENSe] :FREQuency:RF:CENTer <freq></code> <code>[:SENSe] :FREQuency:RF:CENTer?</code>
Example	FREQ:RF:CENT 30 MHz
Notes	This command is the same in all modes, but the parameter is Measurement Global. So the value is independent in each mode and common across all the measurements in the mode.
Dependencies	If the electronic/soft attenuator is enabled, any attempt to set Center Frequency such that the Stop Frequency would be >3.6 GHz fails and results in an advisory message. If the equivalent SCPI

	command is sent, this same message is generated as part of a “-221, Settings conflict” warning. If Source Mode is set to Tracking, and the Max or Min Center Freq is therefore limited by the limits of the source, a warning message is generated, “Data out of range;clipped to source max/min” if these limits are exceeded. Note that for an external source, these limits can be affected by the settings of Source Numerator, Source Denominator and Power Sweep.
Preset	See table above
State Saved	Saved in instrument state.
Min	-79.999995 MHz, unless Source Mode is set to Tracking, in which case it is limited by the minimum frequency of the Source
Max	See table above. Basically instrument maximum frequency – 5 Hz. Note that, if the Source Mode is set to Tracking, the effective instrument maximum frequency may be limited by the source maximum frequency. If the knob or step keys are being used, also depends on the value of the other three interdependent parameters Span, Start Frequency and Stop Frequency
Initial S/W Revision	Prior to A.02.00
Modified at S/W Revision	A.03.00

Ext Mix Center Freq

SCPI command for specifying the External Mixer Center Frequency. This command will set the Center Frequency to be used when the External Mixer is selected, even if the External Mixer input is not the input which is selected at the time the command is sent. Note that the Center Freq function in the Frequency menu on the front panel always applies to the currently selected input.

Scope	Meas Global
Remote Command	<code>[:SENSE] :FREQuency:EMIXer:CENTer <freq></code> <code>[:SENSE] :FREQuency:EMIXer:CENTer?</code>
Example	<code>:FREQ:EMIX:CENT 60 GHz</code> <code>:FREQ:EMIX:CENT?</code>
Notes	This command is the same in all modes, but the parameter is Measurement Global. So the value is independent in each mode and common across all the measurements in the mode.
Couplings	When returning to External Mixing after having been switched to one of the other inputs (e.g., RF), you will come back into the settings that you had when you left External Mixing. So you will come back to the band you were in with the Center Frequency that you had. However, Span is not an input-dependent parameter, therefore you will bring the span over from the other input. Therefore, the analyzer comes back with the span from the previous input, limited as necessary by the current mixer setup.
Preset	When a Mode Preset is performed while in External Mixing, the Start frequency of the current Mode is set to the nominal Min Freq of the lowest harmonic range in the Harmonic Table for the current mixer setup. Similarly, the Stop frequency of the current Mode is set to the nominal Max Freq of the highest harmonic range in the Harmonic Table. The Center Freq thus presets to the point arithmetically equidistant from these two frequencies.

If the current measurement has a limited Span available to it, and cannot achieve the Span shown in the table (Span=Stop Freq - Start Freq), the analyzer uses the maximum Span the measurement allows, and still sets the Center Freq to the midpoint of the Start and Stop Freq values in the Harmonic Table.

When Restore Input/Output Defaults is performed, the mixer presets to the 11970A, whose Start and Stop frequencies are 26.5 and 40 GHz respectively. The center of these two frequencies is 33.25 GHz.

Therefore, after a Restore Input/Output Defaults, if you go into External Mixing and do a Mode Preset while in the Spectrum Analyzer Mode, the resulting Center Freq is 33.25 GHz.

State Saved	Saved in instrument state.
Min	The minimum frequency in the currently selected mixer band + 5 Hz
Max	The maximum frequency in the currently selected mixer band - 5 Hz If the knob or step keys are being used, also depends on the value of the other three interdependent parameters Span, Start Frequency and Stop Frequency
Initial S/W Revision	A.08.01

I/Q Center Freq

SCPI command for specifying the I/Q Center Frequency. This command will set the Center Frequency to be used when the I/Q input is selected, even if the I/Q input is not the input which is selected at the time the command is sent. Note that the Center Freq function in the Frequency menu on the front panel always applies to the currently selected input.

Scope	Meas Global
Remote Command	[:SENSe] :FREQuency:IQ:CENTer <freq> [:SENSe] :FREQuency:IQ:CENTer?
Example	FREQ:IQ:CEN: 30 MHz
Notes	This command is the same in all modes, but the parameter is Measurement Global. So the value is independent in each mode and common across all the measurements in the mode.
Preset	0 Hz
State Saved	Saved in instrument state.
Min	-40.049995 MHz
Max	40.049995 MHz
Initial S/W Revision	Prior to A.02.00

CF Step

Changes the step size for the center frequency and start and stop frequency functions. Once a step size has been selected and the center frequency function is active, the step keys (and the UP|DOWN parameters for Center Frequency from remote commands) change the center frequency by the step-size value. The step size function is useful for finding harmonics and sidebands beyond the current frequency span of the analyzer.

Note that the start and stop frequencies also step by the CF Step value.

Key Path	FREQ Channel
Remote Command	[:SENSe]:FREQuency:CENTer:STEP[:INCRement] <freq> [:SENSe]:FREQuency:CENTer:STEP[:INCRement]? [:SENSe]:FREQuency:CENTer:STEP:AUTO OFF ON 0 1 [:SENSe]:FREQuency:CENTer:STEP:AUTO?
Example	FREQ:CENT:STEP:AUTO ON FREQ:CENT:STEP 500 MHz FREQ:CENT UP increases the current center frequency value by 500 MHz FREQ:CENT:STEP? FREQ:CENT:STEP:AUTO?
Notes	Preset and Max values are depending on Hardware Options (503, 507, 508, 513, 526)
Notes	Preset and Max values are dependent on Hardware Options (5xx)
Dependencies	Freq Offset is not available in External Mixing. In this case the Freq Offset key is grayed out and shows a value of zero. It will once again be available, and show the previously set value, when you return to the RF Input.
Dependencies	Span, RBW, Center frequency If the electronic/soft attenuator is enabled, any attempt to change the value of the center frequency >3.6 GHz by pressing the Up-arrow key, fails and results in an advisory message. If the equivalent SCPI command is sent, this same message is generated as part of a “-221, Settings conflict” warning.
Couplings	When auto-coupled in a non-zero span, the center frequency step size is set to 10% of the span. When auto-coupled in zero span, the center frequency step size is set to the equivalent -3 dB RBW value.
Preset	Auto ADEMODO: 1 MHz ON
State Saved	Saved in instrument state
Min	– (the maximum frequency of the instrument). That is, 27 GHz max freq instrument has a CF step range of +/- 27 GHz. Note that this is the maximum frequency given the current settings of the instrument, so in External Mixing, for example, it is the maximum frequency of the current mixer band.
Max	The maximum frequency of the instrument. That is, 27 GHz max freq instrument has a CF step range of +/- 27 GHz. Note that this is the maximum frequency given the current settings of the instrument, so in External Mixing, for example, it is the maximum frequency of the current mixer band.
Default Unit	Hz
Status Bits/OPC dependencies	non-overlapped
Initial S/W Revision	Prior to A.02.00
Modified at S/W Revision	A.03.00

Input/Output

See "[Input/Output](#)" on page 138

Marker

Accesses a menu that enables you to select, set up and control the markers for the current measurement.

Key Path	Front-panel key
Initial S/W Revision	Prior to A.02.00

Select Marker

Displays 12 markers available for selection.

Key Path	Marker
Initial S/W Revision	Prior to A.02.00

Marker Type

Sets the marker control mode. If the selected marker is Off, pressing Marker sets it to Normal and places it at the center of the screen on the trace determined by the Marker Trace rules. At the same time, reference value of the selected marker appears on the Active Function area. It is:

Marker Chip Value, at I/Q Polar

Marker X Axis Value, at EVM, Phase Error and Mag Error

Default Active Function: the active function for the selected marker's current control mode. If the current control mode is Off, there is no active function and the active function is turned off.

Key Path	Marker
Mode	WCDMA, C2K, 1xEVDO
Remote Command	:CALCulate:EVMQpsk:MARKer [1] 2 . . . 12:MODE POSition DELTA OFF :CALCulate:EVMQpsk:MARKer [1] 2 . . . 12:MODE?
Example	CALC:EVMQ:MARK:MODE POS CALC:EVMQ:MARK:MODE?
Notes	If the selected marker is Off, pressing Marker sets it to Normal and places it at the center of the screen on the trace determined by the Marker Trace rules. At the same time, reference value of the selected marker appears on the Active Function area. It is: Marker Chip Value, at I/Q Polar Marker X Axis Value, at EVM, Phase Error and Mag Error Default Active Function: the active function for the selected marker's current control mode. If the current control mode is Off, there is no active function and the active function is turned off. If the selected marker's trace is I/Q Polar, Delta is not supported. If DELTA is selected on the marker of the I/Q Polar, the command is ignored.

Preset	OFF
State Saved	Saved in instrument state.
Range	Normal Delta Off
Initial S/W Revision	Prior to A.02.00

Marker Properties

Accesses a menu of functions that enable you to specify and control markers for the current measurement.

Key Path	Marker
Initial S/W Revision	Prior to A.02.00

Select Marker

Displays 12 markers available for selection.

Key Path	Marker
Initial S/W Revision	Prior to A.02.00

Relative To

Selects the marker the selected marker will be relative to (its reference marker).

Key Path	Marker, Properties
Mode	WCDMA, C2K, 1xEVDO
Remote Command	:CALCulate:EVMQpsk:MARKer[1] 2 ...12:REFerence <integer> :CALCulate:EVMQpsk:MARKer[1] 2 ...12:REFerence?
Example	CALC:EVMQ:MARK:REF 4 CALC:EVMQ:MARK:REF?
Notes	A marker cannot be relative to itself so that choice is grayed out, and if sent from SCPI generates error -221: "Settings conflict; marker cannot be relative to itself." When queried, a single value is returned (the specified marker numbers relative marker).
Preset	2 3 4 5 6 7 8 9 10 11 12 1
State Saved	Saved in instrument state.
Min	1
Max	12
Initial S/W Revision	Prior to A.02.00

Marker Trace

Assigns the specified marker to the designated trace.

Key Path	Marker
Mode	WCDMA, C2K, 1xEVDO
Remote Command	:CALCulate:EVMQpsk:MARKer[1] 2 ...12:TRACe POLar EVM PERRor MERRor :CALCulate:EVMQpsk:MARKer[1] 2 ...12:TRACe?
Example	CALC:EVMQ:MARK:TRAC MERR CALC:EVMQ:MARK:TRAC?
Notes	Assigns the specified marker to the designated trace.
Preset	POLar
State Saved	Saved in instrument state.
Range	I/Q Polar EVM Phase Error Mag Error
Initial S/W Revision	Prior to A.02.00
Modified at S/W Revision	A.08.00

Couple Marker

Toggles the state of the markers to be coupled On or Off. When this function is true (On), moving any marker causes an equal X-axis movement of every other marker except those located to the polar trace, and Chip value of the marker located to the polar trace, which is not Off, including Fixed markers. "Equal X Axis movement" refers to the difference between each marker's X Axis value (in the fundamental x-axis units of the trace that marker is on) and the X Axis value of the marker being moved (in the same fundamental x-axis units). This may result in markers going off screen

See Couple Marker in the "Marker" section for more information.

Key Path	Marker
Mode	WCDMA, C2K, 1xEVDO
Remote Command	:CALCulate:EVMQpsk:MARKer:COUple[:STATe] ON OFF 1 0 :CALCulate:EVMQpsk:MARKer:COUple[:STATe]?
Example	CALC:EVMQ:MARK:COUP ON CALC:EVMQ:MARK:COUP?
Notes	In QPSK EVM, this marker behaves specially. Coupled values are "Chips" of the markers located to the polar trace, and "X" of the markers located to the other traces than the polar trace.
Preset	OFF
State Saved	Saved in instrument state.
Range	On Off
Initial S/W Revision	Prior to A.02.00

All Markers Off

Turns off all markers.

Key Path	Marker
Mode	WCDMA, C2K, 1xEVDO
Remote Command	:CALCulate:EVMQpsk:MARKer:AOFF
Example	CALC:EVMQ:MARK:AOFF
Initial S/W Revision	Prior to A.02.00

Marker X Axis Value (Remote Command only)

Sets the marker X Axis value in the current marker X Axis Scale unit. It has no effect if the control mode is Off, but is the SCPI equivalent of entering an X value if the control mode is Normal or Delta.

This parameter has different meaning between the cases where the marker trace is set to I/Q Polar and others. In the I/Q Polar Graph, X Axis Value is also the measured value and this command is query only.

Mode	WCDMA, C2K, 1xEVDO
Remote Command	:CALCulate:EVMQpsk:MARKer[1] 2 ...12:X <real> :CALCulate:EVMQpsk:MARKer[1] 2 ...12:X?
Example	CALC:EVMQ:MARK3:X 1280 CALC:EVMQ:MARK3:X?
Notes	If no suffix is sent, it uses the fundamental units for the current marker X Axis Scale. If a suffix is sent that does not match the current marker X Axis Scale unit, an error "Invalid suffix" is generated. If the specified marker is Fixed and a Marker Function is on, error -221 "Settings conflict; cannot adjust Fixed marker while Marker Function is on" is generated. The query returns the marker's absolute X Axis value if the control mode is Normal, or the offset from the marker's reference marker if the control mode is Delta. The query is returned in the fundamental units for the current marker X Axis scale: Hz for Frequency and Inverse Time, seconds for Period and Time. If the marker is Off the response is not a number. This parameter has different meaning between the cases where the marker trace is set to I/Q Polar and others. In the I/Q Polar Graph, X Axis Value is also the measured value and the command is query only.
Preset	After a preset, all Markers are turned OFF, so Marker X Axis Value query returns a Not A Number (NAN).
State Saved	No
Min	-9.9E+37
Max	9.9E+37
Initial S/W Revision	Prior to A.02.00

Marker Chip Value (Remote Command only)

Sets the marker Chip value in the current marker for the trace of I/Q Polar. It has no effect if the control mode is Off, but is the SCPI equivalent of entering a Chip value if the control mode is Normal or Delta.

In other traces than I/Q Polar, this command is meaningless and ignored.

Mode	WCDMA, C2K, 1xEVDO
Remote Command	:CALCulate:EVMQpsk:MARKer[1] 2 ...12:CHIP <real> :CALCulate:EVMQpsk:MARKer[1] 2 ...12:CHIP?
Example	CALC:EVMQ:MARK3:X 0 CALC:EVMQ:MARK3:X?
Notes	If no suffix is sent it uses the fundamental units for the current marker X Axis Scale. If a suffix is sent that does not match the current marker X Axis Scale unit, an error "Invalid suffix" is generated. If the specified marker is Fixed and a Marker Function is on, error -221 "Settings conflict; cannot adjust Fixed marker while Marker Function is on" is generated. The query returns the marker's absolute X Axis value if the control mode is Normal, or the offset from the marker's reference marker if the control mode is Delta. The query is returned in the fundamental units for the current marker X Axis scale: Hz for Frequency and Inverse Time, seconds for Period and Time. If the marker is Off the response is Not A Number. This parameter is only available in the case where the marker trace is set to I/Q Polar.
Preset	0
State Saved	No
Min	-9.9E+37
Max	9.9E+37
Initial S/W Revision	Prior to A.02.00

Marker X Axis Position (Remote Command only)

Sets the marker X position in trace points. It has no effect if the control mode is Off, but is the SCPI equivalent of entering a value if the control mode is Normal or Delta except in trace points rather than X Axis Scale units. The entered value is immediately translated into the current X Axis Scale units for setting the value of the marker.

If the Marker Trace is set to I/Q Polar (POLar), this command provides no effects.

Mode	WCDMA, C2K, 1xEVDO
Remote Command	:CALCulate:EVMQpsk:MARKer[1] 2 ...12:X:POSition <real> :CALCulate:EVMQpsk:MARKer[1] 2 ...12:X:POSition?
Example	CALC:EVMQ:MARK:X:POS 0.0 CALC:EVMQpsk:MARK10:X:POS?
Notes	If the specified marker is Fixed and a Marker Function is on, error -221 "Settings conflict; cannot adjust Fixed marker while Marker Function is on" is generated. The query returns the marker's absolute X Axis value in trace points if the control mode is Normal, or

	<p>the offset from the marker's reference marker in trace points if the control mode is Delta. The value is returned as a real number, not an integer, corresponding to the translation from X Axis Scale units to trace points (see "Fractional Trace Points", above). If the marker is Off the response is not a number.</p> <p>This command is not available when Marker Trace of the selected marker (:CALCulate:EVMQpsk:MARKer[1] 2 3 4 5 6 7 8 9 10 11 12:TRACe?) is set to POLar. In this case, this command is ignored.</p>
Preset	After a preset, all Markers are turned OFF, so Marker X Axis Value query returns a Not A Number (NAN).
State Saved	No
Min	-9.9E+37
Max	9.9E+37
Initial S/W Revision	Prior to A.02.00

Marker Y Axis Value (Query Only)

Returns the Marker Y Axis value, in the current marker Y Axis unit.

Mode	WCDMA, C2K, 1xEVDO
Remote Command	:CALCulate:EVMQpsk:MARKer[1] 2 ...12:Y?
Example	CALC:EVMQ:MARK11:Y?
Notes	The query returns the marker Y-axis result, if the control mode is Normal or Delta. If the marker is Off, the response is not a number.
Preset	Result dependant on markers setup and signal source
State Saved	No
Backwards Compatibility SCPI	:CALCulate:EVMQpsk:MARKer[1] 2 ...12:FUNCTion:RESult?
Initial S/W Revision	Prior to A.02.00

Marker Function

There is no Marker Function functionality supported in QPSK EVM. This front panel key displays a blank menu when pressed.

Key Path	Front-panel key
Initial S/W Revision	Prior to A.02.00

Marker To

There is no Marker To functionality supported in QPSK EVM. This front panel key displays a blank menu when pressed.

Key Path	Front-panel key
Initial S/W Revision	Prior to A.02.00

Meas

The information in this section is common to all measurements. For key and remote command information for a specific measurement, refer to the section that describes the measurement of interest.

Measurements available under the Meas key are specific to the current Mode.

When viewing Help for measurements, note the following:

NOTE

Operation for some keys differs between measurements. The information displayed in Help pertains to the current measurement. To see how a key operates in a different measurement, exit Help (press the Cancel Esc key), select the measurement, then reenter Help (press the Help key) and press that key.

Key Path	Front-panel key
Initial S/W Revision	Prior to A.02.00

Remote Measurement Functions

This section contains the following topics:

"Measurement Group of Commands" on page 2016

"Current Measurement Query (Remote Command Only)" on page 2018

"Limit Test Current Results (Remote Command Only)" on page 2018

"Data Query (Remote Command Only)" on page 2018

"Calculate/Compress Trace Data Query (Remote Command Only)" on page 2019

"Calculate Peaks of Trace Data (Remote Command Only)" on page 2024

"Hardware-Accelerated Fast Power Measurement (Remote Command Only)" on page 2025

"Format Data: Numeric Data (Remote Command Only)" on page 2039

"Format Data: Byte Order (Remote Command Only)" on page 2040

Initial S/W Revision	Prior to A.02.00
----------------------	------------------

Measurement Group of Commands

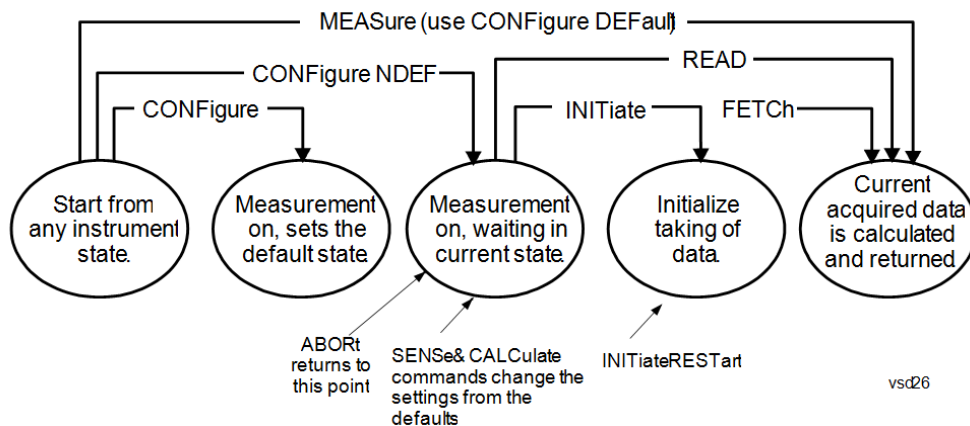

Measure Commands:

:MEASure:<measurement>[n]?

This is a fast single-command way to make a measurement using the factory default instrument settings. These are the settings and units that conform to the Mode Setup settings (e.g. radio standard) that you have currently selected.

- Stops the current measurement (if any) and sets up the instrument for the specified measurement using the factory defaults
- Initiates the data acquisition for the measurement
- Blocks other SCPI communication, waiting until the measurement is complete before returning results.
- If the function does averaging, it is turned on and the number of averages is set to 10.
- After the data is valid it returns the scalar results, or the trace data, for the specified measurement. The type of data returned may be defined by an [n] value that is sent with the command.
- The scalar measurement results will be returned if the optional [n] value is not included, or is set to 1. If the [n] value is set to a value other than 1, the selected trace data results will be returned. See each command for details of what types of scalar results or trace data results are available.
- ASCII is the default format for the data output. (Older versions of Spectrum Analysis and Phase Noise mode measurements only use ASCII.) The binary data formats should be used for handling large blocks of data since they are smaller and faster than the ASCII format. Refer to the FORMat:DATA command for more information.

If you need to change some of the measurement parameters from the factory default settings you can set up the measurement with the CONFigure command. Use the commands in the SENSE:<measurement> and CALCulate:<measurement> subsystems to change the settings. Then you can use the READ? command to initiate the measurement and query the results.

If you need to repeatedly make a given measurement with settings other than the factory defaults, you can use the commands in the SENSE:<measurement> and CALCulate:<measurement> subsystems to set up the measurement. Then use the READ? command to initiate the measurement and query results.

Measurement settings persist if you initiate a different measurement and then return to a previous one. Use READ:<measurement>? if you want to use those persistent settings. If you want to go back to the default settings, use MEASure:<measurement>?.

Configure Commands:

:CONFigure:<measurement>

This command stops the current measurement (if any) and sets up the instrument for the specified measurement using

the factory default instrument settings. It does not initiate the taking of measurement data unless INIT:CONTinuous is ON. If you change any measurement settings after using the CONFigure command, the READ command can be used to initiate a measurement without changing the settings back to their defaults.

In the Swept SA measurement in Spectrum Analyzer mode the CONFigure command also turns the averaging function on and sets the number of averages to 10 for all measurements.

:CONFigure: <measurement>: NDEFault stops the current measurement and changes to the specified measurement. It does not change the settings to the defaults. It does not initiate the taking of measurement data unless INIT:CONTinuous is ON.

The CONFigure? query returns the current measurement name.

The CONFigure:CATalog? query returns a quoted string of all licensed measurement names in the current mode. For example, "SAN, CHP, OBW, ACP, PST, TXP, SPUR, SEM, LIST".

Fetch Commands:

:FETCh:<measurement>[n]?

This command puts selected data from the most recent measurement into the output buffer. Use FETCh if you have already made a good measurement and you want to return several types of data (different [n] values, for example, both scalars and trace data) from a single measurement. FETCh saves you the time of re-making the measurement. You can only FETCh results from the measurement that is currently active, it will not change to a different measurement. An error message is reported if a measurement other than the current one is specified.

If you need to get new measurement data, use the READ command, which is equivalent to an INITiate followed by a FETCh.

The scalar measurement results will be returned if the optional [n] value is not included, or is set to 1. If the [n] value is set to a value other than 1, the selected trace data results will be returned. See each command for details of what types of scalar results or trace data results are available. The binary data formats should be used for handling large blocks of data since they are smaller and transfer faster than the ASCII format. (FORMat:DATA)

FETCh may be used to return results other than those specified with the original READ or MEASure command that you sent.

INITiate Commands:

:INITiate:<measurement>

This command is not available for measurements in all the instrument modes:

- Initiates a trigger cycle for the specified measurement, but does not output any data. You must then use the FETCh<meas> command to return data. If a measurement other than the current one is specified, the instrument will switch to that measurement and then initiate it.
- For example, suppose you have previously initiated the ACP measurement, but now you are running the channel power measurement. If you send INIT:ACP? it will change from channel power to ACP and will initiate an ACP measurement.
- Does not change any of the measurement settings. For example, if you have previously started the ACP measurement and you send INIT:ACP? it will initiate a new ACP measurement using the same instrument settings as the last time ACP was run.
- If your selected measurement is currently active (in the idle state) it triggers the measurement, assuming the trigger conditions are met. Then it completes one trigger cycle. Depending upon the measurement and the number of averages, there may be multiple data acquisitions, with multiple trigger events, for one full trigger cycle. It also holds off additional commands on GPIB until the acquisition is complete.

READ Commands:

:READ:<measurement>[n]?

- Does not preset the measurement to the factory default settings. For example, if you have previously initiated the ACP
-

measurement and you send READ:ACP? it will initiate a new measurement using the same instrument settings.

- Initiates the measurement and puts valid data into the output buffer. If a measurement other than the current one is specified, the instrument will switch to that measurement before it initiates the measurement and returns results.
 - For example, suppose you have previously initiated the ACP measurement, but now you are running the channel power measurement. Then you send READ:ACP? It will change from channel power back to ACP and, using the previous ACP settings, will initiate the measurement and return results.
 - Blocks other SCPI communication, waiting until the measurement is complete before returning the results
 - If the optional [n] value is not included, or is set to 1, the scalar measurement results will be returned. If the [n] value is set to a value other than 1, the selected trace data results will be returned. See each command for details of what types of scalar results or trace data results are available. The binary data formats should be used when handling large blocks of data since they are smaller and faster than the ASCII format. (FORMat:DATA)
-

Initial S/W Revision	Prior to A.02.00
----------------------	------------------

Current Measurement Query (Remote Command Only)

This command returns the name of the measurement that is currently running.

Remote Command	:CONFigure?
-----------------------	-------------

Example	CONF?
----------------	-------

Initial S/W Revision	Prior to A.02.00
----------------------	------------------

Limit Test Current Results (Remote Command Only)

Queries the status of the current measurement limit testing. It returns a 0 if the measured results pass when compared with the current limits. It returns a 1 if the measured results fail any limit tests.

Remote Command	:CALCulate:CLIMits:FAIL?
-----------------------	--------------------------

Example	CALC:CLIM:FAIL? queries the current measurement to see if it fails the defined limits. Returns a 0 or 1: 0 it passes, 1 it fails.
----------------	--

Initial S/W Revision	Prior to A.02.00
----------------------	------------------

Data Query (Remote Command Only)

Returns the designated measurement data for the currently selected measurement and subopcode.

n = any valid subopcode for the current measurement. See the measurement command results table for your current measurement, for information about what data is returned for the subopcodes.

This command uses the data setting specified by the FORMat:BORDER and FORMat:DATA commands and can return real or ASCII data. (See the format command descriptions under Input/Output in the Analyzer Setup section.)

Remote Command	:CALCulate:DATA[n]?
Notes	The return trace depends on the measurement. In CALCulate:<meas>:DATA[n], n is any valid subopcode for the current measurement. It returns the same data as the FETCH:<measurement>? query where <measurement> is the current measurement.
Initial S/W Revision	Prior to A.02.00

Calculate/Compress Trace Data Query (Remote Command Only)

Returns compressed data for the currently selected measurement and sub-opcode [n].

n = any valid sub-opcode for that measurement. See the MEASure:<measurement>? command description of your specific measurement for information on the data that can be returned.

The data is returned in the current Y Axis Unit of the analyzer. The command is used with a sub-opcode <n> (default=1) to specify the trace. With trace queries, it is best if the analyzer is not sweeping during the query. Therefore, it is generally advisable to be in Single Sweep, or Update=Off.

This command is used to compress or decimate a long trace to extract and return only the desired data. A typical example would be to acquire N frames of GSM data and return the mean power of the first burst in each frame. The command can also be used to identify the best curve fit for the data.

Remote Command	:CALCulate:DATA<n>:COMPRESS? BLOCK CFIT MAXimum MINimum MEAN DMEan RMS RMSCubed SAMPLE SDEVIation PPHase [,<soffset> [,<length>[,<roffset>[,<rlimit>]]]]
Example	To query the mean power of a set of GSM bursts: Supply a signal that is a set of GSM bursts. Select the IQ Waveform measurement (in IQ Analyzer Mode). Set the sweep time to acquire at least one burst. Set the triggers such that acquisition happens at a known position relative to a burst. Then query the mean burst levels using, CALC:DATA2:COMP? MEAN, 24e-6, 526e-6 (These parameter values correspond to GSM signals, where 526e-6 is the length of the burst in the slot and you just want 1 burst.)
Notes	The command supports 5 parameters. Note that the last 4 (<soffset>, <length>, <roffset>, <rlimit>) are optional. But these optional parameters must be entered in the specified order. For example, if you want to specify <length>, then you must also specify <soffset>. See details below for a definition of each of these parameters. This command uses the data in the format specified by FORMat:DATA, returning either binary or ASCII data.
Initial S/W Revision	Prior to A.02.00

- BLOCK or block data - returns all the data points from the region of the trace data that you specify. For example, it could be used to return the data points of an input signal over several timeslots, excluding the portions of the trace data that you do not want. (This is x,y pairs for trace data and I,Q pairs for complex data.)

- CFIT or curve fit - applies curve fitting routines to the data. <soffset> and <length> are required to define the data that you want. <roffset> is an optional parameter for the desired order of the curve equation. The query will return the following values: the x-offset (in seconds) and the curve coefficients ((order + 1) values).

MIN, MAX, MEAN, DME, RMS, RMSC, SAMP, SDEV and PPH return one data value for each specified region (or <length>) of trace data, for as many regions as possible until you run out of trace data (using <roffset> to specify regions). Or they return the number of regions you specify (using <rlimit>) ignoring any data beyond that.

- MINimum - returns the minimum data point (y value) for the specified region(s) of trace data. For I/Q trace data, the minimum magnitude of the I/Q pairs is returned.
- MAXimum - returns the maximum data point (y value) for the specified region(s) of trace data. For I/Q trace data, the maximum magnitude of the I/Q pairs is returned.
- MEAN - returns a single value that is the arithmetic mean of the data point values (in dB/ dBm) for the specified region(s) of trace data. For I/Q trace data, the mean of the magnitudes of the I/Q pairs is returned. See the following equations.

-

NOTE

If the original trace data is in dB, this function returns the arithmetic mean of those log values, not log of the mean power which is a more useful value. The mean of the log is the better measurement technique when measuring CW signals in the presence of noise. The mean of the power, expressed in dB, is useful in power measurements such as Channel Power. To achieve the mean of the power, use the RMS option.

Equation 1

Mean Value of Data Points for Specified Region(s)

$$MEAN = \frac{1}{n} \sum_{X_i \in \text{region}(s)} X_i$$

where X_i is a data point value, and n is the number of data points in the specified region(s).

Equation 2

Mean Value of I/Q Data Pairs for Specified Region(s)

$$MEAN = \frac{1}{n} \sum_{X_i \in \text{region}(s)} |X_i|$$

where $|X_i|$ is the magnitude of an I/Q pair, and n is the number of I/Q pairs in the specified region(s).

- DMEan - returns a single value that is the mean power (in dB/ dBm) of the data point values for the specified region(s) of trace data. See the following equation:

Equation 3

DMEan Value of Data Points for Specified Region(s)

$$\text{DME} = 10 \times \log_{10} \left(\frac{1}{n} \sum_{X_i \in \text{region}(s)} 10^{\frac{X_i}{10}} \right)$$

- RMS - returns a single value that is the average power on a root-mean-squared voltage scale (arithmetic rms) of the data point values for the specified region(s) of trace data. See the following equation.

NOTE For I/Q trace data, the rms of the magnitudes of the I/Q pairs is returned. See the following equation. This function is very useful for I/Q trace data. However, if the original trace data is in dB, this function returns the rms of the log values which is not usually needed.

Equation 4

RMS Value of Data Points for Specified Region(s)

$$\text{RMS} = \sqrt{\frac{1}{n} \sum_{X_i \in \text{region}(s)} X_i^2}$$

where X_i is a data point value, and n is the number of data points in the specified region(s).

Equation 5

RMS Value of I/Q Data Pairs for Specified Region(s)

$$\text{RMS} = \sqrt{\frac{1}{n} \sum_{X_i \in \text{region}(s)} X_i X_i^*}$$

where X_i is the complex value representation of an I/Q pair, X_i^* its conjugate complex number, and n is the number of I/Q pairs in the specified region(s).

Once you have the rms value for a region of trace data (linear or I/Q), you may want to calculate the mean power. You must convert this rms value (peak volts) to power in dBm:

$$10 \times \log[10 \times (\text{rms value})^2]$$

- SAMPlE - returns the first data value (x,y pair) for the specified region(s) of trace data. For I/Q trace data, the first I/Q pair is returned.
- SDEVIation - returns a single value that is the arithmetic standard deviation for the data point values for the specified region(s) of trace data. See the following equation.
- For I/Q trace data, the standard deviation of the magnitudes of the I/Q pairs is returned. See the following equation.

Equation 6

Standard Deviation of Data Point Values for Specified Region(s)

$$\text{SDEV} = \sqrt{\frac{1}{n} \sum_{X_i \in \text{region}(s)} (X_i - \bar{X})^2}$$

where X_i is a data point value, \bar{X} is the arithmetic mean of the data point values for the specified region (s), and n is the number of data points in the specified region(s).

$$\text{SDEV} = \sqrt{\frac{1}{n} \sum_{X_i \in \text{region}(s)} (|X_i| - \bar{X})^2}$$

where $|X_i|$ is the magnitude of an I/Q pair, \bar{X} is the mean of the magnitudes for the specified region(s), and n is the number of data points in the specified region(s).

- PPHase - returns the x,y pairs of both rms power (dBm) and arithmetic mean phase (radian) for every specified region and frequency offset (Hz). The number of pairs is defined by the specified number of regions. This parameter can be used for I/Q vector ($n=0$) in Waveform (time domain) measurement and all parameters are specified by data point in PPHase.

The rms power of the specified region may be expressed as:

$$\text{Power} = 10 \times \log [10 \times (\text{RMS I/Q value})] + 10.$$

The RMS I/Q value (peak volts) is:

$$\sqrt{\frac{1}{n} \sum_{X_i \in \text{region}} X_i X_i^*}$$

where X_i is the complex value representation of an I/Q pair, X_i^* its conjugate complex number, and n is the number of I/Q pairs in the specified region.

The arithmetic mean phase of the specified region may be expressed as:

$$\frac{1}{n} \sum_{Y_i \in \text{region}} Y_i$$

where Y_i is the unwrapped phase of I/Q pair with applying frequency correction and n is the number of I/Q pairs in the specified region.

The frequency correction is made by the frequency offset calculated by the arithmetic mean of every specified region's frequency offset. Each frequency offset is calculated by the least square method against the unwrapped phase of I/Q pair.

Sample Trace Data - Constant Envelope

(See below for explanation of variables.)

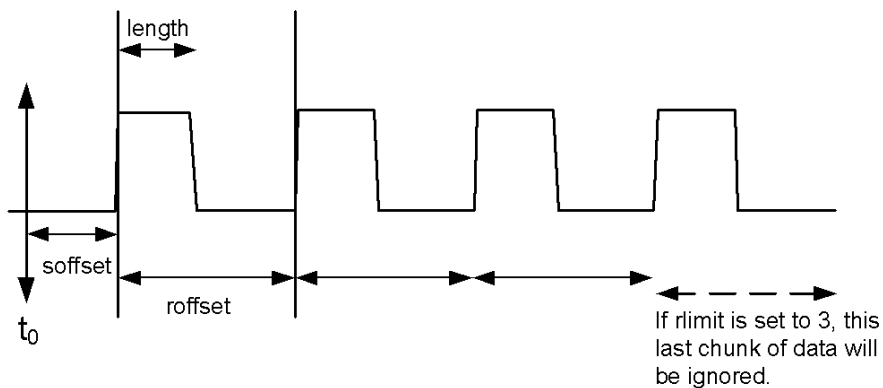

Sample Trace Data - Not Constant Envelope

(See below for explanation of variables.)

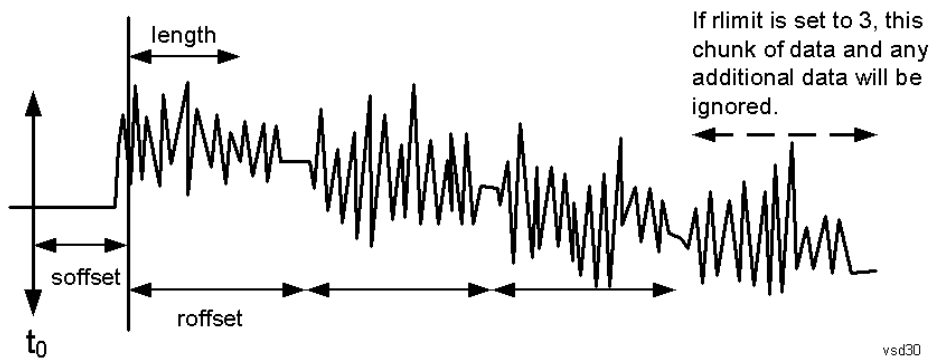

$\langle \text{soffset} \rangle$ - start offset is an optional real number. (It is in seconds for time-domain traces, and is a dimensionless index 0 to $N_{\text{points}} - 1$, for frequency-domain traces). It specifies the amount of data at the beginning of the trace that will be ignored before the decimation process starts. It is the time or frequency change from the start of the trace to the point where you want to start using the data. The default value is zero.

$\langle \text{length} \rangle$ - is an optional real number. (It is in seconds for time-domain traces, and is a dimensionless index 0 to $N_{\text{points}} - 1$, for frequency-domain traces). It defines how much data will be compressed into one value. This parameter has a default value equal to the current trace length.

$\langle \text{roffset} \rangle$ - repeat offset is an optional real number. (It is in seconds for time-domain traces, and is a dimensionless index 0 to $N_{\text{points}} - 1$, for frequency-domain traces). It defines the beginning of the next field of trace elements to be compressed. This is relative to the beginning of the previous field. This parameter has a default value equal to the $\langle \text{length} \rangle$ variable. Note that this parameter is used for a completely different purpose when curve fitting (see CFIT above).

$\langle \text{rlimit} \rangle$ - repeat limit is an optional integer. It specifies the number of data items that you want returned. It will ignore any additional items beyond that number. You can use the Start offset and the Repeat limit to pick out exactly what part of the data you want to use. The default value is all the data.

Calculate Peaks of Trace Data (Remote Command Only)

Returns a list of all the peaks for the currently selected measurement and sub-opcode [n]. The peaks must meet the requirements of the peak threshold and excursion values.

n = any valid sub-opcode for the current measurement. See the MEASure:<measurement> command description of your specific measurement for information on the data that can be returned.

The command can only be used with specific sub-opcodes with measurement results that are trace data. Both real and complex traces can be searched, but complex traces are converted to magnitude in dBm. In many measurements the sub-opcode n=0, is the raw trace data which cannot be searched for peaks. And Sub-opcode n=1, is often calculated results values which also cannot be searched for peaks.

This command uses the data setting specified by the FORMat:BORDER and FORMat:DATA commands and can return real or ASCII data. If the format is set to INT,32, it returns REAL,32 data.

The command has four types of parameters:

- Threshold (in dBm)
- Excursion (in dB)
- Sorting order (amplitude, frequency, time)
- Optional in some measurements: Display line use (all, > display line, < display line)

Remote Command	<p>For Swept SA measurement:</p> <pre>:CALCulate:DATA[1] 2 ... 6:PEAKs? <threshold>,<excursion>[,AMPLitude FREQuency TIME[,ALL GTDLine LTDLine]]</pre> <p>For most other measurements:</p> <pre>:CALCulate:DATA[1] 2 ... 6:PEAKs? <threshold>,<excursion>[,AMPLitude FREQuency TIME]</pre>
-----------------------	--

Example	<p>Example for Swept SA measurement in Spectrum Analyzer Mode:</p> <p>CALC:DATA4:PEAK? -40, 10, FREQ, GTDL This will identify the peaks of trace 4 that are above -40 dBm, with excursions of at least 10 dB. The peaks are returned in order of increasing frequency, starting with the lowest frequency. Only the peaks that are above the display line are returned.</p> <p>Query Results 1:</p> <p>With FORMat:DATA REAL, 32 selected, it returns a list of floating-point numbers. The first value in the list is the number of peak points that are in the following list. A peak point consists of two values: a peak amplitude followed by its corresponding frequency (or time).</p> <p>If no peaks are found the peak list will consist of only the number of peaks, (0).</p>
----------------	---

Notes	<p><n> - is the trace that will be used</p> <p><threshold> - is the level below which trace data peaks are ignored. Note that the threshold value is required and is always used as a peak criterion. To effectively disable the threshold criterion for this command, provide a substantially low threshold value such as -200 dBm. Also note that the threshold value used in this command is independent of and has no effect on the threshold value stored under the Peak Criteria menu.</p> <p><excursion> - is the minimum amplitude variation (rise and fall) required for a signal to be identified as peak. Note that the excursion value is required and is always used as a peak criterion. To effectively disable the excursion criterion for this command, provide the minimum value of 0.0 dB. Also note that the excursion value used in this command is independent of and has no effect on the</p>
--------------	---

excursion value stored under the Peak Criteria menu.

Values must be provided for threshold and excursion. The sorting and display line parameters are optional (defaults are AMPLitude and ALL).

Note that there is always a Y-axis value for the display line, regardless of whether the display line state is on or off. It is the current Y-axis value of the display line which is used by this command to determine whether a peak should be reported. Sorting order:

AMPLitude - lists the peaks in order of descending amplitude, with the highest peak first (default if optional parameter not sent)

FREQUency - lists the peaks in order of occurrence, left to right across the x-axis.

TIME - lists the peaks in order of occurrence, left to right across the x-axis.

Peaks vs. Display Line:

ALL - lists all of the peaks found (default if optional parameter not sent).

GTDLine (greater than display line) - lists all of the peaks found above the display line.

LTDLine (less than display line) - lists all of the peaks found below the display line.

Initial S/W Revision	Prior to A.02.00
----------------------	------------------

Hardware-Accelerated Fast Power Measurement (Remote Command Only)

The Fast Power option (FP2) enables very fast channel power measurements for instruments with the prerequisite hardware (DP2 and/or B40). It accomplishes this by performing real-time overlapped FFTs at the hardware layer, using software for basic post-processing before returning the result to the user. The upshot of this approach is improved throughput for user applications that require many sequential power measurements.

The analysis bandwidth of FP2 is limited by the licenses in the instrument, but its maximum overall analysis bandwidth per acquisition is 40 MHz.

FP2 is remote-only, which means the instrument does not switch to any particular mode or measurement. FP2 commands can be sent while another application is in use on the front panel.

Each Fast Power measurement can be predefined using an array index, and up to 1,000 measurements can be stored. In the following documentation, instances of [1,2,...,999] can be substituted with a particular measurement index, e.g. CALC:FPOW:POW1?, CALC:FPOW:POW2?, CALC:FPOW:POW134?. In this way, power measurements can be defined one time in a batch, and then executed multiple times without having to redefine them, similar to “list mode” on other measurements.

In addition to basic channel power measurements, there are a number of other measurement “functions” for each channel, including peak power, peak frequency, and power spectral density. See the Function parameter for more information.

Reset Fast Power Measurement (Remote Command Only)

Resets the measurement configuration to the defaults.

Mode	All
Remote Command	:CALCulate:FPOWer:POWer[1,2,...,999]:RESet
Example	:CALC:FPOW:POW1:RES

Notes	Option FP2 is required.
Initial S/W Revision	A.14.00

Define Fast Power Measurement (Remote Command Only)

Fast Power acquisitions are configured using the DEFine command. This command accepts a comma-delimited string of configuration parameters and their appropriate values, which are all specified in the subsection below.

Mode	All
Remote Command	:CALCulate:FPOWER:POWer[1,2,...,999]:DEFine "configuration string"
Example	:CALC:FPOW:POW1:DEF "CenterFrequency=2e9, AcquisitionTime=0.005"
Notes	See below for a list of measurement variables that can be defined in the configuration string.
Initial S/W Revision	A.14.00

Acquisition Time

Example	CALC:FPOW:POW1:DEF "AcquisitionTime=0.002"
Notes	The acquisition time parameter sets the time in which the entire spectrum is measured. An increase in the acquisition time yields an improvement in measurement repeatability.
Preset	0.001 s
Range	0 s to 1 s
Default Unit	Time (s)
Initial S/W Revision	A.14.00

Center Frequency

Example	CALC:FPOW:POW1:DEF "CenterFrequency=2e9"
Notes	The center frequency parameter sets the frequency in which the measurement is centered around. The OffsetFrequency parameter is calculated relative to the center frequency.
Preset	1 GHz
Range	0 Hz to maximum instrument frequency
Default Unit	Frequency (Hz)
Initial S/W Revision	A.14.00

DC Coupled

Example	CALC:FPOW:POW1:DEF "DCCoupled=True"
Notes	The DC coupled parameter allows the user to specify whether the DC blocking capacitor is utilized. Set parameter to true when measuring frequencies below 10 MHz.
Preset	False
Range	True (DC Coupled) or False (AC Coupled)
Default Unit	Boolean
Initial S/W Revision	A.14.00

DetectorType

Example	CALC:FPOW:POW1:DEF "DetectorType=Peak"
Notes	Option FP2 is required. The detector type parameter allows the user to choose whether a RMS average or peak value is used during the measurement.
Preset	RmsAverage
Range	RmsAverage, Peak
Initial S/W Revision	A.14.00

Do Noise Correction

Example	CALC:FPOW:POW1:DEF "DoNoiseCorrection=True"
Notes	When noise correction is enabled, the linear noise power contributed by the analyzer is subtracted from all measurements. This effectively lowers the noise floor of the analyzer. When noise correction is enabled, the first measurement for a given set of input parameters will take extra time. This is because the analyzer takes an extra acquisition with the RF input disconnected from the analyzer's front end to measure the noise of just the analyzer. The measured noise floor is stored in a cache so the noise acquisition will occur only once for the same state settings. In other words, if noise correction was turned on and the analyzer made an acquisition at frequency A, then frequency B, and back again to frequency A, the hidden initial noise floor acquisition would only occur for the first acquisition at frequency A and the cached noise floor would be used the second time frequency A was measured.
Preset	False
Range	True (enable noise correction) or False (disable noise correction)
Default Unit	Boolean
Initial S/W Revision	A.14.00

Do Spur Suppression

Example	CALC:FPOW:POW1:DEF "DoSpurSuppression=True"
Notes	<p>When measuring very low level signals, or when large out-of-band inputs are input into the analyzer, sometimes unwanted spurs and residuals can appear in the measured spectrum. Spur suppression is a method to help minimize the levels of these internally generated spurs and residuals.</p> <p>When spur suppression is enabled, the analyzer will automatically take two acquisitions using two different internal analog LO frequencies. The FFT spectrums from both acquisitions are combined by taking the minimum power between both traces on a per FFT bin basis. External signals will have the same amplitude for both traces and therefore will return the expected amplitudes. However, low level spurs and residuals generated internally to the analyzer tend to move to different FFT bins depending on the internal analog LO frequency used, and therefore tend to be suppressed using this spur suppression method.</p> <p>Because two acquisitions, rather than a single acquisition, are made when spur suppression is enabled, the measurement time will always be slower when spur suppression is enabled.</p>
Preset	False
Range	True (enable spur suppression) or False (disable spur suppression)
Default Unit	Boolean
Initial S/W Revision	A.14.00

Electronic Attenuator Bypass

Example	CALC:FPOW:POW1:DEF "ElecAttBypass =False"
Notes	The electronic attenuation bypass parameter allows the user to either utilize or bypass the electronic attenuator. The electronic attenuator is only available for frequencies up to 3.6 GHz. Set parameter to true when using frequencies above 3.6 GHz and set the parameter to false when using the preamp.
Preset	True
Range	True (bypass electronic attenuator) or False (use electronic attenuator)
Default Unit	Boolean
Initial S/W Revision	A.14.00

Electronic Attenuation

Example	CALC:FPOW:POW1:DEF "ElecAttenuation=10"
Notes	<p>Option EA3 is required.</p> <p>The electronic attenuation value parameter sets the amount of electrical attenuation from 0 to 24 dB (1 dB steps).</p> <p>Set "ElecAttBypass=False" to make sure the electronic attenuator path is enabled.</p>
Preset	0 dB
Range	0 – 24 dB (1 dB steps)

Default Unit	dB
Initial S/W Revision	A.14.00

IF Gain

Example	CALC:FPOW:POW1:DEF "IFGain=10"
Notes	The IF gain parameter allows the user to specify the gain at the IF stage anywhere from -6 to 16 dB (1 dB steps). This is an advanced feature, and for most cases this should remain at its default value of 0 dB.
Preset	0 dB
Range	-6 - 16 dB (1 dB steps)
Default Unit	dB
Initial S/W Revision	A.14.00

IF Type

Example	CALC:FPOW:POW1:DEF "IFType=B25M"
Notes	The IF type parameter allows the user to select between different IF paths. For example, if the signal is less than 25 MHz wide, then the user can select the B25M path to take advantage of additional filtering on this analog IF path.
Preset	B40M
Range	B10M, B25M, B40M
Initial S/W Revision	A.14.00

Include Power Spectrum

Example	CALC:FPOW:POW1:DEF "IncludePowerSpectrum=True"
Notes	The power spectrum parameter allows the user to read data on the entire spectrum for diagnostic purposes. It is not recommended for production use. See CALC:FPOW:POW[n]:READ2? for details on the binary format of the response.
Preset	False
Range	True (return both channel power and full power spectrum) or False (returns only channel power)
Default Unit	Boolean
Initial S/W Revision	A.14.00

Mechanical Attenuation

Example	CALC:FPOW:POW1:DEF "MechAttenuation=10"
Notes	The mechanical attenuation value parameter sets the amount of mechanical attenuation anywhere from 0 to 70 dB (2 dB steps).
Preset	0 dB
Range	0 – 70 dB (2 dB steps)
Default Unit	dB
Initial S/W Revision	A.14.00

Preamp Mode

Example	CALC:FPOW:POW1:DEF "PreAmpMode=Low"
Notes	The license for the appropriate preamp is required. The preamp mode parameter specifies whether the preamps are being utilized. Low allows any preamps up to 3.6 GHz, and Full allows all licensed preamps. Set "ElecAttBypass=True" in order to utilize any preamps.
Preset	Off
Range	Off, Low, Full
Initial S/W Revision	A.14.00

Resolution Bandwidth Mode

Example	CALC:FPOW:POW1:DEF "PreAmpMode=Low"
Notes	The resolution bandwidth mode parameter allows the user to choose whether the RBW filter is automatically or manually set. The BestSpeed value minimizes measurement time, while the Narrowest value minimizes RBW size (minimum of two FFT bins per RBW). To manually specify an RBW, set this parameter to Explicit, and set the ResolutionBW parameter to the desired value.
Preset	BestSpeed
Range	BestSpeed, Narrowest, Explicit
Initial S/W Revision	A.14.00

Resolution Bandwidth

Example	CALC:FPOW:POW1:DEF "ResolutionBW=25e3"
Notes	The resolution bandwidth parameter sets the 3-dB bandwidth of the RBW filter. The ResolutionBWMode parameter must be set to Explicit in order to manually set the RBW.

Preset	0 Hz
Default Unit	Hz
Initial S/W Revision	A.14.00

Trigger Delay

Example	CALC:FPOW:POW1:DEF "TriggerDelay=0.025"
Notes	The trigger delay parameter sets the time after an external trigger is detected until the measurement is performed.
Preset	0 s
Range	0 – 1 s
Default Unit	Seconds
Initial S/W Revision	A.14.00

Trigger Level

Example	CALC:FPOW:POW1:DEF "TriggerLevel=2"
Notes	The trigger level parameter sets the voltage value at which an external trigger is detected.
Preset	1.2 V
Range	-5 to 5 V
Default Unit	Volts
Initial S/W Revision	A.14.00

Trigger Slope

Example	CALC:FPOW:POW1:DEF "TriggerSlope=Negative"
Notes	The trigger slope parameter indicates the direction of the edge trigger voltage for detection.
Preset	Positive
Range	Positive, Negative
Initial S/W Revision	A.14.00

Trigger Source

Example	CALC:FPOW:POW1:DEF "TriggerSource=Ext1"
Notes	The trigger source parameter allows the user to choose between measurement's triggering freely or controlled by an external input. Ext1 and Ext2 correspond to Trigger 1 In and Trigger 2 In, respectively.
Preset	Free
Range	Free, Ext1, Ext2
Initial S/W Revision	A.14.00

Trigger Timeout

Example	CALC:FPOW:POW1:DEF "TriggerTimeout=0.1"
Notes	The trigger timeout parameter sets the time in which the analyzer will wait for a trigger before automatically performing the measurement.
Preset	1 s
Range	0 - 1 s
Default Unit	Seconds
Initial S/W Revision	A.14.00

Signal Input

Example	CALC:FPOW:POW1:DEF "SignalInput=Fp50MHzCW"
Notes	The signal input parameter allows the user to select between using the main RF input or the internal analyzer reference CW signal of 50 MHz.
Preset	FpMainRf
Range	FpMainRf, Fp50MHzCW
Initial S/W Revision	A.14.00

Use Preselector

Example	CALC:FPOW:POW1:DEF "UsePreSelector=True"
Notes	The preselector parameter allows the user to either utilize or bypass the front end tunable filter at frequencies above 3.6 GHz. For frequencies below 3.6 GHz, the preselector is automatically bypassed, so you do not need to set this parameter to False in those cases.
Preset	False
Range	True (use preselector above 3.6 GHz), or False (preselector bypassed)

Default Unit	Boolean
Initial S/W Revision	A.14.00

Channel Bandwidth Array

Example	CALC:FPOW:POW1:DEF "Bandwidth=[3.84e6, 5e6, 3.84e6]"
Notes	The bandwidth parameter array defines the bandwidth of each channel that will be measured. All array parameters should have the same number of elements. Alternatively, if all the elements are the same value, a single number with no square brackets can be used to define the parameter.
Preset	[1 e6]
Range	0 to 40 MHz
Default Unit	Hz
Initial S/W Revision	A.14.00

Channel Filter Type Array

Example	CALC:FPOW:POW1:DEF "FilterType=[RRC, IBW, RRC]"
Notes	The filter type parameter allows the user to choose between an integration bandwidth (IBW) filter or a root-raised-cosine (RRC) filter. The integration bandwidth filter weighs all frequencies within the bandwidth equally. The root-raised-cosine filter has an associated shape parameter, defined by the FilterAlpha parameter. All array parameters should have the same number of elements. Alternatively, if all the elements are the same value, a single value with no square brackets can be used to define the parameter.
Preset	[IBW]
Range	IBW, RRC
Initial S/W Revision	A.14.00

Channel Filter Alpha Array

Example	CALC:FPOW:POW1:DEF "FilterAlpha=[0.5, 0.0, 0.5]"
Notes	The filter alpha parameter allows the user to adjust the alpha value associated with the root-raised-cosine (RRC) filter type. Set FilterType to RRC in order to utilize this parameter. All array parameters should have the same number of elements. Alternatively, if all the elements are the same value, a single number with no square brackets can be used to define the parameter.
Preset	[0.22]
Range	0.0 - 1.0

Initial S/W Revision	A.14.00
-------------------------	---------

Channel Measurement Function Array

Example	CALC:FPOW:POW1:DEF "Function=[BandPower, PeakPower, BandPower]"
Notes	<p>This parameter array defines what measurement is being made for each individually-specified channel:</p> <p>BandPower: Total power within the specified bandwidth of the channel (dBm)</p> <p>BandDensity: Total power density within the specified bandwidth of the channel (dBm/Hz)</p> <p>PeakPower: The peak power value within the specified bandwidth of the channel (dBm)</p> <p>PeakFrequency: The frequency which corresponds to the peak power value within the specified bandwidth of the channel. This frequency is relative to the center frequency (Hz)</p> <p>XdBBandwidth: The half power (-3.01 dB) bandwidth of the highest amplitude signal that resides within the channel (Hz), dB is configurable using XdBBandwidth parameter</p> <p>OccupiedBandwidth: The bandwidth at which 99% of the total power resides within the channel (Hz), percentage configurable using OccupiedBandwidthPercent parameter</p> <p>All array parameters should have the same number of elements. Alternatively, if all the elements are the same value, a single value with no square brackets can be used to define the parameter.</p>
Preset	[BandPower]
Range	BandPower, BandDensity, PeakPower, PeakFrequency, XdBBandwidth, OccupiedBandwidth
Initial S/W Revision	A.14.00

Channel Offset Frequency Array

Example	CALC:FPOW:POW1:DEF "OffsetFrequency=[-5e6, 0, 5e6]"
Notes	<p>The offset frequency parameter array defines the difference between the center frequency to the center frequency of each channel.</p> <p>All array parameters should have the same number of elements.</p>
Preset	[0]
Range	0 to 20 MHz
Default Unit	Hz
Initial S/W Revision	A.14.00

Channel Occupied Bandwidth Percent Array

Example	CALC:FPOW:POW1:DEF "OccupiedBandwidthPercent =[0.95, 0.95, 0.95]"
Notes	This parameter only applies for channels whose Function is set to OccupiedBandwidth. The occupied

bandwidth percent parameter specifies the percent of total power in these channels. The valid range for this parameter is 0.0 to 1.0, where 1.0 represents 100%. The default for this parameter is 0.99, which will return the bandwidth that contains 99% of the total channel power.

Preset	[0.99]
Range	0 – 1.0
Initial S/W Revision	A.14.00

Channel x-dB Bandwidth Array

Example	CALC:FPOW:POW1:DEF " XdBBandwidth =[-6.02, -3.01, -1.0]"
Notes	This parameter only applies for channels whose Function is set to XdBBandwidth. The X dB bandwidth parameter is used to specify the power relative to the peak channel power over which the bandwidth is calculated. The parameter value must be a negative number.
Preset	[-3.01]
Range	-200 to 0 dB
Default Unit	dB
Initial S/W Revision	A.14.00

Define Fast Power Measurement Query (Remote Command Only)

The DEFine? command is used to retrieve a list of all defined parameters in an ASCII string format

```

M All
o
d
e
R :CALCulate:FPOWER:POWer [1,2,...,999]:DEFine?
e
m
o
t
e
C
o
m
m
a
n
d
E :CALC:FPOW:POW1:DEF?

```

```
x
a
m
p
l
e
-----
N This command query is used to retrieve a list of all defined parameters in an ASCII format.
o The following is an example of the returned results:
t "DCCoupled=False,ElecAttBypass=True,ElecAttenuation=0,IFGain=0,MechAttenuation=0,PreAmpMode=Off,PreSelectorOffset
e =0,UsePreSelector=False,ExternalReferenceFrequency=10000000,FrequencyReferenceSource=AutoExternalFrequencyRefer
s ence,IFType=B40M,LOMode=SLW,SignalInput=FpMainRf,AcquisitionTime=0.001,CenterFrequency=1000000000,Resolution
BW=0,ResolutionBWMode=BestSpeed,DetectorType=RmsAverage,Bandwidth=[1000000],OffsetFrequency=[0],Function=
[BandPower],FilterType=[IBW],FilterAlpha=[0.22],OccupiedBandwidthPercent=[0.99],XdBBandwidth=[-
3.01],DoNoiseCorrection=False,DoSpurSuppression=False,MeasurementMethod=HardwareFFT,IncludePowerSpectrum=False,
e,TriggerDelay=0,TriggerLevel=1.2,TriggerSlope=Positive,TriggerSource=Free,TriggerTimeout=1"
-----
I A.14.00
n
i
t
i
a
l

S
/
W

R
e
v
i
s
i
o
n
```

Configure Fast Power Measurement (Remote Command Only)

The configure command begins hardware setup and returns immediately, with no acquisition made. This can be used in parallel with other hardware operations to effectively hide the hardware setup time.

Mode	All
Remote Command	:CALCulate:FPOWer:POWer[1,2,...,999]:CONFigure
Example	:CALC:FPOW:POW1:CONF
Notes	Option FP2 is required.
Initial S/W Revision	A.14.00

Initiate Fast Power Measurement (Remote Command Only)

The INITiate command begins an acquisition and returns immediately. The results of the measurement can be retrieved using FETCh.

Mode	All
Remote Command	:CALCulate:FPOWer:POWer[1,2,...,999]:INITiate
Example	:CALC:FPOW:POW1:INIT
Notes	Option FP2 is required.
Initial S/W Revision	A.14.00

Fetch Fast Power Measurement (Remote Command Only)

The FETCh command query is used to retrieve the results of an acquisition initiated by the INIT command. The returned results are in ASCII string format. The string begins and ends with quotation marks.

Mode	All
Remote Command	:CALCulate:FPOWer:POWer[1,2,...,999]:FETCh?
Example	:CALC:FPOW:POW1:FETC?
Notes	Option FP2 is required. Returns m comma-separated ASCII values, where m corresponds to the number of bandwidths defined. 1. Declared function return in the 1st specified channel 2. Declared function return in the 2nd specified channel ... m. Declared function return in the last specified channel The INIT and FETC? command sequence performs the same functionality of a single CALC:FPOW:POW[n]? query. Units of the returned values are dependent on the Function parameter for each channel.
Initial S/W Revision	A.14.00

Execute Fast Power Measurement (Remote Command Only)

This command query is used as shorthand for an INIT command immediately followed by a FETC? command. The returned results are in ASCII string format. The string begins and ends with quotation marks.

Mode	All
Remote Command	:CALCulate:FPOWer:POWer[1,2,...,999]?
Example	:CALC:FPOW:POW1?

Notes	Option FP2 is required. See notes for Fast Power Fetch for return format.
Initial S/W Revision	A.14.00

Binary Read Fast Power Measurement (Remote Command Only)

This command query is used as shorthand for an INIT command immediately followed by a FETC? command. The returned results are in a binary format.

Mode	All
Remote Command	:CALCulate:FPOWER:POWER[1,2,...,999]:READ? :CALCulate:FPOWER:POWER[1,2,...,999]:READ1?
Example	:CALC:FPOW:POW1:READ? :CALC:FPOW:POW1:READ1?
Notes	Option FP2 is required. Returns m 4 byte floating point binary values (Little-Endian), where m corresponds to the number of bandwidths defined.
Initial S/W Revision	A.14.00

Diagnostic Binary Read Fast Power Measurement (Remote Command Only)

This command query is used as shorthand for an INIT command immediately followed by a FETC? command. The returned results are in a binary format. This command is used primarily for diagnostic purposes to test for ADC overloads and to visibly inspect the spectrum.

Mode	All
Remote Command	:CALCulate:FPOWER:POWER[1,2,...,999]:READ2?
Example	:CALC:FPOW:POW1:READ2?
Notes	Option FP2 is required. Note: Spectrum data is only returned if the IncludePowerSpectrum parameter is set to True. If IncludePowerSpectrum is False, the number of spectrum points will be zero (0). Units of the returned values are dependent on the Function parameter per channel (e.g. dBm for BandPower, Hz for PeakFrequency). Returns binary data (Little-Endian) that contains information on m amount of channels, along with ADC over range and full spectrum data. The following is the binary format of the response. Bandwidth Return Value 1. Number of channels specified, m [4 byte int] 2. Declared function result for the 1st specified channel [4 byte float]

-
- 3. Declared function result for the 2nd specified channel [4 byte float]
 - ...
 - (m + 1). Declared function result for the last (mth) specified channel [4 byte float]
- ADC Over Range
- 1. ADC over-range occurred (1: true, 0: false) [2 byte short]
- Spectrum Data
- 1. Number of points in the spectrum data, k [4 byte int]
 - 2. Start frequency of spectrum data (Hz) [8 byte double]
 - 3. Step frequency of spectrum data (Hz) [8 byte double]
 - 4. FFT bin at 1st point (dBm) [4 byte float]
 - 5. FFT bin at 2nd point (dBm) [4 byte float]
 - ...
 - (k + 3). FFT bin at last (kth) point (dBm) [4 byte float]
-

Initial S/W A.14.00
Revision

Format Data: Numeric Data (Remote Command Only)

This command specifies the format of the trace data input and output. It specifies the formats used for trace data during data transfer across any remote port. It affects only the data format for setting and querying trace data for the :TRACe[:DATA], TRACe[:DATA]?, :CALCulate:DATA[n]? and FETCh:SANalyzer [n]? commands and queries.

Remote Command	:FORMat[:TRACe][:DATA] ASCii INTEger,32 REAL,32 REAL,64 :FORMat[:TRACe][:DATA]?
Notes	The query response is: ASCii: ASC,8 REAL,32: REAL,32 REAL,64: REAL,64 INTEger,32: INT,32 When the numeric data format is REAL or ASCii, data is output in the current Y Axis unit. When the data format is INTEger, data is output in units of m dBm (.001 dBm). The INT,32 format returns binary 32-bit integer values in internal units (m dBm), in a definite length block.
Dependencies	Sending a data format spec with an invalid number (for example, INT,48) generates no error. The analyzer simply uses the default (8 for ASCii, 32 for INTEger, 32 for REAL). Sending data to the analyzer which does not conform to the current FORMat specified, results in an error. Sending ASCII data when a definite block is expected generates message -161 "Invalid Block Data" and sending a definite block when ASCII data is expected generates message -121 "Invalid Character in Number".
Preset	ASCii
Backwards Compatibility	Note that the INT,32 format is only applicable to the command, TRACe:DATA. This preserves

Notes	backwards compatibility for the Swept SA measurement. For all other commands/queries which honor FORMat:DATA, if INT,32 is sent the analyzer will behave as though it were set to REAL,32.
Initial S/W Revision	Prior to A.02.00

The specs for each output type follow:

ASCIi - Amplitude values are in ASCII, in the current Y Axis Unit, one ASCII character per digit, values separated by commas, each value in the form:

SX.YYYYYEsZZ

Where:

S = sign (+ or -)

X = one digit to left of decimal point

Y = 5 digits to right of decimal point

E = E, exponent header

s = sign of exponent (+ or -)

ZZ = two digit exponent

REAL,32 - Binary 32-bit real values in the current Y Axis Unit, in a definite length block.

REAL,64 - Binary 64-bit real values in the current Y Axis Unit, in a definite length block.

Format Data: Byte Order (Remote Command Only)

This command selects the binary data byte order for data transfer and other queries. It controls whether binary data is transferred in normal or swapped mode. This command affects only the byte order for setting and querying trace data for the :TRACe[:DATA], TRACe[:DATA]? , :CALCulate:DATA[n]? and FETCh:SANalyzer[n]? commands and queries.

By definition any command that says it uses FORMat:DATA uses any format supported by FORMat:DATA.

The NORMal order is a byte sequence that begins with the most significant byte (MSB) first, and ends with the least significant byte (LSB) last in the sequence: 1|2|3|4. SWAPped order is when the byte sequence begins with the LSB first, and ends with the MSB last in the sequence: 4|3|2|1.

Remote Command	:FORMat:BORDer NORMal SWAPped :FORMat:BORDer?
Preset	NORMal
Initial S/W Revision	Prior to A.02.00

Meas Setup

Displays the setup menu for the currently selected measurement.

Key Path	Front-panel key
Initial S/W Revision	Prior to A.02.00

Avg/Hold Number

Specifies the number of N averages that will be used for the measurement. After the specified number (average counts) have been averaged, the averaging mode (termination control) setting determines the averaging action.

Key Path	Meas Setup
Mode	WCDMA, C2K, 1xEVDO
Remote Command	[:SENSe]:EVMQpsk:AVERage:COUNT <integer> [:SENSe]:EVMQpsk:AVERage:COUNT? [:SENSe]:EVMQpsk:AVERage[:STATe] OFF ON 0 1 [:SENSe]:EVMQpsk:AVERage[:STATe]?
Example	EVMQ:AVER:COUN 1001 EVMQ:AVER:COUN? EVMQ:AVER OFF EVMQ:AVER?
Preset	10 ON
State Saved	Saved in instrument state.
Min	1
Max	10000
Initial S/W Revision	Prior to A.02.00

Avg Mode

Toggles the averaging mode between Exp (exponential) and Repeat. This selection only affects the averaging result after the number of N averages is reached. The N is set using the Avg/Hold Number key.

Exponential	Each successive data acquisition after the average count is reached, is exponentially weighted and then combined with the existing average.
Repeat	After reaching the average count, the averaging is reset and a new average is started.

Key Path	Meas Setup
Mode	WCDMA, C2K, 1xEVDO
Remote Command	[:SENSe] :EVMQpsk:AVERage:TCONtrol EXPonential REPeat [:SENSe] :EVMQpsk:AVERage:TCONtrol?
Example	EVMQ:AVER:TCON REP EVMQ:AVER:TCON?
Notes	Selects the type of termination control used for averaging. This determines the averaging action after the specified number of frames (average count) is reached. Exponential - Each successive data acquisition after the average count is reached, is exponentially weighted and combined with the existing average. Repeat - After reaching the average count, the averaging is reset and a new average is started.
Preset	REPeat
State Saved	Saved in instrument state.
Range	Exp Repeat
Initial S/W Revision	Prior to A.02.00

Meas Interval

Sets the length of the measurement interval (number of data points) that are used.

Key Path	Meas Setup
Mode	WCDMA, C2K
Remote Command	[:SENSe] :EVMQpsk:SWEep:POINts <integer> [:SENSe] :EVMQpsk:SWEep:POINts?
Example	EVMQ:SWE:POIN 1001 EVMQ:SWE:POIN?
Preset	WCDMA: 2560 C2K: 512
State Saved	Saved in instrument state.
Min	128
Max	WCDMA: 5120 C2K: 1536
Initial S/W Revision	Prior to A.02.00

Limits

Accesses a menu that enables you to change the RMS EVM and Frequency Error limits settings.

Key Path	Meas Setup
Initial S/W Revision	Prior to A.02.00

RMS EVM

Sets the limit for the RMS EVM measurement. This value is used to judge whether the measurement passes or fails the RMS EVM limit.

Key Path	Meas Setup, Limits
Mode	WCDMA, C2K, 1xEVDO
Remote Command	:CALCulate:EVMQpsk:LIMit:RMS <real> :CALCulate:EVMQpsk:LIMit:RMS?
Example	CALC:EVMQ:LIM:RMS 50 CALC:EVMQ:LIM:RMS?
Notes	Sets the limits of RMS EVM which is used to judge the result of RMS EVM passes or fails. If a measured RMS EVM value is not larger than the limit value, the result is PASS. Otherwise, the result is FAIL. You must be in the W-CDMA mode to use this command. Use INSTRument:SElect to set the mode.
Preset	WCDMA: 17.5 C2K: 100.0 1xEVDO: 100.0
Min	0.0
Max	100.0
Initial S/W Revision	Prior to A.02.00

Freq Error

Sets the limit, in Hz, for the frequency error measurement. This value is used to judge whether the measurement passes or fails the Frequency Error limit.

Key Path	Meas Setup, Limits
Mode	WCDMA, C2K, 1xEVDO
Remote Command	:CALCulate:EVMQpsk:LIMit:FERRor <freq> :CALCulate:EVMQpsk:LIMit:FERRor?
Example	CALC:EVMQ:LIM:FERR 100 CALC:EVMQ:LIM:FERR?
Notes	Sets the limits of the Frequency Error, which is used to judge the result of the Frequency Error, whether it passes or fails. If the measured Frequency Error value is not larger than the limit value, the result is PASS. Otherwise, the result is FAIL.
Preset	100.0
State Saved	Saved in instrument state.

Min	0.0
Max	300000
Initial S/W Revision	Prior to A.02.00

Spectrum

Toggles the spectrum function between Normal and Invert. If set to Invert, this function conjugates the spectrum. It is equivalent to taking the negative of the quadrature component in demodulation.

Key Path	Meas Setup
Mode	WCDMA, C2K, 1xEVDO
Remote Command	[:SENSe] :EVMQpsk :SPECTrum NORMal INVert [:SENSe] :EVMQpsk :SPECTrum?
Example	EVMQ:SPEC NORM EVMQ:SPEC?
Preset	NORMal
State Saved	Saved in instrument state.
Range	Normal Invert
Initial S/W Revision	Prior to A.02.00

Meas Preset

Restores all the measurement parameters to their default values.

Key Path	Meas Setup
Mode	WCDMA, C2K, 1xEVDO
Remote Command	:CONFigure:EVMQpsk
Example	CONF:EVMQ
Notes	Restore all defaults of parameters.
Initial S/W Revision	Prior to A.02.00

Advanced

Accesses a menu of functions that enable you to set up more specific parameters for the measurement. These parameters include:

- EVM Result I/Q Offset
- IF Gain
- RRC Filter Control

Filter Alpha
Chip Rate

Key Path	Meas Setup
Initial S/W Revision	Prior to A.02.00

EVM Result I/Q Offset

Toggles the I/Q Offset to be included or excluded in the measurement result. When it is set as "Standard" (ON), EVM is calculated without any compensation of I/Q offset. When it is set as "Exclude" (OFF), I/Q offset is compensated.

Key Path	Meas Setup, Advanced
Mode	WCDMA, C2K, 1xEVDO
Remote Command	:CALCulate:EVMQpsk:IQOffset:INCLude OFF ON 0 1 :CALCulate:EVMQpsk:IQOffset:INCLude?
Example	CALC:EVMQ:IQOF:INCL OFF CALC:EVMQ:IQOF:INCL?
Preset	ON
State Saved	Saved in instrument state.
Range	Std Exclude
Initial S/W Revision	Prior to A.02.00

Chip Rate

Changes the chip rate for the measurement.

Key Path	Meas Setup, Advanced
Mode	WCDMA, C2K, 1xEVDO
Remote Command	[:SENSe] :EVMQpsk :CRATe <freq> [:SENSe] :EVMQpsk :CRATe?
Example	EVMQ:CRAT 2.5 MHz EVMQ:CRAT?
Notes	Enter a frequency value to set the chip rate.
Preset	WCDMA: 3.84 MHz C2K: 1.2288 MHz 1xEVDO: 1.2288 MHz
State Saved	Saved in instrument state.
Min	100 kHz

14 QPSK EVM Measurement
Meas Setup

Max	20 MHz
Initial S/W Revision	Prior to A.02.00

Mode

See "Mode" on page 162

Mode Preset

Returns the active mode to a known state.

Mode Preset does the following for the currently active mode:

- Aborts the currently running measurement.
- Brings up the default menu for the mode, with no active function.
- Sets measurement Global settings to their preset values for the active mode only.
- Activates the default measurement.
- Brings up the default menu for the mode.
- Clears the input and output buffers.
- Sets Status Byte to 0.

Mode Preset does not:

- Cause a mode switch
- Affect mode persistent settings
- Affect system settings
- See "[How-To Preset](#)" on page 2049 for more information.

Key Path	Front-panel key
Remote Command	:SYSTem:PRESet
Example	:SYST:PRES
Notes	*RST is preferred over :SYST:PRES for remote operation. *RST does a Mode Preset, as done by the :SYST:PRES command, and it sets the measurement mode to Single measurement rather than Continuous for optimal remote control throughput. Clears all pending OPC bits. The Status Byte is set to 0.
Couplings	A Mode Preset aborts the currently running measurement, activates the default measurement, and gets the mode to a consistent state with all of the default couplings set.
Backwards Compatibility Notes	In the X-Series, the legacy "Factory Preset" has been replaced with Mode Preset, which only presets the currently active mode, not the entire instrument. In the X-Series, the way to preset the entire instrument is by using System, Restore System Defaults All, which behaves essentially the same way as restore System Defaults does on ESA and PSA. There is also no "Preset Type" as there is on the PSA. There is a green Mode Preset front-panel key that does a Mode Preset and a white-with-green-letters User Preset front-panel key that does a User Preset. The old PRESet:TYPE command is ignored (without generating an error), and SYST:PRES without a parameter does a Mode Preset, which should cover most backward code compatibility issues. The settings and correction data under the Input/Output front-panel key (examples: Input Z Corr, Ext Amp Gain, etc.) are no longer part of any Mode, so they will not be preset by a Mode Preset. They are preset using Restore Input/Output Defaults, Restore System Defaults All. Note that because User Preset does a Recall State, and all of these settings are saved in State, they ARE recalled when using

	User Preset.
Initial S/W Revision	Prior to A.02.00

How-To Preset

The table below shows all possible presets, their corresponding SCPI commands and front-panel access (key paths). Instrument settings depend on the current measurement context. Some settings are local to the current measurement, some are global (common) across all the measurements in the current mode, and some are global to all the available modes. In a similar way, restoring the settings to their preset state can be done within the different contexts.

Auto Couple - is a measurement local key. It sets all Auto/Man parameter couplings in the measurement to Auto. Any Auto/Man selection that is local to other measurements in the mode will not be affected.

Meas Preset - is a measurement local key. Meas Preset resets all the variables local to the current measurement except the persistent ones.

Mode Preset - resets all the current mode's measurement local and measurement global variables except the persistent ones.

Restore Mode Defaults - resets ALL the Mode variables (and all the Meas global and Meas local variables), including the persistent ones.

Type Of Preset	SCPI Command	Front Panel Access
Auto Couple	:COUPlE ALL	Auto Couple front-panel key
Meas Preset	:CONFIgure:<Measurement>	Meas Setup Menu
Mode Preset	:SYSTem:PRESet	Mode Preset (green key)
Restore Mode Defaults	:INSTrument:DEFault	Mode Setup Menu
Restore All Mode Defaults	:SYSTem:DEFault MODEs	System Menu; Restore System Default Menu
*RST	*RST	not possible (Mode Preset with Single)
Restore Input/Output Defaults	:SYSTem:DEFault INPut	System Menu; Restore System Default Menu
Restore Power On Defaults	:SYSTem:DEFault PON	System Menu; Restore System Default Menu
Restore Alignment Defaults	:SYSTem:DEFault ALIGn	System Menu; Restore System Default Menu
Restore Miscellaneous Defaults	:SYSTem:DEFault MISC	System Menu; Restore System Default Menu
Restore All System Defaults	:SYSTem:DEFault [ALL] :SYSTem:PRESet:PERSistent	System Menu; Restore System Default Menu
User Preset	:SYSTem:PRESet:USER	User Preset Menu
User Preset All Modes	:SYSTem:PRESet:USER:ALL	User Preset Menu

14 QPSK EVM Measurement
Mode Preset

Power On Mode Preset	:SYSTem:PON:TYPE MODE	System Menu
Power On User Preset	:SYSTem:PON:TYPE USER	System Menu
Power On Last State	:SYSTem:PON:TYPE LAST	System Menu

Mode Setup

See "[Mode Setup](#)" on page 181

Peak Search

Accesses a menu that enables you to control the peak search function and places a marker on the trace point with highest peak.

Key Path	Front-panel key
Mode	WCDMA, C2K, 1xEVDO
Remote Command	:CALCulate:EVMQpsk:MARKer[1] 2 ...12:MAXimum
Example	CALC:EVMQ:MARK2:MAX
Notes	This command does not work when the selected marker is located on the polar trace. In this case, the command is ignored.
Initial S/W Revision	Prior to A.02.00

Next Peak

Moves the selected marker to the peak that has the next highest amplitude that is less than the marker's current value.

Key Path	Peak Search
Mode	WCDMA, C2K, 1xEVDO
Remote Command	:CALCulate:EVMQpsk:MARKer[1] 2 ...12:MAXimum:NEXT
Example	CALC:EVMQ:MARK2:MAX:NEXT
Notes	This command does not work when the selected marker is located on the polar trace. In this case, the command is ignored.
Initial S/W Revision	Prior to A.02.00

Next Pk Right

Moves the selected marker to the nearest peak to the right of the current marker that meets all enabled peak criteria.

Key Path	Peak Search
Mode	WCDMA, C2K, 1xEVDO
Remote Command	:CALCulate:EVMQpsk:MARKer[1] 2 ...12:MAXimum:RIGHT
Example	CALC:EVMQ:MARK2:MAX:RIGH
Notes	This command does not work when the selected marker is located on the polar trace. In this case, the command is ignored.
Initial S/W Revision	Prior to A.02.00

Next Pk Left

Moves the selected marker to the nearest peak to the left of the current marker that meets all enabled peak criteria.

Key Path	Peak Search
Mode	WCDMA, C2K, 1xEVDO
Remote Command	:CALCulate:EVMQpsk:MARKer [1] 2 . . . 12:MAXimum:LEFT
Example	CALC:EVMQ:MARK2:MAX:LEFT
Notes	This command does not work when the selected marker is located on the polar trace. In this case, the command is ignored.
Initial S/W Revision	Prior to A.02.00

Marker Delta

Sets the control mode for the selected marker to Delta mode. This menu key performs the same function as the Delta 1-of-N selection key in the Marker menu. It is duplicated in the Peak Search Menu to allow you the convenience to simultaneously perform a peak search and change the marker control mode to Delta without having to access two separate menus.

Key Path	Peak Search
Initial S/W Revision	Prior to A.02.00

Pk-Pk Search

Finds and displays the amplitude and frequency (or time, if in zero span) differences between the highest and lowest value on the y-axis.

Key Path	Peak Search
Mode	WCDMA, C2K, 1xEVDO
Remote Command	:CALCulate:EVMQpsk:MARKer [1] 2 . . . 12:PTPeak
Example	CALC:EVMQ:MARK:PTP
Notes	This command does not work when the selected marker is located on the polar trace. In this case, the command is ignored.
Couplings	This key is not available (key is grayed out) when Coupled Markers is on.
Initial S/W Revision	Prior to A.02.00

Min Search

Moves the selected marker to the minimum value on the y-axis of the current trace.

Key Path	Peak Search
Mode	WCDMA, C2K, 1xEVDO
Remote Command	:CALCulate:EVMQpsk:MARKer[1] 2 ...12:MINimum
Example	CALC:EVMQ:MARK:MIN
Notes	This command does not work when the selected marker is located on the polar trace. In this case, the command is ignored.
Initial S/W Revision	Prior to A.02.00

Print

See "Print " on page 188

Quick Save

The Quick Save front-panel key repeats the most recent save that was performed from the Save menu, with the following exceptions:

- Register saves are not remembered as Saves for the purpose of the Quick Save function
- If the current measurement does not support the last non-register save that was performed, an informational message is generated, “File type not supported for this measurement”

Quick Save repeats the last type of qualified save (that is, a save qualified by the above criteria) in the last save directory by creating a unique filename using the Auto File Naming algorithm described below.

If Quick Save is pressed after startup and before any qualified Save has been performed, the Quick Save function performs a Screen Image save using the current settings for Screen Image saves (current theme, current directory), which then becomes the “last save” for the purpose of subsequent Quick Saves.

The Auto File Naming feature automatically generates a file name for use when saving a file. The filename consists of a prefix and suffix separated by a dot, as is standard for the Windows® file system. A default prefix exists for each of the available file types:

Type	Default Prefix	Menu
State	State_	(Save/Recall)
Trace + State	State_	(Save/Recall)
Screen	Screen_	(Save/Recall)
Amplitude Corrections	Ampcor_	(Import/Export)
Traces	Trace_	(Import/Export)
Limit Lines	LLine_	(Import/Export)
Measurement Result	MeasR_	(Import/Export)
Capture Buffer	CapBuf_	(Import/Export)

A four digit number is appended to the prefix to create a unique file name. The numbering sequence starts at 0000 within each Mode for each file type and updates incrementally to 9999, then wraps to 0000 again. It remembers where it was through a Mode Preset and when leaving and returning to the Mode. It is reset by Restore Misc Defaults and Restore System Defaults and subsequent running of the instrument application. So, for example, the first auto file name generated for State files is State_0000.state. The next is State_0001, and so forth.

One of the key features of Auto File Name is that we guarantee that the Auto File Name will never conflict with an existing file. The algorithm looks for the next available number. If it gets to 9999, then it looks for holes. If it find no holes, that is no more numbers are available, it gives an error.

For example, if when we get to State_0010.state there is already a State_0010.state file in the current directory, it advances the counter to State_0011.state to ensure that no conflict will exist (and then it verifies that State_0011.state also does not exist in the current directory and advances again if it does, and so forth).

If you enter a file name for a given file type, then the prefix becomes the filename you entered instead of the default prefix, followed by an underscore. The last four letters (the suffix) are the 4-digit number.

For example, if you save a measurement results file as “fred.csv”, then the next auto file name chosen for a measurement results save will be fred_0000.csv.

NOTE

Although 0000 is used in the example above, the number that is used is actually the current number in the Meas Results sequence, that is, the number that would have been used if you had not entered your own file name.

NOTE

If the filename you entered ends with _dddd, where d=any number, making it look just like an auto file name, then the next auto file name picks up where you left off with the suffix being dddd + 1.

Key Path	Front-panel key
Notes	No remote command for this key specifically.
Initial S/W Revision	Prior to A.02.00

Recall

The Recall menu lets you choose what you want to recall, and where you want to recall it from. Among the types of files you can recall are **States and Traces**. In addition, an Import (Data) option lets you recall a number of data types stored in CSV files (as used by Excel and other spreadsheet programs).

NOTE

In products that run multiple instances of the X-Series Application, all instances share the same register and file location where you want to recall from.

The default paths for Recall are data type dependent and are the same as for the Save key.

Key Path	Front-panel key
Notes	<p>No remote command for this key specifically, but the :MMEM:LOAD command is available for specific file types. An example is :MMEM:LOAD:STATe <filename>.</p> <p>If you try to recall a State file for a mode that is not licensed or not available in the instrument, an error message will occur and the state will not change.</p>
Backwards Compatibility Notes	<p>In legacy analyzers, it was possible to load a state without affecting the trace data, limit lines or correction data. Similarly (since User Preset is actually loading a state), it was possible to do a User Preset without affecting the trace data, limit lines or correction data.</p> <p>In the X-Series, "state" always includes all of this data; so whenever state is loaded, all of the traces, limit lines and corrections are affected. Although this differs from previous behavior, it is desirable behavior, and should not cause adverse issues for users.</p>
Backwards Compatibility Notes	<p>Recall for the X-Series supports backward compatibility in the sense that you can recall a state file from any X-Series model number and any version of X-Series software. This is only possible if part of the recalling process goes through a limiting step after recalling the mode settings, at least for settings that may vary with version number, model number, option and license differences. If you try to recall a state file onto an instrument with less capability than what was available on the instrument during the save, the recall will ignore the state it doesn't support and it will limit the recalled setting to what it allows.</p> <p>Example: if the saved state includes preamp ON, but the recalling instrument does not have a preamp; the preamp is limited to OFF. Conversely, if you save a state without a preamp, the preamp is OFF in the state file. When this saved file is recalled on an instrument with a licensed preamp, the preamp is changed to OFF. Another example is if the saved state has center frequency set to 20 GHz, but the instrument recalling the saved state is a different model and only supports 13.5 GHz. In this case, the center frequency is limited along with any other frequency based settings. Since the center frequency can't be preserved in this case, the recall limiting tries to at least preserve span to keep the measurement setup as intact as possible.</p> <p>It may be appropriate to issue a warning if the state is limited on the recall; warnings do not go out to SCPI so this would only affect the manual user.</p> <p>Note that there is no state file compatibility outside of the X-Series. For example, you cannot recall a state file from ESA or PSA.</p>
Initial S/W Revision	Prior to A.02.00

State

The Recall State menu lets you choose a register or file from which to recall the state.

The content of a state file includes all of the settings and data required to return the analyzer as closely as possible to the Mode it was in, with the exact settings that were in place, when the save occurred. The Mode settings in each state file include the settings that are affected by Mode Preset, as well as the additional settings affected by Restore Mode Defaults; all of the Mode's settings. In addition, all of the settings of the Input/Output system are included, even though they are outside of the Mode's state, because they are needed to restore the complete setup. Persistent System settings (for example, GPIB address) are not affected by either a Mode Preset or Restore Mode Defaults, nor are they included in a saved State file.

Since each state file is only for one Mode, the settings for other Modes are unaffected when it is loaded. Recall State will cause a mode switch if the state being recalled is not from the current active mode.

After the recall completes, the message "File <filename> recalled" or "Recalled State Register <register number>" is displayed.

For rapid recalls, the State menu lists 16 registers that you can choose from to recall. Pressing a Register key initiates the recall. You can also select a file from which to recall.

The default path for all State Files is:

My Documents\<<mode name>\state

where <mode name> is the parameter used to select the mode with the INST:SEL command (for example, SA for the Spectrum Analyzer).

See ["More Information" on page 2060](#).

Key Path	Recall
Mode	All
Remote Command	:MMEMory:LOAD:STATe <filename>
Example	:MMEM:LOAD:STAT "myState.state" This recalls the file myState.state on the default path
Example	MMEM:LOAD:STAT "MyStateFile.state" This loads the state file data (on the default file directory path) into the instrument state.
Notes	<p>When you pick a file to recall, the analyzer first verifies that the file is recallable in the current instrument by checking the software version and model number of the instrument. If everything matches, a full recall proceeds by aborting the currently running measurement, clearing any pending operations, and then loading the State from the saved state file. You can open state files from any mode, so recalling a State file switches to the mode that was active when the save occurred. After switching to the mode of the saved state file, mode settings and data (if any for the mode) are loaded with values from the saved file. The saved measurement of the mode becomes the newly active measurement and the data relevant to the measurement (if there is any) is recalled.</p> <ul style="list-style-type: none"> • If there is a mismatch between file version or model number or instrument version or model number, the recall function tries to recall as much as possible and returns a warning message. It may limit settings that differ based on model number, licensing or version number. <p>After recalling the state, the Recall State function does the following:</p> <ul style="list-style-type: none"> • Makes the saved measurement for the mode the active measurement. • Clears the input and output buffers. • Status Byte is set to 0.

	<ul style="list-style-type: none"> • Executes a *CLS <p>If the file specified is empty an error is generated. If the specified file does not exist, another error is generated. If there is a mismatch between the file and the proper file type, an error is generated. If there is a mismatch between file version or model number or instrument version or model number, a warning is displayed. Then it returns to the State menu and File Open dialog goes away.</p> <p>After the Recall, the analyzer exits the Recall menu and returns to the previous menu.</p>
Backwards Compatibility SCPI	:MMEMory:LOAD:STATe 1,<filename>
Initial S/W Revision	Prior to A.02.00

More Information

In measurements that support saving Traces, for example, Swept SA, the Trace data is saved along with the State in the State file. When recalling the State, the Trace data is recalled as well. Traces are recalled exactly as they were stored, including the writing mode and update and display modes. If a Trace was updating and visible when the State was saved, it will come back updating and visible, and its data will be rewritten right away. When you use State to save and recall traces, any trace whose data must be preserved should be placed in View or Blank mode before saving.

The following table describes the Trace Save and Recall possibilities:

You want to recall state and one trace's data, leaving other traces unaffected.	Save Trace+State from 1 trace. Make sure that no other traces are updating (they should all be in View or Blank mode) when the save is performed.	On Recall, specify the trace you want to load the one trace's data into. This trace will load in View. All other traces' data will be unaffected, although their trace mode will be as it was when the state save was performed.
You want to recall all traces	Save Trace+State from ALL traces.	On Recall, all traces will come back in View (or Blank if they were in Blank or Background when saved)
You want all traces to load exactly as they were when saved.	Save State	On recall, all traces' mode and data will be exactly as they were when saved. Any traces that were updating will have their data immediately overwritten.

From File...

When you press "From File", the analyzer brings up a Windows dialog and a menu entitled "File Open." This menu allows you to navigate to the various fields in the Windows dialog without using a keyboard or mouse. The Tab and Arrow keys can also be used for dialog navigation.

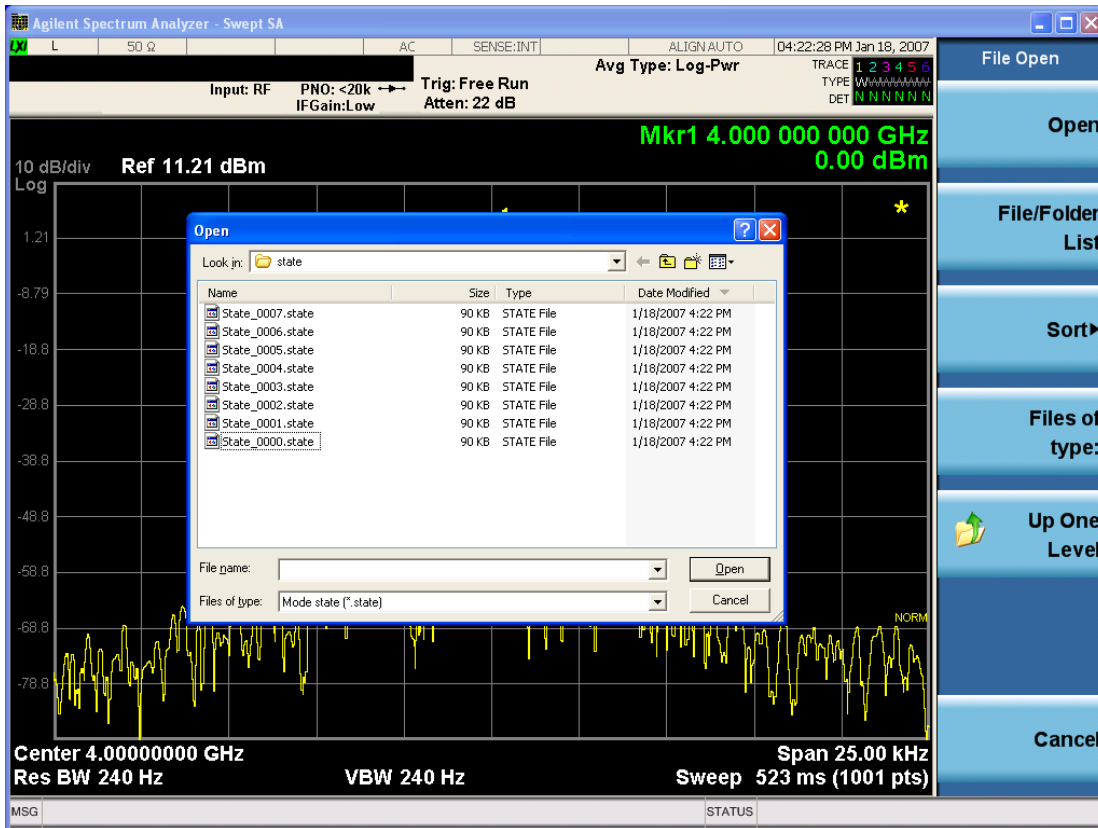

Listed below are the functions of the various fields in the dialog, and the corresponding softkeys:

Open

Performs the recall of the specified file. While the recall is being performed, the floppy icon appears briefly in the Meas bar.

File/Folder List

Enables you to navigate to the center of the dialog that contains the list of files and folders. Once here you can get information about the file and use the tab keys to navigate to the other fields in the dialog, such as Look In.

Look In

The Look In field shows the path from which the file will be recalled and allows you to change the path using the up and down arrow keys to navigate to other paths; the Enter key to open a directory; and the Backspace key to go back one directory. The **Look In field** first uses the last path from the Save As dialog **Save In:** path for that same file type. There is no softkey for directly navigating to the Look In field, but you can use the left tab to get here from the File/Folder List.

User specified paths are remembered when you leave and return to a Mode and are reset back to the default using Restore Mode Defaults.

Sort

Accesses a menu that enables you to sort the files within the File Open dialog. Only one sorting type can be selected at a time and the sorting happens immediately. The sorting types are By Date, By Name, By extension, and By Size.

Files of Type

This field shows the file suffix for the type of file you have selected to recall. For example, if you navigated here while recalling State, "Mode state (*.state)" is in the field. If you navigated here while recalling Trace, ""Mode state (*.trace)" is in the field. If you navigated here while importing a trace data file, "Trace Data (*.csv)" is in the field. For some file types, there is more than one choice in the dropdown menu, which you can select by using the up and down arrow keys and Enter.

Up One Level

This key corresponds to the icon of a folder with the up arrow that is in the tool bar of the dialog. When pressed, it causes the file and folder list to navigate up one level in the directory structure. The Backspace key does the same thing.

Cancel

This key corresponds to the Cancel selection in the dialog. It causes the current **Open** request to be cancelled. The ESC key does the same thing.

Key Path	Recall, State
Notes	Brings up the Open dialog for recalling a State Save Type
Initial S/W Revision	Prior to A.02.00

Edit Register Names

You may enter a custom name on any of the Register keys, to help you remember what you are using that state to save. To do this, press the Edit Register Names key, choose the register whose name you wish to edit, and then enter the desired label using the Alpha Editor or an external PC keyboard.

The maximum number of characters that can be added is 30. In most cases, 30 characters will fit on two lines of the key.

For more information and the SCPI command, see Edit Register Names under the Save, State function.

Key Path	Recall, State
Mode	All
Dependencies	N9060A-7FP or N9060B-2FP license required to edit the register names. When the feature is not licensed, sending the SCPI command generates an error, -221, "Settings conflict;Option not available"
Initial S/W Revision	A.11.00

Register 1 thru Register 16

Selecting any one of these register keys causes the State of the mode from the specified Register to be recalled. Each of the register keys annotates whether it is empty or at what date and time it was last

modified. In addition, you can use the Edit Register Names key under Save, State to enter custom names for each register.

NOTE

In products that run multiple instances of the X-Series Application, recalling the same register name on each instance is a way to share setups between the instances.

Registers are shared by all modes, so recalling from any one of the registers will cause a mode switch to the mode that was active when the save to the Register occurred.

Although these 16 registers are the only registers available from the front panel, there are 128 state registers available in the instrument. Registers 17–128 are only available from the SCPI interface, using the *RCL command.

After the recall completes, the message "Register <register number> recalled" appears in the message bar. If you are in the Spectrum Analyzer Mode, and you are recalling a register that was saved in the Spectrum Analyzer Mode, then after the recall, you will still be in the Recall Register menu. If the Recall causes you to switch modes, then after the Recall, you will be in the Frequency menu.

If a requested register is empty an error is generated.

Key Path	Recall, State
Example	*RCL 1
Range	1–16 from front panel, 1–128 from SCPI
Readback	Date and time with seconds resolution are displayed on the key OR A custom name of up to 30 characters entered using the Save, State, Edit Register Names key OR “(empty)” if no prior save operation has been performed to this register.
Initial S/W Revision	Prior to A.02.00
Modified at S/W Revision	Prior to A.11.00

Register 1 thru Register 16

Selecting any one of these register keys causes the State of the mode from the specified Register to be recalled. Each of the register keys annotates whether it is empty or at what date and time it was last modified. In addition, you can use the Edit Register Names key under Save, State to enter custom names for each register.

NOTE

In products that run multiple instances of the X-Series Application, recalling the same register name on each instance is a way to share setups between the instances.

Registers are shared by all modes, so recalling from any one of the registers will cause a mode switch to the mode that was active when the save to the Register occurred.

Although these 16 registers are the only registers available from the front panel, there are 128 state registers available in the instrument. Registers 17–128 are only available from the SCPI interface, using the *RCL command.

After the recall completes, the message "Register <register number> recalled" appears in the message bar. If you are in the Spectrum Analyzer Mode, and you are recalling a register that was saved in the Spectrum Analyzer Mode, then after the recall, you will still be in the Recall Register menu. If the Recall causes you to switch modes, then after the Recall, you will be in the Frequency menu.

If a requested register is empty an error is generated.

Key Path	Recall, State
Example	*RCL 1
Range	1-16 from front panel, 1-128 from SCPI
Readback	Date and time with seconds resolution are displayed on the key OR A custom name of up to 30 characters entered using the Save, State,Edit Register Names key OR "(empty)" if no prior save operation has been performed to this register.
Initial S/W Revision	Prior to A.02.00
Modified at S/W Revision	Prior to A.11.00

Sequences

These keys allow you to import a Tab separated or .txt file that will automatically setup all the parameters required for building a Sequence. The parameters will automatically be loaded into the Stated Sequencer.

Once selected, in order to import the selected Sequence Type you must select the Open key in the Source Sequence menu.

Key Path	Recall, Sequences
Mode	All
Remote Command	:MMEMory:LOAD:SEQuences: SLISt ALISt SAALISt "MySequence.txt"
Example	:MMEM:LOAD:SEQ:SLIS "MySequence.txt"
Notes	Available file types are: –CSV (Comma delimited) (*.csv) –Text (Tab delimited) (*.txt)
Initial S/W Revision	A.05.00

Source Sequence

The list of parameters, that configure steps, that makes up a sequence for the Source.

The Source sequence is a sequence of flexible configurable steps that can be set anywhere in the instruments frequency range.

Key Path	Recall,Sequences
----------	------------------

Example	:MMEM:LOAD:SEQ:SLIS "MySequence.txt"
Dependencies	Only available in XOBT
Initial S/W Revision	A.05.00

Open...

When you press "Open", the analyzer brings up a Windows dialog and a menu entitled "File Open." This menu allows you to navigate to the various fields in the Windows dialog without using a keyboard or mouse. The Tab and Arrow keys can also be used for dialog navigation.

See "[From File...](#)" on page 2060 in Recall, State, for a full description of this dialog and menu.

Key Path	Recall, Data
Notes	The key location is mode-dependent and will vary. Brings up Open dialog for recalling a <mode specific> Save Type
Initial S/W Revision	Prior to A.02.00

Data (Import)

Importing a data file loads data that was previously saved from the current measurement or from other measurements and/or modes that produce compatible data files. The Import Menu only contains Data Types that are supported by the current measurement.

Since the commonly exported data files are in .csv format, the data can be edited by the user prior to importing. This allows you to export a data file, manipulate the data in Excel (the most common PC Application for manipulating .csv files) and then import it.

Importing Data loads measurement data from the specified file into the specified or default destination, depending on the data type selected. Selecting an Import Data menu key will not actually cause the importing to occur, since the analyzer still needs to know from where to get the data. Pressing the Open key in this menu brings up the Open dialog and Open menu that provides you with the options from where to recall the data. Once a filename has been selected or entered in the Open menu, the recall occurs as soon as the Open button is pressed.

Key Path	Recall
Mode	All
Notes	The menu is built from whatever data types are available for the mode. Some keys will be missing completely, so the key locations in the sub-menu will vary. No SCPI command directly controls the Data Type that this key controls. The Data Type is included in the MMEM:LOAD commands.
Dependencies	If a file type is not used by a certain measurement, it is grayed out for that measurement. The key for a file type will not show at all if there are no measurements in the Mode that support it.
Preset	Is not affected by Preset or shutdown, but is reset during Restore Mode Defaults

Readback	The data type that is currently selected
Initial S/W Revision	Prior to A.02.00

Capture Buffer

Capture buffer functionality is available only in Code Domain and Modulation Accuracy measurements. The captured data is raw data which is not processed.

Key Path	Recall, Data
Mode	CDMA2000
Example	MMEM:LOAD:CAPT "MyCaptureData.bin" This loads the file of capture data (on the default file directory path) into the instrument.
Dependencies	Capture buffer data is only available for Code Domain and Modulation Accuracy measurement. In other measurements, this key is grayed out.

Open...

When you press "Open", the analyzer brings up a Windows dialog and a menu entitled "File Open." This menu allows you to navigate to the various fields in the Windows dialog without using a keyboard or mouse. The Tab and Arrow keys can also be used for dialog navigation.

See "[From File...](#)" on page 2060 in Recall, State, for a full description of this dialog and menu.

Key Path	Recall, Data
Notes	The key location is mode-dependent and will vary. Brings up Open dialog for recalling a <mode specific> Save Type
Initial S/W Revision	Prior to A.02.00

Restart

The Restart function restarts the current sweep, or measurement, or set of averaged/held sweeps or measurements. If you are Paused, pressing Restart does a Resume.

The Restart function is accessed in several ways:

- Pressing the Restart key
- Sending the remote command INIT:IMMEDIATE
- Sending the remote command INIT:RESTART

See "[More Information](#)" on page 2067

Key Path	Front-panel key
Remote Command	:INITiate[:IMMEDIATE] :INITiate:RESTART
Example	:INIT:IMM :INIT:REST
Notes	:INITiate:RESTART and :INITiate:IMMEDIATE perform exactly the same function.
Couplings	Resets average/hold count k. For the first sweep overwrites all active (update=on) traces with new current data. For application modes, it resets other parameters as required by the measurement.
Status Bits/OPC dependencies	This is an Overlapped command. The STATUS:OPERation register bits 0 through 8 are cleared. The STATUS:QUESTIONable register bit 9 (INTEgrity sum) is cleared. The SWEEPING bit is set. The MEASURING bit is set.
Backwards Compatibility Notes	For Spectrum Analysis mode in ESA and PSA, the Restart hardkey and the INITiate:RESTART command restart trace averages (displayed average count reset to 1) for a trace in Clear Write, but did not restart Max Hold and Min Hold. In the X-Series, the Restart hardkey and the INITiate:RESTART command restart not only Trace Average, but MaxHold and MinHold traces as well. For wireless comms modes in ESA and PSA, the Restart hardkey and the INITiate:RESTART command restart every measurement, which includes all traces and numeric results. There is no change to this operation.
Initial S/W Revision	Prior to A.02.00

More Information

The **Restart** function first aborts the current sweep/measurement as quickly as possible. It then resets the sweep and trigger systems, sets up the measurement and initiates a new data measurement sequence with a new data acquisition (sweep) taken once the trigger condition is met.

If the analyzer is in the process of aligning when **Restart** is executed, the alignment finishes before the restart function is performed.

Even when set for Single operation, multiple sweeps may be taken when Restart is pressed (for example, when averaging/holding is on). Thus when we say that **Restart** "restarts a measurement," we may mean:

- It restarts the current sweep
- It restarts the current measurement
- It restarts the current set of sweeps if any trace is in Trace Average, Max Hold or Min Hold
- It restarts the current set of measurements if Averaging, or Max Hold, or Min Hold is on for the measurement
- depending on the current settings.

With **Average/Hold Number** (in **Meas Setup** menu) set to 1, or Averaging off, or no trace in Trace Average or Hold, a single sweep is equivalent to a single measurement. A single sweep is taken after the trigger condition is met; and the analyzer stops sweeping once that sweep has completed. However, with **Average/Hold Number** >1 and at least one trace set to **Trace Average, Max Hold, or Min Hold (SA Measurement)** or **Averaging on (most other measurements)**, multiple sweeps/data acquisitions are taken for a single measurement. The trigger condition must be met prior to each sweep. The sweep is stopped when the average count k equals the number N set for **Average/Hold Number**. A measurement average usually applies to all traces, marker results, and numeric results; but sometimes it only applies to the numeric results.

Once the full set of sweeps has been taken, the analyzer will go to idle state. To take one more sweep without resetting the average count, increment the average count by 1, by pressing the step up key while **Average/Hold Number** is the active function, or sending the remote command CALC:AVER:TCON UP.

Save

The Save menu lets you choose what you want to save and where you want to save it. Among the types of files you can save are **States**, **Traces**, and **Screen Images**. In addition, an Export (Data) option lets you save a number of data types as CSV files for easy import into Excel and other spreadsheet programs.

Key Path	Front-panel key
Mode	All
Notes	No remote command for this key specifically, but the :MMEM:STORe command is available for specific file types. An example is :MMEM:STOR:STATe <filename>.
Initial S/W Revision	Prior to A.02.00

State

The Save State menu lets you choose a register or file for saving the state.

NOTE

In products that run multiple instances of the X-Series Application, all instances share the same register and file location where you want to save the state.

The content of a state file includes all of the settings and data required to return the analyzer as closely as possible to the Mode it was in, with the exact settings which were in place, when the save occurred. The Mode settings in each state file include the settings that are affected by Mode Preset, as well as the additional settings affected by Restore Mode Defaults; all of the Mode's settings. In addition, all of the settings of the Input/Output system are included, even though they are outside of the Mode's state, because they are needed to restore the complete setup. Persistent System settings (for example, Verbose SCPI) are not affected by either Mode Preset or Restore Mode Defaults, nor are they included in a saved State file.

After the save completes, the message "File <filename> saved" or "State Register <register number> saved" is displayed.

For rapid saving, the State menu lists 16 registers to save to. Pressing a Register key initiates the save. You can also select a file to save to.

The default path for all State Files is:

My Documents\<<mode name>\state

where <mode name> is the parameter used to select the mode with the INST:SEL command (for example, SA for the Spectrum Analyzer).

Key Path	Save
Mode	All
Remote Command	:MMEMory:STORe:STATe <filename>
Example	MMEM:STOR:STATe "MyStateFile.state" This stores the current instrument state data in the file MyStateFile.state in the default directory.
Notes	Both single and double quotes are supported for any filename parameter over remote.

After saving to a register, that register's menu key is updated with the date the time, unless a custom label has been entered for that key.

After saving to a register, you remain in the Save State menu, so that you can see the Register key update. After saving to a file, the analyzer automatically returns to the previous menu and any Save As dialog goes away.

Backwards :MMEMory:STORE:STATE 1,<filename>

Compatibility SCPI For backwards compatibility, the above syntax is supported. The "1" is simply ignored. The command is sequential.

Initial S/W Revision Prior to A.02.00

To File . . .

When you press "To File", the analyzer brings up a Windows dialog and a menu entitled "Save As." This menu allows you to navigate to the various fields in the Windows dialog without using a keyboard or mouse. The Tab and Arrow keys can also be used for dialog navigation.

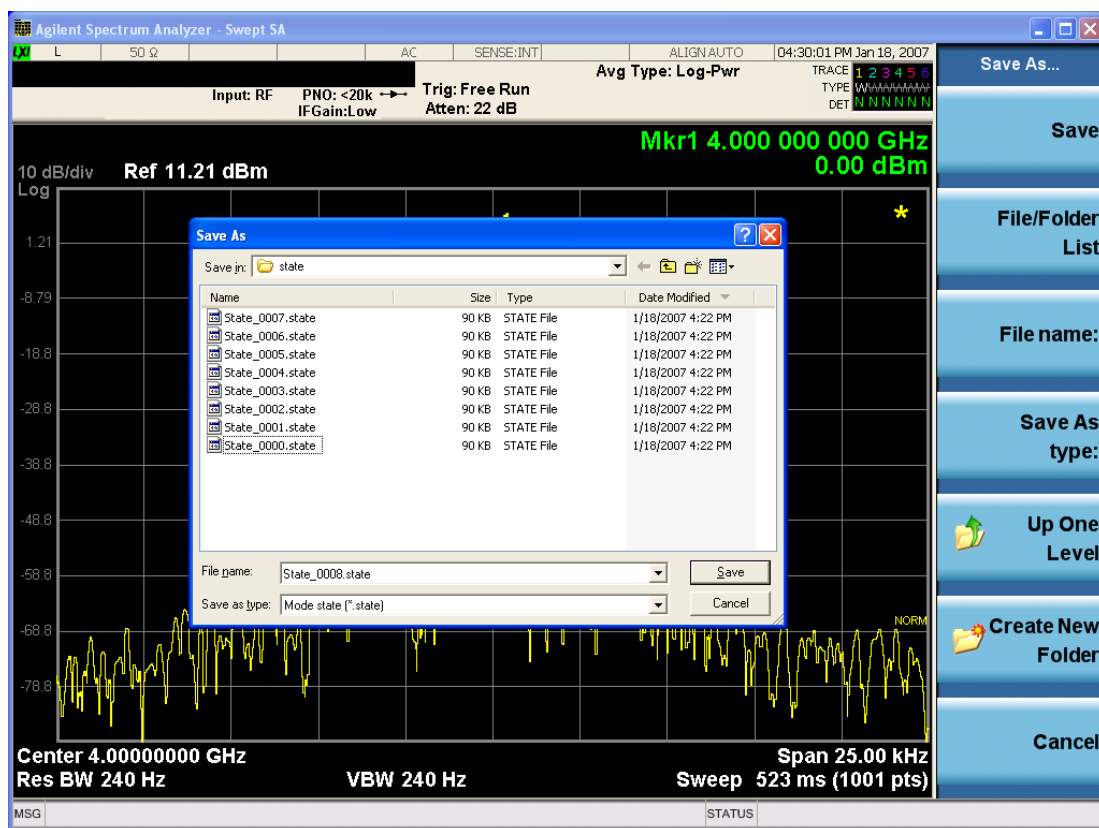

The Listed below

are the functions of the various fields in the dialog, and the corresponding softkeys:

Save

Performs the save to the specified file of the selected type. If the file already exists, a dialog will appear that allows you to replace the existing file by selecting OK, or you can Cancel the request. If you select OK,

the file will be overwritten. Using the C: drive is strongly discouraged, since it runs the risk of being overwritten during an instrument software upgrade.

While the save is being performed, the floppy icon appears briefly in the Meas bar.

File/Folder List

Enables you to navigate to the center of the dialog that contains the list of files and folders. Once here you can get information about the file and use the tab keys to navigate to the other fields in the dialog, such as Save In.

Save In

The Save In field shows the path to which the file will be saved and allows you to change the path using the up and down arrow keys to navigate to other paths; the Enter key to open a directory; and the Backspace key to go back one directory. The **Save In field** defaults to the default path for this type of file and remembers the last path you used to save this type of file. There is no softkey for directly navigating to the Save In field but you can use left tab to get here from the File/Folder List.

User specified paths are remembered when you leave and return to a Mode and are reset back to the default using Restore Mode Defaults.

File Name

The File Name field is initially loaded with an automatically generated filename specific to the appropriate Save Type. The automatically generated filename is guaranteed not to conflict with any filename currently in the directory. You may replace or modify this filename using the File Name key. See the ["Quick Save " on page 2056](#) documentation for more on the automatic file naming algorithm.

When you press the File Name key the analyzer displays the Alpha Editor. Use the knob to choose the letter to add and the front-panel Enter key to add the letter to the file name. The BK character moves you back and the FW character moves you forward in the filename. The Select key on the front panel generates a space character. When you are done entering the filename press the Done softkey. This returns back to the **File Open** dialog and menu, but does not cause the save to occur.

Save As Type

This field shows the file suffix for the type of file you have selected to save. For example, if you navigated here while saving State, "Mode state (*.state)" is in the field. If you navigated here from saving Trace, ""Mode state (*.trace)" is in the field. If you navigated here while exporting a trace data file, "Trace Data (*.csv)" is in the field. For some file types, there is more than one choice in the dropdown, which you can select by using the up and down arrow keys and Enter.

Up One Level

This key corresponds to the icon of a folder with the up arrow that is in the tool bar of the dialog. When pressed, it causes the file and folder list to navigate up one level in the directory structure. The Backspace key does the same thing.

Create New Folder

This key corresponds to the icon of a folder with the "*" that is in the tool bar of the dialog. When pressed, a new folder is created in the current directory with the name **New Folder** and you can enter a new folder name using the Alpha Editor.

Cancel

This key corresponds to the Cancel selection in the dialog. It causes the current **Save As** request to be cancelled. The ESC key does the same thing.

Key Path	Save, State
Mode	All
Notes	Brings up Save As dialog for saving a State Save Type
Initial S/W Revision	Prior to A.02.00

Edit Register Names

You may enter a custom name on any of the Register keys, to help you remember what you are using that state to save. To do this, press the Edit Register Names key, choose the register whose name you wish to edit, and then enter the desired label using the Alpha Editor or an external PC keyboard.

The maximum number of characters that can be added is 30. In most cases, 30 characters will fit on two lines of the key.

See ["More Information" on page 2072](#)

Key Path	Save, State
Mode	All
Remote Command	:MMEMory:REGister:STATe:LABel <reg number>,"label" :MMEMory:REGister:STATe:LABel? <reg number>
Example	:MMEM:REG:STAT:LAB 1,"my label"
Notes	<reg number> is an integer from 1 to 16. If the SCPI specifies an invalid register number an error message is generated, -222,"Data out of range;Invalid register label number" "label" is a string from 0 to 30 characters in length. If a label exceeds 30 characters, an error message is generated, -150,"String data error;Label clipped to 30 characters" "label" of length 0 erases the custom label and restores the default (time and date) label. E.g.: :MMEM:REG:STAT:LAB 1,""
Dependencies	N9060A-7FP or N9060B-2FP license required to edit the register names. When the feature is not licensed, sending this command generates an error, -221,"Settings conflict;Option not available"
Preset	The names are unaffected by Preset or power cycle but are set to the default label (time and date) on a "Restore System Defaults->Misc"
Initial S/W Revision	A.11.00

More Information

When you edit one of the register names, the time and date field will be replaced by the custom name.

If you delete all the characters in the custom name, it restores the default (time and date).

The register names are stored within the state files, but they are not part of the instrument state; that is, once you have edited a register name, loading a new state will not change that register name. Another

consequence of this is that the names will be persistent through a power cycle. Also, if a named state file is transferred to another analyzer, it will bring its custom name along with it.

If you try to edit the name of an empty register, the analyzer will first save the state to have a file to put the name in. If you load a named state file into an analyzer with older firmware it will ignore the metadata.

The *SAV and *RCL commands will not be affected by the custom register names, nor will the MMEM commands.

Register 1 thru Register 16

Selecting any one of these register menu keys causes the State of the currently active mode to be saved to the specified Register. The registers are provided for rapid saving and recalling, since you do not need to specify a filename or navigate to a file. Each of the register menu keys annotates whether it is empty or at what date and time it was last modified. In addition, you can use the Edit Register Names key to enter custom names for each register.

NOTE

In products that run multiple instances of the X-Series Application, save with different register name if you do not want to overwrite the register of another running instance.

Although these 16 registers are the only registers available from the front panel, there are 128 state registers available in the instrument. Registers 17–128 are only available from the SCPI interface, using the *SAV command.

There is one set of 128 state registers in the instrument, not one set for each Mode. When a state is saved, the Mode it was saved from is saved with it; then when it is recalled, the instrument switches to that Mode.

After the save completes, the corresponding register menu key annotation is updated with the date and time and the message "Register <register number> saved" is displayed.

Key Path	Save, State
Mode	All
Example	*SAV 1
Range	1–16 from front panel, 1–128 from SCPI
Readback	Date and time with seconds resolution are displayed on the key OR A custom name of up to 30 characters entered using the Edit Register Names key OR “(empty)” if no prior save operation has been performed to this register.
Initial S/W Revision	Prior to A.02.00
Modified at S/W Revision	A.11.00

Register 1 thru Register 16

Selecting any one of these register menu keys causes the State of the currently active mode to be saved to the specified Register. The registers are provided for rapid saving and recalling, since you do not need to specify a filename or navigate to a file. Each of the register menu keys annotates whether it is empty or at

what date and time it was last modified. In addition, you can use the Edit Register Names key to enter custom names for each register.

NOTE

In products that run multiple instances of the X-Series Application, save with different register name if you do not want to overwrite the register of another running instance.

Although these 16 registers are the only registers available from the front panel, there are 128 state registers available in the instrument. Registers 17–128 are only available from the SCPI interface, using the *SAV command.

There is one set of 128 state registers in the instrument, not one set for each Mode. When a state is saved, the Mode it was saved from is saved with it; then when it is recalled, the instrument switches to that Mode.

After the save completes, the corresponding register menu key annotation is updated with the date and time and the message "Register <register number> saved" is displayed.

Key Path	Save, State
Mode	All
Example	*SAV 1
Range	1–16 from front panel, 1–128 from SCPI
Readback	Date and time with seconds resolution are displayed on the key OR A custom name of up to 30 characters entered using the Edit Register Names key OR “(empty)” if no prior save operation has been performed to this register.
Initial S/W Revision	Prior to A.02.00
Modified at S/W Revision	A.11.00

Mass Storage Catalog (Remote Command Only)

Key path	SCPI Only
Remote Command	:MMEMory:CATalog? [<directory_name>]
Notes	The string must be a valid logical path. Queries disk usage information (drive capacity, free space available) and obtains a list of files and directories in a specified directory in the following format: <numeric_value>,<numeric_value>,{<file_entry>} It returns two numeric parameters and as many strings as there are files and directories. The first parameter indicates the total amount of storage currently used in bytes. The second parameter indicates the total amount of storage available, also in bytes. The <file_entry> is a string. Each <file_entry> indicates the name, type, and size of one file in the directory list: <file_name>,<file_type>,<file_size> As the windows file system has an extension that indicates file type, <file_type> is always empty. <file_size> provides the size of the file in bytes. For directories, <file_entry> is surrounded by square brackets and both <file_type> and <file_size> are empty
Initial S/W Revision	Prior to A.02.00

Mass Storage Change Directory (Remote Command Only)

Key path	SCPI Only
Remote Command	:MMEMory:CDIRectory [<directory_name>] :MMEMory:CDIRectory?
Notes	<p>The string must be a valid logical path.</p> <p>Changes the default directory for a mass memory file system. The <directory_name> parameter is a string. If no parameter is specified, the directory is set to the *RST value.</p> <p>At *RST, this value is set to the default user data storage area, that is defined as System.Environment.SpecialFolder.Personal.</p> <p>Query returns full path of the default directory.</p>
Initial S/W Revision	Prior to A.02.00

Mass Storage Copy (Remote Command Only)

Key path	SCPI Only
Remote Command	:MMEMory:COPY <string>,<string>[,<string>,<string>]
Notes	<p>The string must be a valid logical path.</p> <p>Copies an existing file to a new file or an existing directory to a new directory.</p> <p>Two forms of parameters are allowed. The first form has two parameters. In this form, the first parameter specifies the source, and the second parameter specifies the destination.</p> <p>The second form has four parameters. In this form, the first and third parameters specify the source. The second and fourth parameters specify the directories. The first pair of parameters specifies the source. The second pair specifies the destination. An error is generated if the source doesn't exist or the destination file already exists.</p> <p>This command will generate an "access denied" error if the destination is a restricted folder (e.g., C:\Windows) and the current user does not have Power User or Administrator privileges.</p>

Mass Storage Device Copy (Remote Command Only)

This command transfers data to/from a file and a peripheral device.

Key path	SCPI Only
Remote Command	:MMEMory:COPY:DEvice <source_string>,<dest_string>
Notes	<p>The strings must be a valid logical path or a valid device keyword. If the dest_string is a device keyword, the data is copied from the source file to the device. If the source_string is a device keyword, the data is copied to the source file from the device.</p> <p>Valid device keywords are:</p> <p>SNS (smart noise source)</p> <p>An error is generated if the file or device is not found.</p>

Mass Storage Delete (Remote Command Only)

Key path	SCPI Only
Remote Command	:MMEMory:DELeTe <file_name>[,<directory_name>]
Notes	The string must be a valid logical path. Removes a file from the specified directory. The <file_name> parameter specifies the file name to be removed. This command will generate an "access denied" error if the file is in a restricted folder (e.g., C:\Windows) and the current user does not have Power User or Administrator privileges.
Initial S/W Revision	Prior to A.02.00

Mass Storage Data (Remote Command Only)

Creates a file containing the specified data OR queries the data from an existing file.

Key path	SCPI Only
Remote Command	:MMEMory:DATA <file_name>, <data> :MMEMory:DATA? <file_name>
Notes	The string must be a valid logical path. The command form is MMEMory:DATA <file_name>,<data>. It loads <data> into the file <file_name>. <data> is in 488.2 block format. <file_name> is string data. The query form is MMEMory:DATA? <file_name> with the response being the associated <data> in block format.
Initial S/W Revision	Prior to A.02.00

Mass Storage Make Directory (Remote Command Only)

Key path	SCPI Only
Remote Command	:MMEMory:MDIRectory <directory_name>
Notes	The string must be a valid logical path. Creates a new directory. The <directory_name> parameter specifies the name to be created. This command will generate an "access denied" error if the new directory would be in a restricted folder (e.g., C:\Windows) and the current user does not have Power User or Administrator privileges.
Initial S/W Revision	Prior to A.02.00

Mass Storage Move (Remote Command Only)

Key path	SCPI Only
Remote Command	:MMEMory:MOVE <string>,<string>[,<string>,<string>]
Notes	The string must be a valid logical path. Moves an existing file to a new file or an existing directory to a new directory.

Two forms of parameters are allowed. The first form has two parameters. In this form, the first parameter specifies the source, and the second parameter specifies the destination.

The second form has four parameters. In this form, the first and third parameters specify the source. The second and fourth parameters specify the directories. The first pair of parameters specifies the source. The second pair specifies the destination. An error is generated if the source doesn't exist or the destination file already exists.

This command will generate an "access denied" error if the destination is a restricted folder (e.g., C:\Windows) and the current user does not have Power User or Administrator privileges.

Initial S/W Revision Prior to A.02.00

Mass Storage Remove Directory (Remote Command Only)

Key path SCPI Only

Remote Command :MMEMory:RDIRECTory <directory_name>

Notes The string must be a valid logical path.

Removes a directory. The <directory_name> parameter specifies the directory name to be removed. All files and directories under the specified directory shall also be removed.

This command will generate an "access denied" error if the folder is a restricted folder (e.g., C:\Windows) or is in a restricted folder and the current user does not have Power User or Administrator privileges.

Initial S/W Revision Prior to A.02.00

Mass Storage Determine Removable Media (Remote Command Only)

This command is used to determine if any removable media devices are connected to the instrument. Primarily, these are USB memory devices plugged-in to the front panel or rear panel USB ports. On instruments with PC6 or PC7 CPU's, one SD card slot is available for removable media. The instrument's primary disk drive is not a removable media device.

Key Path SCPI Only

Remote Command :MMEMory:RMEDIA:LIST?

Notes The return value will be a string containing a list of partition identifiers which are removable media devices. Each identifier will be separated by a comma. If no removable media is present, an empty string will be returned.

Examples:

One removable device present will result in a return string of "F:".

Two removable devices present will result in a return string of "F:,G:".

No removable devices present will result in a return string of "".

Initial S/W Revision x.15.00

Mass Storage Determine Removable Media Label (Remote Command Only)

This command is used to set or query a removable media device's label.

Key Path	SCPI Only
Remote Command	:MMEMory:RMEDia:LABel <partition>,<string> :MMEMory:RMEDia:LABel? <partition>
Example	MMEM:RMED:LAB "F:","My Device"
Notes	If the <partition> specified does not exist or is not a removable media device the error -252,"Missing Media" will be generated. Setting the removable media label requires Administrative privileges. If the currently logged in user does not have appropriate privileges the error "-221.9900,Settings conflict;Administrator privileges required" is generated.
Initial S/W Revision	x.15.00

Mass Storage Determine Removable Media Write-protect status (Remote Command Only)

This command is used to query a removable media device's write-protect status.

Key Path	SCPI Only
Remote Command	:MMEMory:RMEDia:WPRotect? <partition>
Example	MMEM:RMED:WPR? "F:"
Notes	The return value is 1 if the device is write-protected, and 0 if the device is write-enabled. If the <partition> specified does not exist or is not a removable media device the error -252,"Missing Media" will be generated.
Preset	The return value will be depending on SD card installed.
Initial S/W Revision	x.15.00

Mass Storage Determine Removable Media size (Remote Command Only)

This command is used to query a removable media device's total memory size (not available memory size).

Key Path	SCPI Only
Remote Command	:MMEMory:RMEDia:SIZE? <partition>
Example	MMEM:RMED:SIZE? "F:"
Notes	The return value is integer value in GBytes. Any device which is less than 1 GB will return 0 GB. If the <partition> specified does not exist or is not a removable media device the error -252,"Missing Media" will be generated.
Initial S/W Revision	x.15.00

Sequences

These keys allow you to save a Tab separated or CSV file of the setup parameters required to build a Sequence.

In order to save you must select the Save As button and choose a destination folder.

Key Path	Save, Sequences
Mode	All
Remote Command	:MMEM:STOR:SEquences: SLIST ALIST SAAList SStep "MySequence.txt"
Example	:MMEM:STOR:SEQ:SLIST "MySequence.txt"
Notes	Available file types are: –CSV (Comma delimited) (*.csv) –Text (Tab delimited) (*.txt)
Initial S/W Revision	A.05.00

Source Sequence

The list of parameters, that configure steps, that makes up a sequence for the Source.

The Source sequence is a sequence of flexible configurable steps that can be set anywhere in the instruments frequency range.

Key Path	Save, Sequences
Example	:MMEM:STOR:SEQ:SLIS "MySequence.txt"
Dependencies	Only available in XOBT
Initial S/W Revision	A.05.00

Save As . . .

This menu lets you select the location where you can save the Sequence. This menu is a standard Windows® dialog with Save As menu keys. The "File Name" field in the Save As dialog is initially loaded with an automatically generated filename specific to the appropriate Save Type. The automatically generated filename is guaranteed not to conflict with any filename currently in the directory. You may replace or modify this filename using the File Name softkey. See the Quick Save key documentation for more on the automatic file naming algorithm.

The default path for all Sequence Files is:

My Documents\Sequences

Key Path	Save, Sequences
Mode	All

Notes	Brings up Save As dialog for saving a Sequence Save Type
Initial S/W Revision	A.05.00

Data (Export)

Exporting a data file stores data from the current measurement to mass storage files. The Export Menu only contains data types that are supported by the current measurement.

Since the commonly exported data files are in .csv format, the data can be edited by you prior to importing. This allows you to export a data file, manipulate the data in Excel (the most common PC Application for manipulating .csv files) and then import it.

Selecting an Export Data menu key will not actually cause the exporting to occur, since the analyzer still needs to know where you wish to save the data. Pressing the Save As key in this menu brings up the Save As dialog and Save As menu that allows you to specify the destination file and directory. Once a filename has been selected or entered in the Open menu, the export will occur as soon as the Save key is pressed.

Key Path	Save
Mode	All
Notes	The menu is built from whatever data types are available for the mode. So the key locations in the sub menu will vary. No SCPI command directly controls the Data Type that this key controls. The Data Type is included in the MMEM:STORe commands.
Dependencies	If a file type is not used by a certain measurement, that type is grayed out for that measurement. The key for a file type will not show at all if there are no measurements in the Mode that support it.
Preset	Is not affected by a Preset or shutdown, but is reset during Restore Mode Defaults
Readback	The data type that is currently selected
Initial S/W Revision	Prior to A.02.00

Measurement Results

Pressing this key selects Meas Results as the data type to be exported. Pressing the key a second time brings up the Meas Results menu, which allows you to select which **Meas Result** to save. In the Swept SA measurement, there are three types of Measurement Results files: Peak Table, Marker Table and Spectrogram.

See ["Meas Results File Contents" on page 2081](#).

See ["Marker Table" on page 2081](#).

See ["Peak Table" on page 2084](#).

See ["Spectrogram" on page 2087](#)

Remote Command	:MMEMory:STORe:RESults:MTABle PTABle SPECTrogram <filename>
-----------------------	---

Example	<p>:MMEM:STOR:RES:MTAB "myResults.csv" Saves the results from the current marker table to the file myResults.csv in the current path.</p> <p>:MMEM:STOR:RES:PTAB "myResults.csv" Saves the results from the current peak table to the file myResults.csv in the current path.</p> <p>:MMEM:STOR:RES:SPEC "myResults.csv" Saves the results from the current Spectrogram display to the file myResults.csv in the current path.</p> <p>The default path is My Documents\SA\data\SAN\results</p>
Notes	<p>If the save is initiated via SCPI, and the file already exists, the file will be overwritten.</p> <p>Using the C: drive is strongly discouraged, since it runs the risk of being overwritten during an instrument software upgrade.</p> <p>Both single and double quotes are supported for any filename parameter over SCPI.</p>
Dependencies	<p>If a save of Marker Table results is requested and the Marker Table is not on, no file is saved and a message is generated</p> <p>If a save of Peak Table results is requested and the Peak Table is not on, no file is saved and a message is generated</p> <p>If a save of Spectrogram results is requested and the Spectrogram is not on, no file is saved and a message is generated.</p> <p>The Spectrogram choice only appears if option EDP is licensed.</p>
Preset	Not part of Preset, but is reset to Peak Table by Restore Mode Defaults. Survives a shutdown.
Initial S/W Revision	Prior to A.02.00

Meas Results File Contents

All files are .csv files. The following section details the data in each file type.

Marker Table

This section discusses the Marker Table Meas Results file format.

Imagine that, at the point where a Marker Table Meas Result is requested, the following screen is showing:

14 QPSK EVM Measurement
Save

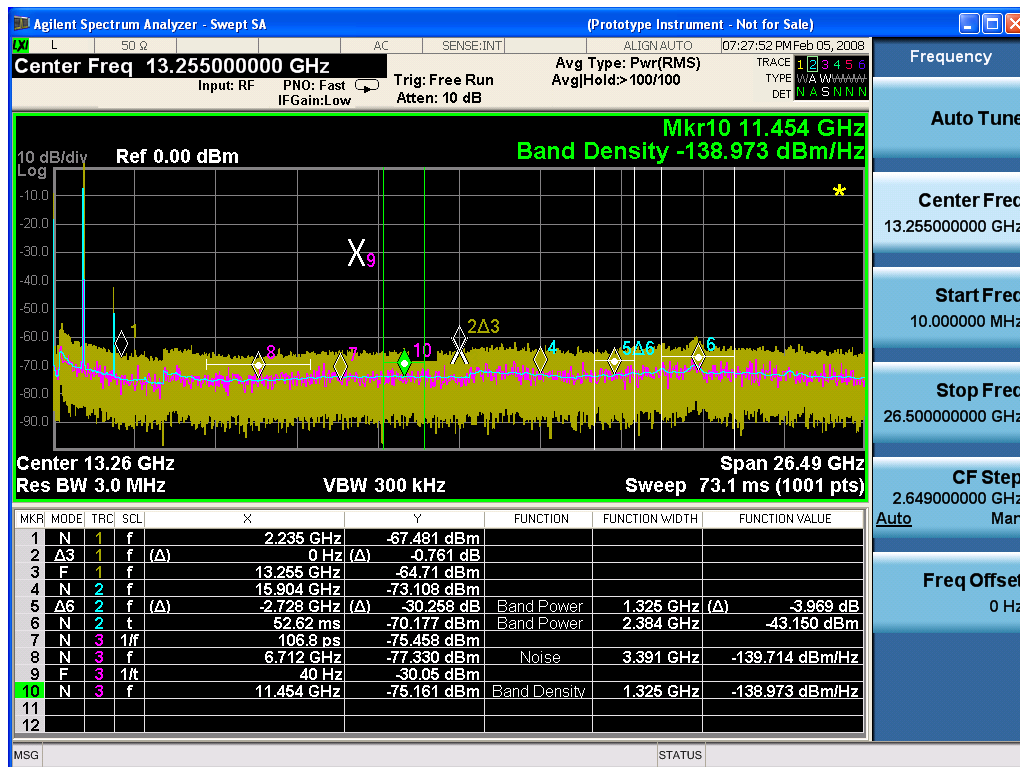

Then the Meas Results file, when opened, would show the following data:

MeasurementR	
result	
Swept SA	
A.01.40_R0017	N9020A
526 B25 PFR	1
P26 EA3	
Result Type	Marker Table
Ref Level	0
Number of Points	1001
Sweep Time	0.0662666 67
Start Frequency	10000000
Stop Frequency	26500000 000
Average Count	0
Average Type	LogPower (Video)
RBW	3000000

RBW Filter	Gaussian
RBW Filter BW	3dB
VBW	3000000
Sweep Type	Swept
X Axis Scale	Lin
PreAmp State	Off
PreAmp Band	Low
Trigger Source	Free
Trigger Level	1.2
Trigger Slope	Positive
Trigger Delay	1.00E-06
Phase Noise Optimization	Fast
Swept If Gain	Low
FFT If Gain	Autorange
RF Coupling	AC
FFT Width	411900
Ext Ref	10000000
Input	RF
RF Calibrator	Off
Attenuation	10
Ref Level Offset	0
External Gain	0
X Axis Units	Hz
Y Axis Units	dBm

DATA									
MKR	MODE	TR C	SCL	X	Y	FUNCTI ON	FUNCTIO N WIDTH	FUNCTI ON VALUE	FUNCTI ON UNIT
1	Normal	1	Freque ncy	2.2350E+09	- 67.481	Off	0.0000E+00	0	None
2	Delta3	1	Freque ncy	0.0000E+00	- 0.761	Off	0.0000E+00	0	None
3	Fixed	1	Freque ncy	1.3255E+10	- 64.71	Off	0.0000E+00	0	None
4	Normal	2	Freque ncy	1.5904E+10	- 73.1	Off	0.0000E+00	0	None

08									
5	Delta7	2	Frequency	-2.7280E+09	-30.258	Band Power	1.3250E+06	-3.969	dB
6	Normal	2	Time	5.2620E-02	-70.177	Band Power	2.3840E+06	-43.15	dBm
7	Normal	3	Period	1.0680E-10	-75.458	Off	0.0000E+00	0	None
8	Normal	3	Frequency	6.7120E+09	-77.33	Noise	3.3910E+06	-139.714	dBm/Hz
9	Fixed	3	Inverse Time	4.0000E+01	-30.05	Off	0.0000E+00	0	None
10	Normal	3	Frequency	1.1454E+10	-75.161	Band Density	1.3250E+06	-138.973	dBm/Hz
11	Off	1	Frequency	0.0000E+00	0	Off	0.0000E+00	0	None
12	Off	1	Frequency	0.0000E+00	0	Off	0.0000E+00	0	None

The numbers appear in the file exactly as they appear onscreen. If it says 11.454 GHz onscreen, then in the file it is 11.454E+09.

The metadata header is very similar to the metadata used in the trace data .csv files. See Trace File Contents. The only new information concerns the 1-of-N fields in the marker table itself.

Peak Table

This section discusses the Peak Table Meas Results file format.

Imagine that, at the point where a Marker Table Meas Result is requested, the following screen is showing:

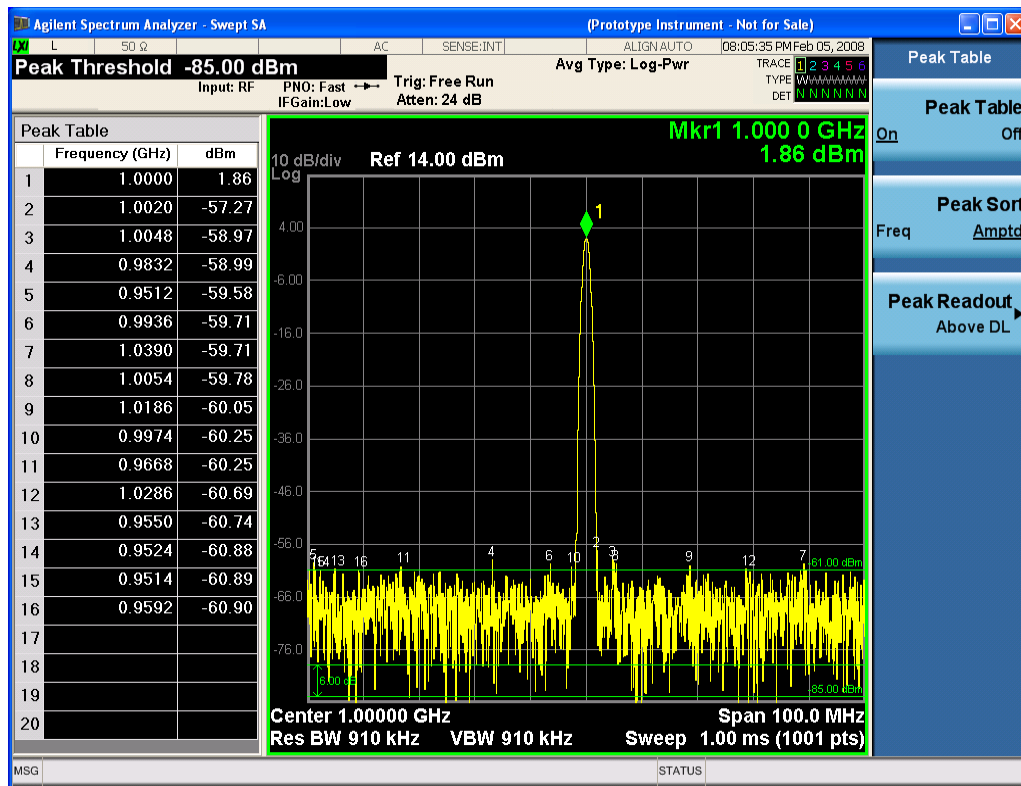

Then the Meas Results file, when opened, would show the header data (the same as for the Marker Table except that the Result Type is Peak Table) ending with a few fields of specific interest to Peak Table users:

- Peak Threshold
- Peak Threshold State (On|Off)
- Peak Excursion
- Peak Excursion State (On|Off)
- Display Line
- Peak Readout (All|AboveDL|BelowDL)
- Peak Sort (Freq|Amptd)

These fields are then followed by the data for the Peak Table itself.

Note that the label for the Frequency column changes to Time in 0 span.

Here is what the table for the above display looks like:

MeasurementResult	
Swept SA	
A.01.40_R0017	N9020A
526 B25 PFR P26 EA3	1

Result Type	Peak Table
Ref Level	0
Number of Points	1001
Sweep Time	0.066266667
Start Frequency	10000000
Stop Frequency	26500000000
Average Count	0
Average Type	LogPower(Video)
RBW	3000000
RBW Filter	Gaussian
RBW Filter BW	3dB
VBW	3000000
Sweep Type	Swept
X Axis Scale	Lin
PreAmp State	Off
PreAmp Band	Low
Trigger Source	Free
Trigger Level	1.2
Trigger Slope	Positive
Trigger Delay	1.00E-06
Phase Noise Optimization	Fast
Swept If Gain	Low
FFT If Gain	Autorange
RF Coupling	AC
FFT Width	411900
Ext Ref	10000000
Input	RF
RF Calibrator	Off
Attenuation	10
Ref Level Offset	0
External Gain	0
X Axis Units	Hz
Y Axis Units	dBm
Peak Threshold	-85
Peak Threshold State	On
Peak Excursion	6
Peak Excursion State	On

Display Line	-61	
Peak Readout	AboveDL	
Peak Sort	Amptd	
DATA		
Peak	Frequency	Amplitude
1	1.0000E+06	1.86
2	1.0020E+06	-57.27
3	1.0048E+06	-58.97
4	9.8320E+05	-58.99
5	9.5120E+05	-59.58
6	9.9360E+05	-59.71
7	1.0390E+06	-59.71
8	1.0054E+06	-59.78
9	1.1086E+06	-60.05
10	9.9740E+05	-60.25
11	9.6680E+05	-60.25
12	1.0286E+06	-60.69
13	9.5500E+05	-60.74
14	9.5240E+05	-60.88
15	9.5140E+05	-60.89
16	9.5920E+05	-60.90
17		
18		
19		
20		

Spectrogram

This section discusses the Spectrogram Results file format. The Spectrogram choice only appears if option EDP is licensed.

The Spectrogram results are the same as a Trace data export, except that instead of having just one trace's data, all 300 traces appear one after the other.

Each trace has its own data mark; the data for Spectrogram Trace 0 follows the row marked DATA, the data for Spectrogram Trace 1 follows the row marked DATA1, for Spectrogram Trace 2 follows the row marked DATA2, and so on.

Each DATA row has a timestamp in the second column (as of firmware revision A.11.01). So, for example, if Trace 0 had a relative start time of 1729.523 sec, then the first DATA row would look like this:

DATA,1729.523

And if Trace 13 had a relative start time of 100.45 sec, then the fourteenth data row would look like:

DATA13,100.453

To find the absolute time for the relative timestamps of each trace, the last row before the first DATA row gives the absolute start time of the Spectrogram, in the form YYYYMMDDHHMMSS

So, for example, if the absolute start time is 13:23:45:678 on January 30, 2012, this row would look like:

Start Time,20120130132345678

NOTE:

NOTE The resolution of the absolute time stored is 1 ms, which matches up with the fact that the fastest sweep time is also 1 ms. However, there is no specification for the absolute accuracy of the clock in the analyzer, nor is there any facility provided to allow the user to set this time to any particular degree of accuracy.

Traces that have not yet been filled in the Spectrogram display are empty; there is no DATA header for them. The file ends after the last non-empty trace.

Imagine that, at the point where a Spectrogram Meas Result is requested, the following screen is showing:



For the purpose of this example, we have set the Average/Hold Number to 10, thus we have only traces 0 thru 10. The Spectrogram was started at 02:28:08:700 pm on April 25, 2012 (that is, 700 ms after 2:28:08 pm), although the screen dump itself shows a different time, as it was taken ten minutes after the Spectrogram data. Trace 0 is showing a start time of 5.30 seconds, meaning 5.3 seconds after the Spectrogram started (trace 10 has a start time of 0, as it was the first trace taken but has now rolled up into the tenth trace slot).

The Meas Results file, when opened, shows the header data and ten traces of trace data. Below is an extract from the result file for the above display. Note the start time of 20120425142808700 showing in the last row before the first DATA row, and the relative time of 5.299231048 showing in the first DATA row:

Result Type	Spectrogram
MeasResult	
Swept SA	
A.11.00.01	N9020A
F03 F07 F13 F26 ALL ALV B1C B1X B25 B2X B40 BAB BBA CR3 CRP DP2 DRD EA3 EDP EMC EP1 ERC ESC ESP EXM FSA HBA K03 LFE MPB P03 P08 P13 P26 PFR RTL RTS S40 SB1 SEC SM1 UK6 YAS YAV	1
Segment	0
Number of Points	1001
Sweep Time	0.523333333
Start Frequency	5999984415
Stop Frequency	6000009415
Average Count	0
Average Type	LogPower(Video)
RBW	240
RBW Filter	Gaussian
RBW Filter BW	3dB
VBW	240
Sweep Type	Swept
X Axis Scale	Lin
PreAmp State	Off
PreAmp Band	Low
Trigger Source	Free
Trigger Level	1.2
Trigger Slope	Positive
Trigger Delay	0
Phase Noise Optimization	Wide
Swept If Gain	Low

Result Type	Spectrogram
FFT If Gain	Autorange
RF Coupling	AC
FFT Width	411900
Ext Ref	10000000
Input	RF
RF Calibrator	Off
Attenuation	14
Ref Level Offset	0
External Gain	0
Trace Type	Clearwrite
Detector	Normal
Trace Math	Off
Trace Math Oper1	Trace5
Trace Math Oper2	Trace6
Trace Math Offset	0
Trace Name	Trace1
X Axis Units	Hz
Y Axis Units	dBm
Start Time	20120425142808700
DATA	5.299231048
5999984415	-76.34749519
5999984440	-77.28097006
5999984465	-75.32317869
5999984490	-73.64417681
5999984515	-72.67154604

O

O

O

6000009315	-77.94423277
6000009340	-79.51829697
6000009365	-78.46108961
6000009390	-78.46108957
6000009415	-76.59570596
DATA2	4.708697055

5999984415	-80.98197882
5999984440	-80.98197879
5999984465	-75.83142132
5999984490	-74.02712079
5999984515	-73.57213005

-
-
-

6000009315	-75.9183103
6000009340	-79.53787488
6000009365	-78.82602191
6000009390	-78.82602188
6000009415	-76.37486709
DATA10	0
5999984415	-75.56751112
5999984440	-75.76485645
5999984465	-76.67718717
5999984490	-78.79238489
5999984515	-83.72680212

-
-
-

6000009315	-71.3942461
6000009340	-72.28308332
6000009365	-73.92684489
6000009390	-75.45548832
6000009415	-75.17904815

Capture Buffer

This function allows you to store captured data for reuse in demod measurements using 'Save/Recall' functionality for 'Capture Buffer'. (This function is enabled for 'Code Domain' and 'Modulation Accuracy' measurements ONLY)

'Capture Buffer' is saved and loaded as IQ Data with properties which show Sample Rate, Length, IF BW, etc.

Use-Case are as followings;

Use Capture Buffer to perform analysis of the same captured data using 'Code Domain' and 'Modulation Accuracy' measurements, or to playback previously saved captured data.

Key Path	Save, Data
Mode	CDMA2000
Example	MMEM:STOR:CAPT "MyCaptureData.bin" This stores the capture data in the file MyCaptureData.bin in the default directory.
Dependencies	Capture buffer functionality is only available for Code Domain and Modulation Accuracy measurement. In other measurements, this key is grayed out.
Initial S/W Revision	Prior to A.02.00

Save As . . .

When you press "Save As", the analyzer brings up a Windows dialog and a menu entitled "**Save As.**" This menu allows you to navigate to the various fields in the Windows dialog without using a keyboard or mouse. The Tab and Arrow keys can also be used for dialog navigation.

See "[To File . . .](#)" on page 2070 in Save, State for a full description of this dialog and menu.

The default path for saving files is:

For all of the Trace Data Files:

My Documents\<<mode name>\data\traces

For all of the Limit Data Files:

My Documents\<<mode name>\data\limits

For all of the Measurement Results Data Files:

My Documents\<<mode name>\data\<<measurement name>\results

For all of the Capture Buffer Data Files:

My Documents\<<mode name>\data\captureBuffer

Key Path	Save, Data
Mode	All
Notes	The key location is mode-dependent and will vary. Brings up the Save As dialog for saving a <mode specific> Save Type. The save is performed immediately and does not wait until the measurement is complete.
Initial S/W Revision	Prior to A.02.00

Screen Image

Pressing Screen Image accesses a menu of functions that enable you to specify a format and location for the saved screen image. It brings up a menu that allows you to specify the color scheme of the Screen Image (Themes) or navigate to the Save As dialog to perform the actual save.

Screen Image files contain an exact representation of the analyzer display. They cannot be loaded back onto the analyzer, but they can be loaded into your PC for use in many popular applications.

The image to be saved is actually captured when the Save front panel key is pressed, and kept in temporary storage to be used if you ask for a Screen Image save. When the Screen Image key is pressed, a "thumbnail" of the captured image is displayed, as shown below:

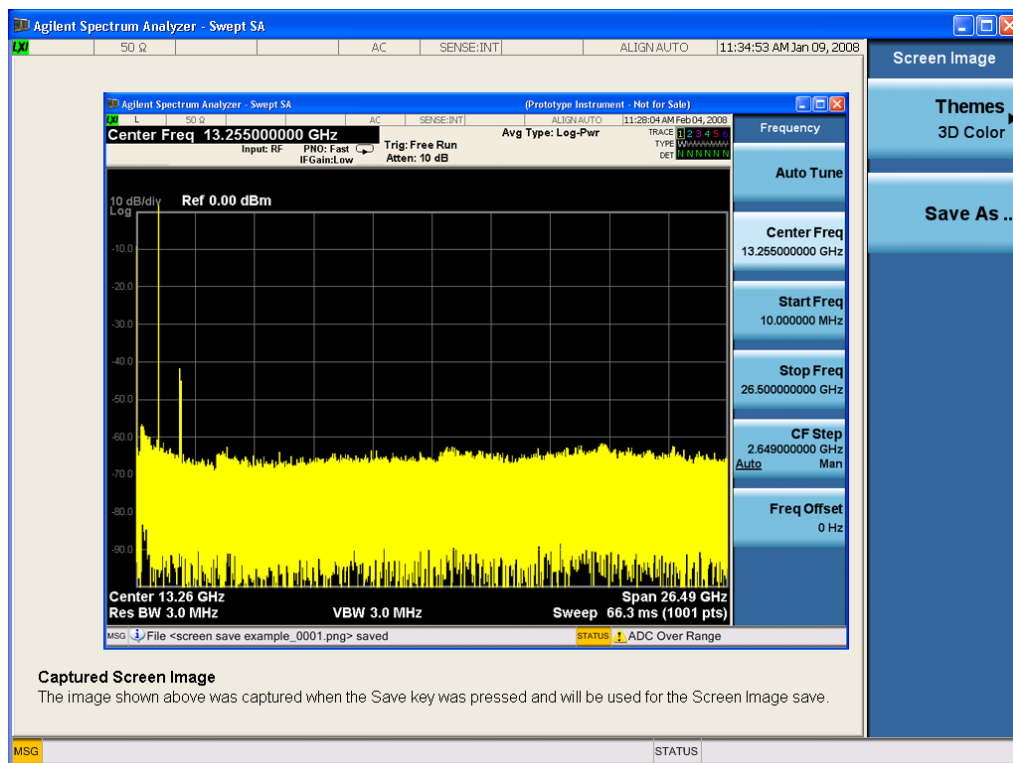

When you continue on into the Save As menu and complete the Screen Image save, the image depicted in the thumbnail is the one that gets saved, showing the menus that were on the screen before going into the Save menu. The save is performed immediately and does not wait until the measurement is complete.

After you have completed the save, the Quick Save front-panel key lets you quickly repeat the last save performed, using an auto-named file, with the current screen data.

NOTE

For versions previous to A.01.55, if you initiate a screen image save by navigating through the Save menus, the image that is saved will contain the Save menu softkeys, not the menu and the active function that were on the screen when you first pressed the Save front panel key.

Key Path	Save
Mode	All

Remote Command	:MMEMory:STORe:SCReen <filename>
Example	:MMEM:STOR:SCR "myScreen.png" This stores the current screen image in the file MyScreenFile.png in the default directory.
Initial S/W Revision	Prior to A.02.00

Themes

Accesses a menu of functions that enable you to choose the theme to be used when saving the screen image.

The **Themes** option is the same as the **Themes** option under the **Display** and **Page Setup** dialogs. It allows you to choose between themes to be used when saving the screen image.

Key Path	Save, Screen Image
Remote Command	:MMEMory:STORe:SCReen:THEMe TDColor TDMonochrome FCOLor FMONochrome :MMEMory:STORe:SCReen:THEMe?
Example	:MMEM:STOR:SCR:THEM TDM
Preset	3D Color; Is not part of Preset, but is reset by Restore Misc Defaults or Restore System Defaults All and survives subsequent running of the modes.
Readback	3D Color 3D Mono Flat Color Flat Mono
Backwards Compatibility Notes	In ESA and PSA we offer the choice of "Reverse Bitmap" or "Reverse Metafile" when saving screen images. This is much like the "Flat Color" theme available in X-Series. Also, if you selected Reverse Bitmap AND a black & white screen image, that would be much like "Flat Monochrome". In other words, each of the X-Series themes has a similar screen image type in ESA/PSA. But they are not identical.
Initial S/W Revision	Prior to A.02.00

3D Color

Selects a standard color theme with each object filled, shaded and colored as designed.

Key Path	Save, Screen Image, Themes
Example	MMEM:STOR:SCR:THEM TDC
Readback	3D Color
Initial S/W Revision	Prior to A.02.00

3D Monochrome

Selects a format that is like 3D color but shades of gray are used instead of colors.

Key Path	Save, Screen Image, Themes
Example	MMEM:STOR:SCR:THEM TDM
Readback	3D Mono
Initial S/W Revision	Prior to A.02.00

Flat Color

Selects a format that is best when the screen is to be printed on an ink printer.

Key Path	Save, Screen Image, Themes
Example	MMEM:STOR:SCR:THEM FCOL
Readback	Flat Color
Initial S/W Revision	Prior to A.02.00

Flat Monochrome

Selects a format that is like Flat Color. But only black is used (no colors, not even gray), and no fill.

Key Path	Save, Screen Image, Themes
Example	MMEM:STOR:SCR:THEM FMON
Readback	Flat Mono
Initial S/W Revision	Prior to A.02.00

Save As...

When you press "Save As", the analyzer brings up a Windows dialog and a menu entitled "**Save As.**" This menu allows you to navigate to the various fields in the Windows dialog without using a keyboard or mouse. The Tab and Arrow keys can also be used for dialog navigation.

See "[To File . . .](#)" on page 2070 in Save, State for a full description of this dialog and menu.

The default path for Screen Images is

My Documents\`<mode name>`\screen.

where `<mode name>` is the parameter used to select the mode with the INST:SEL command (for example, SA for the Spectrum Analyzer).

Key Path	Save, Screen Image
Notes	Brings up Save As dialog for saving a Screen Image Save Type
Initial S/W Revision	Prior to A.02.00

Single (Single Measurement/Sweep)

Sets the analyzer for Single measurement operation. The single/continuous state is Meas Global, so the setting will affect all the measurements. If you are Paused, pressing Single does a Resume.

See "[More Information](#)" on page 2096

Key Path	Front-panel key
Example	:INIT:CONT OFF
Notes	See Cont key description.
Backwards Compatibility Notes	<p>For Spectrum Analysis mode in ESA and PSA, the Single hardkey and the INITiate:IMM switched from continuous measurement to single measurement and restarted sweeps and averages (displayed average count reset to 1), but did not restart Max Hold and Min Hold. In the X-Series, the Single hardkey and the INITiate:IMM command initiate a sweep/ measurement/ average sequence/hold sequence including MaxHold and MinHold.</p> <p>For Spectrum Analysis mode in ESA and PSA, the Single hardkey restarted the sweep regardless of whether or not you were in an active sweep or sweep sequence. In the X-Series, Restart does this but Single only restarts the sweep or sweep sequence if you are in the idle state.</p> <p>INIT[:IMM] in ESA & PSA Spectrum Analysis Mode does an implied ABORT. In some other PSA Modes, INIT[:IMM] is ignored if not in the idle state. . The X-Series follows the ESA/PSA SA Mode model, which may cause some Modes to have compatibility problems.</p>
Initial S/W Revision	Prior to A.02.00

More Information

See "[Restart](#)" on page 2067 for details on the INIT:IMMEDIATE (Restart) function.

If you are already in single sweep, the INIT:CONT OFF command has no effect.

If you are already in Single Sweep, then pressing the Single key in the middle of a sweep does not restart the sweep or sequence. Similarly, pressing the Single key does not restart the sweep or sequence if the sweep is not in the idle state (for example, if you are taking a very slow sweep, or the analyzer is waiting for a trigger). Instead, it results in a message. "Already in Single, press Restart to initiate a new sweep or sequence". Even though pressing the Single key in the middle of a sweep does not restart the sweep, sending INIT:IMMEDIATE does reset it.

To take one more sweep without resetting the average count, increment the average count by 1, by pressing the step up key while **Average/Hold Number** is the active function, or sending the remote command CALC:AVER:TCON UP.

Source

Opens a menu of keys that access various source configuration menus and settings. In the test set, pressing this key also causes the central view area to change and display the Source Control Main view.

Key Path	Front-panel key
----------	-----------------

RF Output

This parameter sets the source RF power output state.

Key Path	Source
Remote Command	:OUTPut[:EXTernal][:STATe] ON OFF 1 0 :OUTPut[:EXTernal][:STATe]?
Example	OUTP OFF OUTP?
Notes	<p>The EXTERNAL node is shown in RD text so the SCPI remains the same between internal and external source control. However, for EXT we do not wish to document this node to the customer since we are controlling the internal source rather than the external source.</p> <p>This setting is for the independent mode and has no effect on the "List Sequencer" on page 2168. If the "Sequencer" on page 2168 is set to ON, the list sequencer controls the source output and this key will be grayed-out. And this setting will be none-forceful grey out on front panel to indicate out-of-scope. Non-forceful means user still can change this setting by SCPI but cannot change on front panel. When set to OFF will make source leave list sequencer and this setting will be black out and take effect immediately.</p> <p>When the RF Output is ON, an "RF" annunciator is displayed in the system settings panel. When the RF Output is turned Off, the RF annunciator is cleared. If the "Sequencer" on page 2168 is set to ON, the "RF" annunciator will be replaced by "SEQ" in the system settings panel, indicating that the output is controlled by the list sequencer.</p>
Preset	Off
Range	On Off
Initial S/W Revision	A.05.00

Amplitude

Allows you to access the Amplitude sub-menu.

Key Path	Source
Notes	<p>The sub-menu under this button is for independent mode and has no effect on "List Sequencer" on page 2168. If the "Sequencer" on page 2168 is set to ON, the list sequencer controls the source output and this key will be grayed-out on front panel to indicate out-of-scope. When you set "Sequencer" on page 2168 to Off will make source leave list sequencer and this button will be black out.</p>
Initial S/W Revision	A.05.00

RF Power

Allows you to adjust the power level of the source using the numeric keypad, step keys, or RPG. Pressing any digit, 0 through 9, on the numeric keypad brings up the unit terminator.

Please refer to the "[RF Power Range](#) " on page 2099 table below for the valid ranges.

Key Path	Source, Amplitude
Remote Command	:SOURce:POWer[:LEVel][:IMMediate][:AMPLitude] <ampl> :SOURce:POWer[:LEVel][:IMMediate][:AMPLitude]?
Example	:SOUR:POW -100 dBm
Notes	<p>Amplitude corrections can be specified for use with the source. In the event of amplitude corrections being applied, the valid ranges for the RF power do not change dependant on the current amplitude correction setting. If the combination of RF power + amplitude correction is higher or lower than the source output range, the Source Unleveled bit is set and the "Source Unleveled" indicator will appear on status panel to indicate that the source cannot maintain the output power that has been requested.</p> <p>When signal generator is unable to maintain the requested output level, the "Source Unleveled" indicator will appear on status panel. When the source output setting is restored to the normal range, the "Source Unleveled" is removed from status panel.</p> <p>Internal source has list sequence mode, which comprises of several steps which contain separate output power, frequency and waveform etc. When the source list sequence playing is complete, the last step keeps playing, and user can use this command to change the list sequence last step's output power.</p> <p>The multiport adapter RFIO TX ports and GPS ports cannot ensure power accuracy when power setting is lower than -130dBm, this power setting value is defined by the sum of RF Power setting and related amplitude correction value. But user settable value could be lower than this limit. When application detected there exists power setting lower than -130dBm on MPA RFIO TX ports, then popup warning message . When application detected there exists power setting lower than -130dBm on MPA GPS ports, then popup warning message . This is only warning message, and check is performed when RF is ON.</p>
Notes	The Min and Max value here defined UI settable amplitude range. This range is larger than actual amplitude range with level accuracy defined in spec.
Dependencies	The RF power is dependent on the RF output port and frequency, such that the current frequency and selected output port determine the valid range of power values.
Preset	-100 dBm
Min	The range of values depends on the current frequency and selected RF output port. Please refer to the " RF Power Range " on page 2099 table below for the valid ranges.
Max	The range of values depends on the current frequency and selected RF output port. Please refer to the " RF Power Range " on page 2099 table below for the valid ranges.
Initial S/W Revision	A.05.00

All other models:

RF Power Range

RF Output Port	Frequency Range	Min Output Power	Max Output Power
High Power RF Out	10 MHz \leq f \leq 6 GHz	-150 dBm	20 dBm
RFIO 1 & RFIO 2	10 MHz \leq f \leq 6 GHz	-150 dBm	0 dBm
GPS (Note2)	10 MHz \leq f \leq 6 GHz	-150 dBm	0 dBm

Note: This is the UI power range, it's larger than actual spec.

Note2: GPS port is on the multiport adapter, or E6607C which has embedded MPA.

M9420A:

RF Power Range

RF Output Port	Frequency Range	Min Output Power	Max Output Power without Option "1EA"	Max Output Power with Option "1EA"
RF Output	60 MHz \leq f \leq 6 GHz	-150 dBm	10 dBm	18 dBm
RFHD	60 MHz \leq f \leq 6 GHz	-150 dBm	10 dBm	15 dBm
RFFD	60 MHz \leq f \leq 6 GHz	-150 dBm	0 dBm	0 dBm

Set Reference Power

This key allows you to set the power reference. Pressing this key turns the power reference state to ON, sets the reference power value to the current RF output power, maintains this power at the RF output, and sets the displayed power to 0.00 dB. All subsequent RF power values entered under Source>Amplitude>RF Power are interpreted as being relative to this reference power.

When you use a power reference, the signal generator outputs an RF power that is set relative to the reference power by the value entered under Source>Amplitude>RF Power as follows:

Output power = reference power – entered power

Where:

reference power equals the original RF Power entered under Source>Amplitude>RF Power and set as the reference power

entered power equals a new value entered under Source>Amplitude>Amptd Offset

In addition, the displayed power value is the same as a new value entered under Source>Amplitude>RF Power.

NOTE

If Power Ref is set to ON with a reference value set, entering a value under Source>Amplitude>RF Power and pressing Set Reference Power will add that value to the existing Power Ref value.

If you wish to change the reference power value to a new value entered under Source>Amplitude>RF Power, first you must set Power Ref to OFF and then press Set Reference Power.

Key Path	Source, Amplitude
Dependencies	This key is unavailable, and is grayed out when the "List Sequencer" on page 2168 is turned ON.
Initial S/W Revision	A.05.00

Power Ref

This key allows you to toggle the state of the power reference.

When you use a power reference, the signal generator outputs an RF power that is set relative to the reference power by the value entered under Source>Amplitude>RF Power as follows:

Output power = reference power + entered power

Where:

reference power equals the original RF Power entered under Source>Amplitude>RF Power and set as the reference power

entered power equals a new value entered under Source>Amplitude>Amptd Offset

For more information on Reference Frequency refer to ["Set Reference Power " on page 2099](#)

Key Path	Source, Amplitude
Remote Command	:SOURce:POWer:REFerence <ampl> :SOURce:POWer:REFerence? :SOURce:POWer:REFerence:STATe OFF ON 0 1 :SOURce:POWer:REFerence:STATe?
Example	:SOUR:POW:REF 0.00 dBm :SOUR:POW:REF:STATe ON
Dependencies	This setting is unavailable and is grayed out when the "List Sequencer" on page 2168 is turned ON.
Couplings	This value is coupled to the "Set Reference Power " on page 2099 key such that pressing the Set Reference Power key updates the reference power with the current output power.
Preset	0.00 dBm OFF
Min	-125.00 dBm
Max	10.00 dBm
Initial S/W Revision	A.05.00

Amptd Offset

Allows you to specify the RF output power offset value.

When the amplitude offset is set to zero (0) and you set a new offset value (positive or negative), the displayed amplitude value will change as follows and the RF output power will not change:

Displayed value = output power + offset value

Where:

output power equals the original RF Power entered under Source>Amplitude>RF Power

offset value equals the value entered under Source>Amplitude>Amptd Offset

When the amplitude offset is set to a value other than zero (0) and you enter a new RF power value under Source>Amplitude>RF Power, the displayed power will be the same as the value entered and the RF output power will be equal to the value entered minus the offset value as follows:

Output power = entered power – offset power

Displayed Power = output power + offset power

Displayed power = entered power

Where:

entered power equals the amplitude entered under Source>Amplitude>RF Power

offset power equals the value previously entered and set under Source>Amplitude>Amptd Offset

Key Path	Source, Amplitude
Remote Command	:SOURce:POWer[:LEVel][:IMMediate]:OFFSet <rel_ampl> :SOURce:POWer[:LEVel][:IMMediate]:OFFSet?
Example	:SOUR:POW:OFFS 0.00 dB
Dependencies	This setting is unavailable, and is grayed out when the List Sequencer is turned ON.
Preset	0.00 dB
Min	-200.00 dB
Max	200.00 dB
Initial S/W Revision	A.05.00

Modulation

Allows you to toggle the state of the modulation.

Key Path	Source
Remote Command	:OUTPut:MODulation[:STATe] ON OFF 1 0 :OUTPut:MODulation[:STATe]?
Example	:OUTP:MOD OFF
Notes	This setting is for independent mode and has no effect on " List Sequencer " on page 2168. If the " Sequencer " on page 2168 is set to ON, the list sequencer controls the source output and this key will be grayed-out. And this setting will be none-forceful grey out on front panel to indicate out-of-scope. Non-forceful means user still can change this setting by SCPI but cannot change manually on front panel. When set to Off will make source leave list sequencer and this setting will be black out and take effect immediately. When the Modulation is ON, the "MOD" annunciator is displayed in the system settings panel. When the Modulation is turned Off, the "MOD" annunciator is cleared. If the

	"Sequencer" on page 2168 is set to ON, the "MOD" annunciator will be replaced by "SEQ" in the system settings panel indicating that the output is controlled by list sequencer.
Preset	Off
Range	On Off
Initial S/W Revision	A.05.00

Frequency

Allows you to access the Frequency sub-menu.

Key Path	Source
Notes	The sub-menu under this button is for independent mode and has no effect on "List Sequencer" on page 2168. If the "Sequencer" on page 2168 is set to ON, the list sequencer controls the source output and this key will be grayed-out. And this button will be grey out on front panel to indicate out-of-scope. When set to Off will make source leave list sequencer and this button will be black out.
Initial S/W Revision	A.05.00

Frequency

Allows you to set the RF Output Frequency. You can adjust the frequency of the source using the numeric keypad, step keys, or RPG. Pressing any digit, 0 through 9, on the numeric keypad brings up the unit terminator.

Key Path	Source, Frequency
Remote Command	:SOURce:FREQuency[:CW] <freq> :SOURce:FREQuency[:CW]?
Example	:SOUR:FREQ 1.00 GHz
Notes	Internal source has list sequence mode, which comprises of several steps which contain separate output power, frequency and waveform etc. When the source list sequence playing is complete, the last step keeps playing, and user can use this command to change the list sequence last step's output frequency.
Couplings	The frequency value is coupled to the current channel band and number, such that updates to the band and number will update the frequency value to the corresponding absolute frequency.
Preset	1.00 GHz If license F1A or 5WC is present, the default Center Frequency should be 2.412GHz.
Min	10.00 MHz
Max	Hardware Dependant: Option 503 = 3.6 GHz Option 504 = 3.8 GHz Option 506 = 6.00 GHz For E6640A, if license 5WC is present, the frequency range should be limited to: 1.1GHz-1.7GHz,

2.4GHz–2.5GHz, 4.8GHz–6.0GHz. If the user-defined frequency is outside of range, UI will report an error message called "Settings conflict; Frequency is outside available range".

Initial S/W Revision A.05.00

Channel

The frequency of the source can be specified by a channel number of a given frequency band. This key allows you to specify the current channel number. For the appropriate range of channel numbers for a given frequency band, refer to the following tables: ["GSM/EDGE Channel Number Ranges" on page 2103](#), ["W-CDMA Channel Number Ranges" on page 2104](#), ["CDMA 2000 / 1xEVDO Channel Number Ranges" on page 2106](#), and ["LTE FDD Channel Number Ranges" on page 2108](#).

Key Path	Source, Frequency
Remote Command	:SOURce:FREQuency:CHANnels:NUMBer <int> :SOURce:FREQuency:CHANnels:NUMBer?
Example	:SOUR:FREQ:CHAN:NUMB 1
Notes	This key is grayed out when the "Radio Standard" on page 2111 is set to NONE. This key is grayed out on E6630A.
Dependencies	This key is grayed out when the "Radio Standard" on page 2111 is set to NONE. This key is grayed out on E6630A.
Couplings	The channel number is coupled to the frequency value when the "Radio Standard" on page 2111 is not set to NONE. When the frequency value is changed, the channel number will increase or decrease to match the new frequency. If the frequency is not at an exact match for a channel number, the nearest channel number is displayed along with a greater than or less than sign to indicate the frequency is above or below the channel number.
Preset	1
Min	Please refer to the tables below for the valid ranges.
Max	Please refer to the tables below for the valid ranges.
Initial S/W Revision	A.05.00

GSM/EDGE Channel Number Ranges

Band	Link (Device)	Range	Frequency (MHz)
P-GSM	Uplink (MS)	$1 \leq n \leq 124$	$890.0 + 0.2*n$
	Downlink (BS)	$1 \leq n \leq 124$	$935.0 + 0.2*n$
E-GSM	Uplink (MS)	$0 \leq n \leq 124$	$890.0 + 0.2*n$
		$975 \leq n \leq 1023$	$890.0 + 0.2*(n-1024)$
	Downlink (BS)	$0 \leq n \leq 124$	$935.0 + 0.2*n$
		$975 \leq n \leq 1023$	$935.0 + 0.2*(n-1024)$

Band	Link (Device)	Range	Frequency (MHz)
DCS 1800	Uplink (MS)	$512 \leq n \leq 885$	$1710.200 + 0.20*(n-512)$
	Downlink (BS)	$512 \leq n \leq 885$	$1805.200 + 0.20*(n-512)$
PCS 1900	Uplink (MS)	$512 \leq n \leq 810$	$1850.200 + 0.2*(n-512)$
	Downlink (BS)	$512 \leq n \leq 810$	$1930.200 + 0.2*(n-512)$
R-GSM	Uplink (MS)	$0 \leq n \leq 124$	$890.0 + 0.2*n$
		$955 \leq n \leq 1023$	$890.0 + 0.2*(n-1024)$
	Downlink (BS)	$0 \leq n \leq 124$	$935.0 + 0.2*n$
		$955 \leq n \leq 1023$	$935.0 + 0.2*(n-1024)$
GSM 450	Uplink (MS)	$256 \leq n \leq 293$	$450.6 + 0.2*(n-259)$
	Downlink (BS)	$256 \leq n \leq 293$	$460.6 + 0.2*(n-259)$
GSM 480	Uplink (MS)	$306 \leq n \leq 340$	$479.000 + 0.20*(n-306)$
	Downlink (BS)	$306 \leq n \leq 340$	$489.000 + 0.20*(n-306)$
GSM 850	Uplink (MS)	$128 \leq n \leq 251$	$824.200 + 0.20*(n-128)$
	Downlink (BS)	$128 \leq n \leq 251$	$869.200 + 0.20*(n-128)$
GSM 700	Uplink (MS)	$438 \leq n \leq 516$	$777.200 + 0.20*(n-438)$
	Downlink (BS)	$438 \leq n \leq 516$	$747.200 + 0.20*(n-438)$
T-GSM810	Uplink (MS)	$350 \leq n \leq 425$	$806.0 + 0.20*(n-350)$
	Downlink (BS)	$350 \leq n \leq 425$	$851.0 + 0.20*(n-350)$

W-CDMA Channel Number Ranges

Band	Link (Device)	Range	Frequency (MHz)
Band I	Downlink	$10562 \leq n \leq 10838$	$n \div 5$
	Uplink	$9612 \leq n \leq 9888$	$n \div 5$
Band II	Downlink	$412 \leq n \leq 687$	$n \div 5 + 1850.1$
		$9662 \leq n \leq 9938$	$n \div 5$
	Uplink	$12 \leq n \leq 287$	$n \div 5 + 1850.1$
		$350 \leq n \leq 425$	$n \div 5$
Band III	Downlink	$1162 \leq n \leq 1513$	$n \div 5 + 1575$
	Uplink	$937 \leq n \leq 1288$	$n \div 5 + 1525$
Band IV	Downlink	$537 \leq n \leq 1738$	$n \div 5 + 1805$
		$1887 \leq n \leq 2087$	$n \div 5 + 1735.1$
	Uplink	$1312 \leq n \leq 1513$	$n \div 5 + 1450$
		$1662 \leq n \leq 1862$	$n \div 5 + 1380.1$
Band V	Downlink	$1007 \leq n \leq 1087$	$n \div 5 + 670.1$
		$4357 \leq n \leq 4458$	$n \div 5$

Band	Link (Device)	Range	Frequency (MHz)
	Uplink	$782 \leq n \leq 862$	$n \div 5 + 670.1$
		$4132 \leq n \leq 4233$	$n \div 5$
Band VI	Downlink	$1037 \leq n \leq 1062$	$n \div 5 + 670.1$
		$4387 \leq n \leq 4413$	$n \div 5$
	Uplink	$812 \leq n \leq 837$	$n \div 5 + 670.1$
		$4162 \leq n \leq 4188$	$n \div 5$
Band VII	Downlink	$2237 \leq n \leq 2563$	$n \div 5 + 2175$
		$2587 \leq n \leq 2912$	$n \div 5 + 2105.1$
	Uplink	$2012 \leq n \leq 2338$	$n \div 5 + 2100$
		$2362 \leq n \leq 2687$	$n \div 5 + 2030.1$
Band VIII	Downlink	$2937 \leq n \leq 3088$	$n \div 5 + 340$
	Uplink	$2712 \leq n \leq 2863$	$n \div 5 + 340$
Band IX	Downlink	$9237 \leq n \leq 9387$	$n \div 5$
	Uplink	$8762 \leq n \leq 8912$	$n \div 5$
Band X	Downlink	$3112 \leq n \leq 3388$	$n \div 5 + 1490$
		$3412 \leq n \leq 3687$	$n \div 5 + 1430.1$
	Uplink	$2887 \leq n \leq 3163$	$n \div 5 + 1135$
		$3187 \leq n \leq 3462$	$n \div 5 + 1075.1$
Band XI	Downlink	$3712 \leq n \leq 3812$	$n \div 5 + 736$
	Uplink	$3487 \leq n \leq 3587$	$n \div 5 + 733$
Band XII	Downlink	$3837 \leq n \leq 3903$	$n \div 5 - 37$
		$3927 \leq n \leq 3992$	$n \div 5 - 54.9$
	Uplink	$3612 \leq n \leq 3678$	$n \div 5 - 22$
		$3702 \leq n \leq 3767$	$n \div 5 - 39.9$
Band XIII	Downlink	$4017 \leq n \leq 4043$	$n \div 5 - 55$
		$4067 \leq n \leq 4092$	$n \div 5 - 64.9$
	Uplink	$3792 \leq n \leq 3818$	$n \div 5 + 21$
		$3702 \leq n \leq 3767$	$n \div 5 - 39.9$
Band XIV	Downlink	$4117 \leq n \leq 4143$	$n \div 5 - 63$
		$4167 \leq n \leq 4192$	$n \div 5 - 72.9$
	Uplink	$3892 \leq n \leq 3918$	$n \div 5 + 12$
		$3942 \leq n \leq 3967$	$n \div 5 + 2.1$
Band XIX	Downlink	$712 \leq n \leq 763$	$n \div 5 + 735$
		$787 \leq n \leq 837$	$n \div 5 + 720.1$
	Uplink	$312 \leq n \leq 363$	$n \div 5 + 770$
		$387 \leq n \leq 437$	$n \div 5 + 755.1$

CDMA 2000 / 1xEVDO Channel Number Ranges

Band	Link (Device)	Range	Frequency (MHz)
US Cellular	Uplink (MS, reverse link)	$1 \leq N \leq 799$	$0.030 \times N + 825.000$
		$991 \leq N \leq 1023$	$0.030 \times (N - 1023) + 825.000$
		$1024 \leq N \leq 1323$	$0.030 \times (N - 1024) + 815.040$
	Downlink (BS, forward link)	$1 \leq N \leq 799$	$0.030 \times N + 870.000$
		$991 \leq N \leq 1023$	$0.030 \times (N - 1023) + 870.000$
		$1024 \leq N \leq 1323$	$0.030 \times (N - 1024) + 860.040$
US PCS	Uplink (MS, reverse link)	$0 \leq N \leq 1199$	$1850.000 + 0.050 \times N$
	Downlink (BS, forward link)	$0 \leq N \leq 1199$	$1930.000 + 0.050 \times N$
Japan Cellular Band	Uplink (MS, reverse link)	$1 \leq N \leq 799$	$0.0125 \times (N + 915.000)$
		$801 \leq N \leq 1039$	$0.0125 \times (N - 800) + 898.000$
		$1041 \leq N \leq 1199$	$0.0125 \times (N - 1040) + 887.000$
		$1201 \leq N \leq 1600$	$0.0125 \times (N - 1200) + 893.000$
	Downlink (BS, forward link)	$1 \leq N \leq 799$	$0.0125 \times (N + 860.000)$
		$801 \leq N \leq 1039$	$0.0125 \times (N - 800) + 843.000$
Korean PCS Band	Uplink (MS, reverse link)	$0 \leq N \leq 599$	$0.050 \times N + 1750.000$
	Downlink (BS, forward link)	$0 \leq N \leq 599$	$0.050 \times N + 1840.000$
NMT-450 Band	Uplink (MS, reverse link)	$1 \leq N \leq 400$	$0.025 \times (N - 1) + 450.000$
		$472 \leq N \leq 871$	$0.025 \times (N - 472) + 410.000$
		$1039 \leq N \leq 1473$	$0.020 \times (N - 1024) + 451.010$
		$1536 \leq N \leq 1715$	$0.025 \times (N - 1536) + 479.000$
		$1792 \leq N \leq 2016$	$0.020 \times (N - 1792) + 479.000$
	Downlink (BS, forward link)	$1 \leq N \leq 400$	$0.025 \times (N - 1) + 460.000$
		$472 \leq N \leq 871$	$0.025 \times (N - 472) + 420.000$
		$1039 \leq N \leq 1473$	$0.020 \times (N - 1024) + 461.010$
IMT-2000 Band	Uplink (MS, reverse link)	$0 \leq N \leq 1199$	$1920.000 + 0.050 \times N$
	Downlink (BS, forward link)	$0 \leq N \leq 1199$	$2100.000 + 0.050 \times N$
Upper 700 MHz Band	Uplink (MS, reverse link)	$0 \leq N \leq 240$	$776.000 + 0.050 \times N$
	Downlink (BS, forward link)	$0 \leq N \leq 240$	$746.000 + 0.050 \times N$

Band	Link (Device)	Range	Frequency (MHz)
	forward link)		
Secondary 800 MHz Band	Uplink (MS, reverse link)	$0 \leq N \leq 719$ $720 \leq N \leq 919$	$0.025 \times N + 806.000$ $0.025 \times (N - 720) + 896.000$
	Downlink (BS, forward link)	$0 \leq N \leq 719$ $720 \leq N \leq 919$	$0.025 \times N + 851.000$ $0.025 \times (N - 720) + 935.000$
2.5 GHz IMT Extension	Uplink (MS, reverse link)	$0 \leq N \leq 1399$	$2500.000 + 0.050 \times N$
	Downlink (BS, forward link)	$0 \leq N \leq 1399$	$2620.000 + 0.050 \times N$
US PCS 1.9 GHz	Uplink (MS, reverse link)	$0 \leq N \leq 1299$	$1850.000 + 0.050 \times N$
	Downlink (BS, forward link)	$0 \leq N \leq 1299$	$1930.000 + 0.050 \times N$
AWS	Uplink (MS, reverse link)	$0 \leq N \leq 899$	$1710.000 + 0.050 \times N$
	Downlink (BS, forward link)	$0 \leq N \leq 899$	$2100.000 + 0.050 \times N$
US 2.5 GHz	Uplink (MS, reverse link)	$140 \leq N \leq 1459$	$2495.000 + 0.050 \times N$
	Downlink (BS, forward link)	$140 \leq N \leq 1459$	$2617.000 + 0.050 \times N$
700 Public Safety	Uplink (MS, reverse link)	$0 \leq N \leq 240$	$787.000 + 0.050 \times N$
	Downlink (BS, forward link)	$0 \leq N \leq 240$	$757.000 + 0.050 \times N$
C2K Lower 700	Uplink (MS, reverse link)	$0 \leq N \leq 360$	$698.000 + 0.050 \times N$
	Downlink (BS, forward link)	$0 \leq N \leq 360$	$728.000 + 0.050 \times N$
400 Euro PAMR	Uplink (MS, reverse link)	$1 \leq N \leq 400$	$0.025 \times (N - 1) + 450.000$
		$472 \leq N \leq 871$	$0.025 \times (N - 472) + 410.000$
	Uplink (MS, reverse link)	$1536 \leq N \leq 1715$	$0.025 \times (N - 1536) + 479.000$
	Uplink (MS, reverse link)		
	Downlink (BS, forward link)	$1 \leq N \leq 400$	$0.025 \times (N - 1) + 460.000$
		$472 \leq N \leq 871$	$0.025 \times (N - 472) + 420.000$
	Downlink (BS, forward link)	$1536 \leq N \leq 1715$	$0.025 \times (N - 1536) + 489.000$
	Downlink (BS, forward link)		

Band	Link (Device)	Range	Frequency (MHz)
800 PAMR	Uplink (MS, reverse link)	$0 \leq N \leq 239$	$870.0125 + 0.025 \times N$
	Downlink (BS, forward link)	$0 \leq N \leq 239$	$915.0125 + 0.025 \times N$

LTE FDD Channel Number Ranges

The carrier frequency in the uplink and downlink is designated by the E-UTRA Absolute Radio Frequency Channel Number (EARFCN) in the range 0 – 65535. The relation between EARFCN and the carrier frequency in MHz for the downlink is given by the following equation, where FDL_low and NOffs-DL are given in table 5.4.4-1 and NDL is the downlink EARFCN.

$$FDL = FDL_low + 0.1(NDL - NOffs-DL)$$

The relation between EARFCN and the carrier frequency in MHz for the uplink is given by the following equation where FUL_low and NOffs-UL are given in table 5.4.4-1 and NUL is the uplink EARFCN.

$$FUL = FUL_low + 0.1(NUL - NOffs-UL)$$

Band	Downlink		Uplink			
	FDL_low (MHz)	NOffs-DL	Range of NDL	FUL_low (MHz)	NOffs-UL	Range of NUL
1		2110	0	0 - 599	1920	18000 - 18599
2		1930	600	600 - 1199	1850	18600 - 19199
3		1805	1200	1200 - 1949	1710	19200 - 19949
4		2110	1950	1950 - 2399	1710	19950 - 20399
5		869	2400	2400 - 2649	824	20400 - 20649
6		875	2650	2650 - 2749	830	20650 - 20749
7		2620	2750	2750 - 3449	2500	20750 - 20449
8		925	3450	3450 - 3799	880	21450 - 21799
9		1844.9	3800	3800 - 4149	1749.9	21800 - 22149
10		2110	4150	4150 - 4749	1710	22150 - 22749
11		1475.9	4750	4750 - 4949	1427.9	22750 - 22949

Band	Downlink	Uplink				
12	729	5010	5010 - 5179	699	23010	23010 - 23179
13	746	5180	5180 - 5279	777	23180	23180 - 23279
14	758	5280	5280 - 5379	788	23280	23280 - 23379
...						
17	734	5730	5730 - 5849	704	23730	23730 - 23849
18	860	5850	5850 - 5999	815	23850	23850 - 23999
19	875	6000	6000 - 6149	830	24000	24000 - 24149
20	791	6150	6150 - 6449	832	24150	24150 - 24449
21	1495.9	6450	6450 - 6599	1447.9	24450	24450 - 24599
...						
24	1525	7700	7700 - 8039	1626.5	25700	25700 - 26039
25	1930	8040	8040 - 8689	1850	26040	26040 - 26689
26	859	8690	8690 - 9039	814	26690	26690 - 27039
...						

Note: The channel numbers that designate carrier frequencies so close to the operating band edges that the carrier extends beyond the operating band edge shall not be used. This implies that the first 7, 15, 25, 50, 75 and 100 channel numbers at the lower operating band edge and the last 6, 14, 24, 49, 74 and 99 channel numbers at the upper operating band edge shall not be used for channel bandwidths of 1.4, 3, 5, 10, 15 and 20 MHz respectively.

LTE TDD Channel Number Ranges

The carrier frequency in the uplink and downlink is designated by the E-UTRA Absolute Radio Frequency Channel Number (EARFCN) in the range 0 – 65535. The relation between EARFCN and the carrier frequency in MHz for the downlink is given by the following equation, where FDL_low and NOffs-DL are given in table 5.4.4-1 and NDL is the downlink EARFCN.

$$FDL = FDL_low + 0.1(NDL - NOffs-DL)$$

The relation between EARFCN and the carrier frequency in MHz for the uplink is given by the following equation where FUL_low and NOffs-UL are given in table 5.4.4-1 and NUL is the uplink EARFCN.

$$FUL = FUL_low + 0.1(NUL - NOffs-UL)$$

Band	Downlink		Uplink			
	NOffs-DL	FDL_low (MHz)	Range of ND	FUL_low (MHz)	NOffs-UL	Range of NUL
33	1900	36000	36000 – 36199	1900	36000	36000 – 36199
34	2010	36200	36200 – 36349	2010	36200	36200 – 36349
35	1850	36350	36350 – 36949	1850	36350	36350 – 36949
36	1930	36950	36950 – 37549	1930	36950	36950 – 37549
37	1910	37550	37550 – 37749	1910	37550	37550 – 37749
38	2570	37750	37750 – 38249	2570	37750	37750 – 38249
39	1880	38250	38250 – 38649	1880	38250	38250 – 38649
40	2300	38650	38650 – 39649	2300	38650	38650 – 39649
41	2496	39650	39650 – 41589	2496	39650	39650 – 41589
42	3400	41590	41590 – 43589	3400	41590	41590 – 43589
43	3600	43590	43590 – 45589	3600	43590	43590 – 45589

Note: The channel numbers that designate carrier frequencies so close to the operating band edges that the carrier extends beyond the operating band edge shall not be used. This implies that the first 7, 15, 25, 50, 75 and 100 channel numbers at the lower operating band edge and the last 6, 14, 24, 49, 74 and 99 channel numbers at the upper operating band edge shall not be used for channel bandwidths of 1.4, 3, 5, 10, 15 and 20 MHz respectively.

TDSCDMA Channel Number Ranges

1.28 Mcps TDD Option

No TX-RX frequency separation is required as Time Division Duplex (TDD) is employed. Each subframe consists of 7 main timeslots where all main timeslots (at least the first one) before the single switching point are allocated DL and all main timeslots (at least the last one) after the single switching point are allocated UL.

The nominal channel spacing is 1.6 MHz, but this can be adjusted to optimise performance in a particular deployment scenario.

The carrier frequency is designated by the UTRA absolute radio frequency channel number (UARFCN). The value of the UARFCN in the IMT2000 band is defined in the general case as follows:

$$N_t = 5 * F \quad 0.0 \text{ MHz} \leq F \leq 3276.6 \text{ MHz}$$

where F is the carrier frequency in MHz

Additional channels applicable to operation in the frequency band defined in sub-clause 5.2(d) are defined via the following UARFCN definition:

$$N_t = 5 * (F - 2150.1 \text{ MHz}) / 2572.5 \text{ MHz} \leq F \leq 2617.5 \text{ MHz}$$

UARFCN

1.28 Mcps TDD Option

The following UARFCN range shall be supported for each band:

**Table: UTRA Absolute Radio
Frequency Channel Number 1.28
Mcps TDD Option**

Frequency Band	Frequency Range	UARFCN Uplink and Downlink transmission
For operation in frequency band as defined in subclause 5.2 (a)	1900–1920 MHz	9504 to 9596
	2010–2025 MHz	10054 to 10121
For operation in frequency band as defined in subclause 5.2 (b)	1850–1910 MHz	9254 to 9546
	1930–1990 MHz	9654 to 9946
For operation in frequency band as defined in subclause 5.2 (c)	1910–1930 MHz	9554 to 9646
For operation in frequency band as defined in subclause 5.2 (d)	2570–2620 MHz	12854 to 13096
For operation in frequency band as defined in subclause 5.2 (e)	2300–2400 MHz	11504 to 11996
For operation in frequency band as defined in subclause 5.2 (f)	1880–1920 MHz	9404 to 9596

Radio Setup

Allows access to the sub-menus for selecting the radio standard and associated radio band. You can also set a frequency reference and offset.

This menu is greyed out when on E6630A. Radio band settings for GSM, cdma2000, and so on -- most of which are not actually supported in E6630A, which has three narrow frequency bands. So band settings are grayed out.

Key Path	Source, Frequency
Initial S/W Revision	A.05.00

Radio Standard

Allows access to the channel band sub-menus to select the desired radio standard. When you have selected the radio standard, you can then set an active channel band. The radio standard and the active

channel band allow you to use channel numbers to set frequency automatically.

Key Path	Source, Frequency, Radio Setup
Remote Command	:SOURce:FREQuency:CHANnels:BAND NONE PGSM EGSM RGSM DCS1800 PCS1900 TGSM810 GSM450 GSM480 GSM700 GSM850 BANDI BANDII BANDIII BANDIV BANDV BANDVI BANDVII BANDVIII BANDIX BANDX BANDXI BANDXII BANDXIII BANDXIV BANDXIX USCELL USPCS JAPAN KOREAN NMT IMT2K UPPER SECOND PAMR400 PAMR800 IMTEXT PCS1DOT9G AWS US2DOT5G PUBLIC LOWER BAND1 BAND2 BAND3 BAND4 BAND5 BAND6 BAND7 BAND8 BAND10 BAND11 BAND12 BAND13 BAND14 BAND17 BAND18 BAND19 BAND20 BAND21 BAND24 BAND25 BAND26 BAND27 BAND28 BAND29 BAND30 BAND31 BAND33 BAND34 BAND35 BAND36 BAND37 BAND38 BAND39 BAND40 BAND41 BAND42 BAND43 BAND44 BANDA BANDB BANDC BANDD BANDE BANDE :SOURce:FREQuency:CHANnels:BAND?
Example	:SOUR:FREQ:CHAN:BAND PGSM
Notes	Set this setting to "NONE" will grey out "Channel" on page 2103 Channel
Initial S/W Revision	A.05.00

None

Selects no radio standard for use. When you have selected the radio standard to NONE, you cannot use channel numbers to set frequency automatically. You will need to set the frequency manually.

Key Path	Source, Frequency, Radio Setup, Radio Standard
Initial S/W Revision	A.05.00

GSM/EDGE

Sets GSM/EDGE as the radio standard for use and accesses the GSM/EDGE specific channel band sub-menus.

Key Path	Source, Frequency, Radio Setup, Radio Standard
Initial S/W Revision	A.05.00

P-GSM

Selects P-GSM as the active channel band.

Key Path	Source, Frequency, Radio Setup, Radio Standard, GSM/EDGE
Example	:SOUR:FREQ:CHAN:BAND PGSM
Initial S/W Revision	A.05.00

E-GSM

Selects E-GSM as the active channel band.

Key Path	Source, Frequency, Radio Setup, Radio Standard, GSM/EDGE
Example	:SOUR:FREQ:CHAN:BAND EGSM
Initial S/W Revision	A.05.00

R-GSM

Selects R-GSM as the active channel band.

Key Path	Source, Frequency, Radio Setup, Radio Standard, GSM/EDGE
Example	:SOUR:FREQ:CHAN:BAND RGSM
Initial S/W Revision	A.05.00

DCS 1800

Selects DCS 1800 as the active channel band.

Key Path	Source, Frequency, Radio Setup, Radio Standard, GSM/EDGE
Example	:SOUR:FREQ:CHAN:BAND DCS1800
Initial S/W Revision	A.05.00

PCS 1900

Selects PCS 1900 as the active channel band.

Key Path	Source, Frequency, Radio Setup, Radio Standard, GSM/EDGE
Example	:SOUR:FREQ:CHAN:BAND PCS1900
Initial S/W Revision	A.05.00

GSM 450

Selects GSM 450 as the active channel band.

Key Path	Source, Frequency, Radio Setup, Radio Standard, GSM/EDGE
Example	:SOUR:FREQ:CHAN:BAND GSM450
Initial S/W Revision	A.05.00

GSM 480

Selects GSM 480 as the active channel band.

Key Path	Source, Frequency, Radio Setup, Radio Standard, GSM/EDGE
Example	:SOUR:FREQ:CHAN:BAND GSM480
Initial S/W Revision	A.05.00

GSM 850

Selects GSM 850 as the active channel band.

Key Path	Source, Frequency, Radio Setup, Radio Standard, GSM/EDGE
Example	:SOUR:FREQ:CHAN:BAND GSM850
Initial S/W Revision	A.05.00

GSM 700

Selects GSM 700 as the active channel band.

Key Path	Source, Frequency, Radio Setup, Radio Standard, GSM/EDGE
Example	:SOUR:FREQ:CHAN:BAND GSM700
Initial S/W Revision	A.05.00

T-GSM 810

Selects T-GSM 810 as the active channel band.

Key Path	Source, Frequency, Radio Setup, Radio Standard, GSM/EDGE
Example	:SOUR:FREQ:CHAN:BAND T-GSM810
Initial S/W Revision	A.05.00

WCDMA

Sets WCDMA as the radio standard for use and accesses the W-CDMA specific channel band sub-menus.

Key Path	Source, Frequency, Radio Setup, Radio Standard
Initial S/W Revision	A.05.00

Band I

Selects Band I as the active channel band.

Key Path	Source, Frequency, Radio Setup, Radio Standard, WCDMA
Example	:SOUR:FREQ:CHAN:BAND BANDI
Initial S/W Revision	A.05.00

Band II

Selects Band II as the active channel band.

Key Path	Source, Frequency, Radio Setup, Radio Standard, WCDMA
Example	:SOUR:FREQ:CHAN:BAND BANDII
Initial S/W Revision	A.05.00

Band III

Selects Band III as the active channel band.

Key Path	Source, Frequency, Radio Setup, Radio Standard, WCDMA
Example	:SOUR:FREQ:CHAN:BAND BANDIII
Initial S/W Revision	A.05.00

Band IV

Selects Band IV as the active channel band.

Key Path	Source, Frequency, Radio Setup, Radio Standard, WCDMA
Example	:SOUR:FREQ:CHAN:BAND BANDIV
Initial S/W Revision	A.05.00

Band V

Selects Band V as the active channel band.

Key Path	Source, Frequency, Radio Setup, Radio Standard, WCDMA
Example	:SOUR:FREQ:CHAN:BAND BANDV
Initial S/W Revision	A.05.00

Band VI

Selects Band VI as the active channel band.

Key Path	Source, Frequency, Radio Setup, Radio Standard, WCDMA
Example	:SOUR:FREQ:CHAN:BAND BANDVI
Initial S/W Revision	A.05.00

Band VII

Selects Band VII as the active channel band.

Key Path	Source, Frequency, Radio Setup, Radio Standard, WCDMA
Example	:SOUR:FREQ:CHAN:BAND BANDVII
Initial S/W Revision	A.05.00

Band VIII

Selects Band VIII as the active channel band.

Key Path	Source, Frequency, Radio Setup, Radio Standard, WCDMA
Example	:SOUR:FREQ:CHAN:BAND BANDVIII
Initial S/W Revision	A.05.00

Band IX

Selects Band IX as the active channel band.

Key Path	Source, Frequency, Radio Setup, Radio Standard, WCDMA
Example	:SOUR:FREQ:CHAN:BAND BANDIX
Initial S/W Revision	A.05.00

Band X

Selects Band X as the active channel band.

Key Path	Source, Frequency, Radio Setup, Radio Standard, WCDMA
Example	:SOUR:FREQ:CHAN:BAND BANDX
Initial S/W Revision	A.05.00

Band XI

Selects Band XI as the active channel band.

Key Path	Source, Frequency, Radio Setup, Radio Standard, WCDMA
Example	:SOUR:FREQ:CHAN:BAND BANDXI
Initial S/W Revision	A.05.00

Band XII

Selects Band XII as the active channel band.

Key Path	Source, Frequency, Radio Setup, Radio Standard, WCDMA
Example	:SOUR:FREQ:CHAN:BAND BANDXII
Initial S/W Revision	A.05.00

Band XIII

Selects band XIII as the active channel band.

Key Path	Source, Frequency, Radio Setup, Radio Standard, WCDMA
Example	:SOUR:FREQ:CHAN:BAND BANDXIII
Initial S/W Revision	A.05.00

Band XIV

Selects Band XIV as the active channel band.

Key Path	Source, Frequency, Radio Setup, Radio Standard, WCDMA
Example	:SOUR:FREQ:CHAN:BAND BANDXIV
Initial S/W Revision	A.05.00

LTE

Sets LTE FDD as the radio standard for use and accesses the LTE FDD specific channel band sub-menus..

Key Path	Source, Frequency, Radio Setup, Radio Standard
Initial S/W Revision	A.09.50

BAND 1

Selects BAND 1 as the band for the current step.

Key Path	Source, Frequency, Radio Setup, Radio Standard, LTE
----------	---

Example	:SOUR:FREQ:CHAN:BAND BAND1
Initial S/W Revision	A.09.50

BAND 2

Selects BAND 2 as the band for the current step.

Key Path	Source, Frequency, Radio Setup, Radio Standard, LTE
Example	:SOUR:FREQ:CHAN:BAND BAND2
Initial S/W Revision	A.09.50

BAND 3

Selects BAND 3 as the band for the current step.

Key Path	Source, Frequency, Radio Setup, Radio Standard, LTE
Example	:SOUR:FREQ:CHAN:BAND BAND3
Initial S/W Revision	A.09.50

BAND 4

Selects BAND 4 as the band for the current step.

Key Path	Source, Frequency, Radio Setup, Radio Standard, LTE
Example	:SOUR:FREQ:CHAN:BAND BAND4
Initial S/W Revision	A.09.50

BAND 5

Selects BAND 5 as the band for the current step.

Key Path	Source, Frequency, Radio Setup, Radio Standard, LTE
Example	:SOUR:FREQ:CHAN:BAND BAND5
Initial S/W Revision	A.09.50

BAND 6

Selects BAND 6 as the band for the current step.

Key Path	Source, Frequency, Radio Setup, Radio Standard, LTE
----------	---

Example	:SOUR:FREQ:CHAN:BAND BAND6
Initial S/W Revision	A.09.50

BAND 7

Selects BAND 7 as the band for the current step.

Key Path	Source, Frequency, Radio Setup, Radio Standard, LTE
Example	:SOUR:FREQ:CHAN:BAND BAND7
Initial S/W Revision	A.09.50

BAND 8

Selects BAND 8 as the band for the current step.

Key Path	Source, Frequency, Radio Setup, Radio Standard, LTE
Example	:SOUR:FREQ:CHAN:BAND BAND8
Initial S/W Revision	A.09.50

BAND 9

Selects BAND 9 as the band for the current step.

Key Path	Source, Frequency, Radio Setup, Radio Standard, LTE
Example	:SOUR:FREQ:CHAN:BAND BAND9
Initial S/W Revision	A.09.50

BAND 10

Selects BAND 10 as the band for the current step.

Key Path	Source, Frequency, Radio Setup, Radio Standard, LTE
Example	:SOUR:FREQ:CHAN:BAND BAND10
Initial S/W Revision	A.09.50

BAND 11

Selects BAND 11 as the band for the current step.

Key Path	Source, Frequency, Radio Setup, Radio Standard, LTE
----------	---

Example	:SOUR:FREQ:CHAN:BAND BAND11
Initial S/W Revision	A.09.50

BAND 12

Selects BAND 12 as the band for the current step.

Key Path	Source, Frequency, Radio Setup, Radio Standard, LTE
Example	:SOUR:FREQ:CHAN:BAND BAND12
Initial S/W Revision	A.09.50

BAND 13

Selects BAND 13 as the band for the current step.

Key Path	Source, Frequency, Radio Setup, Radio Standard, LTE
Example	:SOUR:FREQ:CHAN:BAND BAND13
Initial S/W Revision	A.09.50

BAND 14

Selects BAND 14 as the band for the current step.

Key Path	Source, Frequency, Radio Setup, Radio Standard, LTE
Example	:SOUR:FREQ:CHAN:BAND BAND14
Initial S/W Revision	A.09.50

BAND 17

Selects BAND 17 as the band for the current step.

Key Path	Source, Frequency, Radio Setup, Radio Standard, LTE
Example	:SOUR:FREQ:CHAN:BAND BAND17
Initial S/W Revision	A.09.50

BAND 18

Selects BAND 18 as the band for the current step.

Key Path	Source, Frequency, Radio Setup, Radio Standard, LTE
----------	---

Example	:SOUR:FREQ:CHAN:BAND BAND18
Initial S/W Revision	A.09.50

BAND 19

Selects BAND 19 as the band for the current step.

Key Path	Source, Frequency, Radio Setup, Radio Standard, LTE
Example	:SOUR:FREQ:CHAN:BAND BAND19
Initial S/W Revision	A.09.50

BAND 20

Selects BAND 20 as the band for the current step.

Key Path	Source, Frequency, Radio Setup, Radio Standard, LTE
Example	:SOUR:FREQ:CHAN:BAND BAND20
Initial S/W Revision	A.09.50

BAND 21

Selects BAND 21 as the band for the current step.

Key Path	Source, Frequency, Radio Setup, Radio Standard, LTE
Example	:SOUR:FREQ:CHAN:BAND BAND21
Initial S/W Revision	A.09.50

BAND 24

Selects BAND 24 as the band for the current step.

Key Path	Source, Frequency, Radio Setup, Radio Standard, LTE
Example	:SOUR:FREQ:CHAN:BAND BAND24
Initial S/W Revision	A.09.50

BAND 25

Selects BAND 25 as the band for the current step.

Key Path	Source, Frequency, Radio Setup, Radio Standard, LTE
----------	---

Example	:SOUR:FREQ:CHAN:BAND BAND25
Initial S/W Revision	A.09.50

BAND 26

Selects BAND 26 as the band for the current step.

Key Path	Source, Frequency, Radio Setup, Radio Standard, LTE
Example	:SOUR:FREQ:CHAN:BAND BAND26
Initial S/W Revision	A.12.53

BAND 27

Selects BAND 27 as the band for the current step.

Key Path	Source, Frequency, Radio Setup, Radio Standard, LTE
Example	:SOUR:FREQ:CHAN:BAND BAND27
Initial S/W Revision	A.14.00

BAND 28

Selects BAND 28 as the band for the current step.

Key Path	Source, Frequency, Radio Setup, Radio Standard, LTE
Example	:SOUR:FREQ:CHAN:BAND BAND28
Initial S/W Revision	A.14.00

BAND 31

Selects BAND 31 as the band for the current step.

Key Path	Source, Frequency, Radio Setup, Radio Standard, LTE
Example	:SOUR:FREQ:CHAN:BAND BAND31
Initial S/W Revision	A.14.00

LTE TDD

Sets LTE TDD as the radio standard for use and accesses the LTE TDD specific channel band sub-menus..

Key Path	Source, Frequency, Radio Setup, Radio Standard
Initial S/W Revision	A.11.50

BAND 33

Selects BAND 33 as the band for the current step.

Key Path	Source, Frequency, Radio Setup, Radio Standard, LTE TDD
Example	:SOUR:FREQ:CHAN:BAND BAND33
Initial S/W Revision	A.11.50

BAND 34

Selects BAND 34 as the band for the current step.

Key Path	Source, Frequency, Radio Setup, Radio Standard, LTE TDD
Example	:SOUR:FREQ:CHAN:BAND BAND34
Initial S/W Revision	A.11.50

BAND 35

Selects BAND 35 as the band for the current step.

Key Path	Source, Frequency, Radio Setup, Radio Standard, LTE TDD
Example	:SOUR:FREQ:CHAN:BAND BAND35
Initial S/W Revision	A.11.50

BAND 36

Selects BAND 36 as the band for the current step.

Key Path	Source, Frequency, Radio Setup, Radio Standard, LTE TDD
Example	:SOUR:FREQ:CHAN:BAND BAND36
Initial S/W Revision	A.11.50

BAND 37

Selects BAND 37 as the band for the current step.

Key Path	Source, Frequency, Radio Setup, Radio Standard, LTE TDD
Example	:SOUR:FREQ:CHAN:BAND BAND37
Initial S/W Revision	A.11.50

BAND 38

Selects BAND 38 as the band for the current step.

Key Path	Source, Frequency, Radio Setup, Radio Standard, LTE TDD
Example	:SOUR:FREQ:CHAN:BAND BAND38
Initial S/W Revision	A.11.50

BAND 39

Selects BAND 39 as the band for the current step.

Key Path	Source, Frequency, Radio Setup, Radio Standard, LTE TDD
Example	:SOUR:FREQ:CHAN:BAND BAND39
Initial S/W Revision	A.11.50

BAND 40

Selects BAND 40 as the band for the current step.

Key Path	Source, Frequency, Radio Setup, Radio Standard, LTE TDD
Example	:SOUR:FREQ:CHAN:BAND BAND40
Initial S/W Revision	A.11.50

BAND 41

Selects BAND 41 as the band for the current step.

Key Path	Source, Frequency, Radio Setup, Radio Standard, LTE TDD
Example	:SOUR:FREQ:CHAN:BAND BAND41
Initial S/W Revision	A.11.50

BAND 42

Selects BAND 42 as the band for the current step.

Key Path	Source, Frequency, Radio Setup, Radio Standard, LTE TDD
Example	:SOUR:FREQ:CHAN:BAND BAND42
Initial S/W Revision	A.11.50

BAND 43

Selects BAND 43 as the band for the current step.

Key Path	Source, Frequency, Radio Setup, Radio Standard, LTE TDD
Example	:SOUR:FREQ:CHAN:BAND BAND43
Initial S/W Revision	A.11.50

BAND 44

Selects BAND 44 as the band for the current step.

Key Path	Source, Frequency, Radio Setup, Radio Standard, LTE TDD
Example	:SOUR:FREQ:CHAN:BAND BAND44
Initial S/W Revision	A.14.00

TDSCDMA

Sets TDSCDMA as the radio standard for use and accesses the TDSCDMA specific channel band sub-menus..

Key Path	Source, Frequency, Radio Setup, Radio Standard
Initial S/W Revision	A.11.50

BAND A

Selects BAND A as the band for the current step.

Key Path	Source, Frequency, Radio Setup, Radio Standard, TDSCDMA
Example	:SOUR:FREQ:CHAN:BAND BANDA
Initial S/W Revision	A.11.50

BAND B

Selects BAND B as the band for the current step.

Key Path	Source, Frequency, Radio Setup, Radio Standard, TDSCDMA
Example	:SOUR:FREQ:CHAN:BAND BANDB
Initial S/W Revision	A.11.50

BAND C

Selects BAND C as the band for the current step.

Key Path	Source, Frequency, Radio Setup, Radio Standard, TDSCDMA
Example	:SOUR:FREQ:CHAN:BAND BANDC
Initial S/W Revision	A.11.50

BAND D

Selects BAND D as the band for the current step.

Key Path	Source, Frequency, Radio Setup, Radio Standard, TDSCDMA
Example	:SOUR:FREQ:CHAN:BAND BANDD
Initial S/W Revision	A.11.50

BAND E

Selects BAND E as the band for the current step.

Key Path	Source, Frequency, Radio Setup, Radio Standard, TDSCDMA
Example	:SOUR:FREQ:CHAN:BAND BANDE
Initial S/W Revision	A.11.50

BAND F

Selects BAND F as the band for the current step.

Key Path	Source, Frequency, Radio Setup, Radio Standard, TDSCDMA
Example	:SOUR:FREQ:CHAN:BAND BANDF
Initial S/W Revision	A.11.50

Radio Band Link

Allows you to specify the channel band type as either uplink or downlink link direction. This value is used in conjunction with the channel band and channel number to determine the absolute frequency output by the source. When set to "Uplink", the source will calculate the uplink frequency using an uplink formula together with the selected channel band and channel number. When set to "Downlink", the source will calculate the downlink frequency using a downlink formula together with the selected channel band and channel number.

Key Path	Source, Frequency, Radio Setup
Remote Command	:SOURce:RADio:BAND:LINK DOWN UP :SOURce:RADio:BAND:LINK?

Example	:SOUR:RAD:BAND:LINK UP
Preset	DOWN
Range	DOWN UP
Backwards Compatibility SCPI	:SOURce:RADio:DEVIce BTS MS
	:SOURce:RADio:DEVIce?
Backwards Compatibility Notes	BTS maps to the Downlink frequency MS maps to the Uplink frequency
Initial S/W Revision	A.05.00

Set Reference Frequency

This key allows you to set the frequency reference. Pressing this key turns the frequency reference state to ON, sets the reference frequency value to the current frequency, maintains this frequency at the RF output, and sets the displayed frequency to 0.00 Hz. All subsequent frequencies entered under Source>Frequency>Frequency are interpreted as being relative to this reference frequency.

When you use a frequency reference, the signal generator outputs a frequency that is set relative to the reference frequency by the value entered under Source>Frequency>Frequency as follows:

Output frequency = reference frequency - entered frequency

Where:

reference frequency equals the original RF frequency entered under Source>Frequency>Frequency and set as the reference frequency

entered frequency equals a new value entered under Source>Frequency>Frequency

In addition, the displayed frequency value will be the same as the value entered under Source>Frequency>Frequency.

NOTE

If Freq Reference is set to ON with a reference value set, entering a value under Source>Frequency>Frequency and pressing Set Frequency Reference will add that value to the existing Freq Reference value.

If you wish to change the reference frequency value to the new value entered under Source>Frequency>Frequency, first you must set Freq Reference to OFF and then press Set Frequency Reference.

Key Path	Source, Frequency
Remote Command	:SOURce:FREQuency:REFerence:SET
Example	:SOUR:FREQ:REF:SET
Dependencies	This setting is unavailable, and is grayed out when the List Sequencer is turned ON.
Initial S/W Revision	A.05.00

Freq Reference

This key allows you to toggle the state of the frequency reference. When the frequency reference state is ON, an annunciator is displayed on the main source view to indicate this state to the user.

When you use a frequency reference, the signal generator outputs a frequency that is set relative to the reference frequency by the value entered under Source>Frequency>Frequency as follows:

Output frequency = reference frequency + entered frequency

Where:

reference frequency equals the original RF frequency entered under Source>Frequency>Frequency and set as the reference frequency

entered frequency equals a new value entered under Source>Frequency>Frequency

For more information on Reference Frequency refer to ["Set Reference Frequency" on page 2127](#)

Key Path	Source, Frequency
Remote Command	:SOURce:FREQuency:REFerence <freq> :SOURce:FREQuency:REFerence? :SOURce:FREQuency:REFerence:STATe OFF ON 0 1 :SOURce:FREQuency:REFerence:STATe?
Example	:SOUR:FREQ:REF 0.00 Hz :SOUR:FREQ:REF:STATe ON
Dependencies	This setting is unavailable, and is grayed out when the List Sequencer is turned ON.
Couplings	The frequency reference state is coupled to the frequency reference set immediate action. When the reference set immediate action key is pressed, or the SCPI command issued, it turns the frequency reference state ON.
Preset	0.00 Hz OFF
Min	0.00 Hz
Max	Hardware Dependant: Option 503 = 3.6 GHz Option 504 = 3.8 GHz Option 506 = 6.00 GHz
Initial S/W Revision	A.05.00

Freq Offset

Allows you to specify the frequency offset value. When the frequency offset state is ON, an annunciator is displayed on the main source view to indicate this state to the user.

When the frequency offset is set to zero (0) and you set a new offset value, the displayed frequency value will change as follows and the RF output frequency will not change:

Displayed value = output frequency + offset value

Where:

output frequency equals the original frequency entered under Source>Frequency>Frequency

offset value equals the value entered under Source>Frequency>Freq Offset

When the frequency offset is set to a value other than zero (0) and you enter a new frequency value under Source>Frequency>Frequency, the displayed frequency will be the same as the value entered and the RF output frequency will be equal to the value entered minus the offset value as follows:

Output frequency = entered frequency – offset frequency

Displayed frequency = output frequency + offset frequency

Displayed frequency = entered frequency

Where:

entered frequency equals the frequency entered under Source>Frequency>Frequency

offset frequency equals the value previously entered and set under Source>Frequency>Freq Offset

Key Path	Source, Frequency
Remote Command	:SOURce:FREQuency:OFFSet <freq> :SOURce:FREQuency:OFFSet?
Example	:SOUR:FREQ:OFFS 0 Hz
Dependencies	This setting is unavailable, and is grayed out when the List Sequencer is turned ON.
Preset	0 Hz
Min	-100.00 GHz
Max	100.00 GHz
Initial S/W Revision	A.05.00

Modulation Setup

Allows access to the menus for setting up the available modulation types: "ARB" on page 2143, "AM" on page 2164, "FM" on page 2165, and "PM" on page 2167.

Key Path	Source
Initial S/W Revision	A.05.00

ARB

Allows you access to the ARB sub-menus.

Key Path	Source, Modulation Setup
Initial S/W Revision	A.05.00

ARB

Allows you to toggle the state of the ARB function. When the ARB is On, a “MOD” annunciator is displayed in the system settings panel. When the ARB is turned Off, the MOD annunciator is cleared

Key Path	Source, Modulation Setup, ARB
Remote Command	:SOURce:RADio:ARB[:STATe] ON OFF 1 0 :SOURce:RADio:ARB[:STATe]?
Example	:SOUR:RAD:ARB OFF :SOUR:RAD:ARB?
Notes	If the ARB is ON, a user then loads or deletes another file to ARB memory, the playing waveform segment may not keep phase continuity during the ARB memory operation. The waveform will be replayed after the ARB operation is finished.
Dependencies	This setting is for independent mode and has no effect on 3.3.8 list sequencer mode. Setting "Sequencer" on page 2168 Sequencer to On will put source enter list sequencer mode, and even if ARB state is On, the ARB file will not be played. Setting "Sequencer" on page 2168 Sequencer to Off will make source leave list sequencer mode, and this setting will take effect immediately. The ARB can only be turned on when there is a waveform file selected for playback. On the GUI if no waveform is selected, this key is grayed out. If you send the SCPI command to turn the ARB on with no waveform selected for playback, the ARB state remains OFF and an error is generated. "- When you try to recall a certain set of states in which the selected waveform is not in ARB memory and the ARB state is On, errors are reported
Preset	Off
Range	On Off
Initial S/W Revision	A.05.00

Select Waveform

Allows you to access to the waveform selection sub-menus.

Pressing this key changes the central view area to show the Waveform File Selection view.

Key Path	Source, Modulation Setup, ARB
Initial S/W Revision	A.05.00

Select Waveform

Allows you to select a waveform sequence or segment for the dual ARB to play.

NOTE: Selecting a waveform file does not result in automatic adjustments to burst timing (to compensate for the presence or absence of a Multiport Adapter); that adjustment occurs only when a waveform is loaded to ARB memory. See "Load Segment to ARB Memory" for more information about this adjustment.

Key Path	Source, Modulation Setup, ARB, Select Waveform
Remote Command	:SOURce:RADio:ARB:WAVeform <string> :SOURce:RADio:ARB:WAVeform?
Example	:SOUR:RAD:ARB:WAV "test_waveform.bin"
Notes	<p>If intended waveform is not in the memory yet, then issuing this command by SCPI will invoke ARB loading operation first, which involves a delay of unpredictable length. So this command should be followed by the query *OPC?, which holds off subsequent commands until the loading operation is complete.</p> <p><string> - specifies the name of the waveform segment or waveform sequence to be played by the ARB.</p> <p>When in Sequence Analyzer mode, and Include Source is Yes, if the you attempt to play a waveform sequence but not all the required waveform segments are in the ARB playback memory, the application will reject the loading operation with an error is generated .</p> <p>When Include Source is No, if you attempt to play a waveform sequence but not all the required waveform segments are contained in the ARB playback memory, the application will attempt to load the required segments from either the default directory of the current directory. If the ARB memory does not have enough space for all the waveform segments to be loaded, an error is generated and none of the waveform segments is loaded.</p> <p>If the ARB is ON, and you attempt to play a waveform sequence but not all the waveform segments within the sequence could be found to be loaded into ARB memory, an error is generated. The selected waveform keeps the previous value and ARB state remains On.</p> <p>If you specify a waveform segment over SCPI but the waveform segment is not present within ARB playback memory and cannot be found for auto loading within the current directory or the default directory, an error is generated and the file selection remains unchanged.</p> <p>If you select a waveform for playback and the waveform requires a license that is not installed on the instrument, an error is generated.</p> <p>If the ARB is ON and you load a file to ARB memory or delete a file from ARB memory, the playing waveform segment may not keep phase continuity during the ARB memory operation. The waveform will be replayed after the ARB operation is finished.</p>
Initial S/W Revision	A.05.00

Segments on Hard Disk

Allows you access to the sub-menus for loading waveform segments from the hard disk into ARB memory. The default directory is: D: varb.

Pressing this key changes the current view to the Waveform Management View.

Key Path	Source, Modulation Setup, ARB, Select Waveform
Initial S/W Revision	A.05.00

Load Segment To ARB Memory

Allows you to load the selected file into ARB memory. On the front panel you select the file for loading to the ARB memory by highlighting the desired file in the list. Using the SCPI command, you specify the file

name on the HDD.

“NVWFM” (none-volatile storage) MSUS (Mass Storage Unit Specifier) is supported in the memory subsystem because the ARB memory cannot be accessed directly. Therefore, files must be downloaded to the instrument hard disk and then loaded into the ARB memory. “NVWFM” MSUS will be mapped to the default directory D: VARB. The SCPI command supports using either “NVWFM” MSUS or specifying a full path. For more information, see Memory Subsystem (Remote Command Only).

If a file of the same name already exists within ARB memory, it is overwritten. If you wish to load two segments of the same name, you must rename one of the segments before loading it into ARB memory. To rename a segment, you can either use Windows File Explorer, or the :MMEMORY:COPY command.

NOTE: When a waveform file is loaded to ARB memory, burst timing adjustments are made automatically, based on whether or not a Multiport Adapter is connected to the test set and powered on. If the connection/power status of the Multiport Adapter is changed after a waveform file has been loaded, it needs to be loaded again.

Key Path	Source, Modulation Setup, ARB, Select Waveform, Segments on Hard Disk
Remote Command	:SOURCE:RADio:ARB:LOAD <string>
Example	:SOUR:RAD:ARB:LOAD "D: VARB\testwaveform.bin" or :SOUR:RAD:ARB:LOAD "NVWFM:testwaveform.bin"
Notes	<p>Because loading the file involves a delay of unpredictable length, this command should be followed by the query *OPC?, which holds off subsequent commands until the loading operating is complete.</p> <p><string> - specifies the path name of the file to load from the HDD into ARB memory. It could be a <full path + filename>, or <"NVWFM" MSUS + colon + filename>.</p> <p>When in Sequence Analyzer mode, and Include Source is Yes, an attempt to load a file to ARB memory will be rejected with an error.</p> <p>When Include Source is No and if there is insufficient free ARB memory to load the selected waveform, an error is generated. .</p> <p>If you specify a file over SCPI, but the file is not at the specified location, an error is generated.</p> <p>If you try to load a waveform file but the file contains less than 500 IQ samples, an error is generated.</p> <p>If you try to load a Signal Studio waveform "*.wfm" which contains invalid waveform header, an error is generated.</p> <p>If the ARB is ON when you load a file to ARB memory or delete a file from ARB memory, the playing waveform segment may not keep phase continuity during the ARB memory operation. The waveform will be replayed after the ARB operation is finished.</p> <p>ARB can be loaded into ARB memory even required licenses do not present on the instrument. In this case, a GUI only warning message -800, "Operation complete; Loaded <filename> successfully, but no license <required licenses> installed". User can install required licenses according to <required licenses> string to license it, or multi-pack license it.</p>
Initial S/W Revision	A.05.00

Load All To ARB Memory

Allows you to load all the segment files within the currently selected directory into ARB memory. If a file of the same name already exists within ARB memory, it is overwritten. If you wish to load two segments of the

same name, you must rename one of the segments before loading it into ARB memory. To rename a segment, you can either use Windows File Explorer, or the :MEMory:COpy command.

NOTE: When a waveform file is loaded to ARB memory, burst timing adjustments are made automatically, based on whether or not a Multiport Adapter is connected to the test set and powered on. If the connection/power status of the Multiport Adapter is changed after a waveform file has been loaded, it needs to be loaded again.

Key Path	Source, Modulation Setup, ARB, Select Waveform, Segments on Hard Disk
Remote Command	:SOURce:RADio:ARB:LOAD:ALL <string>
Example	:SOUR:RAD:ARB:LOAD:ALL "D: varb"
Notes	<p><string> - specifies the directory on the HDD to load the files into ARB memory from.</p> <p>When in Sequence Analyzer mode, and Include Source is Yes, an attempt to load all files from a directory to ARB memory is rejected with an error.</p> <p>When Include Source is No and there is insufficient free ARB memory to load all the waveforms, when the ARB memory is full, the copy ceases, and an error is generated.</p> <p>If you specify a directory over SCPI, but the directory does not exist, an error is generated.</p> <p>If the ARB is ON, a user then loads or deletes file to ARB memory, the playing waveform segment may not keep phase continuity during the ARB memory operation. The waveform will be replayed after the ARB operation is finished.</p>
Initial S/W Revision	A.05.00

Change Directory...

Allows you to change the currently selected directory on the hard disk. Pressing this key opens a standard windows change directory dialog allowing you to select the new directory of interest.

The current directory is used for manually loading waveform segments into ARB memory for playback, and as a search location for waveform segments that are required to be loaded into ARB memory for playback of a waveform sequence or a list sequence.

Key Path	Source, Modulation Setup, ARB, Select Waveform, Segments on Hard Disk
Notes	No remote command, SCPI front panel only.
Initial S/W Revision	A.05.00

Default Directory...

Allows you to change the default directory. It is used as a search location for waveform segments that are required to be loaded into ARB memory for playback of a waveform sequence, and as a search location for selecting waveforms using SCPI.

Key Path	Source, Modulation Setup, ARB, Select Waveform, Segments on Hard Disk
Remote Command	:SOURce:RADio:ARB:DEFault:DIRectory <string> :SOURce:RADio:ARB: DEFault:DIRectory?
Example	:SOUR:RAD:ARB:DEF:DIR "D:\ArbFiles"

	:SOUR:RAD:ARB:DEF:DIR?
State Saved	Persistent, survives a power cycle and a preset but not saved in the instrument state
Initial S/W Revision	A.05.00

Segments in ARB Memory

Allows you access to the sub-menus for managing the files within ARB memory.

Key Path	Source, Modulation Setup, ARB, Select Waveform
Initial S/W Revision	A.05.00

Delete Segment From ARB Mem

Allows you to remove a segment from ARB playback memory.

Key Path	Source, Modulation Setup, ARB, Select Waveform, Segments in ARB Memory
Remote Command	:SOURce:RADio:ARB:DELeTe <string>
Example	:SOUR:RAD:ARB:DEL "testwaveform.bin"
Notes	<p><string> - specifies the waveform to be deleted from the ARB playback memory.</p> <p>When in Sequence Analyzer mode and Include Source is Yes, an attempt to delete a file from ARB memory is rejected with an error.</p> <p>When Include Source is No and you specify a file that does not exist within ARB memory, an error is generated.</p> <p>It is possible to delete files from within the ARB memory when the ARB is ON. However, if you attempt to delete the file that is currently playing an error is generated.</p> <p>It is possible to delete a file from within the ARB memory when the sequencer state is ON and the file is not being used by the List Sequencer. If you attempt to delete a file which is being used by the list sequencer, an error is generated.</p> <p>When sequencer state is On, even if ARB state is On, the selected waveform will not be played. In this case, if the selected waveform is not used in List Sequence, it can be deleted and the ARB state is turned Off.</p> <p>If the ARB is ON and you load a file to ARB memory or delete a file from ARB memory, the playing waveform segment may not keep phase continuity during the ARB memory operation. The waveform will be replayed after the ARB operation is finished.</p>
Initial S/W Revision	A.05.00

Delete All From ARB Memory

Allows you to remove all segments from ARB playback memory.

Key Path	Source, Modulation Setup, ARB, Select Waveform, Segments in ARB Memory
----------	--

Remote Command	:SOURce:RADio:ARB:DELeTe:ALL
Example	:SOUR:RAD:ARB:DELeTe:ALL
Notes	<p>When in Sequence Analyzer mode and Include Source is Yes, an attempt to delete all files from ARB memory is rejected with an error.</p> <p>When Include Source is No and you attempt to delete all files from ARB memory when the ARB is currently playing a file, all files except the one playing are deleted and an error is generated.</p> <p>If you attempt to delete all files from ARB memory when there are waveform files used in "List Sequencer" on page 2168 and "Sequencer" on page 2168 state is ON, all files except the files currently being used in list sequencer are deleted, and an error is generated.</p> <p>If the ARB is ON and you load a file to ARB memory or delete a file from ARB memory, the playing waveform segment may not keep phase continuity during the ARB memory operation. The waveform will be replayed after the ARB operation is finished.</p>
Initial S/W Revision	A.05.00

ARB Setup

Allows access to the ARB setup sub-menus.

Key Path	Source, Modulation Setup, ARB
Initial S/W Revision	A.05.00

Sample Rate

Allows you to set the ARB waveform playback sample rate.

Key Path	Source, Modulation Setup, ARB, ARB Setup
Remote Command	:SOURce:RADio:ARB:SCLock:RATE <freq> :SOURce:RADio:ARB:SCLock:RATE?
Example	:SOUR:RAD:ARB:SCL:RATE 48.00 MHz
Notes	If there is a sample rate specified in the header of the waveform file, changing that sample rate is not recommended, as it may cause problems with burst timing.
Dependencies	When a new waveform is selected for playback the settings contained within the associated waveform header file are applied to the ARB. The sample rate is one of the values stored within the header file. If the newly selected waveform file has an associated header file, the sample rate is updated with the value from the header file. The sample rate will remain unchanged if the newly selected waveform does not have an associated header file.
Preset	125.00 MHz
Min	1.00 kHz
Max	125.00 MHz
Initial S/W Revision	A.05.00

Run-Time Scaling

Allows you to adjust the run-time scaling value. The run-time scaling value is applied in real-time while the waveform is playing.

Key Path	Source, Modulation Setup, ARB, ARB Setup
Remote Command	:SOURce:RADio:ARB:RSCaling <real> :SOURce:RADio:ARB:RSCaling?
Example	:SOUR:RAD:ARB:RSC 100.00
Notes	This setting cannot be set in E6640A/M9420A. Grey out on menu and the value is fixed at 70.00%.
Dependencies	When a new waveform is selected for playback the settings contained within the associated waveform header file are applied to the ARB. The run-time scaling is one of the values stored within the header file. If the newly selected waveform file has an associated header file, the run-time scaling is updated with the value from the header file. The run-time scaling will remain unchanged if the newly selected waveform does not have an associated header file.
Preset	70.00 %
Min	1.00 %
Max	100.00 %
Initial S/W Revision	A.05.00

Baseband Freq Offset

Allows you to adjust the value by which the baseband frequency is offset relative to the carrier.

Key Path	Source, Modulation Setup, ARB, ARB Setup
Remote Command	:SOURce:RADio:ARB:BASEband:FREQuency:OFFSet <freq> :SOURce:RADio:ARB:BASEband:FREQuency:OFFSet?
Example	:SOUR:RAD:ARB:BAS:FREQ:OFFS 0.00 Hz
Dependencies	When a new waveform is selected for playback the settings contained within the associated waveform header file are applied to the ARB. The baseband frequency offset is one of the values stored within the header file. If the newly selected waveform file has an associated header file, the baseband frequency offset is updated with the value from the header file. The baseband frequency offset will remain unchanged if the newly selected waveform does not have an associated header file.
Preset	0.00 Hz
Min	-50.00 MHz
Max	50.00 MHz
Initial S/W Revision	A.05.00

Edit RMS

Allows you to edit or calculate current RMS of selected waveform.

Key Path	Source, Modulation Setup, ARB, ARB Setup
Initial S/W Revision	A.14.50

Current RMS

Allows you to directly specify current RMS value used to playback currently selected waveform. Please note incorrect RMS value may cause inaccurate power output in E6640A/M9420A that is sensitive to RMS value.

This setting is also updated by RMS in waveform header or updated when invoking RMS calculation operation.

This setting can be saved to the header of currently selected waveform by invoking ["Save Setup To Header" on page 2164](#) "Save Setup To Header".

Key Path	Source, Modulation Setup, ARB, ARB Setup, Edit RMS
Remote Command	:SOURce:RADio:ARB:RMS <float> :SOURce:RADio:ARB:RMS?
Example	:SOUR:RAD:ARB:HEAD:RMS 0.7 :SOUR:RAD:ARB:HEAD:RMS?
Notes	Valid range is 0 to 1.414, values outside the range will be clipped to the closest boundary. Note this value does not affect "List Sequencer" on page 2168 Source List Sequencer that always uses RMS value resides in each ARB header. If want this value to take effect in list sequencer, use "Save Setup To Header" on page 2164 "Save Setup to Header" to save current RMS value to header first, then play the ARB in source list sequencer.
Dependencies	When a new waveform is selected for playback, this setting is updated by the RMS value defined in associated waveform header file. If selected waveform has no associated header file or header file does not specify RMS value, then instrument will try to calculate out one automatically. Calculating RMS can also update this setting.
Preset	0
Range	0 ~ 1.414
Initial S/W Revision	A.14.50

RMS Calculation Mode

Allows you to specify the mode to calculate the current RMS.

Key Path	Source, Modulation Setup, ARB, ARB Setup, Edit RMS
Remote Command	:SOURce:RADio:ARB:RMS:CALCulation:MODE AUTO M1 M2 M3 M4 :SOURce:RADio:ARB:RMS:CALCulation:MODE?
Example	:SOUR:RAD:ARB:RMS:CALC:MODE AUTO
Notes	If no waveform is selected, or selected waveform is waveform sequence, the key will grey out.

Preset	AUTO
Range	AUTO M1 M2 M3 M4
Initial S/W Revision	A.14.50

Auto

RMS will be calculated based on the whole sample range of current selected waveform.

Key Path	Source, Modulation Setup, ARB, ARB Setup, Edit RMS, Calculate RMS, RMS Calculation Mode
Example	:SOUR:RAD:ARB:RMS:CALC:MODE AUTO
Initial S/W Revision	A.14.50

Marker 1

Selects marker 1 to designate sample range used for RMS calculation.

Key Path	Source, Modulation Setup, ARB, ARB Setup, Edit RMS, Calculate RMS, RMS Calculation Mode , Marker
Example	:SOUR:RAD:ARB:RMS:CALC:MODE M1
Initial S/W Revision	A.14.50

Marker 2

Selects marker 2 to designate sample range used for RMS calculation.

Key Path	Source, Modulation Setup, ARB, ARB Setup, Edit RMS, Calculate RMS, RMS Calculation Mode , Marker
Example	:SOUR:RAD:ARB:RMS:CALC:MODE M2
Initial S/W Revision	A.14.50

Marker 3

Selects marker 3 to designate sample range used for RMS calculation.

Key Path	Source, Modulation Setup, ARB, ARB Setup, Edit RMS, Calculate RMS, RMS Calculation Mode , Marker
Example	:SOUR:RAD:ARB:RMS:CALC:MODE M3
Initial S/W Revision	A.14.50

Marker 4

Selects marker 4 to designate sample range used for RMS calculation.

Key Path	Source, Modulation Setup, ARB, ARB Setup, Edit RMS, Calculate RMS, RMS Calculation Mode , Marker
Example	:SOUR:RAD:ARB:RMS:CALC:MODE M4
Initial S/W Revision	A.14.50

Calculate RMS

Allows you to calculate current RMS based on mode selected. This will update ["Current RMS" on page 2137](#) Current RMS setting.

Key Path	Source, Modulation Setup, ARB, ARB Setup, Edit RMS, Calculate RMS
Remote Command	:SOURce:RADio:ARB:RMS:CALCulate
Example	:SOUR:RAD:ARB:RMS:CALC
Notes	<p>If no waveform is selected, invoking this operation will get error “-221 Setting conflict; No waveform is selected for RMS operation”.</p> <p>If no waveform is selected, or selected waveform is waveform sequence, the key will grey out.</p> <p>If selected waveform does not contain marker data, but "RMS Calculation Mode" on page 2137 “RMS Calculation Mode” is set to marker, under this circumstance, invoking calculation operation will get error “-221 Setting conflict; There is no marker for currently selected waveform, auto RMS calculation mode is used instead”, and "RMS Calculation Mode" on page 2137 “RMS Calculation Mode” will be coupled to “Auto” mode automatically.</p> <p>RMS calculation does not suit for waveform sequence. If selected waveform is waveform sequence file, invoking this operation will get error “-221 Setting conflict; RMS calculation does not apply to waveform sequence”. But users can still edit current RMS as play parameter, and can save current RMS to waveform sequence header for later use.</p>
Initial S/W Revision	A.14.50

Use Header RMS

Allows you to quickly set RMS in ARB header to ["Current RMS" on page 2137](#) Current RMS setting.

Key Path	Source, Modulation Setup, ARB, ARB Setup, Edit RMS,
Notes	<p>No remote command, front panel only.</p> <p>If no waveform is selected, the key will grey out.</p> <p>If no waveform is selected, invoking this operation will get error “-221 Setting conflict; No waveform is selected for RMS operation”.</p>
Initial S/W Revision	A.14.50

Trigger Type

Allows access to the trigger type sub-menus. The setting for trigger type determines the behavior of the waveform when it plays.

Key Path	Source, Modulation Setup, ARB
Remote Command	:SOURce:RADio:ARB:TRIGger:TYPE CONTInuous SINGLE SADVance :SOURce:RADio:ARB:TRIGger:TYPE?
Example	:SOUR:RAD:ARB:TRIG:TYPE CONT :SOUR:RAD:ARB:TRIG:TYPE?
Notes	Gated trigger type will be implemented at a later release
Preset	CONTInuous
Range	Continuous Single Seg Adv
Initial S/W Revision	A.05.00

Continuous

Sets the active trigger type to Continuous. If Continuous is already selected as the active trigger type, pressing this key allows access to the continuous trigger type setup menu. In Continuous trigger mode, the waveform repeats continuously.

Key Path	Source, Modulation Setup, ARB, Trigger Type
Remote Command	:SOURce:RADio:ARB:TRIGger:TYPE:CONTInuous[:TYPE] FREE TRIGger RESet :SOURce:RADio:ARB:TRIGger:TYPE:CONTInuous[:TYPE]?
Example	:SOUR:RAD:ARB:TRIG:TYPE:CONT FREE
Preset	FREE
Range	Free Run Trigger + Run Reset + Run
Initial S/W Revision	A.05.00

Free Run

Selects Free Run as the trigger response for the continuous trigger type. Free Run sets the waveform generator to play a waveform sequence or segment continuously, without waiting for a trigger. In this mode, the waveform generator does not respond to triggers.

Key Path	Source, Modulation Setup, ARB, Trigger Type, Continuous
Example	:SOUR:RAD:ARB:TRIG:TYPE:CONT FREE
Initial S/W Revision	A.05.00

Trigger + Run

Sets Trigger and Run as the trigger response for the continuous trigger type. Trigger and Run sets the waveform generator to play a waveform sequence or segment continuously when the first trigger is received, and to ignore any subsequent triggers.

Key Path	Source, Modulation Setup, ARB, Trigger Type, Continuous
Example	:SOUR:RAD:ARB:TRIG:TYPE:CONT TRIG
Initial S/W Revision	A.05.00

Reset + Run

Sets Reset and Run as the trigger response for the continuous trigger type. Reset and Run sets the waveform generator to play a waveform sequence or segment continuously when the first trigger is received. Subsequent triggers reset the waveform sequence or segment to the start, and then play it continuously.

Key Path	Source, Modulation Setup, ARB, Trigger Type, Continuous
Example	:SOUR:RAD:ARB:TRIG:TYPE:CONT RES
Initial S/W Revision	A.05.00

Single

Sets the active trigger type to Single. If Single is already selected as the active trigger type, pressing this key allows access to the single trigger type setup menu. In Single trigger mode, the waveform plays once.

Key Path	Source, Modulation Setup, ARB, Trigger Type
Remote Command	:SOURce:RADio:ARB:RETRigger ON OFF IMMEDIATE :SOURce:RADio:ARB:RETRigger?
Example	:SOUR:RAD:ARB:RETR OFF
Notes	ON: Buffered Trigger OFF: No Retrigger Immediate: Restart on Trigger This is defined as an enumerated SCPI command, with ON OFF being considered as enumerated types rather than Boolean. This means the query will return OFF instead of 0, and ON instead of 1.
Preset	ON
Range	No Retrigger Buffered Trigger Restart on Trigger
Initial S/W Revision	A.05.00

No Retrigger

Selects No Retrigger as the trigger response for single trigger type. No Retrigger sets the waveform generator to play a waveform sequence or segment once when a trigger is received. Any triggers then

received during playback are ignored.

Key Path	Source, Modulation Setup, ARB, Trigger Type, Single
Example	:SOUR:RAD:ARB:RETR OFF
Initial S/W Revision	A.05.00

Buffered Trigger

Selects Buffered Trigger as the trigger response for single trigger type. Buffered Trigger sets the waveform generator to play a waveform sequence or segment once when a trigger is received. If a trigger is received during playback, the waveform generator plays the sequence or segment to the end, then plays the sequence or segment once more.

Key Path	Source, Modulation Setup, ARB, Trigger Type, Single
Example	:SOUR:RAD:ARB:RETR ON
Initial S/W Revision	A.05.00

Restart on Trigger

Selects Restart on Trigger as the trigger response for single trigger type. Restart on Trigger sets the waveform generator to play a waveform sequence or segment once when a trigger is received. If a trigger is received during playback, the waveform generator resets and plays the sequence or segment from the start.

Key Path	Source, Modulation Setup, ARB, Trigger Type, Single
Example	:SOUR:RAD:ARB:RETR IMM
Initial S/W Revision	A.05.00

Segment Advance

Sets the active trigger type to Segment Advance. If Segment Advance is already selected as the active trigger type, pressing this key allows access to the segment advance trigger type setup menu.

Segment Advance triggering allows you to control the playback of waveform segments within a waveform sequence. When a trigger is received the ARB advances to the next waveform segment within the waveform sequence. This type of triggering ignores the repetition count for the waveform segment within the waveform sequence. For example, if a waveform segment has a repetition count of 10 and you select single segment advance triggering mode, the waveform segment will only play once.

Segment Advance triggering can also be used for waveform segments only. In this situation the same waveform segment is played again when a trigger is received.

Key Path	Source, Modulation Setup, ARB, Trigger Type
Remote Command	:SOURce:RADio:ARB:TRIGger:TYPE:SADVance[:TYPE] SINGLE CONTInuous

	:SOURce:RADio:ARB:TRIGger:TYPE:SADVance[:TYPE]?
Example	:SOUR:RAD:ARB:TRIG:TYPE:SADV SING
Preset	CONTInuous
Range	Single Continuous
Initial S/W Revision	A.05.00

Single

Selects Single as the trigger response for Segment Advance trigger type. With single selected, once a trigger is received a segment is played once. If a trigger is received during playback of a segment, the segment plays to completion and the next segment is played once.

Key Path	Source, Modulation Setup, ARB, Trigger Type, Segment Advance
Example	:SOUR:RAD:ARB:TRIG:TYPE:SADV SING
Initial S/W Revision	A.05.00

Continuous

Selects Continuous as the trigger response for Segment Advance trigger type. With continuous selected, once a trigger is received a segment is played continuously. When subsequent triggers are received, the currently playing segment plays to completion and then the next segment is played continuously.

Key Path	Source, Modulation Setup, ARB, Trigger Type, Segment Advance
Example	:SOUR:RAD:ARB:TRIG:TYPE:SADV CONT
Initial S/W Revision	A.05.00

ARB

Allows you access to the ARB sub-menus.

Key Path	Source, Modulation Setup
Initial S/W Revision	A.05.00

Trigger Source

The trigger source setting determines how the source receives the trigger that starts the waveform playing. Therefore, this key is grayed out if the trigger type is free run, since free run triggers immediately with no trigger source required.

Key Path	Source, Modulation Setup, ARB
Remote Command	:SOURce:RADio:ARB:TRIGger[:SOURce] KEY BUS EXTernal2

	:SOURce:RADio:ARB:TRIGger[:SOURce]?
Example	:SOUR:RAD:ARB:TRIGger KEY
Dependencies	This key is grayed out if the current trigger type is Continuous, Free Run.
Preset	EXTernal2
Range	Trigger Key Bus External 2
Initial S/W Revision	A.05.00

Trigger Key

Sets the current trigger source to the front panel Trigger key. When Trigger Key is selected, the waveform is triggered when you press the front panel Trigger key.

Key Path	Source, Modulation Setup, ARB, Trigger Source
Example	:SOUR:RAD:ARB:TRIGger KEY
Initial S/W Revision	A.05.00

Bus

Sets the current trigger source to Bus. Selecting Bus trigger source enables triggering over GPIB, LAN, or USB using the :SOURce:RADio:ARB:TRIGger:INITiate command.

Key Path	Source, Modulation Setup, ARB, Trigger Source
Example	:SOUR:RAD:ARB:TRIGger BUS
Initial S/W Revision	A.05.00

External 2

Sets the current trigger source to External 2. Selecting External 2 enables triggering a waveform by an externally applied signal.

Key Path	Source, Modulation Setup, ARB, Trigger Source
Example	:SOUR:RAD:ARB:TRIGger EXT2
Notes	Note: When on E6640A, trigger 2 is a bi-directional trigger port. So when trigger 2 has been configured as OUTPUT type, choosing External 2 as the input trigger for the current step will generate error.
Initial S/W Revision	A.05.00

External Trigger Delay

This key allows you to toggle the state and value of external trigger delay. The value you enter sets a delay time between when an external trigger is received and when it is applied to the waveform. This is key is

active only if you select external trigger as trigger source.

Key Path	Source, Modulation Setup, ARB, Trigger Source
Remote Command	:SOURce:RADio:ARB:TRIGger[:SOURce]:EXTernal:DELay <time> :SOURce:RADio:ARB:TRIGger[:SOURce]:EXTernal:DELay? SOURce:RADio:ARB:TRIGger[:SOURce]:EXTernal:DELay:STATe OFF ON 0 1 :SOURce:RADio:ARB:TRIGger[:SOURce]:EXTernal:DELay:STATe?
Example	:SOUR:RAD:ARB:TRIG:EXT:DEL 100ns :SOUR:RAD:ARB:TRIG:EXT:DEL? :SOUR:RAD:ARB:TRIG:EXT:DEL:STAT ON :SOUR:RAD:ARB:TRIG:EXT:DEL:STAT?
Notes	External trigger delay time set by users will be rounded to the nearest integer multiple of the resolution.
Dependencies	This setting is unavailable and is grayed out when the Trigger Source is not set to external trigger.
Preset	1 ms OFF
Min	0 s
Max	8.589934588 s (Note: This value comes from $4\text{ns} * (2^{31} - 1) = 8589934588\text{ ns}$)
Initial S/W Revision	A.14.50

Trigger Initiate

Used to initiate an immediate trigger event if the trigger source is set to Trigger Key.

Key Path	Source, Modulation Setup, ARB
Notes	No remote command, SCPI front panel only.
Initial S/W Revision	A.05.00

Waveform Sequences

Allows access to the waveform sequence sub-menus. Pressing this key changes the central view area to display the Waveform Sequence List view.

Key Path	Source, Modulation Setup, ARB
Notes	No remote command, SCPI front panel only.
Initial S/W Revision	A.05.00

Build New Sequence

Allows access to the sub-menus for creating a new waveform sequence. Pressing this key changes the central view area to display the Waveform Sequence Creation and Editing view.

Key Path	Source, Modulation Setup, ARB, Waveform Sequences
Notes	No remote command, SCPI front panel only.
Initial S/W Revision	A.05.00

Current Segment

Specifies the selected sequence segment that will be affected by the menu functions.

Key Path	Source, Modulation Setup , ARB, Waveform Sequences, Build New Sequence
Notes	No remote command, SCPI front panel only. This key is grayed out and unavailable if the sequence is currently empty.
Initial S/W Revision	A.05.00

Insert New Waveform

Allows you access to the sub-menu for inserting a new waveform segment or sequence. Pressing this key also changes the central display to show the Waveform File Selection View.

Key Path	Source, Modulation Setup, ARB, Waveform Sequences, Build New Sequence
Notes	No remote command, SCPI front panel only. Waveform segment name string length upper limit is 128 chars. Please do NOT insert waveform which name string exceeds 128 chars.
Initial S/W Revision	A.05.00

Insert Waveform

Inserts the currently highlighted waveform to the end of the waveform sequence. Pressing this key also returns you to the menus for creating or editing a sequence, and returns the central view to the sequence creation view.

Key Path	Source, Modulation Setup, ARB, Waveform Sequences, Build New Sequence, Insert New Waveform
Notes	No remote command, SCPI front panel only. Waveform segment name string length upper limit is 128 chars. Please do NOT insert waveform which name string exceeds 128 chars.
Initial S/W Revision	A.05.00

Segments on Hard Disk

Allows you access to the sub-menus for loading waveform segments from the hard disk into ARB memory. The default directory is: D: varb.

Pressing this key changes the current view to the Waveform Management View.

Key Path	Source, Modulation Setup, ARB, Select Waveform
Initial S/W Revision	A.05.00

Load Segment To ARB Memory

Allows you to load the selected file into ARB memory. On the front panel you select the file for loading to the ARB memory by highlighting the desired file in the list. Using the SCPI command, you specify the file name on the HDD.

“NVWFM” (none-volatile storage) MSUS (Mass Storage Unit Specifier) is supported in the memory subsystem because the ARB memory cannot be accessed directly. Therefore, files must be downloaded to the instrument hard disk and then loaded into the ARB memory. “NVWFM” MSUS will be mapped to the default directory D: VARB. The SCPI command supports using either “NVWFM” MSUS or specifying a full path. For more information, see Memory Subsystem (Remote Command Only).

If a file of the same name already exists within ARB memory, it is overwritten. If you wish to load two segments of the same name, you must rename one of the segments before loading it into ARB memory. To rename a segment, you can either use Windows File Explorer, or the :MMEMory:COPI command.

NOTE: When a waveform file is loaded to ARB memory, burst timing adjustments are made automatically, based on whether or not a Multiport Adapter is connected to the test set and powered on. If the connection/power status of the Multiport Adapter is changed after a waveform file has been loaded, it needs to be loaded again.

Key Path	Source, Modulation Setup, ARB, Select Waveform, Segments on Hard Disk
Remote Command	:SOURce:RADio:ARB:LOAD <string>
Example	:SOUR:RAD:ARB:LOAD "D: VARB\testwaveform.bin" or :SOUR:RAD:ARB:LOAD "NVWFM:testwaveform.bin"
Notes	<p>Because loading the file involves a delay of unpredictable length, this command should be followed by the query *OPC?, which holds off subsequent commands until the loading operating is complete.</p> <p><string> – specifies the path name of the file to load from the HDD into ARB memory. It could be a <full path + filename>, or <“NVWFM” MSUS + colon + filename>.</p> <p>When in Sequence Analyzer mode, and Include Source is Yes, an attempt to load a file to ARB memory will be rejected with an error.</p> <p>When Include Source is No and if there is insufficient free ARB memory to load the selected waveform, an error is generated. .</p> <p>If you specify a file over SCPI, but the file is not at the specified location, an error is generated.</p> <p>If you try to load a waveform file but the file contains less than 500 IQ samples, an error is generated.</p> <p>If you try to load a Signal Studio waveform “*.wfm” which contains invalid waveform header, an error is generated.</p>

If the ARB is ON when you load a file to ARB memory or delete a file from ARB memory, the playing waveform segment may not keep phase continuity during the ARB memory operation. The waveform will be replayed after the ARB operation is finished.

ARB can be loaded into ARB memory even if required licenses do not present on the instrument. In this case, a GUI only warning message -800, "Operation complete; Loaded <filename> successfully, but no license <required licenses> installed". User can install required licenses according to <required licenses> string to license it, or multi-pack license it.

Initial S/W Revision	A.05.00
----------------------	---------

Load All To ARB Memory

Allows you to load all the segment files within the currently selected directory into ARB memory. If a file of the same name already exists within ARB memory, it is overwritten. If you wish to load two segments of the same name, you must rename one of the segments before loading it into ARB memory. To rename a segment, you can either use Windows File Explorer, or the :MEMory:COpy command.

NOTE: When a waveform file is loaded to ARB memory, burst timing adjustments are made automatically, based on whether or not a Multiport Adapter is connected to the test set and powered on. If the connection/power status of the Multiport Adapter is changed after a waveform file has been loaded, it needs to be loaded again.

Key Path	Source, Modulation Setup, ARB, Select Waveform, Segments on Hard Disk
----------	---

Remote Command	:SOURce:RADio:ARB:LOAD:ALL <string>
----------------	-------------------------------------

Example	:SOUR:RAD:ARB:LOAD:ALL "D: varb"
---------	----------------------------------

Notes	<p><string> - specifies the directory on the HDD to load the files into ARB memory from.</p> <p>When in Sequence Analyzer mode, and Include Source is Yes, an attempt to load all files from a directory to ARB memory is rejected with an error.</p> <p>When Include Source is No and there is insufficient free ARB memory to load all the waveforms, when the ARB memory is full, the copy ceases, and an error is generated.</p> <p>If you specify a directory over SCPI, but the directory does not exist, an error is generated.</p> <p>If the ARB is ON, a user then loads or deletes file to ARB memory, the playing waveform segment may not keep phase continuity during the ARB memory operation. The waveform will be replayed after the ARB operation is finished.</p>
-------	---

Initial S/W Revision	A.05.00
----------------------	---------

Change Directory...

Allows you to change the currently selected directory on the hard disk. Pressing this key opens a standard windows change directory dialog allowing you to select the new directory of interest.

The current directory is used for manually loading waveform segments into ARB memory for playback, and as a search location for waveform segments that are required to be loaded into ARB memory for playback of a waveform sequence or a list sequence.

Key Path	Source, Modulation Setup, ARB, Select Waveform, Segments on Hard Disk
Notes	No remote command, SCPI front panel only.
Initial S/W Revision	A.05.00

Default Directory...

Allows you to change the default directory. It is used as a search location for waveform segments that are required to be loaded into ARB memory for playback of a waveform sequence, and as a search location for selecting waveforms using SCPI.

Key Path	Source, Modulation Setup, ARB, Select Waveform, Segments on Hard Disk
Remote Command	:SOURce:RADio:ARB:DEFault:DIRectory <string> :SOURce:RADio:ARB: DEFault:DIRectory?
Example	:SOUR:RAD:ARB:DEF:DIR "D:\ArbFiles" :SOUR:RAD:ARB:DEF:DIR?
State Saved	Persistent, survives a power cycle and a preset but not saved in the instrument state
Initial S/W Revision	A.05.00

Segments in ARB Memory

Allows you access to the sub-menus for managing the files within ARB memory.

Key Path	Source, Modulation Setup, ARB, Select Waveform
Initial S/W Revision	A.05.00

Delete Segment From ARB Mem

Allows you to remove a segment from ARB playback memory.

Key Path	Source, Modulation Setup, ARB, Select Waveform, Segments in ARB Memory
Remote Command	:SOURce:RADio:ARB:DELete <string>
Example	:SOUR:RAD:ARB:DEL "testwaveform.bin"
Notes	<string> - specifies the waveform to be deleted from the ARB playback memory. When in Sequence Analyzer mode and Include Source is Yes, an attempt to delete a file from ARB memory is rejected with an error. When Include Source is No and you specify a file that does not exist within ARB memory, an error is generated. It is possible to delete files from within the ARB memory when the ARB is ON. However, if you attempt to delete the file that is currently playing an error is generated. It is possible to delete a file from within the ARB memory when the sequencer state is ON and the file is not being used by the List Sequencer. If you attempt to delete a file which is being used by the list

sequencer, an error is generated.

When sequencer state is On, even if ARB state is On, the selected waveform will not be played. In this case, if the selected waveform is not used in List Sequence, it can be deleted and the ARB state is turned Off.

If the ARB is ON and you load a file to ARB memory or delete a file from ARB memory, the playing waveform segment may not keep phase continuity during the ARB memory operation. The waveform will be replayed after the ARB operation is finished.

Initial S/W Revision A.05.00

Delete All From ARB Memory

Allows you to remove all segments from ARB playback memory.

Key Path	Source, Modulation Setup, ARB, Select Waveform, Segments in ARB Memory
Remote Command	:SOURce:RADio:ARB:DELeTe:ALL
Example	:SOUR:RAD:ARB:DELeTe:ALL
Notes	<p>When in Sequence Analyzer mode and Include Source is Yes, an attempt to delete all files from ARB memory is rejected with an error.</p> <p>When Include Source is No and you attempt to delete all files from ARB memory when the ARB is currently playing a file, all files except the one playing are deleted and an error is generated.</p> <p>If you attempt to delete all files from ARB memory when there are waveform files used in "List Sequencer" on page 2168 and "Sequencer" on page 2168 state is ON, all files except the files currently being used in list sequencer are deleted, and an error is generated.</p> <p>If the ARB is ON and you load a file to ARB memory or delete a file from ARB memory, the playing waveform segment may not keep phase continuity during the ARB memory operation. The waveform will be replayed after the ARB operation is finished.</p>

Initial S/W Revision A.05.00

Edit Selected Waveform

Allows access to the sub-menus for editing the details of the currently selected waveform segment.

Key Path	Source, Modulation Setup, ARB, Waveform Sequences, Build New Sequence
Notes	No remote command, front panel only.
Initial S/W Revision	A.05.00

Repetitions

Allows you to specify the number of times the currently selected waveform is played within the sequence.

Key Path	Source, Modulation Setup, ARB, Waveform Sequences, Build New Sequence, Edit Selected Waveform
-----------------	---

Notes	No remote command, SCPI front panel only.
Preset	1
Min	1
Max	65535
Initial S/W Revision	A.05.00

Marker 1

Allows you to enable or disable marker 1 for the currently selected waveform. For a waveform sequence, you can enable and disable markers on a per-segment basis, allowing you to output markers from some waveform segments within the sequence, but not for others.

Key Path	Source, Modulation Setup, ARB, Waveform Sequences, Build New Sequence, Edit Selected Waveform
Notes	No remote command, front panel only.
Preset	Enabled
Range	Enabled Disabled
Initial S/W Revision	A.05.00

Marker 2

Allows you to enable or disable marker 2 for the currently selected waveform. For a waveform sequence, you can enable and disable markers on a per-segment basis, allowing you to output markers from some waveform segments within the sequence, but not for others.

Key Path	Source, Modulation Setup, ARB, Waveform Sequences, Build New Sequence, Edit Selected Waveform
Notes	No remote command, front panel only.
Preset	Enabled
Range	Enabled Disabled
Initial S/W Revision	A.05.00

Marker 3

Allows you to enable or disable marker 3 for the currently selected waveform. For a waveform sequence, you can enable and disable markers on a per-segment basis, allowing you to output markers from some waveform segments within the sequence, but not for others.

Key Path	Source, Modulation Setup, ARB, Waveform Sequences, Build New Sequence, Edit Selected Waveform
----------	---

Notes	No remote command, front panel only.
Preset	Enabled
Range	Enabled Disabled
Initial S/W Revision	A.05.00

Marker 4

Allows you to enable or disable marker 4 for the currently selected waveform. For a waveform sequence, you can enable and disable markers on a per-segment basis, allowing you to output markers from some waveform segments within the sequence, but not for others.

Key Path	Source, Modulation Setup, ARB, Waveform Sequences, Build New Sequence, Edit Selected Waveform
Notes	No remote command, front panel only.
Preset	Enabled
Range	Enabled Disabled
Initial S/W Revision	A.05.00

Delete Segment

Allows you to delete the selected segment from the waveform sequence.

Key Path	Source, Modulation Setup, ARB, Waveform Sequences, Build New Sequence
Notes	No remote command, front panel only.
Initial S/W Revision	A.05.00

Save Sequence...

Pressing this key displays the “Save As” dialog. The sequence name is passed to the save as dialog to use as the filename for saving, and the directory the save as dialog will open into is the default waveform directory.

Key Path	Source, Modulation Setup, ARB, Waveform Sequences, Build New Sequence
Initial S/W Revision	A.05.00

Edit Selected Sequence

Allows access to the sub-menus for editing the sequence currently selected within the Waveform Sequence List view. Pressing this key changes the central view area to display the Waveform Sequence Creation and Editing view.

Key Path	Source, Modulation Setup, ARB, Waveform Sequences
Notes	No remote command, front panel only.
Initial S/W Revision	A.05.00

Current Directory...

Allows you to change the currently selected directory on the hard disk. Pressing this key opens a standard windows change directory dialog and allows you to select the new directory of interest.

Key Path	Source, Modulation Setup, ARB, Waveform Sequences
Notes	No remote command, front panel only.
Initial S/W Revision	A.05.00

Waveform Utilities

Allows you access to the waveform utilities sub-menus.

Key Path	Source, Modulation Setup, ARB
Initial S/W Revision	A.05.00

Multi-Pack Licenses

Allows you access to the Multi - Pack License sub-menus. Pressing this key also changes the central view area to display the Multi -Pack License Management view.

On modular instrument like E6630A or E6640A, multi-pack license operations are only allowed on the default module, i.e. “Left” module for E6630A or “TRX1” module for E6640A.

Key Path	Source, Modulation Setup, ARB, Waveform Utilities
Dependencies	This key is only available if there is at least one Multi-pack license installed on the instrument.
Initial S/W Revision	A.05.00

Add Waveform

Pressing this key accesses the Add Waveform sub-menu. It also changes the central display area to display the Multi-Pack License Waveform Add view.

Key Path	Source, Modulation Setup, ARB, Waveform Utilities, Multi-Pack Licenses
Dependencies	This key is only available if there is at least one slot available within at least one multi-pack license.
Initial S/W Revision	A.05.00

Add Waveform

Allows you to add the currently selected waveform segment to a multi-pack license. The new waveform is added to the next available slot regardless of which slot was selected on the Multi-Pack License Management view.

Key Path	Source, Modulation Setup, ARB, Waveform Utilities, Multi-Pack Licenses, Add Waveform
Remote Command	:SYSTem:LKEY:WAVeform:ADD <string> or :SYSTem:LICense[:FPACK]:WAVeform:ADD <string>
Example	SYST:LKEY:WAV:ADD "mywaveform.wfm" or SYST:LIC:WAV:ADD "mywaveform.wfm"
Notes	The second SCPI :SYSTem:LICense[:FPACK]:WAVeform:ADD is provided to be consistent with the style of Keysight signal sources. You can use either one of them. Since adding a waveform segment to a Multi-Pack license causes the license slot to enter the trial period of only 48 hours, pressing this key causes a confirmation dialog to be displayed to ensure you do want to add the waveform segment to the Multi-Pack. If you attempt to license a waveform that is already licensed using another slot an error is generated. .
Dependencies	This key is only available if the currently selected file is a secure waveform requiring a license, and there is at least one slot available within at least one multi-pack license. If the waveform highlighted is a secure waveform, but is already licensed, this key will be unavailable.
Initial S/W Revision	A.05.00

Segments on Hard Disk

Allows you access to the sub-menus for loading waveform segments from the hard disk into ARB memory. The default directory is: D: varb.

Pressing this key changes the current view to the Waveform Management View.

Key Path	Source, Modulation Setup, ARB, Select Waveform
Initial S/W Revision	A.05.00

Load Segment To ARB Memory

Allows you to load the selected file into ARB memory. On the front panel you select the file for loading to the ARB memory by highlighting the desired file in the list. Using the SCPI command, you specify the file name on the HDD.

"NVWFM" (none-volatile storage) MSUS (Mass Storage Unit Specifier) is supported in the memory subsystem because the ARB memory cannot be accessed directly. Therefore, files must be downloaded to the instrument hard disk and then loaded into the ARB memory. "NVWFM" MSUS will be mapped to the

default directory D: VARB. The SCPI command supports using either “NVWFM” MSUS or specifying a full path. For more information, see Memory Subsystem (Remote Command Only).

If a file of the same name already exists within ARB memory, it is overwritten. If you wish to load two segments of the same name, you must rename one of the segments before loading it into ARB memory. To rename a segment, you can either use Windows File Explorer, or the :MMEMory:COPI command.

NOTE: When a waveform file is loaded to ARB memory, burst timing adjustments are made automatically, based on whether or not a Multiport Adapter is connected to the test set and powered on. If the connection/power status of the Multiport Adapter is changed after a waveform file has been loaded, it needs to be loaded again.

Key Path	Source, Modulation Setup, ARB, Select Waveform, Segments on Hard Disk
Remote Command	:SOURce:RADio:ARB:LOAD <string>
Example	:SOUR:RAD:ARB:LOAD “D: VARB\testwaveform.bin” or :SOUR:RAD:ARB:LOAD “NVWFM:testwaveform.bin”
Notes	<p>Because loading the file involves a delay of unpredictable length, this command should be followed by the query *OPC?, which holds off subsequent commands until the loading operating is complete.</p> <p><string> – specifies the path name of the file to load from the HDD into ARB memory. It could be a <full path + filename>, or <“NVWFM” MSUS + colon + filename>.</p> <p>When in Sequence Analyzer mode, and Include Source is Yes, an attempt to load a file to ARB memory will be rejected with an error.</p> <p>When Include Source is No and if there is insufficient free ARB memory to load the selected waveform, an error is generated. .</p> <p>If you specify a file over SCPI, but the file is not at the specified location, an error is generated.</p> <p>If you try to load a waveform file but the file contains less than 500 IQ samples, an error is generated.</p> <p>If you try to load a Signal Studio waveform “*.wfm” which contains invalid waveform header, an error is generated.</p> <p>If the ARB is ON when you load a file to ARB memory or delete a file from ARB memory, the playing waveform segment may not keep phase continuity during the ARB memory operation. The waveform will be replayed after the ARB operation is finished.</p> <p>ARB can be loaded into ARB memory even required licenses do not present on the instrument. In this case, a GUI only warning message -800, “Operation complete; Loaded <filename> successfully, but no license <required licenses> installed”. User can install required licenses according to <required licenses> string to license it, or multi-pack license it.</p>
Initial S/W Revision	A.05.00

Load All To ARB Memory

Allows you to load all the segment files within the currently selected directory into ARB memory. If a file of the same name already exists within ARB memory, it is overwritten. If you wish to load two segments of the same name, you must rename one of the segments before loading it into ARB memory. To rename a segment, you can either use Windows File Explorer, or the :MEMory:COPI command.

NOTE: When a waveform file is loaded to ARB memory, burst timing adjustments are made automatically, based on whether or not a Multiport Adapter is connected to the test set and powered on. If the

connection/power status of the Multiport Adapter is changed after a waveform file has been loaded, it needs to be loaded again.

Key Path	Source, Modulation Setup, ARB, Select Waveform, Segments on Hard Disk
Remote Command	:SOURce:RADio:ARB:LOAD:ALL <string>
Example	:SOUR:RAD:ARB:LOAD:ALL "D: varb"
Notes	<p><string> - specifies the directory on the HDD to load the files into ARB memory from.</p> <p>When in Sequence Analyzer mode, and Include Source is Yes, an attempt to load all files from a directory to ARB memory is rejected with an error.</p> <p>When Include Source is No and there is insufficient free ARB memory to load all the waveforms, when the ARB memory is full, the copy ceases, and an error is generated.</p> <p>If you specify a directory over SCPI, but the directory does not exist, an error is generated.</p> <p>If the ARB is ON, a user then loads or deletes file to ARB memory, the playing waveform segment may not keep phase continuity during the ARB memory operation. The waveform will be replayed after the ARB operation is finished.</p>
Initial S/W Revision	A.05.00

Change Directory...

Allows you to change the currently selected directory on the hard disk. Pressing this key opens a standard windows change directory dialog allowing you to select the new directory of interest.

The current directory is used for manually loading waveform segments into ARB memory for playback, and as a search location for waveform segments that are required to be loaded into ARB memory for playback of a waveform sequence or a list sequence.

Key Path	Source, Modulation Setup, ARB, Select Waveform, Segments on Hard Disk
Notes	No remote command, SCPIfront panel only.
Initial S/W Revision	A.05.00

Default Directory...

Allows you to change the default directory. It is used as a search location for waveform segments that are required to be loaded into ARB memory for playback of a waveform sequence, and as a search location for selecting waveforms using SCPI.

Key Path	Source, Modulation Setup, ARB, Select Waveform, Segments on Hard Disk
Remote Command	:SOURce:RADio:ARB:DEFault:DIRectory <string> :SOURce:RADio:ARB: DEFault:DIRectory?
Example	:SOUR:RAD:ARB:DEF:DIR "D:\ArbFiles" :SOUR:RAD:ARB:DEF:DIR?
State Saved	Persistent, survives a power cycle and a preset but not saved in the instrument state
Initial S/W Revision	A.05.00

Replace Waveform

Pressing this key accesses the Replace Waveform submenu. It also changes the central display area to display the Multi-Pack License Waveform Add view.

Key Path	Source, Modulation Setup, ARB, Waveform Utilities, Multi-Pack Licenses
Dependencies	This key is only available if the currently selected slot is in the trial state.
Initial S/W Revision	A.05.00

Replace Waveform

Allows you to replace the waveform in the currently selected slot with the waveform currently selected in the Multi-Pack License Waveform Add view.

Key Path	Source, Modulation Setup, ARB, Waveform Utilities, Multi-Pack Licenses, Replace Waveform
Remote Command	:SYSTem:LKEY:WAVeform:REPLace <int>, <string> or :SYSTem:LIcense[:FPACK]:WAVeform:REPLace <int>, <string>
Example	SYST:LKEY:WAV:REPL 1, "myotherwaveform.wfm" or :SYST:LIC:WAV:REPL 1, "myotherwaveform.wfm"
Notes	The second SCPI :SYSTem:LIcense[:FPACK]:WAVeform:REPLace is provided to be consistent with the style of Keysight signal sources. You can use either one of them. If you attempt to license a waveform that is already licensed using another slot an error is generated. Waveform slot number <int> is positive. If you attempt to input a slot number less than or equals 0, an error is generated.
Initial S/W Revision	A.05.00

Clear Waveform from Slot

Allows you to clear the waveform from the selected slot.

Key Path	Source, Modulation Setup, ARB, Waveform Utilities, Multi-Pack Licenses
Remote Command	:SYSTem:LKEY:WAVeform:CLEar <int> or :SYSTem:LIcense[:FPACK]:WAVeform:CLEar <int>
Example	SYST:LKEY:WAV:CLE 1 or :SYST:LIC:WAV:CLE 1
Notes	The second SCPI :SYSTem:LIcense[:FPACK]:WAVeform:CLEar is provided to be consistent with the style of Keysight signal sources. You can use either one of them. Waveform slot number <int> is positive. If you attempt to input a slot number less than or equals 0, an

error is generated.

Dependencies	This key is only available if the currently selected slot is in the trial state.
Initial S/W Revision	A.05.00

Lock Waveform in Slot

If the selected slot is in the trial state or the lock required state, the waveform that occupies the slot is locked and permanently licensed.

Key Path	Source, Modulation Setup, ARB, Waveform Utilities, Multi-Pack Licenses
Remote Command	:SYSTem:LKEY:WAVeform:LOCK <int> or :SYSTem:LICense[:FPACK]:WAVeform:LOCK <int>
Example	SYST:LKEY:WAV:LOCK 1 or SYST:LIC:WAV:LOCK 1
Notes	The second SCPI :SYSTem:LICense[:FPACK]:WAVeform:LOCK is provided to be consistent with the style of Keysight signal sources. You can use either one of them. Waveform slot number <int> is positive. If you attempt to input a slot number less than or equals 0, an error is generated.
Dependencies	This key is only available if the currently selected slot is in the trial state or the lock required state.
Initial S/W Revision	A.05.00

Marker Utilities

Allows access to the marker utilities sub-menus.

Key Path	Source, Modulation Setup, ARB
Initial S/W Revision	A.05.00

Marker Polarity

Allows access to the marker polarity sub-menu, which allows you to specify the polarity for the four markers. For a positive polarity, the marker signal is high during the marker points. For a negative marker polarity, the marker signal is high during the period of no marker points.

Key Path	Source, Modulation Setup, ARB, Marker Utilities
Initial S/W Revision	A.05.00

Mkr 1 Polarity

Allows you to set the polarity of marker 1.

Key Path	Source, Modulation Setup, ARB, Marker Utilities, Marker Polarity
Remote Command	:SOURce:RADio:ARB:MPOLarity:MARKer1 POSitive NEGative :SOURce:RADio:ARB:MPOLarity:MARKer1?
Example	:SOUR:RAD:ARB:MPOL:MARK1 NEG
Dependencies	When a new waveform is selected for playback the settings contained within the associated waveform header file are applied to the ARB. The marker polarity is one of the values stored within the header file. If the newly selected waveform file has an associated header file, the marker polarity is updated with the value from the header file. The marker polarity will remain unchanged if the newly selected waveform does not have an associated header file.
Preset	Pos
Range	Neg Pos
Initial S/W Revision	A.05.00

Mkr 2 Polarity

Allows you to set the polarity of marker 2.

Key Path	Source, Modulation Setup, ARB, Marker Utilities, Marker Polarity
Remote Command	:SOURce:RADio:ARB:MPOLarity:MARKer2 POSitive NEGative :SOURce:RADio:ARB:MPOLarity:MARKer2?
Example	:SOUR:RAD:ARB:MPOL:MARK2 NEG
Dependencies	When a new waveform is selected for playback the settings contained within the associated waveform header file are applied to the ARB. The marker polarity is one of the values stored within the header file. If the newly selected waveform file has an associated header file, the marker polarity is updated with the value from the header file. The marker polarity will remain unchanged if the newly selected waveform does not have an associated header file.
Preset	Pos
Range	Neg Pos
Initial S/W Revision	A.05.00

Mkr 3 Polarity

Allows you to set the polarity of marker 3.

Key Path	Source, Modulation Setup, ARB, Marker Utilities, Marker Polarity
Remote Command	:SOURce:RADio:ARB:MPOLarity:MARKer3 POSitive NEGative :SOURce:RADio:ARB:MPOLarity:MARKer3?
Example	:SOUR:RAD:ARB:MPOL:MARK3 NEG
Dependencies	When a new waveform is selected for playback the settings contained within the associated

	waveform header file are applied to the ARB. The marker polarity is one of the values stored within the header file. If the newly selected waveform file has an associated header file, the marker polarity is updated with the value from the header file. The marker polarity will remain unchanged if the newly selected waveform does not have an associated header file.
Preset	Pos
Range	Neg Pos
Initial S/W Revision	A.05.00

Mkr 4 Polarity

Allows you to set the polarity of marker 4.

Key Path	Source, Modulation Setup, ARB, Marker Utilities, Marker Polarity
Remote Command	:SOURce:RADio:ARB:MPOLarity:MARKer4 POSitive NEGative :SOURce:RADio:ARB:MPOLarity:MARKer4?
Example	:SOUR:RAD:ARB:MPOL:MARK4 NEG
Dependencies	When a new waveform is selected for playback the settings contained within the associated waveform header file are applied to the ARB. The marker polarity is one of the values stored within the header file. If the newly selected waveform file has an associated header file, the marker polarity is updated with the value from the header file. The marker polarity will remain unchanged if the newly selected waveform does not have an associated header file.
Preset	Pos
Range	Neg Pos
Initial S/W Revision	A.05.00

Marker Routing

Allows access to the marker routing sub-menus, which allow you to specify where the marker events are routed. It should be noted that the markers can also be routed to Trigger 1 Out and Trigger 2 Out, however this must be set up using the menus accessed by pressing the “Trigger” hard key.

Key Path	Source, Modulation Setup, ARB, Marker Utilities
Initial S/W Revision	A.05.00

Pulse/RF Blank

Allows you to select which marker is used for the pulse/RF blanking function. The pulse/RF blanking function blanks the RF when the marker signal goes low. The marker polarity determines when the marker signal is high. For a positive polarity, this is during the marker points. For a negative polarity, this is when there are no marker points.

Marker points should be set before using this function. Enabling this function without setting marker points may create a continuous low or high signal, dependant on the marker polarity. This causes either no RF output, or a continuous RF output.

Key Path	Source, Modulation Setup, ARB, Marker Utilities, Marker Routing
Remote Command	:SOURce:RADio:ARB:MDEStination:PULSe NONE M1 M2 M3 M4 :SOURce:RADio:ARB:MDEStination:PULSe?
Example	:SOUR:RAD:ARB:MDES:PULS NONE
Dependencies	When a new waveform is selected for playback the settings contained within the associated waveform header file are applied to the ARB. The pulse/RF blanking setting is one of the values stored within the header file. If the newly selected waveform file has an associated header file, the pulse/RF blanking setting is updated with the value from the header file. The pulse/RF blanking setting will remain unchanged if the newly selected waveform does not have an associated header file.
Range	None M1 M2 M3 M4
Initial S/W Revision	A.05.00

None

Sets no marker to be used for the pulse/RF blanking function, essentially turning the RF blanking function off.

Key Path	Source, Modulation Setup, ARB, Marker Utilities, Marker Routing, Pulse/RF Blank
Example	:SOUR:RAD:ARB:MDES:PULS NONE
Initial S/W Revision	A.05.00

Marker 1

Sets marker 1 to be used for the pulse/RF blanking function.

Key Path	Source, Modulation Setup, ARB, Marker Utilities, Marker Routing, Pulse/RF Blank
Example	:SOUR:RAD:ARB:MDES:PULS M1
Initial S/W Revision	A.05.00

Marker 2

Sets marker 2 to be used for the pulse/RF blanking function.

Key Path	Source, Modulation Setup, ARB, Marker Utilities, Marker Routing, Pulse/RF Blank
Example	:SOUR:RAD:ARB:MDES:PULS M2
Initial S/W Revision	A.05.00

Marker 3

Sets marker 3 to be used for the pulse/RF blanking function.

Key Path	Source, Modulation Setup, ARB, Marker Utilities, Marker Routing, Pulse/RF Blank
Example	:SOUR:RAD:ARB:MDES:PULS M3
Initial S/W Revision	A.05.00

Marker 4

Sets marker 4 to be used for the pulse/RF blanking function.

Key Path	Source, Modulation Setup, ARB, Marker Utilities, Marker Routing, Pulse/RF Blank
Example	:SOUR:RAD:ARB:MDES:PULS M4
Initial S/W Revision	A.05.00

ALC Hold

Allows you to specify which marker is routed for use within the ALC hold function. The ALC hold marker function holds the ALC circuitry at the average value of the sample points set by the marker.

The ALC hold function operates during the low periods of the marker signal. The marker polarity determines when the marker signal is high. For positive polarity, this is during the marker points. For a negative polarity, this is when there are no marker points.

Key Path	Source, Modulation Setup, ARB, Marker Utilities, Marker Routing
Remote Command	:SOURce:RADio:ARB:MDEStination:ALCHold NONE M1 M2 M3 M4 :SOURce:RADio:ARB:MDEStination:ALCHold?
Example	:SOUR:RAD:ARB:MDES:ALCH NONE
Dependencies	When a new waveform is selected for playback the settings contained within the associated waveform header file are applied to the ARB. The ALC hold setting is one of the values stored within the header file. If the newly selected waveform file has an associated header file, the ALC hold setting is updated with the value from the header file. The ALC hold setting will remain unchanged if the newly selected waveform does not have an associated header file.
Range	None M1 M2 M3 M4
Initial S/W Revision	A.05.00

None

Sets no marker to be used for the ALC hold function, essentially turning the ALC hold function off.

Key Path	Source, Modulation Setup, ARB, Marker Utilities, Marker Routing, ALC Hold
Example	:SOUR:RAD:ARB:MDES:PULS NONE
Initial S/W Revision	A.05.00

Marker 1

Sets marker 1 to be used for the ALC hold function.

Key Path	Source, Modulation Setup, ARB, Marker Utilities, Marker Routing, ALC Hold
Example	:SOUR:RAD:ARB:MDES:PULS M1
Initial S/W Revision	A.05.00

Marker 2

Sets marker 2 to be used for the ALC hold function.

Key Path	Source, Modulation Setup, ARB, Marker Utilities, Marker Routing, ALC Hold
Example	:SOUR:RAD:ARB:MDES:PULS M2
Initial S/W Revision	A.05.00

Marker 3

Sets marker 3 to be used for the ALC hold function.

Key Path	Source, Modulation Setup, ARB, Marker Utilities, Marker Routing, ALC Hold
Example	:SOUR:RAD:ARB:MDES:PULS M3
Initial S/W Revision	A.05.00

Marker 4

Sets marker 4 to be used for the ALC hold function.

Key Path	Source, Modulation Setup, ARB, Marker Utilities, Marker Routing, ALC Hold
Example	:SOUR:RAD:ARB:MDES:PULS M4
Initial S/W Revision	A.05.00

Header Utilities

Allows access to the header utilities sub-menu. Pressing this key also causes the central display area to change to display the File Header Information view.

Key Path	Source, Modulation Setup, ARB
Dependencies	This key is only available if there is currently a waveform selected for playback. If no waveform is selected, the key is grayed out.
Initial S/W Revision	A.05.00

Clear Header

Allows you to clear the header information from the file header associated with the currently selected waveform.

Key Path	Source, Modulation Setup, ARB, Header Utilities
Remote Command	:SOURce:RADio:ARB:HEADer:CLEar
Example	:SOUR:RAD:ARB:HEAD:CLE
Notes	Attempting to clear the header details via SCPI when no waveform was selected for playback will generate an error.
Initial S/W Revision	A.05.00

Save Setup To Header

Allows you to save new file header information details to the file.

Key Path	Source, Modulation Setup, ARB, Header Utilities
Remote Command	:SOURce:RADio:ARB:HEADer:SAVE
Example	:SOUR:RAD:ARB:HEAD:SAVE
Notes	Attempting to save the header details via SCPI when no waveform was selected for playback will generate an error.
Initial S/W Revision	A.05.00

AM

Allows access to the menu for configuring the Amplitude Modulation.

Key Path	Source, Modulation Setup
Initial S/W Revision	A.05.00

AM

Enables or disables the amplitude modulation.

Turning AM on when another modulation format is already on results in the previous modulation format being turned off and the generation of an error.

Key Path	Source, Modulation Setup, AM
Remote Command	:SOURce:AM:STATe :SOURce:AM:STATe?
Example	:SOUR:AM:STAT OFF

Preset	Off
Range	On Off
Initial S/W Revision	A.05.00

AM Depth

Allows you to set the amplitude modulation depth in percent.

Key Path	Source, Modulation Setup, AM
Remote Command	:SOURce:AM[:DEPTh] [:LINear] :SOURce:AM[:DEPTh] [:LINear]?
Example	:SOUR:AM 0.1
Preset	0.1 %
Min	0.1 %
Max	95.0 %
Initial S/W Revision	A.05.00

AM Rate

Allows you to set the internal amplitude modulation rate.

Key Path	Source, Modulation Setup, AM
Remote Command	:SOURce:AM:INTernal:FREQuency :SOURce:AM:INTernal:FREQuency?
Example	:SOUR:AM:INT:FREQ 40.0 Hz
Preset	400.0 Hz
Min	10 Hz
Max	40 kHz
Initial S/W Revision	A.05.00

FM

Allows access to the menu for configuring the frequency modulation.

Key Path	Source, Modulation Setup
Initial S/W Revision	A.05.00

FM

Enables or disables the frequency modulation.

Turning FM on when another modulation format is already on results in the previous modulation format being turned off and the generation of an error.

Key Path	Source, Modulation Setup, FM
Remote Command	:SOURce:FM:STATe :SOURce:FM:STATe?
Example	:SOUR:FM:STAT OFF
Preset	Off
Range	On Off
Initial S/W Revision	A.05.00

FM Deviation

Allows you to set the frequency modulation deviation.

Key Path	Source, Modulation Setup, FM
Remote Command	:SOURce:FM[:DEVIation] :SOURce:FM[:DEVIation]?
Example	:SOUR:FM 1.00 kHz
Preset	1.00 Hz
Min	1.00 Hz
Max	100.00 kHz
Initial S/W Revision	A.05.00

FM Rate

Allows you to set the internal frequency modulation rate.

Key Path	Source, Modulation Setup, FM
Remote Command	:SOURce:FM:INTernal:FREQuency :SOURce:FM:INTernal:FREQuency?
Example	:SOUR:FM:INT:FREQ 40.0 Hz
Preset	400.0 Hz
Min	10 Hz
Max	40 kHz
Initial S/W Revision	A.05.00

PM

Allows access to the menu for configuring the phase modulation.

Key Path	Source, Modulation Setup
Initial S/W Revision	A.05.00

PM

Enables or disables the phase modulation.

Turning PM on when another modulation format is already on results in the previous modulation format being turned off and the generation of an error.

Key Path	Source, Modulation Setup, PM
Remote Command	:SOURce:PM:STATe :SOURce:PM:STATe?
Example	:SOUR:PM:STAT OFF
Preset	Off
Range	On Off
Initial S/W Revision	A.05.00

PM Deviation

Allows you to set the phase modulation deviation.

Key Path	Source, Modulation Setup, PM
Remote Command	:SOURce:PM[:DEViation] :SOURce:PM[:DEViation]?
Example	:SOUR:PM 1.00 rad
Preset	0.1 rad
Min	0.1 rad
Max	20.0 rad
Initial S/W Revision	A.05.00

PM Rate

Allows you to set the internal phase modulation rate.

Key Path	Source, Modulation Setup, PM
Remote Command	:SOURce:PM:INTernal:FREQuency :SOURce:PM:INTernal:FREQuency?

Example	:SOUR:PM:INT:FREQ 40.0 Hz
Preset	400.0 Hz
Min	10 Hz
Max	40 kHz
Initial S/W Revision	A.05.00

List Sequencer

Allows you access to the sub-menus for configuring the list sequencer.

List sequences allows you to enter frequencies and amplitudes at unequal intervals in nonlinear ascending, descending or random order. Each step within the list can also include its own waveform file for playback, step duration, trigger event and trigger output.

The complexities involved in configuring the list sequencer do not lend itself to manual configuration; hence the manual configuration for this feature is limited. For easier configuration of the list sequencer, it is recommended that you use either SCPI or load a tab delimited file containing the setup parameters in a tabular form. The details of the SCPI for configuring the list sequencer can be found in Step Configuration (Remote Command Only).

Once the List Sequencer has been configured using the front panel, SCPI, or loading in a tab delimited file, the sequence must be initiated using the front panel Initiate Sequence key or the corresponding SCPI command.

Key Path	Source
Initial S/W Revision	A.05.00

Sequencer

Allows you to set the state of the list sequencer. When the list sequencer is on, the source is outputting the sequence defined by the sequencer. When the list sequencer is off, the source outputs a single waveform segment or sequence (independent mode) at a single frequency and amplitude.

Key Path	Source, List Sequencer
Remote Command	:SOURce:LIST[:STATe] ON OFF 1 0 :SOURce:LIST[:STATe]?
Example	:SOUR:LIST OFF
Notes	When the sequencer is set to ON, the list sequencer controls the output of the source.
Couplings	When in Sequence Analyzer mode and the list sequencer state is Off, Include Source is forced to No, and the Include Source key is grayed out. When in Sequence Analyzer mode and the list sequencer state is On, Include Source is available to set. And, an ARB memory related operation, like load or delete will be rejected.

Preset	Off
Range	On Off
Initial S/W Revision	A.05.00

Initiate Sequence

Pressing this key arms the sequence for single execution. Once the sequence is armed the source begins the sequence as soon as the trigger is received. If the trigger is set to Free Run, the sequence starts immediately.

Key Path	Source, List Sequencer
Remote Command	:SOURce:LIST:TRIGger[:IMMediate]
Example	:SOUR:LIST:TRIG
Notes	<p>When in Sequence Analyzer mode and Include Source is Yes, the Initiate list sequencer operation is rejected, and the key is grayed out, since source list sequence request is sent to physics via Parallel batch by sequence analyzer.</p> <p>If the file needed by the sequencer is not already in ARB memory, the sequence cannot be initiated and an error will be generated.</p> <p>There is a blocking SCPI query which can be used to query if source list sequence being initiated successfully or not. (see Query List Sequence Initiation Armed Status (Remote Command Only) Query Source List Sequence Armed Status)</p>
Dependencies	Under the Sequence Analyzer Mode, if Meas Setup->Include Source is set to YES, Source->List Sequencer->Initiate Sequence is disabled.
Initial S/W Revision	A.05.00

List Sequencer Setup

Allows you access to the list sequencer setup menus.

Key Path	Source, List Sequencer
----------	------------------------

Number of Steps

Allows you to specify the number of steps within the list sequence.

Key Path	Source, List Sequencer, List Sequencer Setup
Remote Command	:SOURce:LIST:NUMBer:STEPs <integer> :SOURce:LIST:NUMBer:STEPs?
Example	:SOUR:LIST:NUMB:STEP 1
Notes	Increasing the number of steps creates additional steps at the end of the list, with all the settings

	within the steps set to their default values. Decreasing the number of steps removes steps from the end of the list. The settings within the removed steps are not reset. This means that increasing the number of steps again would allow you to retrieve these steps.
Dependencies	The Step Count parameter is increased or decreased when you insert or delete a point from within the GUI interface to the sequencer.
Preset	1
Min	1
Max	1000
Initial S/W Revision	A.05.00

Current Step

Allows you to select the step number you wish to view or edit.

Key Path	Source, List Sequencer, List Sequencer Setup
Notes	No remote command, front panel only.
Preset	1
Min	1
Max	Step Count
Initial S/W Revision	A.05.00

Insert Step Before

Allows you to insert a new step, containing default values, before the currently selected step. Inserting a step will automatically increase the Step Count parameter by 1. If sequence already reaches upper limit of 1000 steps, then insert more step will be rejected and popup error –221, “Setting Conflict; Cannot insert more steps, maximum number of steps reached”

Key Path	Source, List Sequencer, List Sequencer Setup
Notes	No remote command, front panel only. If the list already contains the maximum limit of 1000 steps, no operation will be made after pressing this key.
Initial S/W Revision	A.05.00

Delete Step

Allows you to delete the current step. Deleting a step will automatically decrease the Step Count parameter by 1. If sequence only has one step left, delete step will be rejected and popup error –221, “Setting conflict; Cannot delete current step, minimum number of steps reached”

Key Path	Source, List Sequencer, List Sequencer Setup
Notes	No remote command, Front Panel key only. If the list already contains the minimum limit of 1 step, no operation will be made after pressing this key
Initial S/W Revision	A.05.00

Clear List

Allows you to clear the list. Clearing the list sets the number of steps to the default value of 1 and sets the parameters for the only step to their default values.

Key Path	Source, List Sequencer, List Sequencer Setup
Initial S/W Revision	A.05.00

Step Trigger

Allows access to the sub-menu for selecting the trigger input for the current step.

Key Path	Source, List Sequencer, List Sequencer Setup
Remote Command	:SOURce:LIST:STEP[1] 2 3...1000:SETup:INPut:TRIGger IMMEDIATE INTERNAL EXTERNAL2 KEY BUS EXTERNAL4 :SOURce:LIST:STEP[1] 2 3...1000:SETup:INPut:TRIGger?
Example	:SOUR:LIST:STEP2:SET:INP:TRIG BUS :SOUR:LIST:STEP2:SET:INP:TRIG?
Notes	SCPI is supported after A.09.40
Preset	Free Run
Range	Free Run Internal Manual (Trigger Key) Bus External 2 EXTERNAL4
Initial S/W Revision	A.05.00

Free Run

Sets the trigger input for the current step to Free Run.

Key Path	Source, List Sequencer, List Sequencer Setup, Step Trigger
Example	:SOUR:LIST:STEP2:SET:INP:TRIG IMM
Notes	SCPI is supported after A.09.40
Initial S/W Revision	A.05.00

Internal

Sets the trigger input for the current step to Internal.

Key Path	Source, List Sequencer, List Sequencer Setup, Step Trigger
Example	:SOUR:LIST:STEP2:SET:INP:TRIG INT
Notes	SCPI is supported after A.09.40
Initial S/W Revision	A.05.00

Manual (Trigger Key)

Sets the trigger input for the current step to Manual (Trigger Key). Any step in the sequence set to Manual will cause the sequence execution to stop until the manual trigger key is pressed. Sending the Bus Trigger SCPI command will have no effect. At any point in the sequence where the list sequencer is paused waiting for a software trigger, a pop up dialog is displayed until the trigger event occurs.

Key Path	Source, List Sequencer, List Sequencer Setup, Step Trigger
Example	:SOUR:LIST:STEP2:SET:INP:TRIG KEY
Notes	SCPI is supported after A.09.40
Initial S/W Revision	A.05.00

Bus

Sets the trigger input for the current step to Bus. Any step in the sequence set to Bus will cause the sequence execution to stop until the Bus Trigger SCPI command is sent. Pressing the manual trigger key has no effect. At any point in the sequence where the list sequencer is paused waiting for a software trigger, a pop up dialog is displayed until the trigger event occurs.

Key Path	Source, List Sequencer, List Sequencer Setup, Step Trigger
Example	:SOUR:LIST:STEP2:SET:INP:TRIG BUS
Notes	SCPI is supported after A.09.40
Initial S/W Revision	A.05.00

External 2

Sets the trigger input for the current step to External 2.

Key Path	Source, List Sequencer, List Sequencer Setup, Step Trigger
Example	:SOUR:LIST:STEP2:SET:INP:TRIG EXT2
Notes	SCPI is supported after A.09.40
Notes	Note: When on E6640A, trigger 2 is a bi-directional trigger port. So when trigger 2 has been configured as OUTPUT type, choosing External 2 as the input trigger for the current step will generate error.
Initial S/W Revision	A.05.00

Transition Time

Allows you to specify the transition time for the current step.

The transition time is the amount of time allowed for the source to settle at the current frequency or amplitude value.

Transition Time should not be taken as additional time before or inside the Step Duration. You can set a value for the settling time to allow the source output frequency or amplitude to become stable. Make sure that during this period of time, you do not use the source output signal.

The following table lists recommended values for appropriate settling times to allow for changes within the source.

Value Changed	Recommended Transition Time
Frequency	500 μ s
Amplitude	100 μ s to within 0.1 dB 20 μ s to within 1.0 dB

If the Transition Time value is shorter than the time necessary for the hardware to settle and a List Sequence is initiated, a **warning** is generated.

If the Transition Time value is longer than the Step Duration, an error is generated when initiating a source list sequence. For source list sequence, transition time is included in the step duration length. If the Transition Time value is longer than the Step Duration Time, the real step duration length is extended to equal the transition time and cause a timing shift.

Key Path	Source, List Sequencer, List Sequencer Setup
Remote Command	:SOURce:LIST:STEP[1] 2 3...1000:SETup:TRANSition:TIME <time> :SOURce:LIST:STEP[1] 2 3...1000:SETup:TRANSition:TIME?
Example	:SOUR:LIST:STEP2:SET:TRAN:TIME 1ms :SOUR:LIST:STEP2:SET:TRAN:TIME?
Notes	SCPI is supported after A.09.40
Preset	1.0 ms
Min	0.0 ms
Max	4.0 ks
Initial S/W Revision	A.05.00

Radio Setup

Allows you access to the sub-menus for setting up the radio standard, band, and radio band link direction for the current step.

Key Path	Source, List Sequencer, List Sequencer Setup
Notes	No remote command, front panel only.

Initial S/W Revision	A.05.00
----------------------	---------

Radio Standard

Allows access to the sub-menus for selecting the radio standard and the associated radio band for use in the current step.

Key Path	Source, List Sequencer, List Sequencer Setup, Radio Setup
Remote Command	:SOURce:LIST:STEP[1] 2 3...1000:SETup:RADio:BAND NONE PGSM EGSM RGSM DCS1800 PCS1900 TGSM810 GSM450 GSM480 GSM700 GSM850 BANDI BANDII BANDIII BANDIV BANDV BANDVI BANDVII BANDVIII BANDIX BANDX BANDXI BANDXII BANDXIII BANDXIV BANDXIX USCELL USPCS JAPAN KOREAN NMT IMT2K UPPER SECOND PAMR400 PAMR800 IMTEXT PCS1DOT9G AWS US2DOT5G PUBLIC LOWER NONE BAND1 BAND2 BAND3 BAND4 BAND5 BAND6 BAND7 BAND8 BAND10 BAND11 BAND12 BAND13 BAND14 BAND17 BAND18 BAND19 BAND20 BAND21 BAND24 BAND25 BAND26 BAND27 BAND28 BAND29 BAND30 BAND31 BAND33 BAND34 BAND35 BAND36 BAND37 BAND38 BAND39 BAND40 BAND41 BAND42 BAND43 BAND44 BANDA BANDB BANDC BANDD BANDE BANDF :SOURce:LIST:STEP[1] 2 3...1000:SETup: RADio:BAND?
Example	:SOUR:LIST:STEP2:SET:RAD:BAND PGSM :SOUR:LIST:STEP2:SET:RAD:BAND?
Notes	SCPI is supported after A.09.40
Initial S/W Revision	A.05.00

None

Selects no radio standard for use on the current step.

Key Path	Source, List Sequencer, List Sequencer Setup, Radio Setup, Radio Standard
Example	:SOUR:LIST:STEP2:SET:RAD:BAND NONE
Notes	SCPI is supported after A.09.40
Initial S/W Revision	A.05.00

GSM/EDGE

Pressing this key once selects GSM/EDGE as the radio standard and the current GSM/EDGE band as the active channel band. Pressing this key again allows access to the sub-menus for selecting a different GSM/EDGE band.

Key Path	Source, List Sequencer, List Sequencer Setup, Radio Setup, Radio Standard
Initial S/W Revision	A.05.00

P-GSM

Selects P-GSM as the band for the current step.

Key Path	Source, List Sequencer, List Sequencer Setup, Radio Setup, Radio Standard, GSM/EDGE
Initial S/W Revision	A.05.00

E-GSM

Selects E-GSM as the band for the current step.

Key Path	Source, List Sequencer, List Sequencer Setup, Radio Setup, Radio Standard, GSM/EDGE
Initial S/W Revision	A.05.00

R-GSM

Selects R-GSM as the band for the current step.

Key Path	Source, List Sequencer, List Sequencer Setup, Radio Setup, Radio Standard, GSM/EDGE
Initial S/W Revision	A.05.00

DCS 1800

Selects DCS 1800 as the band for the current step.

Key Path	Source, List Sequencer, List Sequencer Setup, Radio Setup, Radio Standard, GSM/EDGE
Initial S/W Revision	A.05.00

PCS 1900

Selects PCS 1900 as the band for the current step.

Key Path	Source, List Sequencer, List Sequencer Setup, Radio Setup, Radio Standard, GSM/EDGE
Initial S/W Revision	A.05.00

GSM 450

Selects GSM 450 as the band for the current step.

Key Path	Source, List Sequencer, List Sequencer Setup, Radio Setup, Radio Standard, GSM/EDGE
Initial S/W Revision	A.05.00

GSM 480

Selects GSM 480 as the band for the current step.

Key Path	Source, List Sequencer, List Sequencer Setup, Radio Setup, Radio Standard, GSM/EDGE
Initial S/W Revision	A.05.00

GSM 850

Selects GSM 850 as the band for the current step.

Key Path	Source, List Sequencer, List Sequencer Setup, Radio Setup, Radio Standard, GSM/EDGE
Initial S/W Revision	A.05.00

GSM 700

Selects GSM 700 as the band for the current step.

Key Path	Source, List Sequencer, List Sequencer Setup, Radio Setup, Radio Standard, GSM/EDGE
Initial S/W Revision	A.05.00

T-GSM 810

Selects T-GSM 810 as the band for the current step.

Key Path	Source, List Sequencer, List Sequencer Setup, Radio Setup, Radio Standard, GSM/EDGE
Initial S/W Revision	A.05.00

WCDMA

Pressing this key once selects WCDMA as the radio standard and the current WCDMA band as the active channel band. Pressing this key again allows access to the sub-menus for selecting a different WCDMA band.

Key Path	Source, List Sequencer, List Sequencer Setup, Radio Setup, Radio Standard
Initial S/W Revision	A.05.00

Band I

Selects Band I as the band for the current step.

Key Path	Source, List Sequencer, List Sequencer Setup, Radio Setup, Radio Standard, WCDMA
Initial S/W Revision	A.05.00

Band II

Selects Band II as the band for the current step.

Key Path	Source, List Sequencer, List Sequencer Setup, Radio Setup, Radio Standard, WCDMA
Initial S/W Revision	A.05.00

Band III

Selects Band III as the band for the current step.

Key Path	Source, List Sequencer, List Sequencer Setup, Radio Setup, Radio Standard, WCDMA
Initial S/W Revision	A.05.00

Band IV

Selects Band IV as the band for the current step.

Key Path	Source, List Sequencer, List Sequencer Setup, Radio Setup, Radio Standard, WCDMA
Initial S/W Revision	A.05.00

Band V

Selects Band V as the band for the current step.

Key Path	Source, List Sequencer, List Sequencer Setup, Radio Setup, Radio Standard, WCDMA
Initial S/W Revision	A.05.00

Band VI

Selects Band VI as the band for the current step.

Key Path	Source, List Sequencer, List Sequencer Setup, Radio Setup, Radio Standard, WCDMA
Initial S/W Revision	A.05.00

Band VII

Selects Band VII as the band for the current step.

Key Path	Source, List Sequencer, List Sequencer Setup, Radio Setup, Radio Standard, WCDMA
Initial S/W Revision	A.05.00

Band VIII

Selects Band VIII as the band for the current step.

Key Path	Source, List Sequencer, List Sequencer Setup, Radio Setup, Radio Standard, WCDMA
Initial S/W Revision	A.05.00

Band IX

Selects Band IX as the band for the current step.

Key Path	Source, List Sequencer, List Sequencer Setup, Radio Setup, Radio Standard, WCDMA
Initial S/W Revision	A.05.00

Band X

Selects Band X as the band for the current step.

Key Path	Source, List Sequencer, List Sequencer Setup, Radio Setup, Radio Standard, WCDMA
Initial S/W Revision	A.05.00

Band XI

Selects Band XI as the band for the current step.

Key Path	Source, List Sequencer, List Sequencer Setup, Radio Setup, Radio Standard, WCDMA
Initial S/W Revision	A.05.00

Band XII

Selects Band XII as the band for the current step.

Key Path	Source, List Sequencer, List Sequencer Setup, Radio Setup, Radio Standard, WCDMA
Initial S/W Revision	A.05.00

Band XIII

Selects Band XIII as the band for the current step.

Key Path	Source, List Sequencer, List Sequencer Setup, Radio Setup, Radio Standard, WCDMA
Initial S/W Revision	A.05.00

Band XIV

Selects Band XIV as the band for the current step.

Key Path	Source, List Sequencer, List Sequencer Setup, Radio Setup, Radio Standard, WCDMA
Initial S/W Revision	A.05.00

LTE

Pressing this key once selects LTE FDD as the radio standard and the current LTE FDD band as the active channel band. Pressing this key again allows access to the sub-menus for selecting a different LTE FDD band.

Key Path	Source, List Sequencer, List Sequencer Setup, Radio Setup, Radio Standard
Initial S/W Revision	A.09.50

BAND 1

Selects BAND 1 as the band for the current step.

Key Path	Source, List Sequencer, List Sequencer Setup, Radio Setup, Radio Standard, LTE
Initial S/W Revision	A.09.50

BAND 2

Selects BAND 2 as the band for the current step.

Key Path	Source, List Sequencer, List Sequencer Setup, Radio Setup, Radio Standard, LTE
Initial S/W Revision	A.09.50

BAND 3

Selects BAND 3 as the band for the current step.

Key Path	Source, List Sequencer, List Sequencer Setup, Radio Setup, Radio Standard, LTE
Initial S/W Revision	A.09.50

BAND 4

Selects BAND 4 as the band for the current step.

Key Path	Source, List Sequencer, List Sequencer Setup, Radio Setup, Radio Standard, LTE
Initial S/W Revision	A.09.50

BAND 5

Selects BAND 5 as the band for the current step.

Key Path	Source, List Sequencer, List Sequencer Setup, Radio Setup, Radio Standard, LTE
Initial S/W Revision	A.09.50

BAND 6

Selects BAND 6 as the band for the current step.

Key Path	Source, List Sequencer, List Sequencer Setup, Radio Setup, Radio Standard, LTE
Initial S/W Revision	A.09.50

BAND 7

Selects BAND 7 as the band for the current step.

Key Path	Source, List Sequencer, List Sequencer Setup, Radio Setup, Radio Standard, LTE
Initial S/W Revision	A.09.50

BAND 8

Selects BAND 8 as the band for the current step.

Key Path	Source, List Sequencer, List Sequencer Setup, Radio Setup, Radio Standard, LTE
Initial S/W Revision	A.09.50

BAND 9

Selects BAND 9 as the band for the current step.

Key Path	Source, List Sequencer, List Sequencer Setup, Radio Setup, Radio Standard, LTE
Initial S/W Revision	A.09.50

BAND 10

Selects BAND 10 as the band for the current step.

Key Path	Source, List Sequencer, List Sequencer Setup, Radio Setup, Radio Standard, LTE
Initial S/W Revision	A.09.50

BAND 11

Selects BAND 11 as the band for the current step.

Key Path	Source, List Sequencer, List Sequencer Setup, Radio Setup, Radio Standard, LTE
Initial S/W Revision	A.09.50

BAND 12

Selects BAND 12 as the band for the current step.

Key Path	Source, List Sequencer, List Sequencer Setup, Radio Setup, Radio Standard, LTE
Initial S/W Revision	A.09.50

BAND 13

Selects BAND 13 as the band for the current step.

Key Path	Source, List Sequencer, List Sequencer Setup, Radio Setup, Radio Standard, LTE
Initial S/W Revision	A.09.50

BAND 14

Selects BAND 14 as the band for the current step.

Key Path	Source, List Sequencer, List Sequencer Setup, Radio Setup, Radio Standard, LTE
Initial S/W Revision	A.09.50

BAND 17

Selects BAND 17 as the band for the current step.

Key Path	Source, List Sequencer, List Sequencer Setup, Radio Setup, Radio Standard, LTE
Initial S/W Revision	A.09.50

BAND 18

Selects BAND 18 as the band for the current step.

Key Path	Source, List Sequencer, List Sequencer Setup, Radio Setup, Radio Standard, LTE
Initial S/W Revision	A.09.50

BAND 19

Selects BAND 19 as the band for the current step.

Key Path	Source, List Sequencer, List Sequencer Setup, Radio Setup, Radio Standard, LTE
Initial S/W Revision	A.09.50

BAND 20

Selects BAND 20 as the band for the current step.

Key Path	Source, List Sequencer, List Sequencer Setup, Radio Setup, Radio Standard, LTE
Initial S/W Revision	A.09.50

BAND 21

Selects BAND 21 as the band for the current step.

Key Path	Source, List Sequencer, List Sequencer Setup, Radio Setup, Radio Standard, LTE
Initial S/W Revision	A.09.50

BAND 24

Selects BAND 24 as the band for the current step.

Key Path	Source, List Sequencer, List Sequencer Setup, Radio Setup, Radio Standard, LTE
Initial S/W Revision	A.09.50

BAND 25

Selects BAND 25 as the band for the current step.

Key Path	Source, List Sequencer, List Sequencer Setup, Radio Setup, Radio Standard, LTE
Initial S/W Revision	A.09.50

BAND 26

Selects BAND 26 as the band for the current step.

Key Path	Source, List Sequencer, List Sequencer Setup, Radio Setup, Radio Standard, LTE
Initial S/W Revision	A.12.53

BAND 27

Selects BAND 27 as the band for the current step.

Key Path	Source, List Sequencer, List Sequencer Setup, Radio Setup, Radio Standard, LTE
Initial S/W Revision	A.14.00

BAND 28

Selects BAND 28 as the band for the current step.

Key Path	Source, List Sequencer, List Sequencer Setup, Radio Setup, Radio Standard, LTE
Initial S/W Revision	A.14.00

BAND 31

Selects BAND 31 as the band for the current step.

Key Path	Source, List Sequencer, List Sequencer Setup, Radio Setup, Radio Standard, LTE
Initial S/W Revision	A.14.00

LTE TDD

Sets LTE TDD as the radio standard for use and accesses the LTE TDD specific channel band sub-menus..

Key Path	Source, Frequency, Radio Setup, Radio Standard
Initial S/W Revision	A.11.50

BAND 33

Selects BAND 33 as the band for the current step.

Key Path	Source, Frequency, Radio Setup, Radio Standard, LTE TDD
Example	:SOUR:FREQ:CHAN:BAND BAND33
Initial S/W Revision	A.11.50

BAND 34

Selects BAND 34 as the band for the current step.

Key Path	Source, Frequency, Radio Setup, Radio Standard, LTE TDD
Example	:SOUR:FREQ:CHAN:BAND BAND34
Initial S/W Revision	A.11.50

BAND 35

Selects BAND 35 as the band for the current step.

Key Path	Source, Frequency, Radio Setup, Radio Standard, LTE TDD
Example	:SOUR:FREQ:CHAN:BAND BAND35
Initial S/W Revision	A.11.50

BAND 36

Selects BAND 36 as the band for the current step.

Key Path	Source, Frequency, Radio Setup, Radio Standard, LTE TDD
Example	:SOUR:FREQ:CHAN:BAND BAND36
Initial S/W Revision	A.11.50

BAND 37

Selects BAND 37 as the band for the current step.

Key Path	Source, Frequency, Radio Setup, Radio Standard, LTE TDD
Example	:SOUR:FREQ:CHAN:BAND BAND37
Initial S/W Revision	A.11.50

BAND 38

Selects BAND 38 as the band for the current step.

Key Path	Source, Frequency, Radio Setup, Radio Standard, LTE TDD
Example	:SOUR:FREQ:CHAN:BAND BAND38
Initial S/W Revision	A.11.50

BAND 39

Selects BAND 39 as the band for the current step.

Key Path	Source, Frequency, Radio Setup, Radio Standard, LTE TDD
Example	:SOUR:FREQ:CHAN:BAND BAND39
Initial S/W Revision	A.11.50

BAND 40

Selects BAND 40 as the band for the current step.

Key Path	Source, Frequency, Radio Setup, Radio Standard, LTE TDD
Example	:SOUR:FREQ:CHAN:BAND BAND40
Initial S/W Revision	A.11.50

BAND 41

Selects BAND 41 as the band for the current step.

Key Path	Source, Frequency, Radio Setup, Radio Standard, LTE TDD
Example	:SOUR:FREQ:CHAN:BAND BAND41
Initial S/W Revision	A.11.50

BAND 42

Selects BAND 42 as the band for the current step.

Key Path	Source, Frequency, Radio Setup, Radio Standard, LTE TDD
Example	:SOUR:FREQ:CHAN:BAND BAND42
Initial S/W Revision	A.11.50

BAND 43

Selects BAND 43 as the band for the current step.

Key Path	Source, Frequency, Radio Setup, Radio Standard, LTE TDD
Example	:SOUR:FREQ:CHAN:BAND BAND43
Initial S/W Revision	A.11.50

BAND 44

Selects BAND 44 as the band for the current step.

Key Path	Source, List Sequencer, List Sequencer Setup, Radio Setup, Radio Standard, LTE TDD
Initial S/W Revision	A.14.00

TDSCDMA

Sets TDSCDMA as the radio standard for use and accesses the TDSCDMA specific channel band sub-menus..

Key Path	Source, Frequency, Radio Setup, Radio Standard
Initial S/W Revision	A.11.50

BAND A

Selects BAND A as the band for the current step.

Key Path	Source, Frequency, Radio Setup, Radio Standard, TDSCDMA
Example	:SOUR:FREQ:CHAN:BAND BANDA
Initial S/W Revision	A.11.50

BAND B

Selects BAND B as the band for the current step.

Key Path	Source, Frequency, Radio Setup, Radio Standard, TDSCDMA
Example	:SOUR:FREQ:CHAN:BAND BANDB
Initial S/W Revision	A.11.50

BAND C

Selects BAND C as the band for the current step.

Key Path	Source, Frequency, Radio Setup, Radio Standard, TDSCDMA
Example	:SOUR:FREQ:CHAN:BAND BANDC
Initial S/W Revision	A.11.50

BAND D

Selects BAND D as the band for the current step.

Key Path	Source, Frequency, Radio Setup, Radio Standard, TDSCDMA
Example	:SOUR:FREQ:CHAN:BAND BANDD
Initial S/W Revision	A.11.50

BAND E

Selects BAND E as the band for the current step.

Key Path	Source, Frequency, Radio Setup, Radio Standard, TDSCDMA
Example	:SOUR:FREQ:CHAN:BAND BANDE
Initial S/W Revision	A.11.50

BAND F

Selects BAND F as the band for the current step.

Key Path	Source, Frequency, Radio Setup, Radio Standard, TDSCDMA
Example	:SOUR:FREQ:CHAN:BAND BANDF
Initial S/W Revision	A.11.50

Radio Band Link

Allows you to specify the radio band link direction for the steps within the list sequence. The link is used in conjunction with the channel band and channel number to determine the output frequency.

When set to “Uplink”, the source will calculate the uplink frequency according to an uplink formula together with selected channel band and channel number. When set to “Downlink”, the source will calculate the downlink frequency according to a downlink formula together with selected channel band and channel number.

Key Path	Source, List Sequencer, List Sequencer Setup, Radio Setup
Remote Command	:SOURce:LIST:STEP[1] 2 3...1000:SETup:RADio:BAND:LINK DOWN UP :SOURce:LIST:STEP[1] 2 3...1000:SETup:RADio:BAND:LINK?
Example	:SOUR:LIST:STEP2:SET:RAD:BAND:LINK UP :SOUR:LIST:STEP2:SET:RAD:BAND:LINK?
Notes	SCPI is supported after A.09.40
Preset	DOWN
Range	DOWN UP
Initial S/W Revision	A.05.00

Channel

Allows you to specify the frequency of the current step via a channel number.

Key Path	Source, List Sequencer, List Sequencer Setup
Remote Command	:SOURce:LIST:STEP[1] 2 3...1000:SETup:CNFRrequency <double> :SOURce:LIST:STEP[1] 2 3...1000:SETup:CNFRrequency?
Example	:SOUR:LIST:STEP2:SET:CNFR 124 :SOUR:LIST:STEP2:SET:CNFR?
Notes	SCPI is supported after A.09.40. This SCPI is used to setup channel number or frequency setting, according to current Radio Band setting. If Radio Band is "NONE", then it's frequency. If Radio Band is not "NONE", then it's channel number.
Couplings	The channel number is coupled to the step frequency value. When the step frequency value is changed, the channel number will increase or decrease to match the new step frequency. If the step frequency is not at an exact match for a channel number, the nearest channel number is displayed, along with a greater than, or less than sign to indicate the frequency is above or below the channel number.
Preset	1
Min	0 (Please refer to for valid ranges.)
Max	10838 (Please refer to for valid ranges.)
Initial S/W Revision	A.05.00

Frequency

Allows you to specify a frequency value for the current step.

Key Path	Source, List Sequencer, List Sequencer Setup
Remote Command	:SOURce:LIST:STEP[1] 2 3...1000:SETup:CNFRrequency <double> :SOURce:LIST:STEP[1] 2 3...1000:SETup:CNFRrequency?
Example	:SOUR:LIST:STEP2:SET:CNFR 1GHz :SOUR:LIST:STEP2:SET:CNFR?
Notes	SCPI is supported after A.09.40. This SCPI is used to setup channel number or frequency setting, according to current Radio Band setting. If Radio Band is "NONE", then it's frequency. If Radio Band is not "NONE", then it's channel number.
Couplings	The frequency value is coupled to the channel band and number for the step, such that updates to the radio band and channel number will update the frequency value to the corresponding absolute frequency. The reverse is also true, changing the frequency value causes the value of the channel number to be updated.
Preset	1.00 GHz
Min	10.00 MHz
Max	Hardware Dependant:

	Option 503 = 3.6 GHz Option 504 = 3.9 GHz Option 506 = 6.00 GHz
Initial S/W Revision	A.05.00

Power

Allows you to specify a power value for the current step.

Key Path	Source, List Sequencer, List Sequencer Setup
Remote Command	:SOURce:LIST:STEP[1] 2 3...1000:SETup:AMPLitude <double> :SOURce:LIST:STEP[1] 2 3...1000:SETup:AMPLitude?
Example	:SOUR:LIST:STEP2:SET:AMPL -50dBm :SOUR:LIST:STEP2:SET:AMPL?
Notes	SCPI is supported after A.09.40
Notes	Amplitude corrections can be specified for use with the source. In the event of amplitude corrections being applied, the valid ranges for the RF power do not change dependant on the current amplitude correction setting. Instead, if the combination of RF power + amplitude correction is higher or lower than the source output range, the Source Unleveled bit is set and the "Source Unleveled" indicator will appear on status panel to indicate that the source cannot maintain the output power that has been requested. The multiport adapter RFIO TX ports and GPS ports cannot ensure power accuracy when power setting is lower than -130dBm, this power setting value is defined by the sum of RF Power setting and related amplitude correction value. But user settable value could be lower than this limit. When application detected there exists power setting lower than -130dBm on MPA RFIO TX ports, then popup warning message . When application detected there exists power setting lower than -130dBm on MPA GPS ports, then popup warning message . These are only warning messages, and check is performed when RF is ON.
Notes	The Min and Max value here defined UI settable amplitude range. This range is larger than actual amplitude range with level accuracy defined in spec.
Dependencies	The RF power is dependent on the RF output port and frequency, such that the current frequency and selected output port determine the valid range of power values.
Preset	-100 dBm
Min	The range of values depends on the current frequency and selected RF output port. Please refer to "RF Power" on page 2098 and the table RF Power Range for the valid ranges.
Max	The range of values depends on the current frequency and selected RF output port. Please refer to "RF Power" on page 2098 and the table RF Power Range for the valid ranges.
Initial S/W Revision	A.05.00

Waveform

Allows you access to the sub-menus for selecting the waveform to be played back during the current step. Pressing this key also changes the central display area to show the Waveform File Selection view.

Key Path	Source, List Sequencer, List Sequencer Setup
Remote Command	:SOURce:LIST:STEP[1] 2 3...1000:SETup:WAVeform <string> :SOURce:LIST:STEP[1] 2 3...1000:SETup:WAVeform?
Example	:SOUR:LIST:STEP2:SET:WAV "CW" :SOUR:LIST:STEP2:SET:WAV?
Notes	SCPI is supported after A.09.40
Remote Command Notes	String type, takes "Off" "CW" "Cont" "waveform name"
Preset	CW
Range	Waveform Continue Previous CW Off
Initial S/W Revision	A.05.00

CW

Sets the current step to output a CW tone.

Key Path	Source, List Sequencer, List Sequencer Setup, Waveform
Example	:SOUR:LIST:STEP2:SET:WAV "CW"
Notes	SCPI is supported after A.09.40
Initial S/W Revision	A.05.00

Selected Waveform

Inserts the currently selected waveform in the waveform selection view as the waveform for playback during the current step.

Key Path	Source, List Sequencer, List Sequencer Setup, Waveform
Example	:SOUR:LIST:STEP2:SET:WAV "waveform name"
Notes	SCPI is supported after A.09.40 If the selected waveform contains header (which contains ARB play parameters), source list sequence will automatically apply header settings of the selected waveform in that step.
Initial S/W Revision	A.05.00

Continue Previous

Sets the current step to continue with playback of the waveform from the previous step. When continuing the previous waveform, the ARB playback will not pause while the source retunes to the new frequency or amplitude that may be defined for the new step.

Key Path	Source, List Sequencer, List Sequencer Setup, Waveform
----------	--

Example	:SOUR:LIST:STEP2:SET:WAV "Cont"
Notes	SCPI is supported after A.09.40
Initial S/W Revision	A.05.00

Off

Disable RF output of the current step.

Key Path	Source, List Sequencer, List Sequencer Setup, Waveform
Example	:SOUR:LIST:STEP2:SET:WAV "Off"
Notes	SCPI is supported after A.09.40
Initial S/W Revision	A.05.00

Segments on Hard Disk

Allows you access to the sub-menus for loading waveform segments from the hard disk into ARB memory. The default directory is: D: varb.

Pressing this key changes the current view to the Waveform Management View.

Key Path	Source, Modulation Setup, ARB, Select Waveform
Initial S/W Revision	A.05.00

Load Segment To ARB Memory

Allows you to load the selected file into ARB memory. On the front panel you select the file for loading to the ARB memory by highlighting the desired file in the list. Using the SCPI command, you specify the file name on the HDD.

"NVWFM" (none-volatile storage) MSUS (Mass Storage Unit Specifier) is supported in the memory subsystem because the ARB memory cannot be accessed directly. Therefore, files must be downloaded to the instrument hard disk and then loaded into the ARB memory. "NVWFM" MSUS will be mapped to the default directory D: VARB. The SCPI command supports using either "NVWFM" MSUS or specifying a full path. For more information, see Memory Subsystem (Remote Command Only).

If a file of the same name already exists within ARB memory, it is overwritten. If you wish to load two segments of the same name, you must rename one of the segments before loading it into ARB memory. To rename a segment, you can either use Windows File Explorer, or the :MMEMory:COPY command.

NOTE: When a waveform file is loaded to ARB memory, burst timing adjustments are made automatically, based on whether or not a Multiport Adapter is connected to the test set and powered on. If the connection/power status of the Multiport Adapter is changed after a waveform file has been loaded, it needs to be loaded again.

Key Path	Source, Modulation Setup, ARB, Select Waveform, Segments on Hard Disk
Remote Command	:SOURce:RADio:ARB:LOAD <string>
Example	:SOUR:RAD:ARB:LOAD "D: VARB\testwaveform.bin" or :SOUR:RAD:ARB:LOAD "NVWFM:testwaveform.bin"
Notes	<p>Because loading the file involves a delay of unpredictable length, this command should be followed by the query *OPC?, which holds off subsequent commands until the loading operating is complete.</p> <p><string> – specifies the path name of the file to load from the HDD into ARB memory. It could be a <full path + filename>, or <"NVWFM" MSUS + colon + filename>.</p> <p>When in Sequence Analyzer mode, and Include Source is Yes, an attempt to load a file to ARB memory will be rejected with an error.</p> <p>When Include Source is No and if there is insufficient free ARB memory to load the selected waveform, an error is generated. .</p> <p>If you specify a file over SCPI, but the file is not at the specified location, an error is generated.</p> <p>If you try to load a waveform file but the file contains less than 500 IQ samples, an error is generated.</p> <p>If you try to load a Signal Studio waveform "*.wfm" which contains invalid waveform header, an error is generated.</p> <p>If the ARB is ON when you load a file to ARB memory or delete a file from ARB memory, the playing waveform segment may not keep phase continuity during the ARB memory operation. The waveform will be replayed after the ARB operation is finished.</p> <p>ARB can be loaded into ARB memory even required licenses do not present on the instrument. In this case, a GUI only warning message -800, "Operation complete; Loaded <filename> successfully, but no license <required licenses> installed". User can install required licenses according to <required licenses> string to license it, or multi-pack license it.</p>
Initial S/W Revision	A.05.00

Load All To ARB Memory

Allows you to load all the segment files within the currently selected directory into ARB memory. If a file of the same name already exists within ARB memory, it is overwritten. If you wish to load two segments of the same name, you must rename one of the segments before loading it into ARB memory. To rename a segment, you can either use Windows File Explorer, or the :MEMory:COpy command.

NOTE: When a waveform file is loaded to ARB memory, burst timing adjustments are made automatically, based on whether or not a Multiport Adapter is connected to the test set and powered on. If the connection/power status of the Multiport Adapter is changed after a waveform file has been loaded, it needs to be loaded again.

Key Path	Source, Modulation Setup, ARB, Select Waveform, Segments on Hard Disk
Remote Command	:SOURce:RADio:ARB:LOAD:ALL <string>
Example	:SOUR:RAD:ARB:LOAD:ALL "D: varb"
Notes	<p><string> - specifies the directory on the HDD to load the files into ARB memory from.</p> <p>When in Sequence Analyzer mode, and Include Source is Yes, an attempt to load all files from a directory to ARB memory is rejected with an error.</p>

When Include Source is No and there is insufficient free ARB memory to load all the waveforms, when the ARB memory is full, the copy ceases, and an error is generated.

If you specify a directory over SCPI, but the directory does not exist, an error is generated.

If the ARB is ON, a user then loads or deletes file to ARB memory, the playing waveform segment may not keep phase continuity during the ARB memory operation. The waveform will be replayed after the ARB operation is finished.

Initial S/W Revision	A.05.00
----------------------	---------

Change Directory...

Allows you to change the currently selected directory on the hard disk. Pressing this key opens a standard windows change directory dialog allowing you to select the new directory of interest.

The current directory is used for manually loading waveform segments into ARB memory for playback, and as a search location for waveform segments that are required to be loaded into ARB memory for playback of a waveform sequence or a list sequence.

Key Path	Source, Modulation Setup, ARB, Select Waveform, Segments on Hard Disk
Notes	No remote command, SCPI front panel only.
Initial S/W Revision	A.05.00

Default Directory...

Allows you to change the default directory. It is used as a search location for waveform segments that are required to be loaded into ARB memory for playback of a waveform sequence, and as a search location for selecting waveforms using SCPI.

Key Path	Source, Modulation Setup, ARB, Select Waveform, Segments on Hard Disk
Remote Command	:SOURce:RADio:ARB:DEFault:DIRectory <string> :SOURce:RADio:ARB: DEFault:DIRectory?
Example	:SOUR:RAD:ARB:DEF:DIR "D:\ArbFiles" :SOUR:RAD:ARB:DEF:DIR?
State Saved	Persistent, survives a power cycle and a preset but not saved in the instrument state
Initial S/W Revision	A.05.00

Segments in ARB Memory

Allows you access to the sub-menus for managing the files within ARB memory.

Key Path	Source, Modulation Setup, ARB, Select Waveform
Initial S/W Revision	A.05.00

Delete Segment From ARB Mem

Allows you to remove a segment from ARB playback memory.

Key Path	Source, Modulation Setup, ARB, Select Waveform, Segments in ARB Memory
Remote Command	:SOURce:RADio:ARB:DELeTe <string>
Example	:SOUR:RAD:ARB:DEL "testwaveform.bin"
Notes	<p><string> - specifies the waveform to be deleted from the ARB playback memory.</p> <p>When in Sequence Analyzer mode and Include Source is Yes, an attempt to delete a file from ARB memory is rejected with an error.</p> <p>When Include Source is No and you specify a file that does not exist within ARB memory, an error is generated.</p> <p>It is possible to delete files from within the ARB memory when the ARB is ON. However, if you attempt to delete the file that is currently playing an error is generated.</p> <p>It is possible to delete a file from within the ARB memory when the sequencer state is ON and the file is not being used by the List Sequencer. If you attempt to delete a file which is being used by the list sequencer, an error is generated.</p> <p>When sequencer state is On, even if ARB state is On, the selected waveform will not be played. In this case, if the selected waveform is not used in List Sequence, it can be deleted and the ARB state is turned Off.</p> <p>If the ARB is ON and you load a file to ARB memory or delete a file from ARB memory, the playing waveform segment may not keep phase continuity during the ARB memory operation. The waveform will be replayed after the ARB operation is finished.</p>
Initial S/W Revision	A.05.00

Delete All From ARB Memory

Allows you to remove all segments from ARB playback memory.

Key Path	Source, Modulation Setup, ARB, Select Waveform, Segments in ARB Memory
Remote Command	:SOURce:RADio:ARB:DELeTe:ALL
Example	:SOUR:RAD:ARB:DELeTe:ALL
Notes	<p>When in Sequence Analyzer mode and Include Source is Yes, an attempt to delete all files from ARB memory is rejected with an error.</p> <p>When Include Source is No and you attempt to delete all files from ARB memory when the ARB is currently playing a file, all files except the one playing are deleted and an error is generated.</p> <p>If you attempt to delete all files from ARB memory when there are waveform files used in "List Sequencer" on page 2168 and "Sequencer" on page 2168 state is ON, all files except the files currently being used in list sequencer are deleted, and an error is generated.</p> <p>If the ARB is ON and you load a file to ARB memory or delete a file from ARB memory, the playing waveform segment may not keep phase continuity during the ARB memory operation. The waveform will be replayed after the ARB operation is finished.</p>
Initial S/W Revision	A.05.00

Step Duration

Allows access to the sub-menus for setting up the duration of play for the current step.

The duration can be set to be either the number of times for the ARB file associated with the sequence to play, or a specific time value, or continuous. If the step is set to play a CW tone, the step duration cannot be set to a play count.

Key Path	Source, List Sequencer, List Sequencer Setup
Remote Command	:SOURce:LIST:STEP[1] 2 3...1000:SETup:DURation:TYPE TIME COUNT CONTInuous CABort :SOURce:LIST:STEP[1] 2 3...1000:SETup:DURation:TYPE?
Example	:SOUR:LIST:STEP2:SET:DUR:TYPE TIME :SOUR:LIST:STEP2:SET:DUR:TYPE?
Notes	SCPI is supported after A.09.40
Notes	If “Step Duration” is set to “Time” or “Play Count” for the last step, the last step of ARB keeps playing as if set to “Continuous”, until the set “Time” has expired or until the “Play Count” setting is reached. However, you can query Error! Reference source not found. Source Sweeping Condition Message to find out if the current list sequence is complete or not.
Range	Time Play Count Continuous Continuous Abort
Initial S/W Revision	A.05.00

Time

Sets the duration of the current step to be a time value for the length of time the step will play. Pressing this key again opens another menu which allows you to set the time value for the step duration.

Key Path	Source, List Sequencer, List Sequencer Setup, Step Duration
Example	:SOUR:LIST:STEP2:SET:DUR:TYPE TIME
Notes	SCPI is supported after A.09.40
Initial S/W Revision	A.05.00

Duration Time

Allows you to specify the length of time the current step will play.

If the Transition Time value is longer than the Step Duration Time, an error is generated when initiating a source list sequence. For source list sequence, transition time is included in the step duration length (not occupy additional time). If the Transition Time value is longer than the Step Duration Time, the real step duration length is extended to equal the transition time and cause a timing shift. This check is also described in section **Error! Reference source not found.** List Sequence Step Validation.

Key Path	Source, List Sequencer, List Sequencer Setup, Step Duration, Time
Remote Command	:SOURce:LIST:STEP[1] 2 3...1000:SETup:DURation:TCOUNT <double> :SOURce:LIST:STEP[1] 2 3...1000:SETup:DURation:TCOUNT?

Example	:SOUR:LIST:STEP2:SET:DUR:TCO 1s :SOUR:LIST:STEP2:SET:DUR:TCO?
Notes	SCPI is supported after A.09.40 This SCPI is reused by "Play Count", "Duration Time" and "Continuous Abort" according to current Duration Type setting is "Play Count" or "Duration Time" or "Continuous Abort". If current "Duration Type" is "Continuous", then popup error -221, "Settings conflict; Cannot accept time or count input when step duration type is Continuous on step #"
Notes	If "Duration Time" is set for the last step, the last step of ARB keeps playing as if set to "Continuous" after set time expires. However, you can query Source Sweeping Condition Message (:STAT:OPER:COND?) to find out if the current list sequence is complete or not.
Preset	1.00 ms
Min	100 µs
Max	1800 s
Initial S/W Revision	A.05.00

Play Count

Sets the duration of the current step to be an integer value for the number of times (play count) the ARB file is selected for playback during this step. For example, a 5 second ARB will be set to play 5 times during the step.

Key Path	Source, List Sequencer, List Sequencer Setup, Step Duration
Example	:SOUR:LIST:STEP2:SET:DUR:TYPE COUN
Notes	SCPI is supported after A.09.40 This key is unavailable and is grayed out if the current step is configured to CW tone rather than an ARB waveform.
Initial S/W Revision	A.05.00

Header Utilities

Allows access to the header utilities sub-menu. Pressing this key also causes the central display area to change to display the File Header Information view.

Key Path	Source, Modulation Setup, ARB
Dependencies	This key is only available if there is currently a waveform selected for playback. If no waveform is selected, the key is grayed out.
Initial S/W Revision	A.05.00

Continuous

Sets the current step to be played continuously until the next step starts. The waveform will always play completely before transitioning to the next step.

Key Path	Source, List Sequencer, List Sequencer Setup, Step Duration
Example	:SOUR:LIST:STEP2:SET:DUR:TYPE CONT
Notes	SCPI is supported after A.09.40
Initial S/W Revision	A.05.00

Output Trigger

Allows you to specify the trigger output for the current step. The trigger output signal is sent at the start of the step.

When select “On”, trigger event will occur on both Internal and External2 paths. Select “Off” will turn off trigger output.

Key Path	Source, List Sequencer, List Sequencer Setup
Remote Command	:SOURce:LIST:STEP[1] 2 3...1000:SETup:OUTPut:TRIGger ON OFF 1 0 :SOURce:LIST:STEP[1] 2 3...1000:SETup:OUTPut:TRIGger
Example	:SOUR:LIST:STEP2:SET:OUTP:TRIG ON :SOUR:LIST:STEP2:SET:OUTP:TRIG?
Notes	SCPI is supported after A.09.40
Preset	Off
Range	On Off
Initial S/W Revision	A.05.00

Repetition

Allows access to the sub-menu for selecting the repetition type for the list sequencer globally. It cannot be changed between different sequence steps.

Key Path	Source, List Sequencer
Remote Command	:SOURce:LIST:REPetition:TYPE SINGLE CONTInuous
Example	:SOUR:LIST:REP:TYPE SING :SOUR:LIST:REP:TYPE?
Preset	SINGle
Range	SINGle CONTInuous
Initial S/W Revision	A.14.50

Single

Sets the repetition type as single for the whole source sequence. Source list will play one time after initiation.

Key Path	Source, List Sequencer, Repetition
Example	:SOUR:LIST:REP:TYPE SINGLE
Initial S/W Revision	A.14.50

Continuous

Sets the repetition type as continuous for the whole source sequence. Source list will play continuously after initiation.

Key Path	Source, List Sequencer, Repetition
Example	:SOUR:LIST:REP:TYPE CONTInuous
Initial S/W Revision	A.14.50

Trigger Type

Allows access to the sub-menu for selecting the output trigger type for the list sequencer globally. It cannot be changed between different sequence steps.

Key Path	Source, List Sequencer
Remote Command	:SOURce:LIST:TRIGgerout:TYPe BEGInningofstep DATamarker
Example	:SOUR:LIST:TRIG:TYP BEG :SOUR:LIST:TRIG:TYP?
Notes	SCPI is supported after A.14.00
Preset	BEGInningofstep
Range	BEGInningofstep DATamarker
Initial S/W Revision	A.14.00

BeginningOfStep

Sets the output trigger type as BeginningOfStep for the whole source sequence.

Key Path	Source, List Sequencer, Trigger Type
Example	:SOUR:LIST:TRIG:TYP BEG
Notes	SCPI is supported after A.14.00
Initial S/W Revision	A.14.00

DataMarker

Sets the output trigger type as DataMarker for the whole source sequence. When DataMarker is selected, which marker to route is also needed to be set.

Key Path	Source, List Sequencer, Trigger Type
Example	:SOUR:LIST:TRIG:TYP DAT
Notes	SCPI is supported after A.14.00
Initial S/W Revision	A.14.00

Marker 1

Sets the output trigger maker routing to Marker 1 for DataMarker in the whole source sequence.

Key Path	Source, List Sequencer, Trigger Type, DataMarker
Example	:SOUR:LIST:TRIG:TYPE:MARK M1
Notes	SCPI is supported after A.14.00
Initial S/W Revision	A.14.00

Marker 2

Sets the output trigger maker routing to Marker 2 for DataMarker in the whole source sequence.

Key Path	Source, List Sequencer, Trigger Type, DataMarker
Example	:SOUR:LIST:TRIG:TYPE:MARK M2
Notes	SCPI is supported after A.14.00
Initial S/W Revision	A.14.00

Marker 3

Sets the output trigger maker routing to Marker 3 for DataMarker in the whole source sequence.

Key Path	Source, List Sequencer, Trigger Type, DataMarker
Example	:SOUR:LIST:TRIG:TYPE:MARK M3
Notes	SCPI is supported after A.14.00
Initial S/W Revision	A.14.00

Marker 4

Sets the output trigger maker routing to Marker 4 for DataMarker in the whole source sequence.

Key Path	Source, List Sequencer, Trigger Type, DataMarker
Example	:SOUR:LIST:TRIG:TYPE:MARK M4
Notes	SCPI is supported after A.14.00
Initial S/W Revision	A.14.00

Manual Trigger Now

Pressing this key provides a software trigger event to the list sequencer. During execution of sequence, if the sequencer is halted on any step that has been configured with a “Manual” step trigger, then this key press will cause the sequencer to continue and execute the step.

Key Path	Source, List Sequencer
Remote Command	No remote command, front panel only.
Initial S/W Revision	A.05.00

Source Preset

Allows you to preset the source settings to their default values.

Key Path	Source
Remote Command	:SOURce:PRESet
Example	:SOUR:PRES

SPAN X Scale

Accesses a menu of functions that enable you set the horizontal scale parameters.

This menu is blank if the selected **window** is:

- I/Q Measured Polar Graph or,
- RMS EVM (Numeric Results).

For details of available **views** in this measurement, see "[View/Display](#)" on page 2211. Within a view, you can change the selected window by pressing the Next Window key.

Key Path	Front-panel key
Initial S/W Revision	Prior to A.02.00

Sweep/Control

Accesses a menu that enables you to pause and restart the measurement.

Key Path	Front-panel key
Initial S/W Revision	Prior to A.02.00

Pause

Pauses a measurement after the current data acquisition is complete. When Paused, the label on the key changes to Resume. Pressing the Resume key resumes the measurement from the point it was at when paused. See Pause/Resume for more details.

Key Path	Sweep/Control
Initial S/W Revision	Prior to A.02.00

System

See "System" on page 189

Trace/Detector

There is no Trace/Detector functionality supported in QPSK EVM. This front-panel key displays a blank menu when pressed.

Key Path	Front-panel key
Initial S/W Revision	Prior to A.02.00

Trigger

See ["Trigger" on page 248](#)

Free Run

See ["Free Run " on page 255](#)

Video

See ["Video \(IF Envelope\) " on page 1440](#)

Trigger Level

See ["Trigger Level " on page 1440](#)

Trig Slope

See ["Trig Slope " on page 1441](#)

Trig Delay

See ["Trig Delay " on page 258](#)

External 1

See ["External 1 " on page 1454](#)

Trigger Level

See ["Trigger Level " on page 1455](#)

Trig Slope

See ["Trig Slope " on page 1455](#)

Trig Delay

See ["Trig Delay " on page 261](#)

Zero Span Delay Comp

See ["Zero Span Delay Comp On/Off " on page 1443](#)

External 2

See ["External 2 " on page 1456](#)

Trigger Level

See ["Trigger Level " on page 1457](#)

Trig Slope

See ["Trig Slope " on page 1457](#)

Trig Delay

See "[Trig Delay](#) " on page 264

Zero Span Delay Comp

See "[Zero Span Delay Comp On/Off](#)" on page 1446

RF Burst

See "[RF Burst](#) " on page 1458

Absolute Trigger

See "[Absolute Trigger Level](#)" on page 1458

Relative Trigger

See "[Relative Trigger Level](#)" on page 1448

Trig Slope

See "[Trigger Slope](#) " on page 1459

Trig Delay

See "[Trig Delay](#) " on page 268

Periodic Timer

See "[Periodic Timer \(Frame Trigger\)](#) " on page 1449

Period

See "[Period](#) " on page 1451

Offset

See "[Offset](#) " on page 1451

Offset Adjust (Remote Command Only)

See "[Offset Adjust \(Remote Command Only\)](#)" on page 1452

Reset Offset Display

See "[Reset Offset Display](#) " on page 1453

Sync Source

See "[Sync Source](#) " on page 1453

Off

See "[Off](#) " on page 1454

External 1

See "External 1 " on page 1454

Trigger Level

See "Trigger Level " on page 1455

Trig Slope

See "Trig Slope " on page 1455

External 2

See "External 2 " on page 1456

Trigger Level

See "Trigger Level " on page 1457

Trig Slope

See "Trig Slope " on page 1457

RF Burst

See "RF Burst " on page 1458

Absolute Trigger

See "Absolute Trigger Level" on page 1458

Trig Slope

See "Trigger Slope " on page 1459

Trig Delay

See "Trig Delay" on page 280

Auto/Holdoff

See "Auto/Holdoff " on page 1460

Auto Trig

See "Auto Trig " on page 1461

Trig Holdoff

See "Trig Holdoff " on page 1461

Internal

See "Internal" on page 282

User Preset

Accesses a menu that gives you the following three choices:

- User Preset – recalls a state previously saved using the Save User Preset function.
- User Preset All Modes – presets all of the modes in the analyzer
- Save User Preset– saves the current state for the current mode

NOTE

In products that run multiple instances of the X-Series Application, all instances use the same location to save User Preset state. So Save User Preset of one instance will overwrite the Save User Preset of another instance.

Key Path	Front-panel key
Backwards Compatibility Notes	<p>User Preset is actually loading a state, and in legacy analyzers, it was possible to load a state without affecting the trace data, limit lines or correction data. Similarly it was possible to do a User Preset without affecting the trace data, limit lines or correction data.</p> <p>In the X-Series, “state” always includes all of this data; so whenever state is loaded, or User Preset is executed, all of the traces, limit lines and corrections are affected. Although this differs from previous behavior, it is desirable behavior, and should not cause adverse issues for users.</p> <p>On ESA and PSA, User Preset affected the entire instrument’s state. In the X-Series, User Preset only recalls the state for the active mode. There is a User Preset file for each mode. User Preset can never cause a mode switch as it can in legacy analyzers. If you want to recall all modes to their user preset file state, you will need to do a User Preset after mode switching into each mode.</p> <p>User Preset recalls mode state which can now include data like traces; whereas on ESA and PSA, User Preset did not affect data.</p>
Initial S/W Revision	Prior to A.02.00

User Preset

User Preset sets the state of the currently active mode back to the state that was previously saved for this mode using the Save User Preset menu key or the SCPI command, SYST:PRES:USER:SAV. It not only recalls the Mode Preset settings, but it also recalls all of the mode persistent settings, and the Input/Output system setting that existed at the time Save User Preset was executed.

If a Save User Preset has not been done at any time, User Preset recalls the default user preset file for the currently active mode. The default user preset files are created if, at power-on, a mode detects there is no user preset file. There will never be a scenario when there is no user preset file to restore. For each mode, the default user preset state is the same state that would be saved if a Save User Preset is performed in each mode right after doing a Restore Mode Default and after a Restore Input/Output Defaults.

The User Preset function does the following:

- Aborts the currently running measurement.
- Sets the mode State to the values defined by Save User Preset.
- Makes the saved measurement for the currently running mode the active measurement.
- Brings up the saved menu for the power-on mode.

- Clears the input and output buffers.
- Sets the Status Byte to 0.

Key Path	User Preset
Remote Command	:SYSTem:PRESet:USER
Example	:SYST:PRES:USER:SAVE:SYST:PRES:USER
Notes	:SYST:PRES:USER:SAVE is used to save the current state as the user preset state. Clears all pending OPC bits. The Status Byte is set to 0. Pressing the User Preset front-panel key while already in the User Preset menu will cause the User Preset to get executed
Couplings	A user preset will cause the currently running measurement to be aborted and cause the saved measurement to be active. Recalling a User Preset file has the same issues that recalling a Save State file has. Some settings may need to be limited and therefore re-coupled, since the capabilities of the mode may have changes when the User Preset file was last saved.
Initial S/W Revision	Prior to A.02.00

User Preset All Modes

Recalls all of the User Preset files for each mode, switches to the power-on mode, and activates the saved measurement from the power-on mode User Preset file.

NOTE

When the instrument is secured, all of the user preset files are converted back to their default user preset files.

The User Preset function does the following:

- Aborts the currently running measurement.
- Switches the Mode to the power-on mode.
- Restores the User Preset files for each mode.
- Makes the saved measurement for the power-on mode the active measurement.
- Brings up the saved menu for the power-on mode.
- Clears the input and output buffers.
- Sets the Status Byte to 0.

Key Path	User Preset
Remote Command	:SYSTem:PRESet:USER:ALL
Example	:SYST:PRES:USER:SAVE:SYST:PRES:USER:ALL
Notes	Clears all pending OPC bits. The Status Byte is set to 0. :SYST:PRES:USER:SAVE is used to save the current state as the user preset state.
Couplings	A user preset will cause the currently running measurement to be aborted, cause a mode switch to the power-on mode, and cause the saved measurement to be active in the power-on mode.

Recalling a User Preset file has the same issues that recalling a Save State file has. Some settings may need to be limited and therefore re-coupled, since the capabilities of the mode may have changes when the User Preset file was last saved.

Initial S/W Revision Prior to A.02.00

Save User Preset

Saves the currently active mode and its State. You can recall this User Preset file by pressing the User Preset menu key or sending the SYST:PRES:USER remote command. This same state is also saved by the Save State function.

Key Path	User Preset
Remote Command	:SYSTem:PRESet:USER:SAVE
Example	:SYST:PRES:USER:SAVE
Notes	:SYST:PRES:SAVE creates the same file as if the user requested a *SAV or a MMEM:STOR:STAT, except User Preset Save does not allow the user to specify the filename or the location of the file.
Initial S/W Revision	Prior to A.02.00

View/Display

Accesses a menu of functions that enable you to set up and control the display parameters for the current measurement.

Two views are available in this measurement, as described in the sections:

[I/Q Measured Polar Graph](#)

["I/Q Error View" on page 2222](#)

This topic contains the following sections:

["View Selection by name \(Remote Command Only\)" on page 2211](#)

["View Selection by number \(Remote Command only\)" on page 2211](#)

View Selection by name (Remote Command Only)

Selects the format for the measurement results view.

Mode	WCDMA, C2K, 1xEVDO
Remote Command	:DISPlay:EVMQpsk:VIEW[:SElect] POLar ERRor :DISPlay:EVMQpsk:VIEW[:SElect]?
Example	DISP:EVMQ:VIEW ERR DISP:EVMQ:VIEW?
Couplings	Changing parameter of "ViewNum" (:DISPlay:EVMQpsk:VIEW:NSElect) also changes this parameter.
Preset	POLar
State Saved	Saved in instrument state.
Range	I/Q Measured Polar Vector I/Q Error
Initial S/W Revision	Prior to A.02.00

View Selection by number (Remote Command only)

Displays the numeric values of the measurement results.

Mode	WCDMA, C2K, 1xEVDO
Remote Command	:DISPlay:EVMQpsk:VIEW:NSElect <integer> :DISPlay:EVMQpsk:VIEW:NSElect?
Example	DISP:EVMQ:VIEW:NSEL 2 DISP:EVMQ:VIEW:NSEL?
Couplings	Changing parameter of "View" (:DISPlay:EVMQpsk:VIEW[:SElect]) also changes this parameter.
Preset	1
State Saved	Saved in instrument state.
Min	1

Max	2
Initial S/W Revision	Prior to A.02.00

Key Path	Front-panel key
Initial S/W Revision	Prior to A.02.00

Display

The Display menu is common to most measurements, and is used for configuring items on the display. Some Display menu settings apply to all the measurements in a mode, and some only to the current measurement. Those under the System Display Settings key apply to all measurements in all modes.

Key Path	Display
Key Path	View/Display
Initial S/W Revision	Prior to A.02.00

Annotation

Turns on and off various parts of the display annotation. The annotation is divided up into four categories:

1. Meas Bar: This is the measurement bar at the top of the screen. It does not include the settings panel or the Active Function. Turning off the Meas Bar turns off the settings panel and the Active Function. When the Meas Bar is off, the graticule area expands to fill the area formerly occupied by the Meas Bar.
2. Screen Annotation: this is the annotation and annunciation around the graticule, including any annotation on lines (such as the display line, the threshold line, etc.) This does NOT include the marker number or the N dB result. When off, the graticule expands to fill the entire graticule area.
3. Trace annotation: these are the labels on the traces, showing their detector (or their math mode).
4. Active Function annotation: this is the active function display in the meas bar, and all of the active function values displayed on softkeys.

See the figure below. Each type of annotation can be turned on and off individually.

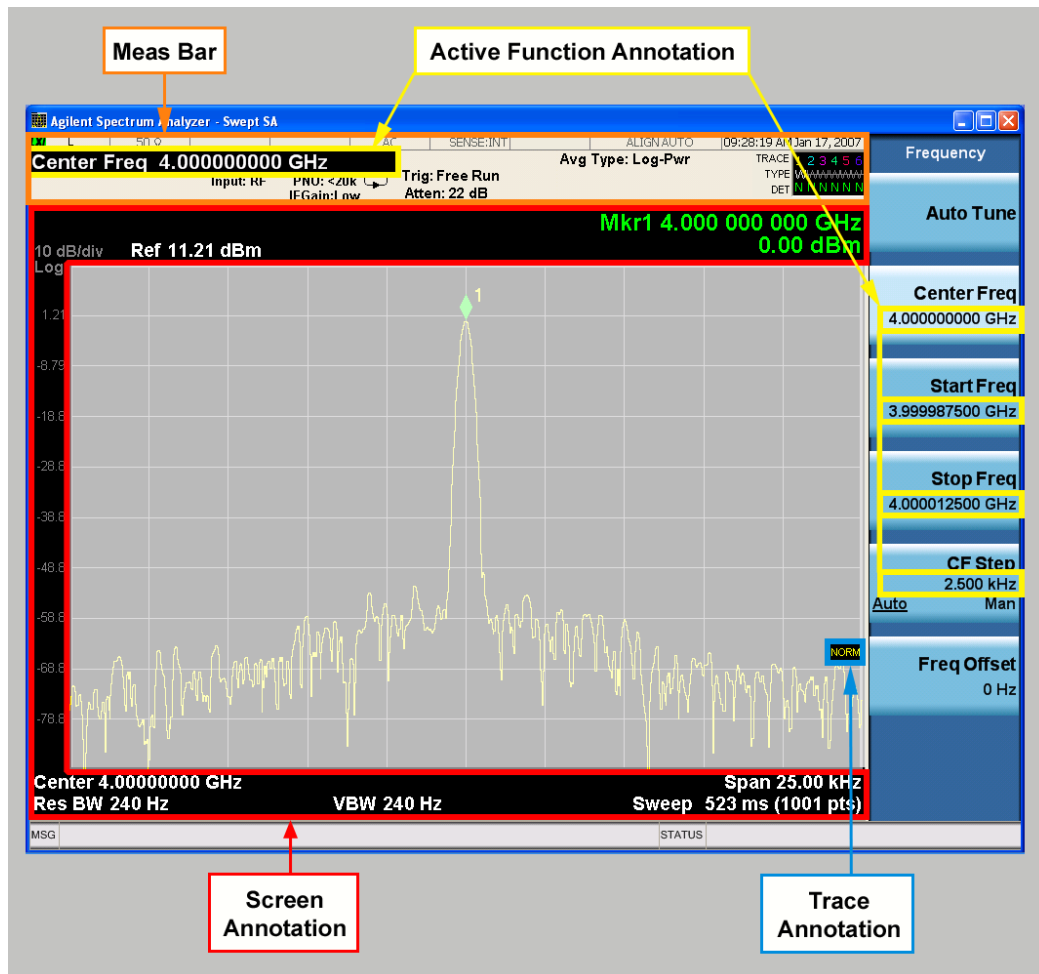

Key Path	View/Display, Display
Initial S/W Revision	Prior to A.02.00

Meas Bar On/Off

This function turns the Measurement Bar on and off, including the settings panel. When off, the graticule area expands to fill the area formerly occupied by the Measurement Bar.

Key Path	View/Display, Display, Annotation
Remote Command	:DISPlay:ANNotation:MBAR[:STATE] OFF ON 0 1 :DISPlay:ANNotation:MBAR[:STATE]?
Example	DISP:ANN:MBAR OFF
Dependencies	Grayed out and forced to OFF when System Display Settings, Annotation is set to Off.
Preset	On This should remain Off through a Preset when System DisplaySettings, Annotation is set to Off.

State Saved	Saved in instrument state.
Initial S/W Revision	Prior to A.02.00

Screen

This controls the display of the annunciation and annotation around the graticule, including any annotation on lines (such as the display line, the threshold line, etc.) and the y-axis annotation. This does NOT include marker annotation (or the N dB result). When off, the graticule expands to fill the entire graticule area, leaving only the 1.5% gap above the graticule as described in the Trace/Detector chapter.

Key Path	View/Display, Display, Annotation
Remote Command	:DISPlay:ANNotation:SCReen[:STATe] OFF ON 0 1 :DISPlay:ANNotation:SCReen[:STATe]?
Example	DISP:ANN:SCR OFF
Dependencies	Grayed-out and forced to OFF when System Display Settings, Annotation is set to Off.
Preset	On This should remain Off through a Preset when System DisplaySettings, Annotation is set to Off
State Saved	Saved in instrument state.
Initial S/W Revision	Prior to A.02.00

Active Function Values On/Off

Turns on and off the active function display in the Meas Bar, and all of the active function values displayed on the softkeys.

Note that all of the softkeys that have active functions have these numeric values blanked when this function is on. This is a security feature..

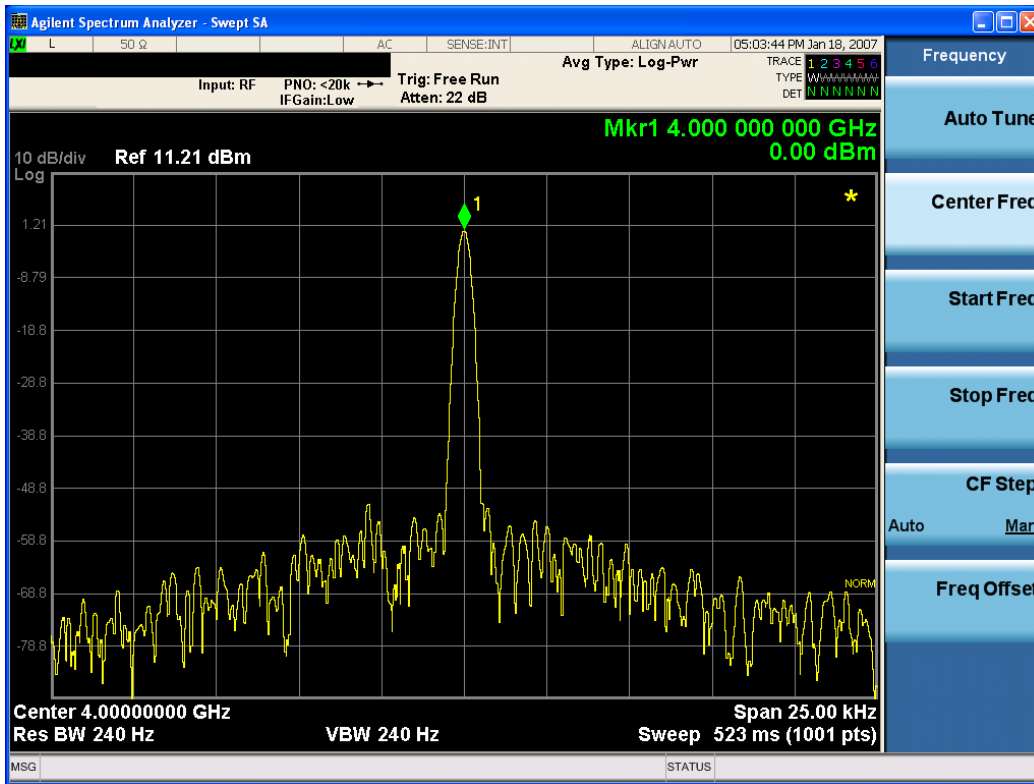

Key Path	View/Display, Display, Annotation
Remote Command	:DISPlay:ACTivefunc[:STATE] ON OFF 1 0 :DISPlay:ACTivefunc[:STATE]?
Example	DISP:ACT OFF
Dependencies	Grayed out and forced to OFF when System Display Settings, Annotation is set to Off.
Preset	On This should remain Off through a Preset when System DisplaySettings, Annotation is set to Off
State Saved	Saved in instrument state.
Initial S/W Revision	Prior to A.02.00

Title

Displays menu keys that enable you to change or clear a title on your display.

Key Path	View/Display, Display
Initial S/W Revision	Prior to A.02.00

Change Title

Writes a title into the "measurement name" field in the banner, for example, "Swept SA".

Press Change Title to enter a new title through the alpha editor. Press Enter or Return to complete the entry. Press ESC to cancel the entry and preserve your existing title.

The display title will replace the measurement name. It remains for this measurement until you press Change Title again, or you recall a state, or a Preset is performed. A title can also be cleared by pressing Title, Clear Title.

NOTE

Notice the inclusion of the <measurement> parameter in the command below. Because each measurement remembers the Display Title, the command must be qualified with the measurement name. For the Swept SA measurement this is not the case; no <measurement> parameter is used when changing the Display Title for the Swept SA measurement.

Key Path	View/Display, Display, Title
Mode	All
Remote Command	:DISPlay:<measurement>:ANNotation:TITLe:DATA <string> :DISPlay:<measurement>:ANNotation:TITLe:DATA?
Example	DISP:ANN:TITL:DATA "This Is My Title" This example is for the Swept SA measurement in the Spectrum Analyzer mode. The SANalyzer <measurement> name is not used. DISP:ACP:ANN:TITL:DATA "This Is My Title" This example is for Measurements other than Swept SA. Both set the title to: This Is My Title
Notes	Pressing this key cancels any active function. When a title is edited the previous title remains intact (it is not cleared) and the cursor goes at the end so that characters can be added or BKSP can be used to go back over previous characters.
Preset	No title (measurement name instead)
State Saved	Saved in instrument state.
Initial S/W Revision	Prior to A.02.00

Clear Title

Clears a title from the front-panel display. Once cleared, the title cannot be retrieved. After the title is cleared, the current Measurement Name replaces it in the title bar.

Key Path	View/Display, Display, Title
Example	The following commands clear the title and restore the measurement's original title: DISP:ANN:TITL:DATA "" This example is for the Swept SA measurement in the Spectrum Analyzer mode. The SANalyzer <measurement> name is not used. DISP:ACP:ANN:TITL:DATA "" This example is for ACP; in measurements other than Swept SA the measurement name is required.
Notes	Uses the :DISPlay:<measurement>:ANNotation:TITLe:DATA <string> command with an empty string (in the Swept SA, the <measurement> is omitted).

Preset	Performed on Preset.
Initial S/W Revision	Prior to A.02.00

Graticule

Pressing Graticule turns the display graticule On or Off. It also turns the graticule y-axis annotation on and off.

Key Path	View/Display, Display
Remote Command	:DISPlay:WINDow[1]:TRACe:GRATicule:GRID[:STATe] OFF ON 0 1 :DISPlay:WINDow[1]:TRACe:GRATicule:GRID[:STATe]?
Example	DISP:WIND:TRAC:GRAT:GRID OFF
Notes	The graticule is the set of horizontal and vertical lines that make up the grid/divisions for the x-axis and y-axis.
Preset	On
State Saved	Saved in instrument state
Initial S/W Revision	Prior to A.02.00

System Display Settings

These settings are "Mode Global" – they affect all modes and measurements and are reset only by Restore Misc Defaults or Restore System Defaults under System.

Key Path	View/Display, Display
Initial S/W Revision	Prior to A.02.00

Annotation Local Settings

This is a Mode Global override of the meas local annotation settings. When it is All Off, it forces ScreenAnnotation, Meas Bar, Trace, and Active Function Values settings to be OFF for all measurements in all modes. This provides the security based "annotation off" function of previous analyzers; hence it uses the legacy SCPI command.

When it is All Off, the Screen, Meas Bar, Trace, and Active Function Values keys under the Display, Annotation menu are grayed out and forced to Off. When Local Settings is selected, you are able to set the local annotation settings on a measurement by measurement basis.

Key Path	View/Display, Display, System Display Settings
Remote Command	:DISPlay:WINDow[1]:ANNOtation[:ALL] OFF ON 0 1 :DISPlay:WINDow[1]:ANNOtation[:ALL]?
Example	:DISP:WIND:ANN OFF

Preset	On (Set by Restore Misc Defaults)
State Saved	Not saved in instrument state.
Backwards Compatibility Notes	The WINDOW parameter and optional subopcode is included for backwards compatibility but ignored – all windows are equally affected.
Initial S/W Revision	Prior to A.02.00

Themes

Accesses a menu of functions that enable you to choose the theme to be used when saving the screen image.

The **Themes** option is the same as the **Themes** option under the **Display** and **Page Setup** dialogs. It allows you to choose between themes to be used when saving the screen image.

Key Path	Save, Screen Image
Remote Command	:MMEMory:STORe:SCReen:THEMe TDColor TDMonochrome FCOLor FMONochrome :MMEMory:STORe:SCReen:THEMe?
Example	:MMEM:STOR:SCR:THEM TDM
Preset	3D Color; Is not part of Preset, but is reset by Restore Misc Defaults or Restore System Defaults All and survives subsequent running of the modes.
Readback	3D Color 3D Mono Flat Color Flat Mono
Backwards Compatibility Notes	In ESA and PSA we offer the choice of "Reverse Bitmap" or "Reverse Metafile" when saving screen images. This is much like the "Flat Color" theme available in X-Series. Also, if you selected Reverse Bitmap AND a black & white screen image, that would be much like "Flat Monochrome". In other words, each of the X-Series themes has a similar screen image type in ESA/PSA. But they are not identical.
Initial S/W Revision	Prior to A.02.00

3D Color

Selects a standard color theme with each object filled, shaded and colored as designed.

Key Path	Save, Screen Image, Themes
Example	MMEM:STOR:SCR:THEM TDC
Readback	3D Color
Initial S/W Revision	Prior to A.02.00

3D Monochrome

Selects a format that is like 3D color but shades of gray are used instead of colors.

Key Path	Save, Screen Image, Themes
Example	MMEM:STOR:SCR:THEM TDM
Readback	3D Mono
Initial S/W Revision	Prior to A.02.00

Flat Color

Selects a format that is best when the screen is to be printed on an ink printer.

Key Path	Save, Screen Image, Themes
Example	MMEM:STOR:SCR:THEM FCOL
Readback	Flat Color
Initial S/W Revision	Prior to A.02.00

Flat Monochrome

Selects a format that is like Flat Color. But only black is used (no colors, not even gray), and no fill.

Key Path	Save, Screen Image, Themes
Example	MMEM:STOR:SCR:THEM FMON
Readback	Flat Mono
Initial S/W Revision	Prior to A.02.00

I/Q Polar Vec/Constln

Specifies the format of the polar vector graph display. The following display options are available:

Vector and Constellation

Vector Only

Constellation Only

Key Path	View/Display
Mode	WCDMA, C2K, 1xEVDO
Remote Command	:DISPlay:EVMQpsk:VIEW[1]:WINDow2:TRACe:POLar VC VECTor CONSTln :DISPlay:EVMQpsk:VIEW[1]:WINDow2:TRACe:POLar?
Example	DISP:EVMQ:VIEW:WIND2:TRAC:POL VECT DISP:EVMQ:VIEW:WIND2:TRAC:POL?
Notes	Allows to specify the format of the polar vector graph display by: Vector and Constellation

	Vector Only Constellation Only
Preset	VC
State Saved	Saved in instrument state.
Range	Vec & ConstIn Vector Constellation
Readback Text	Vec & ConstIn Vector ConstIn
Initial S/W Revision	Prior to A.02.00

Chip Offset

Sets the chip offset number from the first chip in a measured signal.

Key Path	View/Display, Display
Mode	WCDMA, C2K, 1xEVDO
Remote Command	:DISPlay:EVMQpsk:VIEW[1]:WINDow2:TRACe:COFFset <integer> :DISPlay:EVMQpsk:VIEW[1]:WINDow2:TRACe:COFFset?
Example	DISP:EVMQ:VIEW:WIND2:TRAC:COFF 1001 DISP:EVMQ:VIEW:WIND2:TRAC:COFF?
Notes	The number of chip offset from the first chip in a measured signal.
Preset	0
State Saved	Saved in instrument state.
Min	0
Max	Meas Interval – I/Q Chips
Initial S/W Revision	Prior to A.02.00

I/Q Chips

Specifies the number of I/Q chips used to display the I/Q waveforms.

Key Path	View/Display, Display
Mode	WCDMA, C2K, 1xEVDO
Remote Command	:DISPlay:EVMQpsk:VIEW[1]:WINDow2:TRACe:IQCHips <integer> :DISPlay:EVMQpsk:VIEW[1]:WINDow2:TRACe:IQCHips?
Example	DISP:EVMQ:VIEW:WIND2:TRAC:IQCH 1001 DISP:EVMQ:VIEW:WIND2:TRAC:IQCH?
Couplings	This parameter is dependent on Meas Interval and cannot be set to a value greater than Meas Interval.
Preset	C2K: 512 WCDMA: 2560

	1xEVDO: 224
State Saved	Saved in instrument state.
Min	1
Max	WCDMA: 5120 C2K:1536
Initial S/W Revision	Prior to A.02.00

Interpolation

Toggles the interpolation function from On to Off. If set to On, the vector lines between chip dots are converted into smooth curves by the interpolation function.

Key Path	View/Display, Display
Mode	WCDMA, C2K, 1xEVDO
Remote Command	:DISPlay:EVMQpsk:VIEW[1]:WINDow2:TRACe:INTPolation[:STATe] OFF ON 0 1 :DISPlay:EVMQpsk:VIEW[1]:WINDow2:TRACe:INTPolation[:STATe]?
Example	DISP:EVMQ:VIEW:WIND2:TRAC:INTP ON DISP:EVMQ:VIEW:WIND2:TRAC:INTP?
Notes	If set to ON, the vector lines between chip dots are converted into smoothed curves by the interpolation function.
Preset	OFF
State Saved	Saved in instrument state.
Range	On Off
Initial S/W Revision	Prior to A.02.00

+45° Rotation

Toggles the state of the rotation of the I/Q polar trace. If set to On, the I/Q polar trace is rotated by 45 degrees to provide a rectangular display.

Key Path	View/Display, Display
Mode	WCDMA, C2K, 1xEVDO
Remote Command	:DISPlay:EVMQpsk:VIEW[1]:WINDow2:TRACe:ROTQpi[:STATe] OFF ON 0 1 :DISPlay:EVMQpsk:VIEW[1]:WINDow2:TRACe:ROTQpi[:STATe]?
Example	DISP:EVMQ:VIEW:WIND2:TRAC:ROTQ ON DISP:EVMQ:VIEW:WIND2:TRAC:ROTQ?
Notes	Enables you to toggle whether the I/Q polar trace is rotated by 45 degrees to provide a rectangular display.

Preset	OFF
State Saved	Saved in instrument state.
Range	On Off
Initial S/W Revision	Prior to A.02.00

Full Vector

Toggles the gray background from On to Off when displaying the full measured trace or the selected vector on the display.

Key Path	View/Display, Display
Mode	WCDMA, C2K, 1xEVDO
Remote Command	:DISPlay:EVMQpsk:VIEW[1]:WINDow2:TRACe:FVEctor[:STATe] OFF ON 0 1 :DISPlay:EVMQpsk:VIEW[1]:WINDow2:TRACe:FVEctor[:STATe]?
Example	DISP:EVMQ:VIEW:WIND2:TRAC:FVEC ON DISP:EVMQ:VIEW:WIND2:TRAC:FVEC?
Notes	This is useful when you want to observe the full vector and the selected vector set by I/Q Chips and Chip Offset simultaneously.
Preset	OFF
State Saved	Saved in instrument state.
Range	On Off
Initial S/W Revision	Prior to A.02.00

I/Q Error View

Provides a combination view. This view consists of four windows:

["Mag Error vs. Symbol Window" on page 2223](#)

["Phase Error vs. Symbol Window" on page 2223](#)

["EVM vs. Symbol Window" on page 2223](#)

["Numeric Results Window" on page 2224](#)

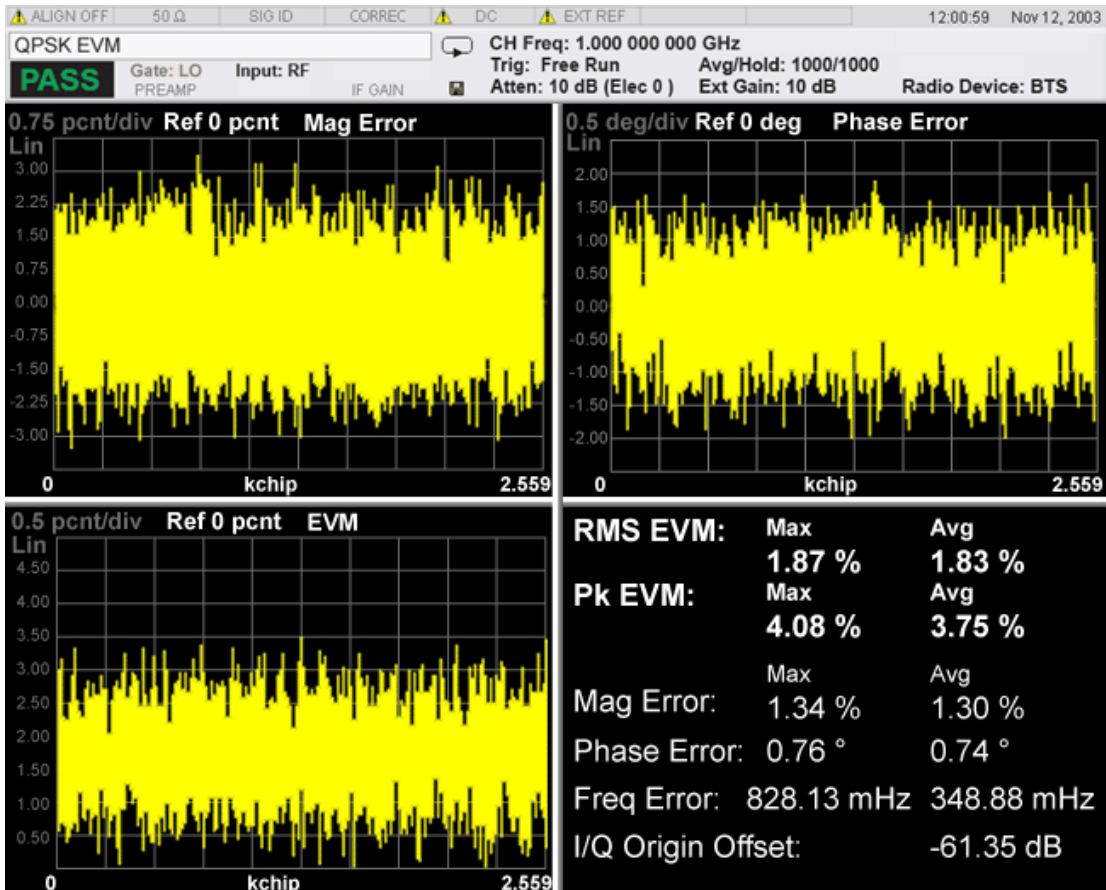

Figure 0-4 I/Q Error (Quad View)

Mag Error vs. Symbol Window

Provides Magnitude Error vs. Symbol results.

Marker Trace	Yes
Corresponding Trace	Magnitude Error trace (n=3)

Phase Error vs. Symbol Window

Provides Magnitude Error vs. Symbol results.

Marker Trace	Yes
Corresponding Trace	Phase Error trace (n=4)

EVM vs. Symbol Window

Provides EVM vs. Symbol results.

Marker Trace	Yes
Corresponding Trace	EVM trace (n=2)

Numeric Results Window

Shows numeric results as the same as the numeric results of the I/Q polar graph.

Key Path	View/Display
Initial S/W Revision	Prior to A.02.00



This information is subject to change without notice.

© Keysight Technologies 2015

Edition 1, August 2015

M9420-90010

www.keysight.com